



Telebit T2500
Fast Start Guide

90103-01 Rev. B

Telebit T2500

Fast Start Guide

90103-01 Rev. B





Preface

This guide is provided to help you quickly install and configure the T2500 modem. If you carefully follow the instructions in this booklet, you may not need to refer to the *T2500 Reference Manual* unless you have special requirements or need more specific instructions. However, we recommend that you spend some time reviewing that manual for additional information which is not covered in this guide.

Copyright © 1989 Telebit Corporation. Telebit is a registered trademark of Telebit Corporation. Other brands or product names are trademarks or registered trademarks of their respective holders.

Installation

Connecting the Modem

-  If you will be using the T2500 modem with a minicomputer or mainframe, you may need to first connect it to a terminal (or personal computer with a terminal emulation program) to preconfigure the modem before installing it in its final position.
-  Make sure that the power switch (1/0) on the rear of the modem is turned off (0). Connect the power cord provided with your modem to the POWER connector on the back of the modem. The beveled edge of the plug should be facing up so that it mates with the retainer clip on the connector. Plug the other end of the AC power cord into a grounded AC wall outlet (refer to Figure 1, T2500 Cable Connections).
-  Attach a standard (straight-through) shielded RS-232C modem cable between the RS-232C connectors on the modem and your computer or terminal. Your equipment dealer can help you obtain the correct cable for your specific requirements. If you have special cabling requirements refer to Appendix B in your T2500 Reference Manual.
-  Connect the telephone cable provided with your modem to the wall jack and to the TO LINE connector on your modem. Plug the larger (8 conductor) connector into the TO LINE jack on the modem.
-  Optionally, connect your telephone to the TO PHONE connector. This allows you to use the telephone for normal voice calls when the modem is not in use. You also can dial a number using the telephone then switch to data communications mode by pressing the T/D switch on the modem.

Note: the modem is equipped with a special phone cable which is designed to fit tightly into the rear panel RJ-45S jack. If you substitute your own cable, be certain that it fits tightly into the modem's TO LINE jack before attempting to use the modem. Loose connections may affect the modem's performance.

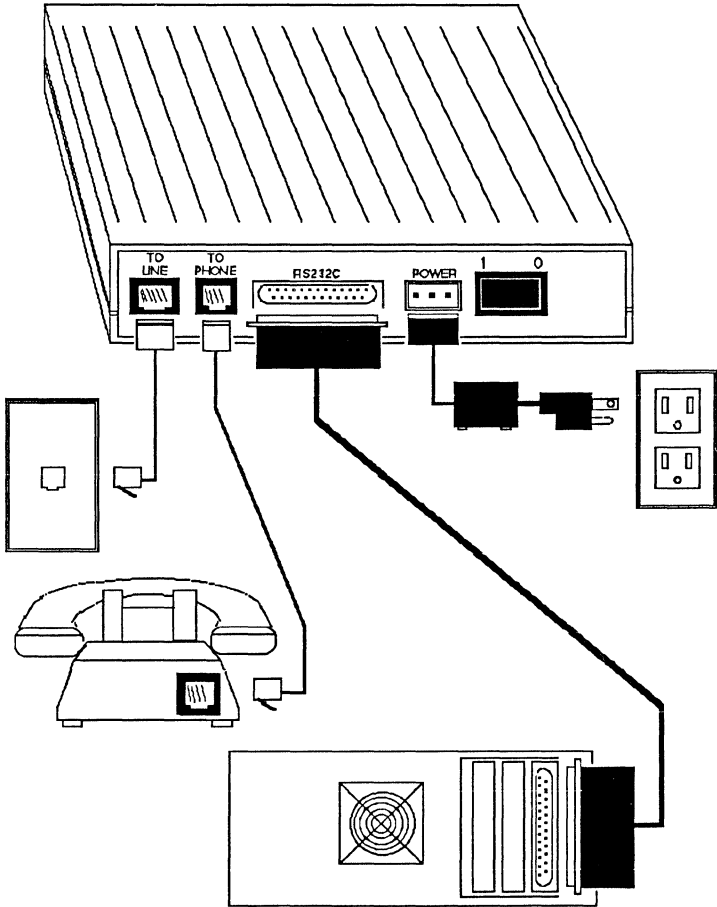

Figure 1. T2500 Cable Connections

Installation Verification Tests

Turn on the modem by pressing the power switch located on the back panel. The MR (Modem Ready) indicator should light after one or two seconds, indicating that the modem has completed a series of self diagnostic tests and is ready to use.

Press the T/D switch on the front of the modem. You should hear a dial tone from the modem's speaker. Press the T/D switch again to put the modem back on-hook. This indicates that the phone line is properly connected to the modem.

If you do not hear the dial tone, you may have the TO LINE and TO PHONE connections reversed. If this is the case, reconnect the lines properly and restart the verification tests.

If you have a telephone connected to the modem, lift the receiver on your telephone and listen for a dial tone. Press the T/D switch. The dial tone from the receiver should go away when the modem goes off-hook (OH indicator lit). Press the T/D switch again to put the modem back on-hook (OH indicator is off). The dial tone from the telephone receiver should return.

Operator Controls

A/B Profile Switch

The A/B switch is used to select one of two possible modem configurations, also called "profiles" (see Figures 2 and 3). When the modem is turned on, either Profile A or B is loaded from non-volatile memory depending on the setting of the A/B switch. Changing the position of the switch resets the modem and loads the new profile into memory. Either profile can be changed by saving the current operating parameters to non-volatile memory using the **AT &W** command. The modem is shipped from the factory with both Profiles (A and B) set for Asynchronous operation in Enhanced Command Mode.

T/D (Talk/Data) Switch

As you may have already noticed, the T/D switch controls the modem's connection to the telephone line much like the hook switch on your telephone.

If you press the switch while the modem is on-hook (OH indicator is off), the modem will go off-hook (it may attempt to connect in either originate or answer mode depending on the current setting of the S100 register). This allows you to manually place a call using the telephone set, then switch to data mode when the call is established.

If you press the switch while the modem is off-hook (OH indicator is on), the modem will go on-hook and either disconnect the call or switch to voice communications if you lift the telephone receiver before pressing the switch.

Memory Organization

Figure 2 shows the relationship between the active configuration (RAM), the factory defaults (ROM), and the non-volatile memory (EEPROM). The active configuration stored in RAM defines the current operating characteristics of the modem.

The factory defaults are the operating parameters most commonly used for data communications which are permanently stored in ROM. These parameters can be restored to the active configuration by issuing an **AT~&F** command as shown below, or by following the procedures described in the following section, *Default Configuration Selection*.

AT~&F0 = Asynchronous Enhanced Command Mode Parameters

AT~&F1 = Asynchronous Conventional Command Mode Parameters

AT~&F2 = PEP SDLC Parameters

AT~&F3 = V.32 Synchronous Parameters

The current operating parameters can be modified and saved in non-volatile memory as Profile A or Profile B via the **AT&W** command. Pressing the A/B switch resets the modem and loads the new profile into the active configuration. When a new Profile is selected, its settings replace the current operating parameters.

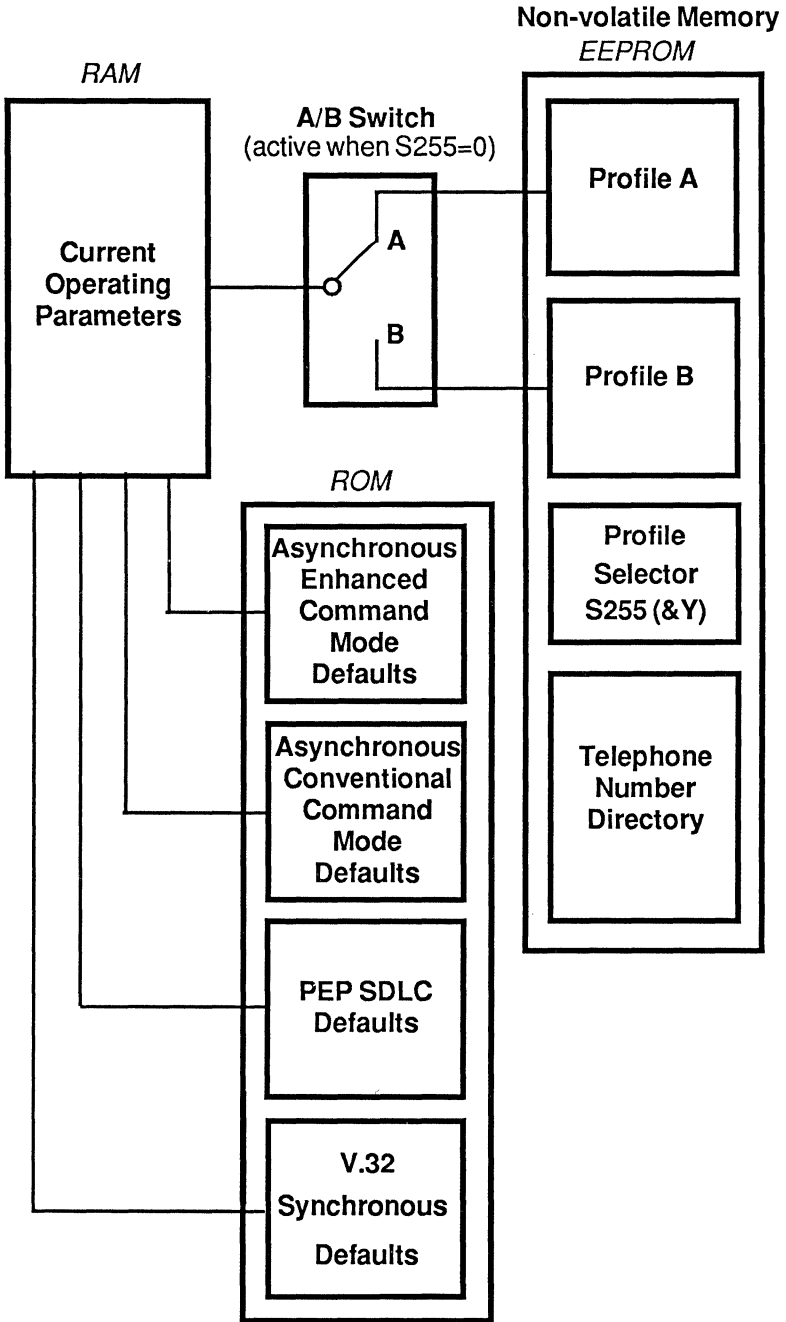

Figure 2. T2500 Memory Organization

Default Configuration Selection

The T2500 modem is supplied with four factory default configurations:

- Asynchronous Enhanced Command Mode
- Asynchronous Conventional Command Mode
- PEP SDLC
- V.32 Synchronous

Each default configuration of the modem can be selected via the Talk/Data switch. The LEDs provide a visual display of the configuration selected.

To load a default configuration into the T2500 non-volatile memory, follow the steps below. Figure 3 shows the various LED displays encountered while selecting a default configuration. *Note: if you are unsure which mode is appropriate for your application, refer to the guidelines in pages 9-17 of this manual.*

1. Turn off the modem power and determine the Profile you wish to re-initialize. If the configuration is to be stored in Profile A, set the A/B switch to position A. If the configuration is to be stored in Profile B, set the A/B switch to position B.
2. Enter the Configuration Select Mode by holding down the Talk/Data switch while turning on the power. Release the Talk/Data switch when the *PEP*, *CD*, and *MR* LEDs are flashing.
3. View the configurations by tapping the Talk/Data switch for less than two seconds. The LEDs will cycle through the various configurations (refer to figure 3).
4. When the LEDs indicate the desired configuration, make your selection by holding down the Talk/Data switch for more than two seconds. When your choice is accepted, the LEDs corresponding to the selected configuration will flash. Release the Talk/Data switch when the LEDs flash. The configuration will be stored in the Profile selected in Step 1.

Default settings are also loaded into the modem's current operating parameters except that the S0 register is set to 1 and the S45 register is set to 255, which enables auto-answer and remote access for Telebit Technical Support to remotely access your modem. If, however, you turn the modem power off then on, auto-answer will return to its default and remote access will no longer be enabled.

If Asynchronous Conventional Command Mode was selected, then the profile selector (&Y) will be set to match the position of the A/B switch. In all other cases, the S255 register will be set to 0, which causes the modem to select the Profile indicated by the A/B switch upon modem power-up.

When configuration selection is complete, the LEDs will go out, and the MR LED will light. The RAM and EEPROM memories have been updated, and the modem is now configured. Do not turn off the modem's power until the MR LED has re-illuminated.

Telebit T2500
(Front Panel)

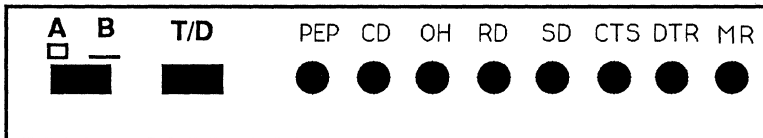

Asynchronous ECM	●							
Asynchronous CCM		●						
PEP SDLC	●	●						
V.32 Synchronous		●						●

ECM = Enhanced Command Mode
 CCM = Conventional Command Mode
 ● = LED ON

Figure 3. Default Configuration Display

Initializing the Modem for Asynchronous Operation

Selecting Conventional or Enhanced Command Mode

Before using your T2500 modem, you should determine which command mode will assure compatibility with your computer's data communications software.

Refer to the following table for instructions on how to initialize and configure your modem. If you will be using the modem with a personal computer, check your communications software manual for information on which modem(s) are supported by the software, or look for a setup option in the software which allows you to select the type of modem used.

If you are using a computer with communications software that supports Hayes® V-series™ modems:

Initialize the modem in Conventional Command Mode (page 7) and follow the instructions in your software manual to configure and use the modem. If you will be using a file transfer protocol such as X/Ymodem, UUCP, or Kermit, refer to the section *File Transfer Protocol Support* (page 15).

If you are using a computer with communications software that supports PEP modems such as the Telebit TrailBlazer Plus, T1000, T2000, T2500, DCA Fastlink, Racal-Milgo RM-1822D or Ven-Tel Pathfinder 18K:

Initialize the modem in Enhanced Command Mode (page 7) and follow the instructions in your software manual to configure and use the modem.

If you are using a personal computer with communications software that supports Hayes modems other than V-series or any other modem that uses AT commands:

Initialize the modem in Conventional Command Mode (page 7), then refer to the section *Personal Computer* (page 13) for further instructions on setting up your modem.

If you will be using the modem with a video display terminal (VDT or CRT):

Initialize the modem in Enhanced Command Mode (page 7), then refer to the section *Video Display Terminal* (page 11).

If you will be using the modem with a minicomputer or mainframe:

Initialize the modem in Enhanced Command Mode (page 7), then refer to the section *Minicomputer or Mainframe* (page 14).

Enhanced Command Mode

The T2500 modem is shipped from the factory initialized to power up in Enhanced Command Mode when the A/B switch is in the A or B position. If you have determined that this is appropriate for your requirements, then no special action is necessary, provided that no one has changed the register settings in non-volatile memory.

To ensure that the modem is operating in Enhanced Command Mode you can reset the modem as described in *Default Configuration Selection*, page 7. This stores the Enhanced Command Mode default settings in the selected profile of non-volatile memory. These default settings are also loaded into the modem's current operating parameters except that the S45 register is set to 255 which enables remote access for Technical Support to remotely access your modem. However, if you turn the modem power off then on, remote access will no longer be enabled.

If you will be using data communications software which supports PEP modems such as the Telebit T1000, T2000, T2500, or TrailBlazer Plus, set the modem to the Enhanced Command Mode and follow the instructions in your software manual to configure and use the modem.

Conventional Command Mode

If you have decided that Conventional Command Mode is preferable, then reset the modem as described in *Default Configuration Selection* (page 7). This stores the Conventional Command Mode default settings in the selected profile of non-volatile memory. These default settings are also loaded into the modem's current operating parameters except that the S0 register is set to 1 and the S45 register is set to 255, which enables auto-answer and remote access for Telebit Technical Support to remotely access your modem. If, however, you turn the modem power off then on, auto-answer and remote access will no longer be enabled.

To take advantage of the T2500 features which are normally not accessible in Conventional Command Mode, a special access character (~) allows you to access Enhanced Command Mode features while remaining in Conventional Command Mode.

If you will be using data communications software which supports Hayes® V-series™ modems, follow the instructions in your software manual to configure and use the modem.

Recommended Configurations for Asynchronous Operation

This section includes some recommended configurations for several specific environments. However, depending on your equipment, there may be exceptions to the following recommendations. See the *T2500 Reference Manual* for more detail regarding configuration options.

Video Display Terminal

When the T2500 modem is connected to a video display terminal, you can simply enter commands from the keyboard to configure the modem and dial or answer a call.

Preconfiguring the Modem

Set your terminal serial port speed to 9600 or 19,200 bps and enter the following command line:

AT ~&F S66=1 &W

This command line locks the interface speed between your modem and terminal, and uses XON/XOFF flow control to regulate the data transmitted to the remote modem (when it is slower).

If you have an HP terminal dialing into an HP 1000/3000, configure your modem as described above, then enter the following command line:

AT ~ S58=5 S68=0 &W

The modem automatically answers an incoming call after the number of rings specified by the S0 register. To disable auto-answer, enter the following command line:

AT S0=0 &W

Enter **AT ~&N** to verify your configuration when finished. The **&N** command will cause the modem to display the number directory and contents of the S registers in the currently selected profile.

Dialing a Call

Note: Some systems use the "callback" procedure to maintain security. Prior to calling a system that uses a call back function, therefore, verify that the S0 register is set to 1. This allows the modem to automatically answer the incoming call after the first ring.

To call another modem using tone dialing, enter **AT DT** followed by the telephone number to be called. For example:

AT DT 555-6789

If you will be dialing through a PBX or have other special dialing requirements, refer to your *T2500 Reference Manual* for additional information on dialing.

Personal Computer

This section assumes that you are using data communications software which supports Hayes modems other than V-series and that your modem has been initialized for Conventional Command Mode. If your software supports Hayes V-series modems or PEP modems, you can simply follow the instructions in your communications software user's manual to configure and use the modem.

Many communications software programs expect certain modem operating characteristics to be preset either by switches or **AT** commands before the modem can be used. If your software uses the RS-232 signals DTR and DCD, place your software in direct connect mode (the mode which allows you to send commands directly to the modem), and enter the following command line:

AT &C1 &D2 &W

If you are using a Macintosh computer or any other system that does not use the RTS and CTS flow control signals, you must also enter **AT &K0 &W** (no flow control) or **AT &K4 &W** (XON/XOFF flow control). Check your computer manual to determine if it supports RTS/CTS flow control (hardware).

If you will be using a file transfer protocol such as X/Ymodem, Kermit, or UUCP, refer to the section *File Transfer Protocol Support* (page 15).

Enter **AT &V** to verify your configuration when finished. This command will cause the modem to display configurations and user profiles.

If your software has a setup option which allows you to choose the type of modem, select a Hayes® Smartmodem™ (preferably the 2400). Most communication programs use the Hayes modem configuration parameters as the default. If you do not have a choice of modems, try using the software default settings.

If you have problems while using the modem, refer to the section *Common Problems* at the end of this guide for possible solutions.

Minicomputer or Mainframe

In general, if you plan to use the modem with a minicomputer or mainframe, it should be preconfigured using a terminal (or personal computer with a terminal emulation program). When finished, enter **AT ~ &N** to verify your configuration.

Fixed Speed Configuration

If your system is not capable of automatically detecting the interface speed on incoming calls, set your terminal to operate at 19,200 bps and enter the following commands on a single line:

**AT ~ &F S51=5 S52=1 S54=3 S55=3 S58=3 S64=1 S66=1
S67=1 S130=5 S131=1 Q4 E0 &W**

This configuration assumes that your computer is set to run at 19,200 bps and uses XON/XOFF flow control. If your system supports RTS and CTS control signals, you should set S58 to 2 to use RTS and CTS flow control. If your system runs at 9600 bps, set S51=4.

Listed below are some additions pertaining to specific environments. These additions assume that you have preconfigured the modem as described above. Turn echo back on by entering an **AT E1** command, then enter the appropriate command line:

VAX/DECnet	AT ~ S58=0 S68=3 E0 &W
UNIX/UUCP	AT ~ S58=0 S68=3 S111=30 E0 &W
HP 1000/3000	AT ~ S58=0 S68=5 E0 &W
HP Terminal	AT ~ S58=5 S68=0 E0 &W

Automatic Speed Detection Configuration

If your system is capable of automatically detecting the interface speed on incoming calls, enter the following commands on a single line:

**AT ~ &F S51=254 S52=2 S54=3 S55=3 S64=1
S130=5 S131=1 Q4 E0 &W**

If you have a UNIX system with Honey DanBer UUCP, set S111=30, S130=2, and S131=2.

File Transfer Protocol Support

When file transfer protocol support is enabled, the modem interacts with the protocol to eliminate delays in the file transfer which normally occur with other high-speed modems. This significantly increases the data throughput rate without altering the protocol functionality.

The modem can be configured to provide protocol support for the following file transfer protocols when a connection is made in PEP mode:

- Kermit
- X/Ymodem
- UUCP

During the connection initialization sequence, the modems at both ends will negotiate which protocol they will use to communicate.

Protocol support is an Enhanced feature which is controlled by the S111 register. To set this register, place your communications software in direct connect mode (the mode that allows you to send commands to the modem), and issue the following command line where n specifies the protocol to support:

AT ~S111=n &W

Refer to the description of the S111 register in Section 5C of the *T2500 Reference Manual* for specific settings.

Note to UUCP Users:

For additional information when configuring the modem for UUCP protocol support send an electronic mail request to:

{ames, sun,uunet}!telebit!modems

or call your Technical Support representative. Also refer to the Nutshell handbook entitled *Managing UUCP and Usenet*,

published by O'Reilly and Associates, Inc.

Note to Kermit Users:

Kermits that use sliding windows or large blocks may be used with protocol support. However, the modem modifies the "S" packet exchange forcing regular Kermit (no windows, 94 byte maximum packet size) to be negotiated between both computers. The CTRL-X and CTRL-Z options for interrupting file transfer operations are not supported when used to interrupt the reception of a file. However, these two options can be used to interrupt the transmission of a file.

PEP SDLC Operation

PEP SDLC operation allows the fastest IBM Systems Networking Architecture (SNA) SDLC synchronous dial-up connections possible, while providing the error immunity features of Packetized Ensemble Protocol™ (PEP) operation. To initialize the modem in PEP SDLC operation, refer to *Default Configuration Selection*, page 7.

SDLC Configuration Procedure

If you need to change the SDLC operating parameters, perform the following steps to preconfigure the modem using an asynchronous terminal (or personal computer).

1. Initialize the modem for PEP SDLC as described on page 7.
2. Configure the modem for your specific requirements by entering **AT** followed by the T2500 register settings indicated in Table 1.
3. Issue the following command line to save and verify the current configuration in the desired profile:

AT &W &N

You can now connect the modem to your SDLC equipment. The next time you turn on the modem with the A/B switch in the same position as selected for the procedure above, it will operate with PEP SDLC.

ACF/NCP/VS Macro	T2500 Register Setting
GROUP	
or ,DIAL=YES or ,DIAL=NO ,LNCTL=SDLC ,MODE=PRI ,REPLYTO=10 ,TYPE=NCP	S152=1 S152=0 S150=1
LINE	
or ,ANSTONE=NO or ,AUTO=address (AUTO omitted) ,CALL=IN or ,CALL=INOUT or ,CALL=OUT or ,CLOCKING=EXT or ,CLOCKING=INT or ,DUPLEX=HALF or ,DUPLEX=FULL ,LPDATS=NO ,MAXPU=1 ,NEWSYNC=N ,NRZI=NO ,NRZI=YES ,RETRIES=10 ,RING=YES or ,SPEED=19200 or ,SPEED=9600 or ,SPEED=4800 or ,SPEED=2400 or ,SPEED=1200	S102=2 S102=0 S0=1 S0=1 S0=0 S154=0 S154=1 S153=1 S153=0 S155=0 S155=1 S151=5 S151=4 S151=3 S151=2 S151=1

Table 1. SDLC Configuration Cross Reference
 (Boldface values represent default settings)

Common Problems

This section covers several of the most common problems that you may encounter while using the modem. For additional problem solving information, refer to *Diagnostics and Service* in your *T2500 Reference Manual*.

Modem is not responding correctly to AT commands:

Verify that the MR (Modem Ready) indicator is lit. If not, try powering the modem off and then on again. After a 2 second delay, the indicator should light. If the indicator still does not light, try issuing an **AT II** command. If you do not get a 000 response code from the modem, contact your Technical Support representative for assistance.

Reinitialize the modem for either Enhanced or Conventional Command Mode (see *Default Configuration Selection*, page 7).

If you still get no response, contact your Technical Support representative for assistance.

Modem will not answer an incoming call:

Verify that the modem's S0 register is not set to 0.

If the S52 register is set to 1 or 2, verify that DTR (Data Terminal Ready) from the terminal or personal computer is up when the call comes in. This is indicated by the DTR light on the modem. Either change your DTE (Data Terminal Equipment) configuration to raise DTR or set the modem's S52 register to 0. Changing the setting of the S130 or S131 registers may cause the DTE to raise the DTR signal.

Modem answers, then hangs up immediately:

Make sure that your DTE is not transmitting any data before DCD (Data Carrier Detect) is turned on. Also, if the modem is configured to show status messages, such as RING, your DTE may be echoing the message back to the modem. In any case, the modem will hang up if it receives data while answering or originating a call. Issuing an **AT E0 Q1 S64=1** command should eliminate these problems.

Make sure that your DTE is not dropping DTR during the call. If the S52 register is set to 1 or 2 and DTR is dropped, the modem will hang up. Either configure the DTE to not randomly drop DTR or set the S52 register to 0. Changing the settings of the S130 or S131 registers may help force the DTE to keep the DTR signal active.

The modem normally answers a call with special PEP answer tones first. If it does not get a response to the PEP tones, it then tries answering with slower speed modem answer tones. Some slower speed modems may be adversely affected by the PEP answer tones. Setting the S92 register to 1 solves this problem by moving the PEP answer tones to the end of the answer sequence. Refer to the S92 register description in your *T2500 Reference Manual* for additional information.

Data is garbled during transmission:

When a connection is made at V.32 or low speeds (300, 1200 or 2400 bps), poor line quality may cause transmission errors. However, if the problem appears to be more serious than occasional transmission interference, you may have a configuration problem.

Verify that the data format (data length, parity, and stop bits) used by both the local and remote DTE match.

When a connection is made in V.32 or Low Speed Mode while S66=0, the modem changes its interface speed to match the speed of the connection. The DTE must also change its serial port speed, otherwise, data may be lost or garbled. Set S66=1 to lock the modem's interface speed and use flow control. Registers S58 and S68 determine which flow control method to use.

Data is lost during transmission:

Lost data usually indicates that some kind of problem with flow control.

You may have a mismatch of flow control methods used by your DTE and the modem. The two most common methods supported by the modem are XON/XOFF (software flow control) or RTS/CTS (hardware flow control). Set the S58 and S68 registers to

match the flow control method used by your DTE.

When transmitting non-ASCII and binary data, XON/XOFF flow control (S58=3 or 4) should be avoided and the escape character should be sent in sequence with the data stream (S55=3). This prevents the modem from mistakenly trapping the escape, XON or XOFF character patterns causing data to be lost. If the use of XON/XOFF flow control is unavoidable, try setting the S48 register to 1.

If possible, RTS/CTS flow control should be used for transmitting non-ASCII and binary files. However, if this is not feasible, you can use the following register settings to transmit non-ASCII data using XON/XOFF flow control:

Transmit Site: S58=0 S68=3 S55=3

Receive Site: S58=3 S68=0

This configuration assumes that file transmission is only in one direction. The acknowledgement message cannot contain XON or XOFF characters.

Data transmission unexpectedly stops:

One of the modems may have been inadvertently placed in command mode either by a break signal or escape sequence. This problem can be corrected by setting the S54 and S55 registers to 3. These registers determine how the modem interprets break and escape characters.

Another possibility is that one of the modems may have erroneously detected an XOFF. This is most likely to occur while transmitting non-ASCII and binary data. Try setting the S48 register to 1. This allows the modem to examine all eight bits to detect an escape, XON or XOFF. If you must use XON/XOFF flow control while transmitting non-ASCII files, see the above guidelines for additional information.



