



# LINEAR AND DIGITAL SEMI-CUSTOM IC DESIGN PROGRAMS

*First in Quality...First in Service • Custom, Semi-custom and Standard IC's*

**GRAHAM ELECTRONICS**  
3697 Corporate Drive Bldg. 3  
Columbus, Ohio 43229  
Phone (614) 895-1590



# Introduction

This semi-custom IC design brochure contains a complete outline and summary of Exar's unique semi-custom IC design, development, and production program and capabilities. This technique, which was pioneered by Exar, offers a unique and effective method of manufacturing an almost unlimited variety of custom linear or digital monolithic IC's with greatly reduced cost and development times. Exar makes this possible by stocking wafers that are completely fabricated except for the final process step of device interconnection which metalizes all selected components together in the required circuit configuration. This enables an engineer to design a metal mask based on his circuit which will interconnect "uncommitted" components on the prefabricated wafers.

The semi-custom program, is intended for those customers seeking cost-effective solutions to reduce component count and board size in order to compete more effectively in a changing marketplace. The program allows a customized monolithic IC to be developed with a turn-around time of several weeks and at a small fraction of the cost of a full custom development program.

Exar's semi-custom design programs cover both the conventional bipolar as well as the integrated injection logic (I<sup>2</sup>L) technologies. In each of these technology areas, Exar has developed a number of monolithic semi-custom chips, called "Master Chips." This brochure reviews the features and the capabilities of these Master Chips to enable the user to choose the right chip for his semi-custom program.

## EXPERIENCE AND PRODUCTS

Since the introduction of the semi-custom technology by Exar in 1971, we have successfully designed or completed over 300 semi-custom IC products which cover a wide range of applications and a very broad customer base. However, Exar's experience and expertise in the area of bipolar and I<sup>2</sup>L technologies extend well beyond semi-custom designs to a wide range of standard IC products. Today Exar has one of the most complete product lines of IC oscillators, timing circuits and phase-locked loops. In the field of industrial control circuits, Exar manufactures a broad line of quad and dual operational amplifiers, remote-control and servo driver IC's and power control circuits.

## EXCELLENCE IN ENGINEERING

Exar quality starts in Engineering where highly qualified people are backed up with the advanced instruments and facilities needed for design and manufacture of custom, semi-custom, and standard integrated circuits. Exar's engineering and facilities are geared to handle all three classes of IC design: (1) semi-custom design programs using Exar's bipolar and I<sup>2</sup>L

master chips; (2) full-custom IC design; (3) development and high-volume production of standard products.

Some of the challenging and complex development programs successfully completed by Exar include analog comparators and PCM repeaters for telecommunication, electronic fuel-injection, anti-skid braking systems and voltage regulators for automotive electronics, digital voltmeter circuits, 40 MHz frequency synthesizers, high-current and high-voltage display and relay driver IC's, and many others.

## NEW TECHNOLOGIES

Through company sponsored research and development activities, Exar constantly stays abreast of all technology areas related to changing customer needs and requirements. Exar has recently completed development efforts in Integrated Injection Logic (I<sup>2</sup>L) technology, which offers unique advantages in the area of low-power, high-density logic arrays. Exar has a complete design engineering group dedicated to this new technology, and is currently supplying over thirty different custom and semi-custom I<sup>2</sup>L products.

## FIRST IN QUALITY

From incoming inspection of all materials to the final test of the finished goods, Exar performs sample testing of each lot to ensure that every product meets Exar's high quality standards. Exar's manufacturing process is inspected or tested in accordance with its own stringent Quality Assurance Program, which is in compliance with MIL-Q9858A. Additional special screening and testing can be negotiated to meet individual customer requirements.

Throughout the wafer fab and assembly process, the latest scientific instruments, such as scanning electron microscopes, are used for inspection, and modern automated equipment is used for wafer probe, AC, DC, and functional testing. Environmental and burn-in testing of finished products is also done in-house. For special environmental or high reliability burn-in tests outside testing laboratories are used to complement Exar's own extensive in-house facilities.

## FIRST IN SERVICE

Exar has the ability and flexibility to serve the customer in a variety of ways from wafer fabrication to full parametric selection of assembled units for individual customer requirements. Special marking, special packaging and military screening are only a few of the service options available from Exar. We are certain that Exar's service is flexible enough to satisfy 99% of customer needs. The company has a large staff of Applications Engineers to assist the customer in the use of the product and to handle any request, large or small.

---

Exar reserves the right to make changes at any time in order to improve design and to supply the best product possible.

Exar cannot assume any responsibility for any circuits shown or represent that they are free from patent infringement.

# Table of Contents

	Page
SEMI-CUSTOM DESIGN CONCEPT .....	2
ANSWERS TO FREQUENTLY ASKED QUESTIONS .....	4
ECONOMICS OF SEMI-CUSTOM DESIGN .....	6
CONVERTING SEMI-CUSTOM TO FULL CUSTOM .....	7
FULL CUSTOM DEVELOPMENT .....	8
TESTING OF SEMI-CUSTOM IC's .....	9
LINEAR SEMI-CUSTOM DESIGN .....	10
XR-A100 Master Chip .....	12
XR-B100 Master Chip .....	13
XR-C100A Master Chip .....	14
XR-D100 Master Chip .....	15
XR-F100 Master Chip .....	16
XR-G100 Master Chip .....	17
Linear Semi-Custom Design Cycle .....	18
Linear Design Kit .....	20
Components in Linear Design Kit .....	21
Electrical Characteristics of Linear Master Chip Components .....	22
DIGITAL SEMI-CUSTOM DESIGN .....	24
Features of I <sup>2</sup> L Technology .....	25
Designing with I <sup>2</sup> L Master Chips .....	26
XR-200 I <sup>2</sup> Master Chip .....	29
XR-300 I <sup>2</sup> L Master Chip .....	30
XR-400 I <sup>2</sup> L Master Chip .....	31
XR-500 I <sup>2</sup> L Master Chip .....	32
I <sup>2</sup> L Semi-Custom Design Cycle .....	33
Exar's Semi-Custom I <sup>2</sup> L Programs .....	34
I <sup>2</sup> L Design Kit .....	35
Components in I <sup>2</sup> L Design Kit .....	36
XR-C409 I <sup>2</sup> L Evaluation Circuit .....	37
Electrical Characteristics of I <sup>2</sup> L Master Chips .....	38
Typical Performance Characteristics of I <sup>2</sup> L Gates .....	39
QUALITY ASSURANCE STANDARDS .....	40
MONOLITHIC CHIPS FOR HYBRID ASSEMBLIES .....	41
Package Types for Semi-Custom Designs .....	42
Foreign Sales Offices .....	44

# Semi-Custom Design Concept

Traditionally, the development of custom IC's has been a long and costly undertaking: the development time would normally run in excess of one year; design changes are slow and costly, and it may take a long time to get from prototype to full production. Because of these difficulties, the use of custom IC's could be economically justified only when a very large quantity of circuits, i.e., several hundred-thousand or more units, were required during the life of the end product. In the past, these drawbacks have severely limited the use of custom monolithic IC's.

The semi-custom design concept, pioneered by Exar, now overcomes this traditional problem. Exar makes this possible by stocking wafers that are completely fabricated except for the final process step of device interconnection which metalizes all selected components together in the required circuit configuration. This enables an engineer to design a metal mask based on his circuit which will interconnect the *uncommitted* components on the prefabricated wafers, and thus convert them into *customized* chips corresponding to the customer's design. This unique method of IC design and development allows one to develop an almost unlimited variety of custom linear or digital integrated circuits at very substantial cost savings.

The semi-custom program, is intended for those customers seeking cost-effective solutions to reduce component count and board size in order to compete more effectively in a changing marketplace. The program allows a customized monolithic IC to be developed with a turn-around time of several weeks, at approximately 10% to 20% of the development of tooling costs associated with the conventional full custom designs. The semi-custom design concept is an interactive or co-operative development effort between Exar and

the customer. In most cases, the cost and the development time for the program can be reduced even further by having the customer do the design and breadboarding of his own semi-custom IC, using Exar's Design Kits, instruction manuals and layout sheets.

The semi-custom design approach is based on a number of standardized IC chips with fixed component locations. These standardized IC chips, called Master Chips, contain a large number of *undedicated* active and passive components (i.e., transistors, resistors, logic gates etc.). These integrated components can be interconnected in thousands of different ways, with a *customizing* interconnection pattern. Each different metal interconnection pattern creates a new custom IC. The figures below show the magnified photograph of such a Master Chip both at its *prefabricated* form, and after its customization with a special interconnection pattern, which converts it to a completed custom chip. This method is called *semi-custom*, rather than *full custom* since only the last layer of tooling is changed to customize an IC chip, and the rest of the layers are standard. As a result, the development phase is very short, far less expensive and risk free, compared to conventional full- or dedicated-custom IC's. Similarly, if a design change or iteration is necessary, it can be readily accommodated, within a matter of weeks, by simply generating a new or modified interconnection pattern.

Exar offers a wide choice of Master Chips for linear and digital semi-custom design: At present there are five bipolar Master Chips aimed primarily for linear design, and three I<sup>2</sup>L Master Chips for digital or analog/digital LSI design. Additional chips are under development for a variety of special applications. The details of each of these chips are discussed further in the later sections of this brochure.

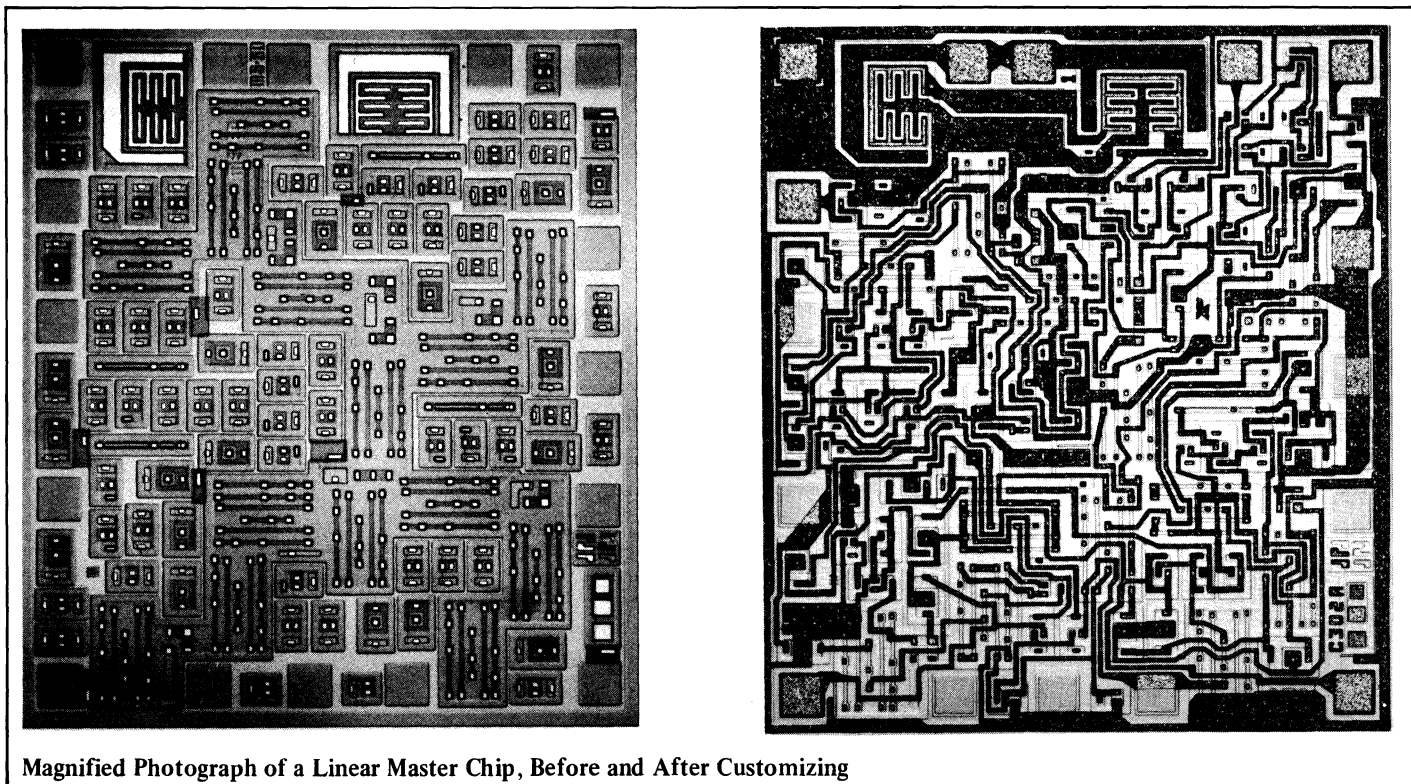



## SEMI-CUSTOM DESIGN KITS

Exar offers *two* semi-custom "Design Kits," one intended for linear or analog circuits, and the other for digital designs. The linear design kit is based on Exar's bipolar linear IC design and fabrication technology. The digital design kit is derived from Exar's integrated injection logic or I<sup>2</sup>L technology. Each of these kits contain a comprehensive instruction manual, a set of layout sheets and a large number of monolithic circuit components or "kit parts" which consist of transistor and resistor arrays and logic subblocks. This provides the design engineer with the ability to evaluate and characterize his design using the same "breadboarding" techniques as used in conventional (i.e., non-integrated) designs. Except, in this case, monolithic IC kit parts are used for the critical circuit components. Since these kit parts exhibit electrical characteristics which are nearly identical to those on the final monolithic IC, they provide an accurate simulation of the final circuit performance during this breadboard analysis stage. Once the breadboard evaluation is satisfactorily completed, he can then proceed to do his own IC layout using the layout sheets and the instructions included in the Design Manual supplied as a part of the Kit.

Semi-custom design is a straight-forward technique: it is basically no more than simply interconnecting a number of pre-fabricated circuit components on a monolithic chip. In this sense, it is similar to conventional printed circuit board layout once the circuit is designed, breadboarded and evaluated for "worst-case" component tolerances. The availability of a complete Design Kit allows the customer the choice of designing his own semi-custom IC, in consultation with Exar, and then submit Exar a completed pencil layout of his circuit, on the appropriate Master Chip overlay. Exar would then review this layout for feasibility and accuracy and proceed to generate the necessary final tooling to customize the monolithic chip. This "interactive" design approach where the customer can do his own design and layout using one of Exar's Design Kits can save significant development cost and time. These Design Kits also provide an excellent training aid for circuits and systems designers in familiarizing themselves with the basics of monolithic IC design.

## YOUR FIRST STEP

Your very first step, at the start of the semi-custom program, should be to contact Exar for a preliminary analysis and discussion of your needs. This can be done even while the program is still at the "thought stage." This initial review by Exar is performed at no cost to the customer. Yet it is essential to the success of the program since it avoids any possible design pitfalls or misunderstandings. This early interaction also allows you to find out some of the options or variations available in Exar's semi-custom programs and choose the one which is best suited to your needs.

The following is a typical check list of items and information which is required by Exar's technical staff to provide you with an accurate feasibility study of your project along with a budgetary estimate of the development costs, time tables and production pricing.

- A block diagram of circuit function, and input/output interface requirements.
- A circuit schematic or logic diagram of your circuit.
- Preliminary or objective performance specifications, limits on critical circuit parameters (also possible trade-offs which may be allowed).
- Types of electrical testing required for production units (i.e., AC or DC parametric testing, functional testing etc.).
- Production quantity requirements.
- Desired development and production time tables.
- An indication of how much of the breadboarding, layout etc. can be done by you the customer, using Exar's Design Kits.

Once the above data package is submitted to Exar, we would review it and respond to you with a feasibility assessment and a budgetary cost and price estimate for your semi-custom program, within a few days after the receipt of the above information package.

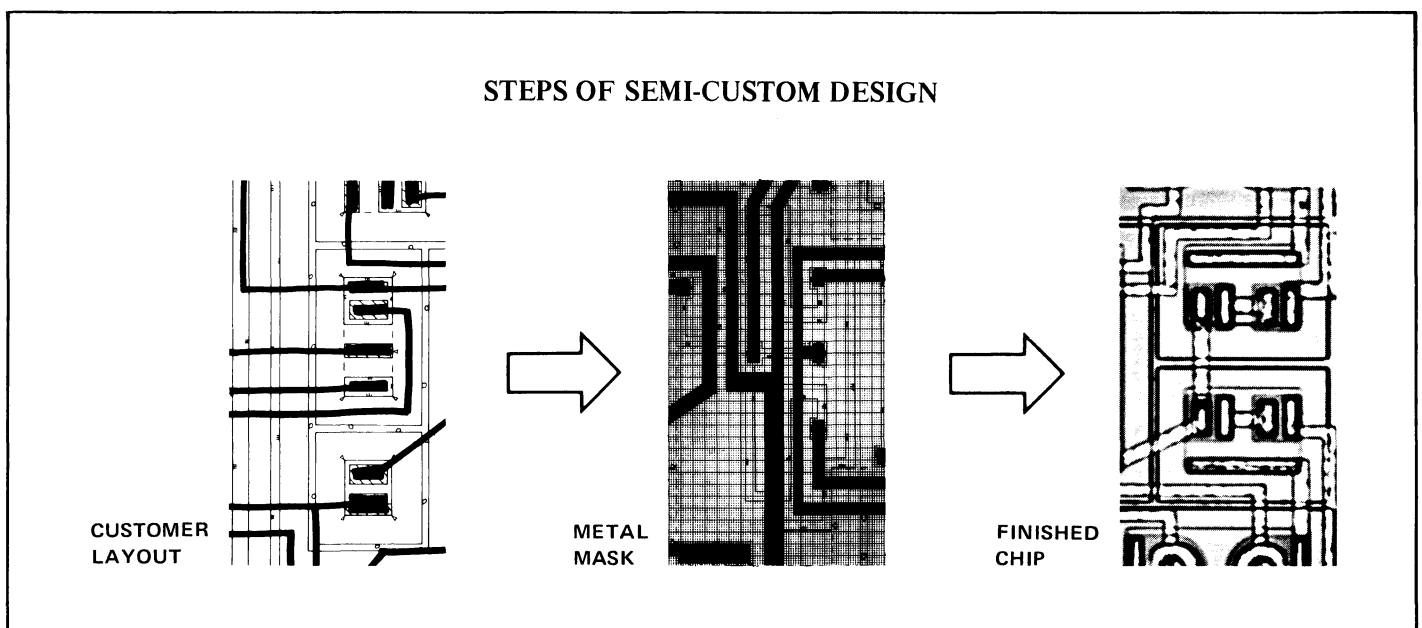

# Answers to Frequently Asked Questions

Based on our long experience with Exar's bipolar and I<sup>2</sup>L semi-custom Master Chips, we have compiled a comprehensive glossary of the "most often asked questions" concerning the program. The following is a list of these questions and their answers:

## WHAT IS THE COST OF THE BASIC PROGRAM?

The cost of the semi-custom development program depends on how much of the design and the layout is done by the customer, using Exar's design kits. In general, the "basic" semi-custom program where the customer does the design, breadboard evaluation and the pencil layout on the Master Chip worksheet, and Exar only does the IC tooling and the prototype fabrication, is the most economical and cost effective approach.

In the case of the bipolar semi-custom designs, the development cost for the basic program is in the range of \$3,000 to \$5,000, starting with an accurate layout supplied by the customer. The above prices also include the cost of 50 monolithic prototypes delivered at the completion of the program. Additional prototypes are available at a nominal cost, in minimum lots of 200 units.

In the case of the I<sup>2</sup>L semi-custom designs, the basic development program costs are in the range of \$5,000 to \$10,000, depending on the layout complexity and the particular Master Chip used. This development cost also includes 25 monolithic prototypes. Additional prototypes are available at a nominal cost, in minimum lots of 100 units each.

## WHAT IS THE DEVELOPMENT TIME?

Typical development time for the basic bipolar semi-custom program is *six to eight* weeks, starting with the customer's pencil layout and ending with the monolithic prototypes. If Exar is required to do the IC layout or breadboard evaluation, several additional weeks may be required to complete the development program.

In the case of I<sup>2</sup>L semi-custom development programs, typical development time is *eight to fourteen* weeks, starting with the pencil layout on the Master Chip worksheet. The I<sup>2</sup>L semi-custom program takes slightly longer than bipolar because it requires three layers of custom tooling, rather than one, to customize a prefabricated Master Chip.

## WHAT IF ADDITIONAL DESIGN CYCLES ARE NEEDED?

Upon evaluation of the initial prototypes, if the customer desires to modify the design or the layout, a new design iteration cycle can be completed within *five* weeks for the bipolar designs, and within *eight to ten* weeks for the I<sup>2</sup>L designs.

Typical costs of additional design cycles are \$2,000 to \$3,000 for bipolar designs and \$3,500 to \$5,000 for I<sup>2</sup>L designs. These costs also include the additional prototypes supplied at the completion of the design iteration cycle.

## WHAT ABOUT PRODUCTION PRICING?

The production pricing of monolithic IC's depend on a number of important factors such as:

- a) Circuit complexity (i.e., yield)
- b) Device performance and test requirements
- d) Special environmental screening requirements (burn-in, hermeticity tests etc.)
- e) Package type required

In the case of a custom IC, it is impossible to anticipate the impact of these factors in advance, since each custom IC by definition, has some unique requirement or feature associated with it. After reviewing your specific needs, particularly with regards to the circuit performance and the quantity requirements, Exar can provide you with a detailed proposal outlining the cost breakdown and the production pricing for your particular circuit.

## WHAT ABOUT TESTING OF SEMI-CUSTOM IC'S?

The initial monolithic prototypes supplied to the customer at the conclusion of the basic semi-custom program are not electrically tested. However, upon evaluation of these prototypes and the definition of test specifications by the customer, Exar can develop test software and fixtures to provide fully tested production IC's. All production devices receive 100% electrical test and screening to a mutually agreed upon device specification. In addition to the complete electrical testing, all of the production devices are screened by Exar's Quality Assurance Department to assure compliance with the agreed-upon Acceptable Quality Level (AQL) Standards.

There is normally a non-recurring engineering charge associated with this test system generation, to cover the cost of the test fixture and the computer software development. Depending on the complexity of the test requirements, this test-engineering charge is normally in the range of \$1,000 to \$4,000.

Exar can perform two basic types of tests for production IC's: (1) parametric testing which measures a specific parameter value (normally current or voltage) and compares it against pre-established limits; (2) functional testing which applies a series of operating conditions and compares the circuit under test with a known good device. These two types of tests can be performed both as steady state (DC) or dynamic (AC) measurements. Although DC tests are easily implemented by automated testers, AC tests are usually difficult and expensive to perform in production.

Test system development cost is not included in the basic semi-custom development program. This development effort usually requires *four to six* weeks to complete, and is normally not initiated until the evaluation and the approval of the initial IC prototypes. However, if a definite production commitment is made at the commencement of the semi-custom development program, the test system development effort can be initiated in parallel with the chip development effort. Exar has a complete computer-controlled IC test facility, and offers complete IC testing capability for production units. A detailed description of Exar's test capabilities are given in page 9).



## WHAT PACKAGE TYPES ARE AVAILABLE?

All semi-custom IC's are available in dual-in-line (DIP) packages. Commercial grade units are normally packaged in plastic DIP packages. Exar offers a wide selection of such packages, in 8-, 14-, 16-, 18-, 20-, 24-, 28- and 40-pin versions. The industrial on military grade products requiring hermetic packaging are available in frit-seal ceramic (CERDIP) packages. All of the packaged units are subjected to Exar's stringent quality assurance specifications prior to shipment (see pages 36 and 37).

## IS THERE A SECOND-SOURCE FOR SEMI-CUSTOM IC'S?

In most high-volume production applications of IC's, the customer often requires more than one supplier of a given IC. Anticipating this "alternate-source" requirement, Exar has made contractual agreements with other IC manufacturers to provide a second-source for many of Exar's semi-custom IC's. In addition, Exar's XR-A100, XR-B100, XR-C100A, XR-D100, XR-F100 and the XR-G100 family of bipolar Master Chips are direct replacements for the "Monochip A, B, C, D, F and G" products manufactured by Interdesign, Inc. of Sunnyvale, California.

In certain cases, where a critical supply situation may exist, Exar can also provide a special "bonded inventory" of parts, either in chip form or in packaged form, with prior arrangement with the customer.

## WHAT IF MY PRODUCTION REQUIREMENTS EXCEED MY INITIAL EXPECTATIONS?

It is not unusual for an end-product using the semi-custom IC to be extremely successful in a very short time. In that case, the anticipated volume of the custom IC may jump from few thousand units to several hundred thousand units. When that happens, Exar can quickly convert your semi-custom design to a full custom chip and make it much more cost-effective for you. Translating a semi-custom design to a full custom IC is a very simple trouble-free step, which can be normally done in *less than six months* (see page 7) and at a modest cost.

## CAN EXAR SUPPLY CHIPS?

All of Exar's semi-custom products can also be supplied in chip form, for hybrid assemblies. Page 37 gives a detailed description of the electrical specifications, visual inspection criteria and the handling of shipping options available for monolithic chips.

## CAN EXAR DO ENVIRONMENTAL SCREENING?

Exar has complete burn-in, environmental test and screening services available for temperature-stressing, thermal-shock or humidity and hermeticity tests. For a detailed analysis of your needs consult Exar's Marketing Department.

### FLOW CHART OF TYPICAL SEMI-CUSTOM DEVELOPMENT

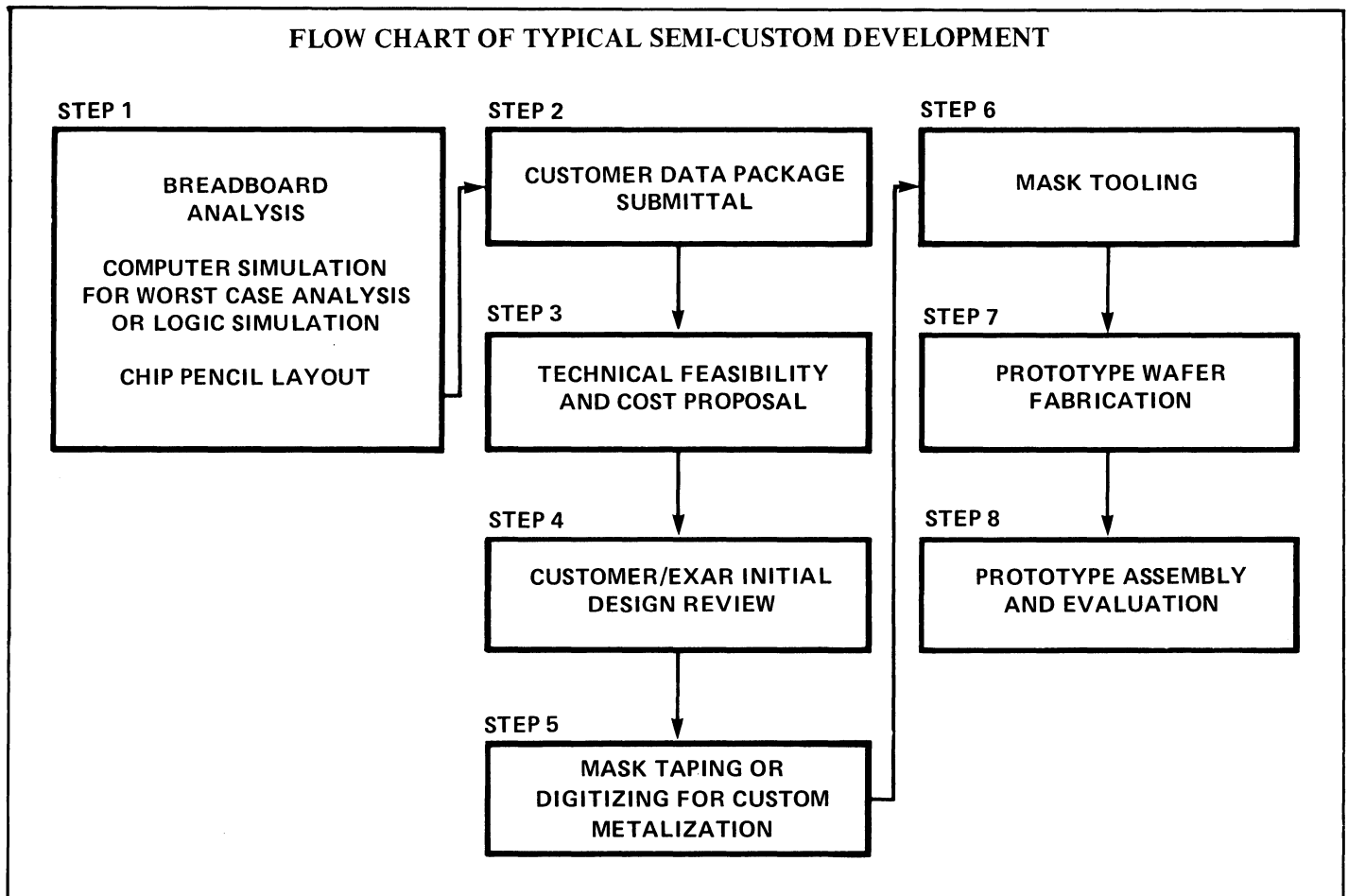

# Economics of Semi-Custom Design

In developing either linear or digital custom circuits, one is always confronted with the following key question: for a given product type and production requirement, is it cheaper to develop a semi-custom or a full custom IC? Since the functional requirements of each custom IC program vary greatly, there is no general answer to the above question. However, based on Exar's long experience in both full and semi-custom IC design, and depending on the overall production requirements, it is possible to establish some sound economic guidelines for choosing the most cost-effective approach.

## COST FACTORS INVOLVED

Any custom IC development, whether full or semi-custom, involves similar types of cost factors. These are:

1. Non-recurring engineering (NRE) or development costs.
2. Cost or unit price of the product in production quantities.

In the case of monolithic IC's, particularly for those which have relatively limited production volume, the development costs may be a significant factor in the cost of the end product. Therefore, when discussing the economics of custom IC's for medium to low production quantities, it is best to consider the cost trade-offs in terms of the "amortized unit price" of the IC at a given production volume. This amortized unit price is defined as the actual cost of each unit *including* its share of the development cost. As an example, a full custom IC may cost \$50,000 to develop, and may be priced at \$2.90 each at a 50,000 piece total production level. Then, its true amortized unit price including development costs will be \$2.90 plus \$1.00, or \$3.90. Similarly, an equivalent semi-custom IC may cost \$5,000 to develop and be priced at \$3.20 each, at the same 50,000 production level. Then, its amortized per unit

price will be \$3.30, or approximately 20% cheaper than a full custom.

The figure below gives a comparative graph of the amortized unit price for a typical full custom design along with its equivalent in semi-custom form, for various production quantities. For comparison purposes, the relative "ratio" of the amortized unit price is plotted along the vertical axis. If this ratio is greater than 1.0, then the semi-custom method is the more cost-effective solution.

## NO TWO IC'S ARE THE SAME

By definition, each custom IC type is unique: it has a special performance, interface or test requirement. Therefore, the cost comparison curve given below is shown as a "spread" rather than a single line. This is because, in addition to the production quantity, the cost of monolithic IC's also depends on the circuit complexity (i.e., yield), special test requirements and the IC package type.

The key information contained in the relative cost vs. quantity figure can be summarized as follows:

1. For total production requirements of 50,000 pieces or less, the semi-custom approach is definitely the most economical.
2. For production requirements of 200,000 pieces or more, the full custom design is more cost effective.
3. For production quantity requirements in the 50,000 to 200,000 pieces, the crossover point for the most economical approach depends strongly on the specifics of a particular IC function i.e., its special test, environmental screening and package requirements.

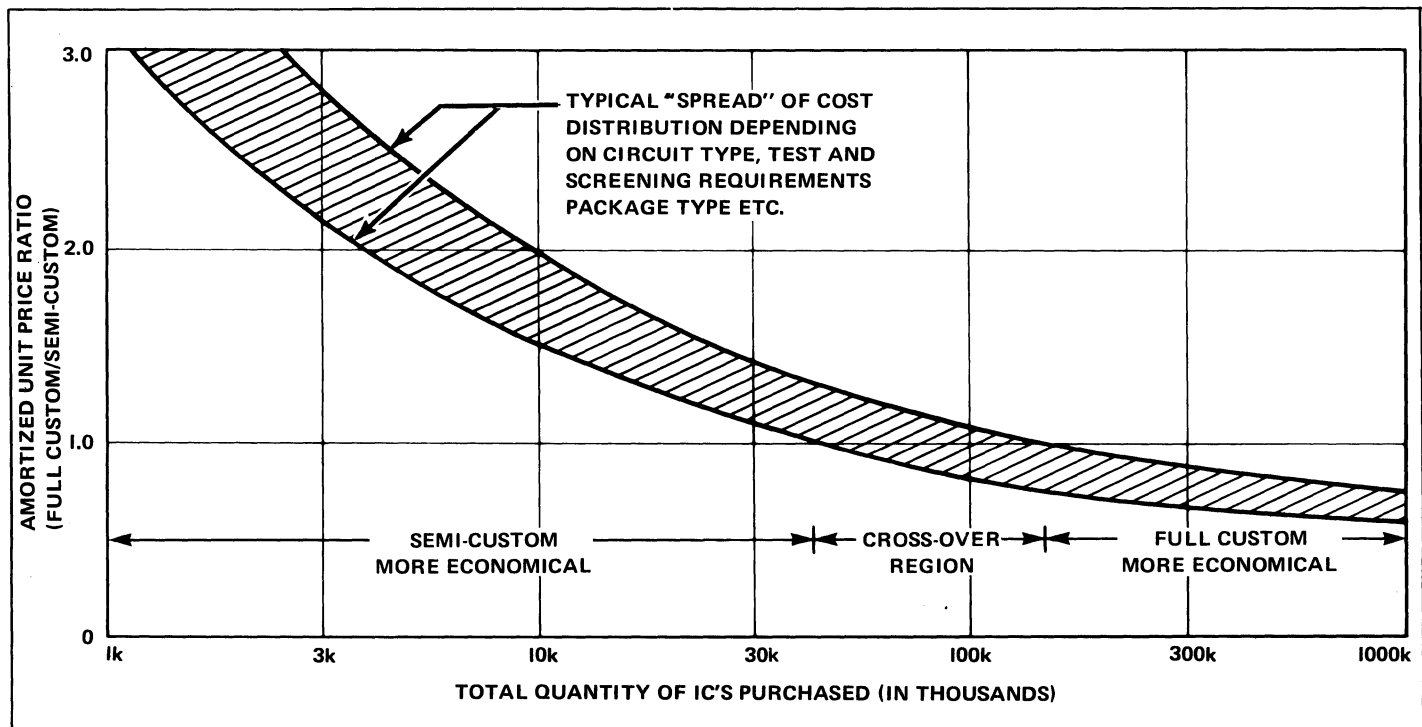

Typical Cost vs. Quantity Comparison of Full Custom and Semi-Custom Designs



# Converting Semi-Custom to Full Custom

Exar is the only company that can offer you the advantages of semi-custom and full custom bipolar design programs because of our in-house complete semiconductor manufacturing capability. This unique capability gives us the ability to start a custom development program using a combination of our semi-custom Master Chips during the initial or early phases of a customer's product, taking full advantage of the low tooling cost and short development cycle. As a customer's product matures and its market expands, resulting in higher volume production run rates, Exar can convert the multiple semi-custom chip approach into a single custom IC, achieving a cost reduction and in many cases a performance improvement. The significant advantage of this type of program is that the risk associated with a custom development is greatly reduced; the IC design approach has been proven, production "bugs" are out of your product and your production line continues to flow during the full custom chip development. Once the custom chip is completely characterized and found acceptable, the semi-custom IC system in your product can be phased-out while the full custom IC is being phased-in.

## SEMI- AND FULL CUSTOM COMBINATION —THE TWO-STEP DEVELOPMENT—

In many custom development programs one is faced with very short development times, and a rapid transfer into high volume production. Such a requirement does not leave room for lengthy development and design change or iteration cycles associated with conventional full custom IC design.

Exar's unusual capability of combining both full and semi-custom design capabilities and a complete wafer fabrication capability under one roof provides a unique solution to this problem: by initially developing the prototypes in a semi-custom form, and then converting them to full custom. In this manner, the customer has the "best of two worlds" in utilizing the combination of these two technologies: the

quick turn-around advantages of semi-custom Master Chips provide prototypes and the initial production units; the subsequent full custom design provides cost savings at high volume production. Yet, during this transition, the customer is assured of a continuous flow of product through its production line.

In such a *Two-Step* development, the semi-custom prototypes often serve as a "monolithic breadboard" to optimize and de-bug the final design. The performance of the semi-custom chip accurately simulates the characteristics of the final, full custom design. Yet, it allows one to perform design iterations or changes in a very efficient and cost-effective form. In fact, the only difference between the semi-custom and the full custom chip is the actual "size" of the silicon chip.

Once the design is satisfactory, conversion of a semi-custom to a full custom chip is very straight forward and relatively risk free: we simply remove the unused electrical components from the chip to reduce the chip size and pass the resulting cost savings to you in the form of reduced unit price.

The *Two-Step* development capability, i.e., start as semi-custom and finish as full custom, is a very powerful design technique. It avoids the risks associated with a conventional "black box" type custom design where one doesn't know, until the very last day of development, whether the circuit works or if it is manufacturable.

Since it avoids costly design iteration or modification cycles, the *Two-Step* program does *not* take any longer or cost more than the conventional full custom development; yet it gives one a very high degree of assurance that the final full custom unit will "work the first time".

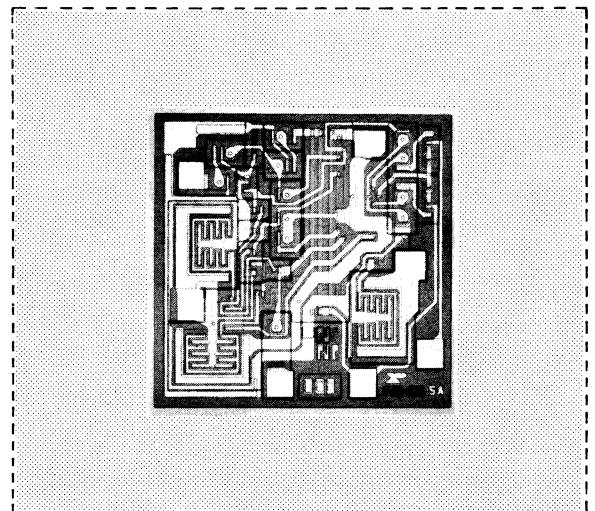
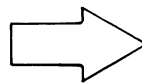
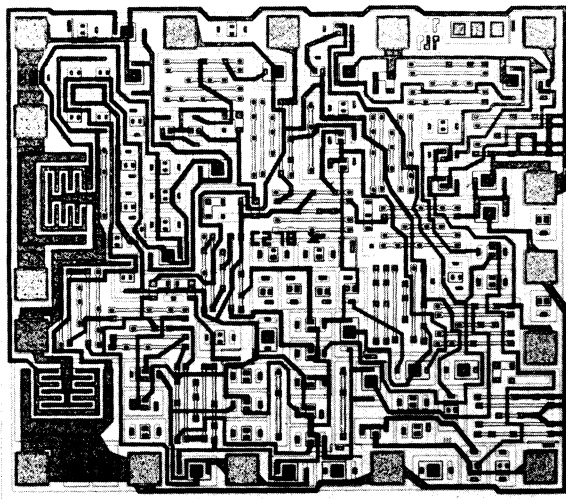

Semi-Custom Design and Its Full Custom Equivalent

# Full Custom Development

Exar offers a complete design and production capability for full-custom IC development using Exar's bipolar and I<sup>2</sup>L technologies. This provides an excellent complement to Exar's unique semi-custom capability.

Exar's full-custom IC development and production capabilities offer complete flexibility to meet changing customer needs or design problems. We can develop a complete custom IC starting from your "black-box" specifications or reduce your working breadboard prototype to a monolithic chip. Alternately, if you have the facilities and resources to do the IC design and the layout, Exar will provide you with the device characteristics and IC layout rules for the particular process suitable to your design and review your IC layout for you. Then, Exar can generate the IC tooling and fabricate your IC prototypes for you.

## YOUR FIRST STEP FOR FULL CUSTOM DESIGN

The following technical data package is required in order for Exar to provide you with a firm quotation for your full-custom development program:

1. Circuit block diagram with sub-blocks.
2. Circuit Schematic or Logic Diagram.
3. Description of circuit operation and pertinent application information.
4. Preliminary or objective device specification indicating min/max conditions and limits for the critical parameters (i.e., input/output voltage and current levels, operating frequency, timing diagrams, input/output impedances, power dissipation, etc.)
5. Production requirements and the desired development time table.

## IC FABRICATION FROM CUSTOMER'S TOOLING

Exar has a complete in-house silicon wafer fabrication and processing line at its main manufacturing plant, in Sunnyvale, California. This facility is geared to handle 3-inch silicon bipolar or I<sup>2</sup>L wafers, and is available for manufacturing custom IC's directly from a set of customer supplied IC tooling, in coordination with Exar's mask design department.

If you have a set of IC tooling (i.e., masks and composite overlays) or are contemplating having one designed for you, Exar's technical staff will be glad to review it for you to assure compatibility with Exar's technology and layout tolerances. Our wafer processing technology and capabilities are compatible with the industry standards, and with the technologies of other leading bipolar IC manufacturers.

For additional information on Exar's wafer fabrication services, contact Exar directly. We pride ourselves in our flexibility and quick response to your needs.

## FLOW-CHART OF TYPICAL FULL CUSTOM DEVELOPMENT PROGRAM

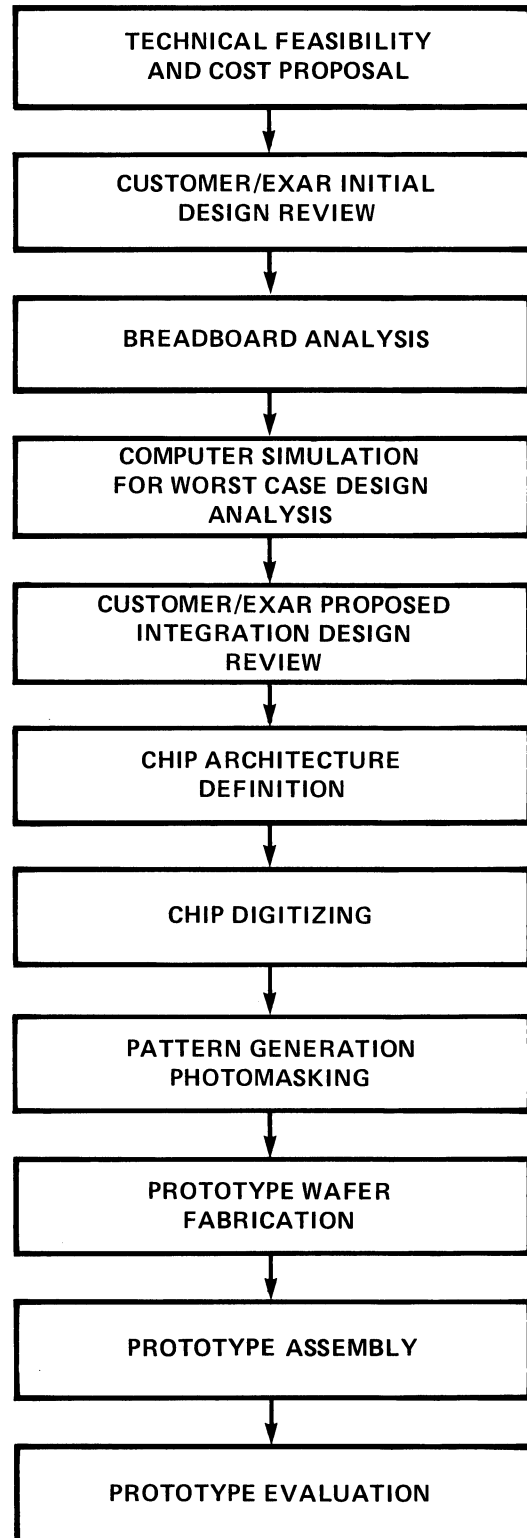



# Testing of Semi-Custom IC's

All production units of semi-custom IC's are 100% electrically tested and screened, to mutually agreed test specifications, using one of Exar's several computerized test systems. In addition, Exar's Quality Assurance Department performs an independent set of electrical tests on randomly selected samples of production units, prior to shipment, to assure conformity with Exar's Acceptable Quality Level (AQL) standards.

## EXAR'S TEST CAPABILITIES

Exar can perform two basic types of tests for production IC's: (1) parametric testing which measures a specific parameter value (normally current or voltage) and compares it against pre-established limits; (2) functional testing which applies a series of operating conditions and compares the circuit under test with a known good device. These two types of tests can be performed both as steady state (DC) or dynamic (AC) measurements. Although DC tests are easily implemented by automated testers, AC tests are usually difficult and expensive to perform in production.

Exar has a complete computer-controlled IC test facility, to provide 100% electrical testing of IC chips either in wafer form, using automated wafer-probe stations, or in dual-in-line package form, using automatic handlers. Exar's test facility has four independent computer controlled test systems.

### ● Fairchild 5000C Tester

This is a fully automatic test system which can perform both functional and parametric DC tests, with an accuracy of 0.1%, at a rate of approximately 10 milliseconds per test. It can be used for AC tests, with additional interface circuits. It can handle four separate test stations simultaneously.

### ● Fairchild Sentry 200 Tester

This is an automated high-speed test system primarily intended for complex digital circuits. It can perform both DC and functional tests on logic or memory systems up to 48-pins. It

operates four separate test stations from a central computer.

### ● Teradyne J273 Tester

This is a fully automated test system for AC and DC testing of linear circuits. It is designed for high-volume production testing, and operates four separate test stations simultaneously.

### ● Logical/Servant-8 Tester

This is a computer-controlled tester especially designed for testing of digital semi-custom chips. It performs functional tests on complex logic arrays, up to 40-pin complexity.

Testing is one of the most critical steps in IC production. Therefore, to insure efficient and cost-effective testing of production IC's, it is essential that a preliminary *test plan* be prepared, jointly between customer and Exar, at an early stage of the prototype development effort. This preliminary test plan then leads to the final detailed test specifications, once the development prototypes are fully evaluated and characterized, and the circuit is ready to release to production.

## TEST INTERFACE DEVELOPMENT

Before releasing a semi-custom IC into production, it is necessary to develop a complete test interface (i.e., the necessary test program software and the interface hardware or fixtures) which will allow the monolithic chip to be 100% tested using Exar's computer-controlled testers. This development effort normally requires *four to six* weeks to complete. However, it can be initiated in parallel with the IC development if a test plan is completed and a production commitment is made at the start of the program. There is normally a non-recurring engineering charge associated with this test interface development. This charge varies depending on the device specifications, test complexities and the follow-on production requirements.



Fairchild 5000C Test System

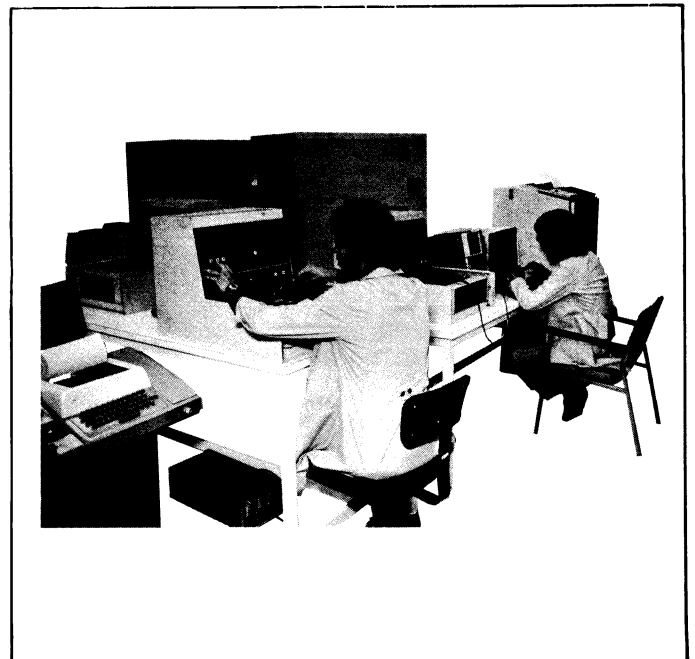

Fairchild Sentry 200 Test System

# Linear Semi-Custom Design

The linear semi-custom design program is based on Exar's family of bipolar Master Chips. As described earlier, these Master Chips are fabricated through all the necessary device fabrication steps, except for the final step of "metal interconnection". They are then "customized" to form a monolithic IC simply by the application of a "custom" interconnection pattern.

Exar currently has seven different bipolar Master Chips in production, with additional chips in development for future applications. Four of the Master Chips, the XR-A100, XR-B100, XR-C100A, XR-F100 and XR-G100, are all fabricated with the same manufacturing process and have a maximum operating voltage of 20 volts. The XR-D100 and XR-X100, are designed for 36V and 75V maximum operating voltages, respectively. A brief outline of the key features of these seven bipolar Master Chips is given below and in Table form for comparison purposes, on the bottom of Page 11.

- **MASTER CHIP XR-A100**

This chip is rated for a maximum operating voltage of 20 volts. The die is 73x83 mils and contains 260 passive and active components, including two high current (200 ma) NPN transistors for such applications as audio output stages, relay drivers, high current voltage regulators, or 4-20 ma control loops for controlling large valves and actuators. Also, included on the chip are 58 small signal NPN transistors, 18 small signal PNP transistors, 15 Schottky diodes for high speed applications, four 30 k $\Omega$  and four 100 k $\Omega$  pinch resistors, and diffused resistors ranging from 200 $\Omega$  to 3.6 k $\Omega$  for a total diffused resistance of 214 k $\Omega$ . It can accommodate up to 16 pins, and is a direct replacement for Monochip A. A detailed description of the XR-A100 appears on Page 12.

- **MASTER CHIP XR-B100**

This chip is rated for a maximum operating voltage of 20 volts. The die is 85x85 mils and contains 300 passive and active components, including 69 small signal NPN transistors, 12 small signal PNP transistors, 16 Schottky diodes for high speed applications, six 30 k $\Omega$  and six 100 k $\Omega$  pinch resistors and diffused resistors ranging from 200 $\Omega$  to 3.6 k $\Omega$  for a total diffused resistance of 265 k $\Omega$ . Although there are no high current NPN transistors on this chip, one can be constructed by paralleling several of the small signal NPN's. This chip is particularly well suited to complex linear circuitry or a combination of linear and digital circuits. The XR-B100 can accommodate up to 24 pins and is a direct replacement for Monochip B. A detailed description of the XR-B100 appears on Page 13.

- **MASTER CHIP XR-C100A**

This chip is rated for a maximum operating voltage of 20V. The die is 56x62 mils and contains 110 passive and active components, including 23 small signal NPN transistors, 8 PNP transistors, 6 Schottky diodes for high speed applications, two 30 k $\Omega$  pinched resistors and diffused resistors ranging from 200 $\Omega$  to 3.6 k $\Omega$  for a total diffused resistance of 154 k $\Omega$ . The XR-C100A is especially well suited for simple circuitry that is required in large volume. The small size of this chip allows a large number of them to be processed at once on a wafer, thus, reducing fabrication costs. The XR-C100A can accom-

modate up to 14 pins and is a direct replacement for Monochip C. A detailed description of the XR-C100A appears on Page 14.

- **MASTER CHIP XR-D100**

This is a high voltage Master Chip designed for 36 volt maximum operating voltage. The die is 80x81 mils and contains 209 active and passive components, including 50 small signal NPN transistors, 16 dual PNP transistors, two 60 k $\Omega$  pinched resistors and diffused resistors ranging from 200 $\Omega$  to 3.6 k $\Omega$  for a total diffused resistance of 180 k $\Omega$ . Although there are no high current NPN transistors, one can be constructed by paralleling several of the small signal NPN's. The XR-D100 is suited for all kinds of applications in which a higher maximum operating voltage is required. The XR-D100 can accommodate up to 16 pins and is a direct replacement for the Monochip D. A detailed description of the XR-D100 appears on Page 15.

- **MASTER CHIP XR-F100**

This is the largest Master Chip and has a maximum operating voltage of 20V. The die is 98x115 mils and contains 472 components, including four 200 ma high current NPN transistors, 93 small signal NPN transistors, 36 dual PNP transistors, nine 30 k $\Omega$  pinched resistors and diffused resistors ranging from 200 $\Omega$  to 3.6 k $\Omega$  for a total diffused resistance of 425 k $\Omega$ . The XR-F100 is designed to accommodate the more complex and demanding analog, or analog and digital, functions. The high current NPN transistors are well suited for high current voltage regulator outputs, relay drivers, audio or transducer outputs and 4-20 ma control loops for controlling large valves and actuators. The XR-F100 can accommodate up to 24 pins and is a direct replacement for the Monochip F. A detailed description of the XR-F100 appears on Page 16.

- **MASTER CHIP XR-G100**

This chip is rated for a maximum operating voltage of 20 volts. The die is 90x90 mils and contains 309 active and passive components, including 2 high current NPN transistors, 58 small signal NPN transistors, 18 small signal PNP transistors, eight 60 k $\Omega$  pinch resistors and diffused resistors ranging from 200 $\Omega$  to 3.6 k $\Omega$  for a total diffused resistance of 269 k $\Omega$ . The XR-G100 is ideal for applications that require more pins or components than are possible with the XR-A100. The XR-G100 can accommodate up to 18 pins and is a direct replacement for the Monochip G. A detailed description of the XR-G100 appears on Page 17.

- **MASTER CHIP XR-X100**

The XR-X100 Master Chip is especially designed for applications requiring very high supply voltages. It is fabricated with a special manufacturing process which provides transistor breakdown voltages in excess of 75 volts. The XR-X100 is a 115x95 mil chip and contains 4 high current NPN transistors, 30 small signal NPN transistors, 16 dual collector PNP transistors, three 30 $\Omega$  pinched resistors, three 30k Epi FET's and diffused resistors ranging from 500 $\Omega$  to 5 k $\Omega$  for a total diffused resistance of 235 k $\Omega$ . The XR-X100 can accommodate up to 18 pins.

Designing integrated circuits for voltage levels in excess of 50



volts requires special design and layout considerations. For this reason, the specific details of the XR-X100 chip are not listed in this brochure. If you have an application requiring the very high voltage capabilities of the XR-X100 Master Chip, please contact Exar's Applications Engineering department for consultation and a feasibility review of your design.

## COMPONENT UTILIZATION

The total number of components on the Exar Master Chips range from 110 on the XR-C100A to 472 on the XR-F100. However, the number of these components that are actually useable depends upon many considerations. The first things that must be evaluated are the general requirements of the finished circuit. Factors such as the number of pins that are required, breakdown voltage as well as die size limitation imposed by packaging requirements, determine which of the Master Chips are suitable. This can impose limitations on the number of available components.

Circuit characteristics also impose limitations upon the number of usable components. For example: a circuit whose package pin configuration can be chosen freely, that handles small signals, low supply voltages, is insensitive to d-c offset voltages, and whose various circuit blocks follow one another with a minimum of interconnection between blocks, may be able to use over 90% of the components on the selected Master Chip.

On the other hand, in more complex designs requiring special layout or design considerations, the component utilization may be as low as 50%. Examples of such cases are those where the package pin-outs are predetermined, or the choice of component locations on the die may be fixed due to thermal consideration, circuitry-symmetry or offset requirements. In certain cases the series or parallel connection of several resistors to obtain a predetermined value, or paralleling several transistors to increase their current handling capability, may also limit the total component utilization.

Over 300 semi-custom programs have been completed to date using Exar's bipolar Master Chips. Thus, Exar's Engineering department has a great wealth of experience concerning the layout techniques utilizing the Master Chips. In many cases, it is advantageous for the customer to call Exar for a free consultation regarding the choice of a particular Master Chip which may be best suited for his application.

The bipolar Master Chips are laid out to provide easy routing of metal interconnection paths. In addition, a multiplicity of low resistance cross-unders are provided on the chip to simplify the interconnection layout. Based on our experience in the layout of various Master Chips, the table below gives a rough estimate of the ease of interconnection of a circuit on each of the Master Chips versus the number of components used in the circuit.

## EASE OF METAL INTERCONNECTION VS COMPONENTS USED

MASTER CHIP TYPE	EASY			SOMEWHAT DIFFICULT			DIFFICULT		
	NPN	PNP	RESISTANCE	NPN	PNP	RESISTANCE	NPN	PNP	RESISTANCE
XR-A100	40	12	120 k ohm	45	15	140 k ohm	48	16	160 k ohm
XR-B100	50	7	150 k ohm	52	9	170 k ohm	58	12	200 k ohm
XR-C100A	17	6	50 k ohm	18	7	60 k ohm	20	8	75 k ohm
XR-D100	38	20*	90 k ohm	41	24*	100 k ohm	45	26*	120 k ohm
XR-F100	60	40*	250 k ohm	70	46*	300 k ohm	80	54*	340 k ohm
XR-G100	50	7	150 k ohm	52	9	170 k ohm	58	12	200 k ohm

\*Dual-collector PNP's are counted as two singles.

## MASTER CHIP SELECTION GUIDE AND CROSS REFERENCE

MASTER CHIP TYPE	CHIP SIZE MILS	POSSIBLE PINS	MAXIMUM VOLTAGE	TOTAL COMPONENTS:	EQUIVALENT INTERDESIGN, INC. MONOCHIP
XR-A100	73 x 83	16	20V	260	Monochip A
XR-B100	85 x 85	24	20V	300	Monochip B
XR-C100A	56 x 62	14	20V	110	Monochip C
XR-D100	80 x 81	16	36V	209	Monochip D
XR-F100	98 x 115	24	20V	472	Monochip F
XR-G100	90 x 90	18	20V	309	Monochip G

# XR-A100 Master Chip

Chip Size: 73 x 83 mils

Bonding Pads: 16

Total Components: 260

Max. Operating Voltage:

NPN Transistors

20V

Small Signal: 58

Diffused Resistors

High Current: 2

200  $\Omega$ : 16

PNP Transistors: 18

450  $\Omega$ : 43

Schottky Diodes: 15

900  $\Omega$ : 43

Pinch Resistors

1.8 k $\Omega$ : 29

30 k $\Omega$ : 4

3.6 k $\Omega$ : 28

100 k $\Omega$ : 4

Total Resistance: 214 k $\Omega$

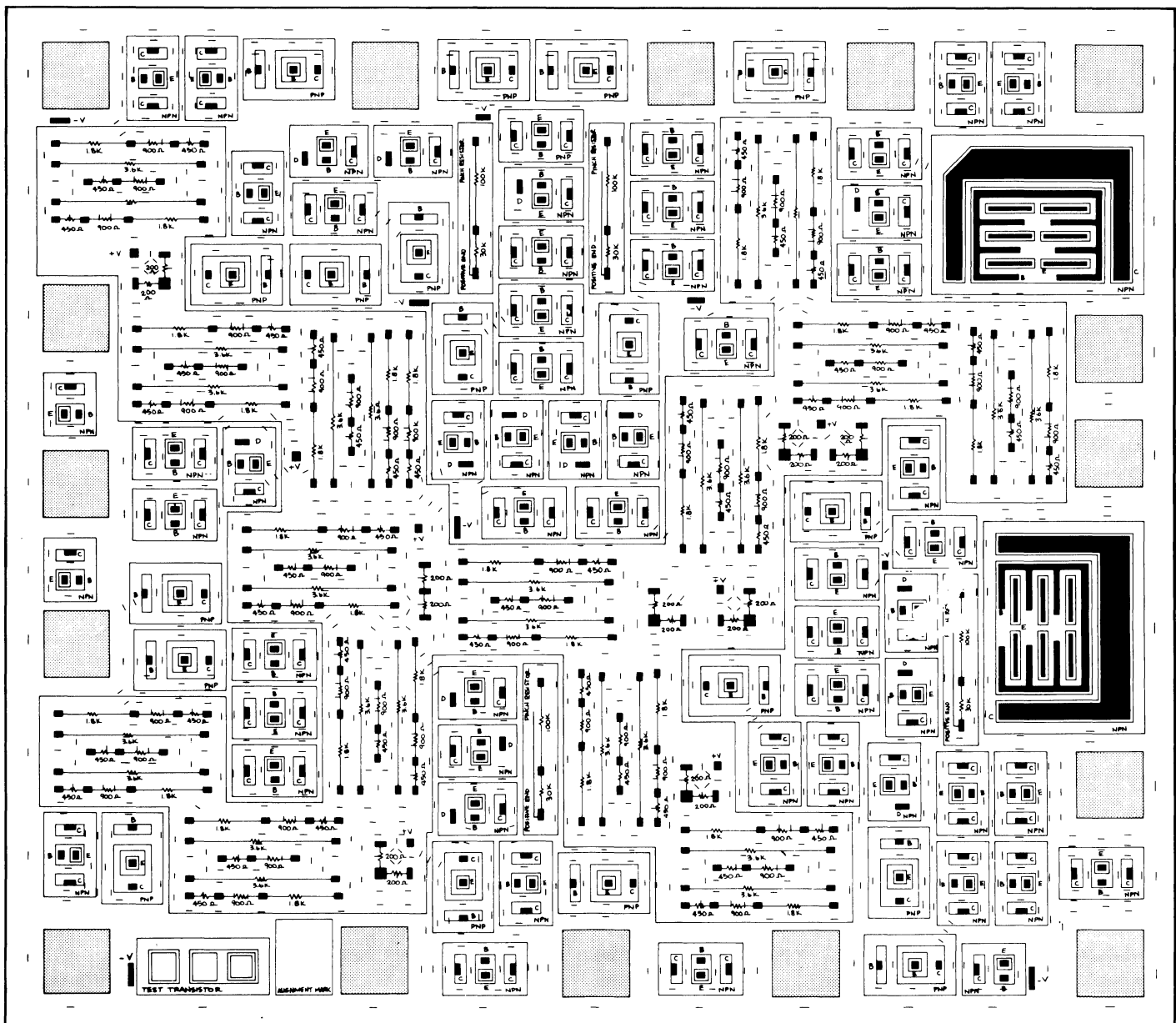
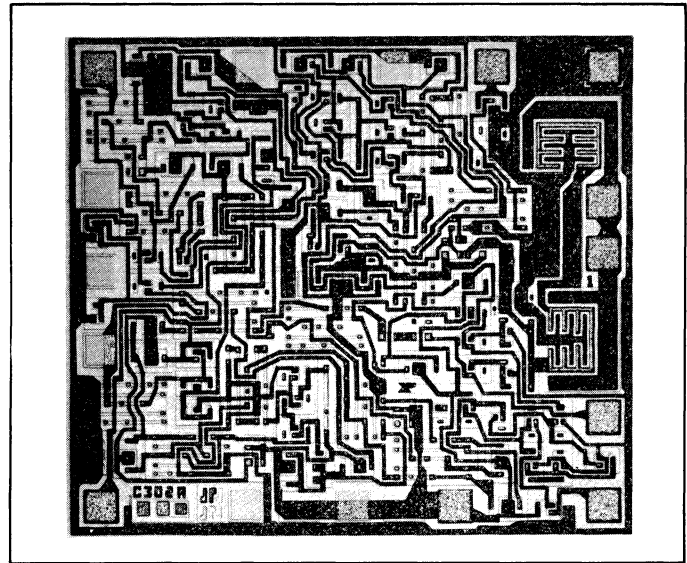

# XR-B100 Master Chip

Chip Size: 85 x 85 mils

Total Components: 300

NPN Transistors

Small Signal: 69

High Current: None

PNP Transistors: 12

Schottky Diodes: 16

Pinch Resistors

30 k $\Omega$ : 6

100 k $\Omega$ : 6

Bonding Pads: 24

Max. Operating Voltage:

20V

Diffused Resistors:

200  $\Omega$ : 27

450  $\Omega$ : 44

900  $\Omega$ : 45

1.8 k $\Omega$ : 39

3.6 k $\Omega$ : 36

Total Resistance: 265 k $\Omega$

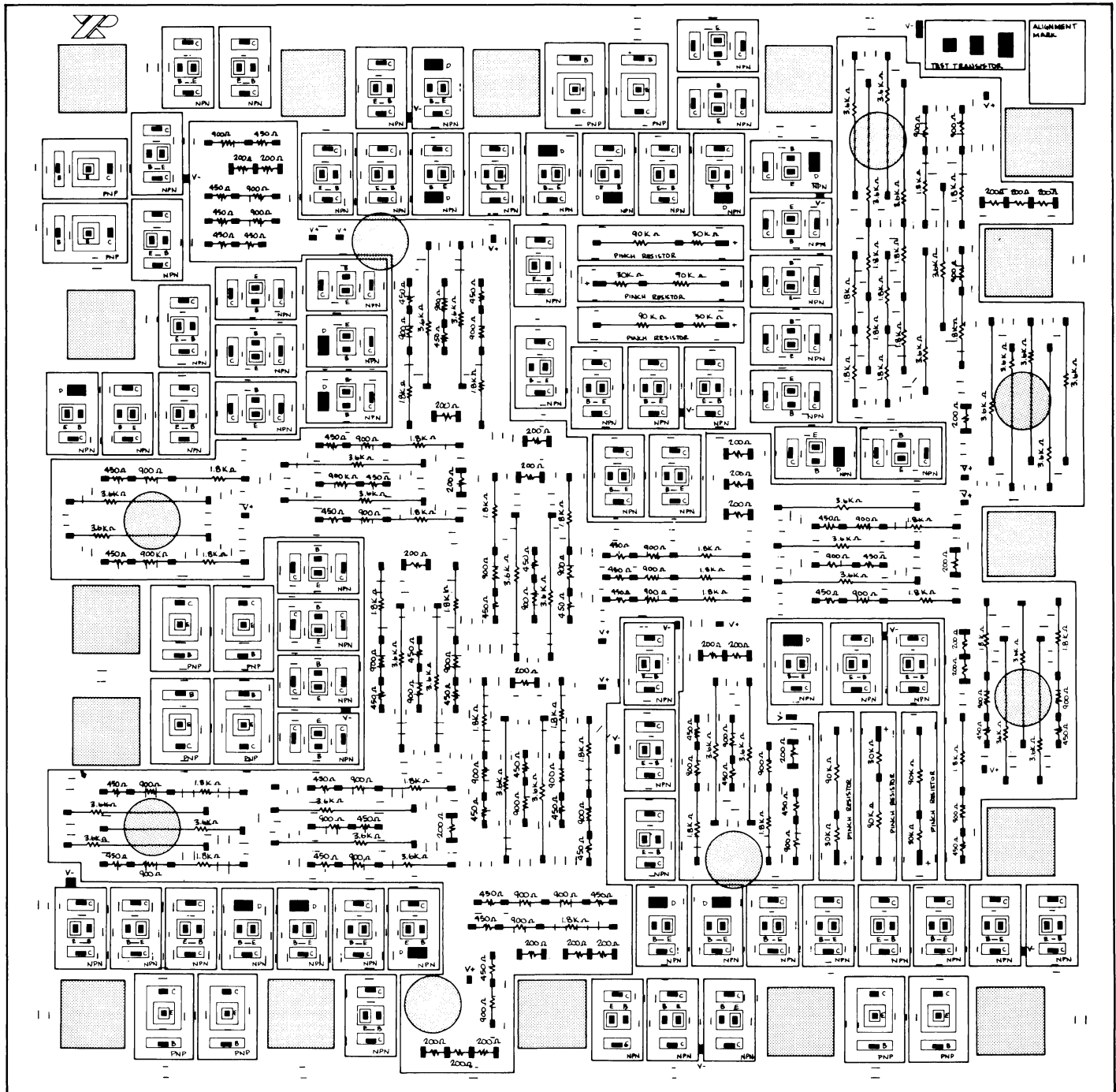
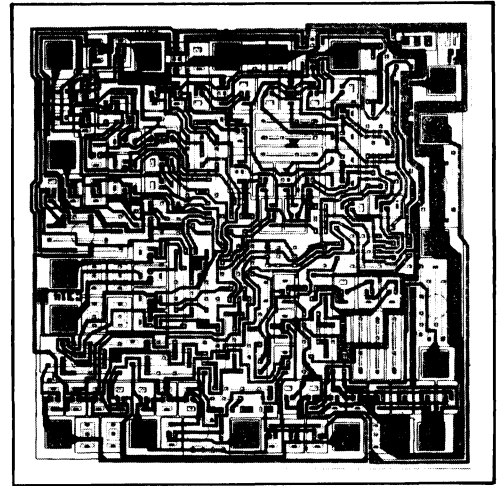

# XR-C100A Master Chip

Chip Size: 56 x 62

Bonding Pads: 14

Total Components: 110

Max. Operating Voltage:

NPN Transistors

20V

Small Signal: 23

Diffused Resistors:

High Current: None

200  $\Omega$ : 8

PNP Transistors: 8

450  $\Omega$ : 18

Schottky Diodes: 6

900  $\Omega$ : 20

Pinch Resistors

1.8 k $\Omega$ : 13

30 k $\Omega$ : 2

3.6 k $\Omega$ : 12

100 k $\Omega$ : None

Total Resistance: 154 k $\Omega$

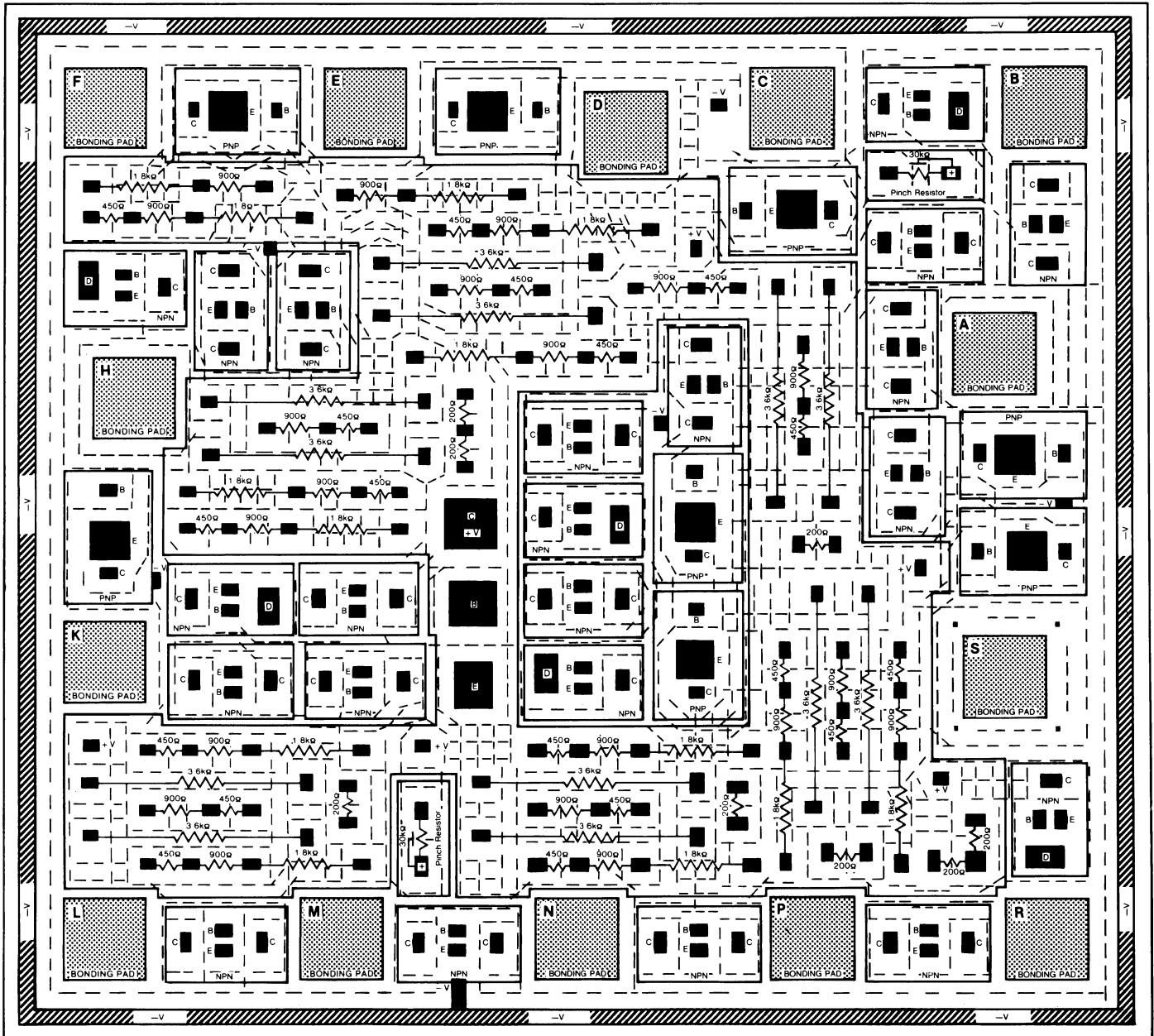





# XR-F100 Master Chip

Chip Size: 98 x 115 mils  
 Total Components: 472  
 Bonding Pads: 24  
 Maximum Operating Voltage:  
 20 V

NPN Transistors  
 Small Signal: 93  
 High Current: 4  
 Dual PNP Transistors: 36  
 Total Resistance: 425 k $\Omega$   
 Pinch Resistors: 9 30 k $\Omega$

Diffused Resistors  
 200  $\Omega$ : 18  
 450  $\Omega$ : 90  
 900  $\Omega$ : 68  
 1.8 k $\Omega$ : 61  
 3.6 k $\Omega$ : 61

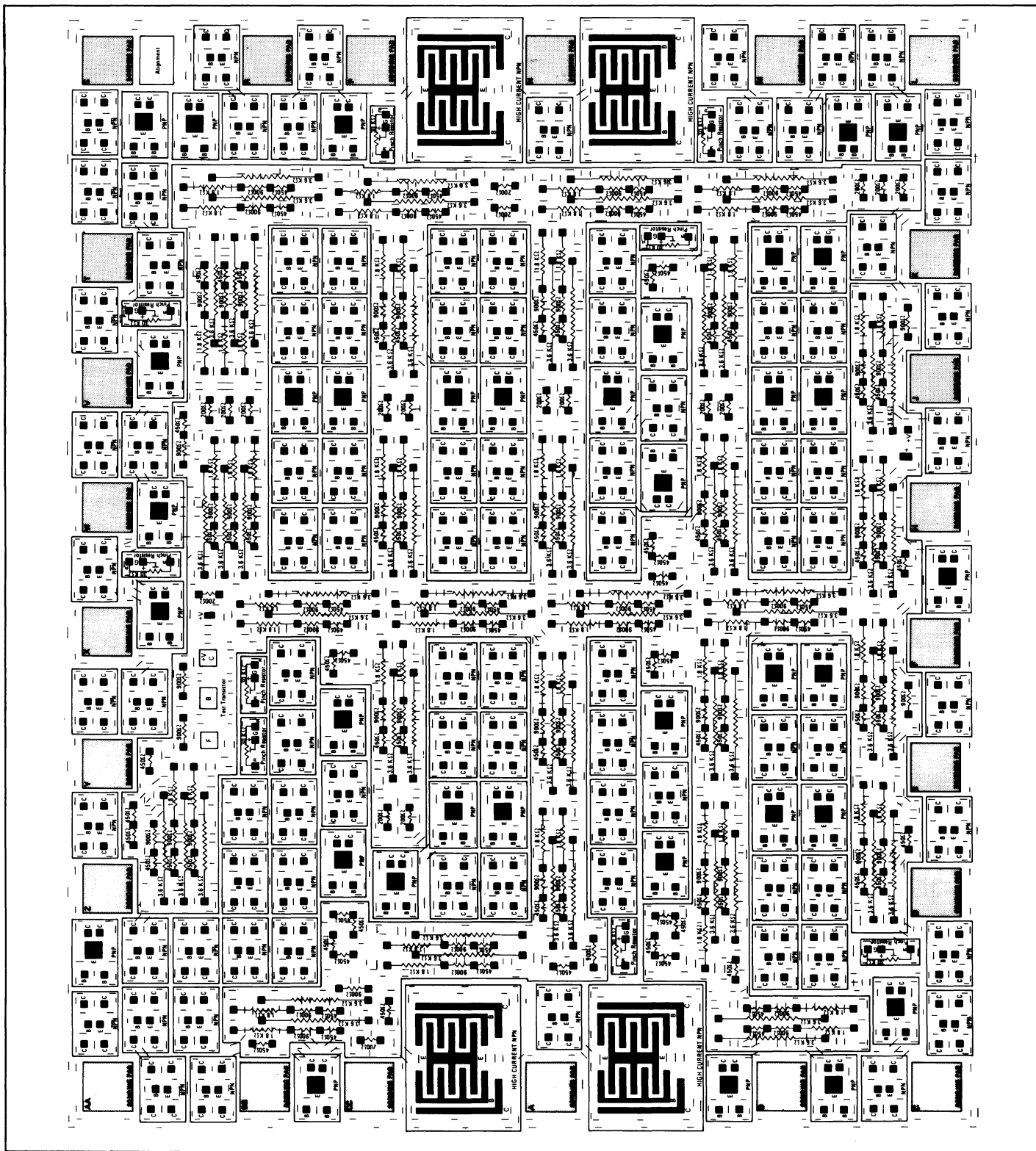

# XR-G100 Master Chip

Chip Size: 90 x 90 mils	Diffused Resistors
Total Components: 309	200 $\Omega$ : 19
NPN Transistors	450 $\Omega$ : 68
Small Signal: 58	900 $\Omega$ : 65
High Current: 2	1.8 k $\Omega$ : 44
PNP Transistors: 18	3.6 k $\Omega$ : 27
Schottky Diodes: None	Total Resistance: 269k
Pinch Resistors	Bonding Pads: 18
30 k $\Omega$ : None	Max. Operating Voltage: 20V
60 k $\Omega$ : 8	
100 k $\Omega$ : None	

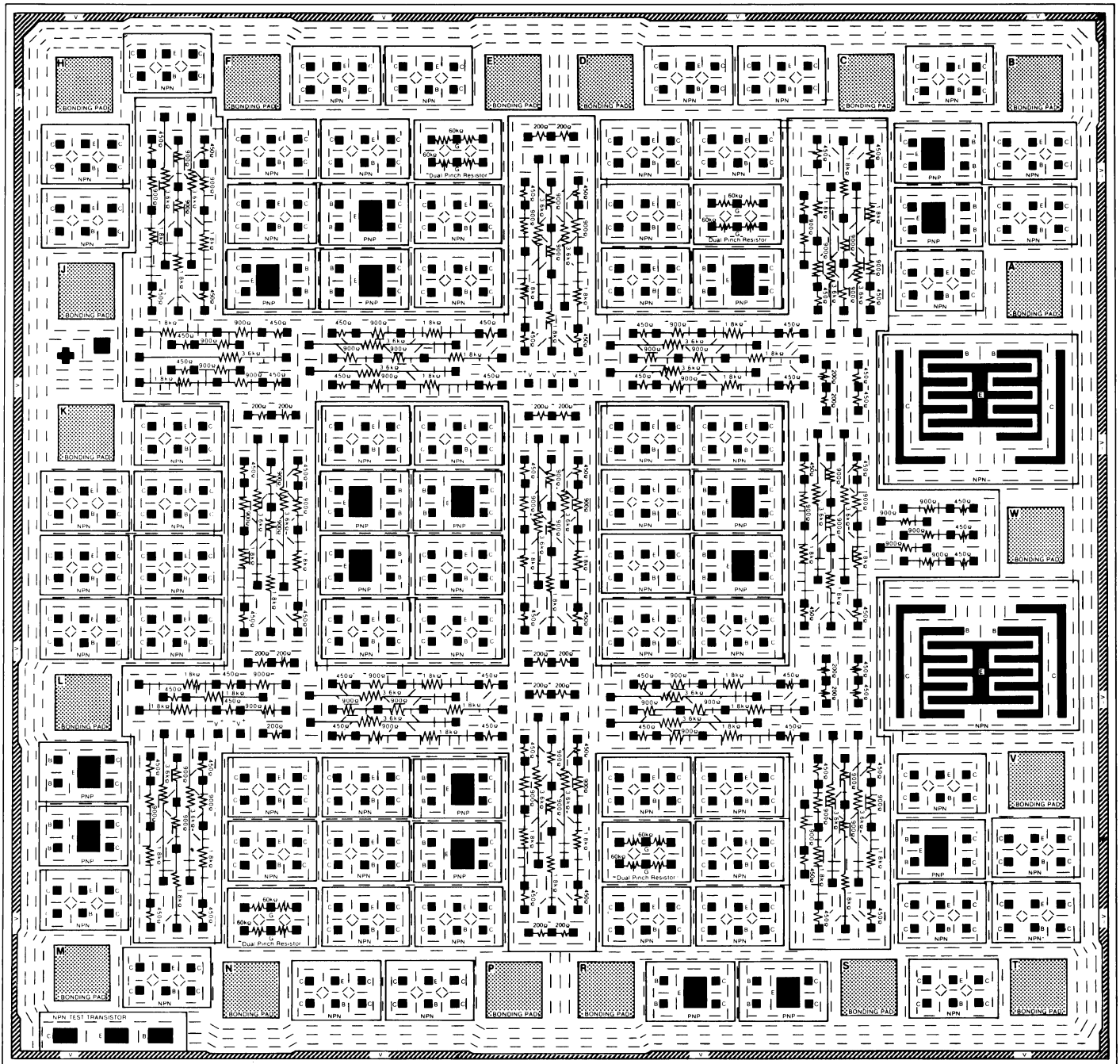

# Linear Semi-Custom Design Cycle

## —Six Simple Steps—

The basic linear semicustom design program involves only 6 *simple steps*, from the beginning of circuit design to completion of monolithic prototypes. The first three of these steps are done by the customer in consultation with Exar; the last three are performed by Exar:

### Step 1

Customer designs and breadboards his circuit using Linear Design Kit.

Customer purchases Exar's Linear IC Design Kit, made up of a comprehensive Design Manual and 34 monolithic kit parts or building blocks. Customer then breadboards his circuit and evaluates its performance using these kit parts. The electrical characteristics of kit parts are virtually identical to those which will be on the finished IC chip. Thus, this step provides a true breadboard simulation of final IC performance.

### Step 2

Customer does circuit layout.

After completion of breadboard evaluation, customer prepares a layout of the circuit on the selected Master Chip by following the basic layout rules given in the Design Manual. The layout is done simply by interconnecting appropriate device terminals with pen or pencil lines on oversize drawings of the Master Chips supplied with the kit. *NOTE: As an option, Exar also offers a layout service, at a nominal charge.*

### Step 3

Customer submits layout to Exar for review:

Exar reviews the circuit layout and schematic to check the following:

- a) That basic circuit function is feasible
- b) No layout rules are violated
- c) Circuit layout accurately represents the circuit schematic.

*NOTE: Steps 1, 2, and 3 are done at **no cost** to the customer, except for the nominal cost of the Linear Design Kit. Exar offers free consulting service and design advice during these first three steps. The "formal" part of the program is initiated at the completion of Step 3.*

### Step 4

Exar generates custom interconnection pattern.

Using Master Chip circuit layout supplied by the customer, Exar generates a custom interconnection pattern, or "metal mask" to be applied to pre-fabricated Master Chip wafers.

### Step 5

Exar fabricates customized IC wafers.

Exar applies the custom interconnection patterns to pre-fabricated Master Chip wafers. These wafers are then tested for semiconductor device characteristics (such as resistor values, diode and transistor characteristics) using special "test-patterns" etched on the wafer. The wafers are then accepted as "qualified wafer" if these device parameters are within the specified limits (see Table of Electrical Characteristics listed on pages 20 and 21).

### Step 6

Exar assembles and delivers monolithic prototypes.

The customized IC wafers are scribed or cut into individual IC chips. After a visual inspection, a number of these custom IC chips are assembled in dual-in-line IC packages and delivered to the customer for electrical evaluation, to conclude the program.

In addition to the monolithic prototype IC's, the following technical information is also delivered to the customer:

- a) A printout of device characteristics measured in Step 5, using special "test-patterns" on the IC wafers.
- b) An enlarged photo-micrograph of the finished IC chip showing the custom interconnection pattern.

The above information verifies the quality of the IC devices and the accuracy of the custom interconnection patterns applied to the Master Chip wafer.

### CIRCUIT SCHEMATIC

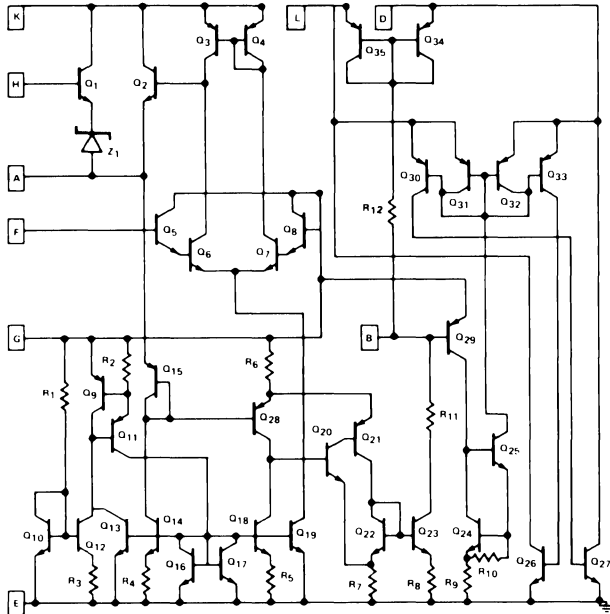

### PENCIL LAYOUT

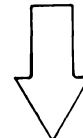
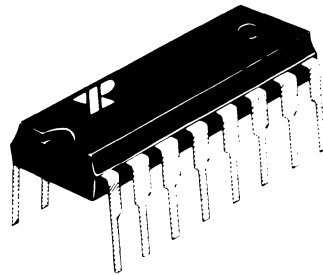
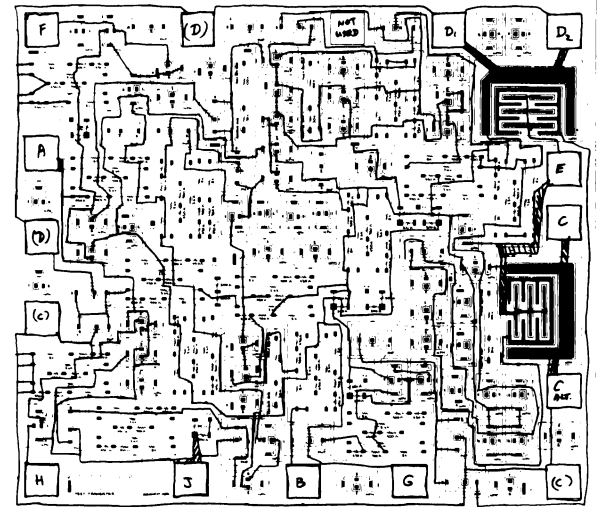

### FINISHED SEMI-CUSTOM CHIP

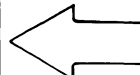
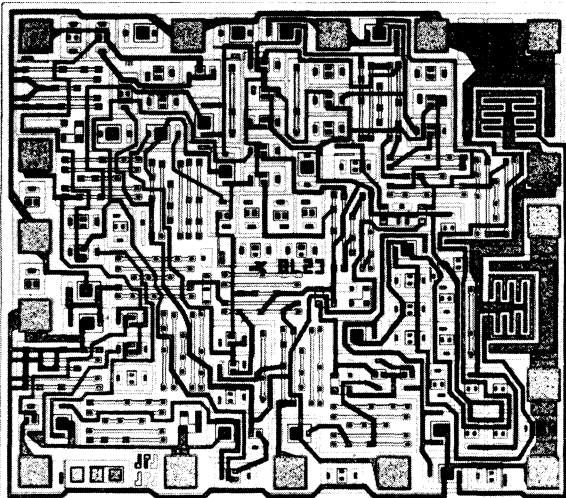

### MASK PREPARATION

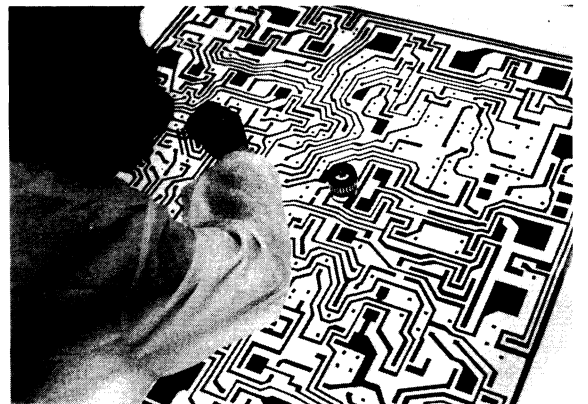



# Linear Design Kit

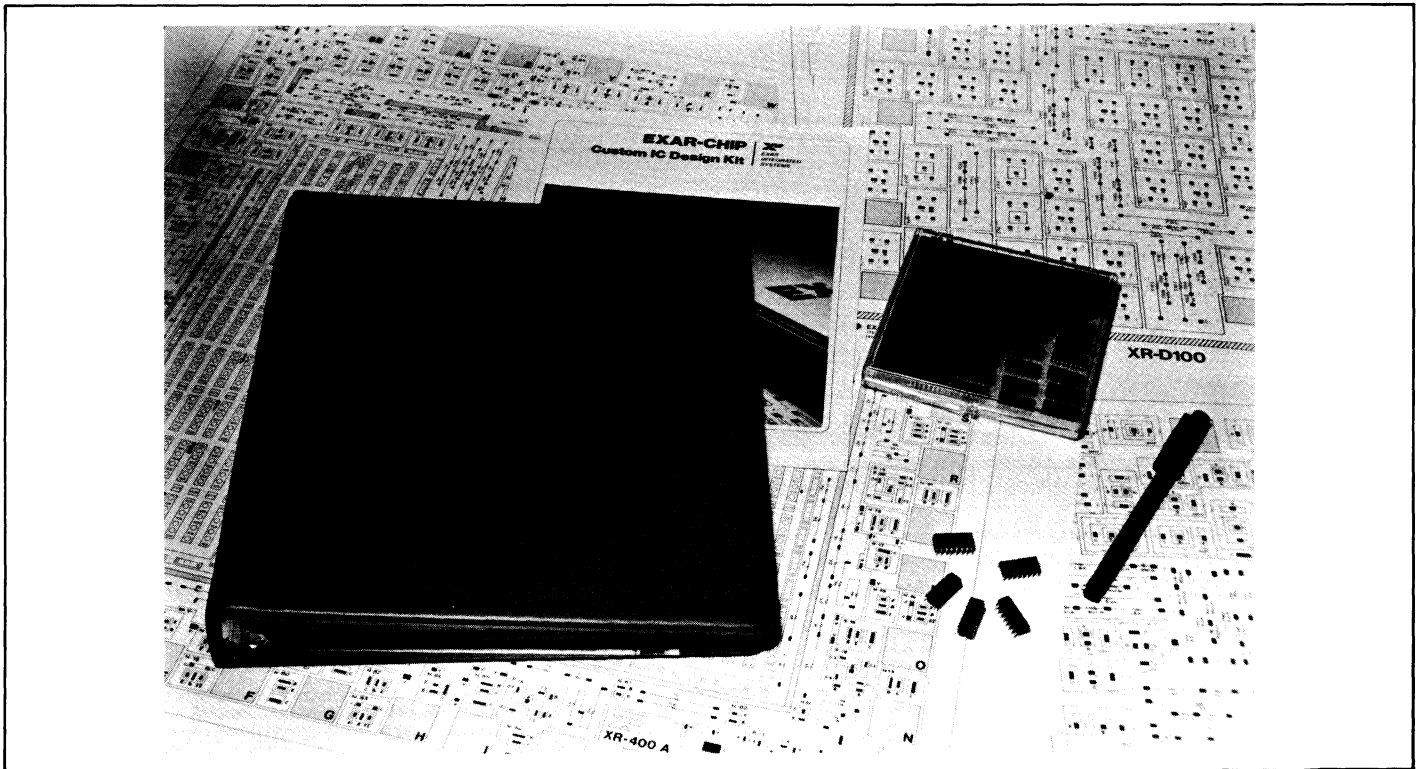

Exar's Linear Design Kit is comprised of thirty-four monolithic "kit parts" or breadboard components, a comprehensive Linear Design Manual, and a number of layout forms corresponding to Exar's Linear Master Chips. This Design Kit provides an ideal vehicle for the customer to do his own semi-custom IC design: he can evaluate his breadboard performance using the kit parts, and then proceed to do his own layout on the Master Chip work sheet.

The Linear Design Manual provided as a part of the Design Kit gives a detailed description of the basic guidelines and rules of IC design, evaluation, and layout. It also describes the electrical characteristics of each type of component available in the Master Chips, and gives some of the anticipated parameter distribution and "worst-case" tolerances associated with each. In addition, several design and layout examples are provided, to demonstrate the efficient use of the IC chips.

Once the breadboard evaluation is complete, the designer is ready to start his own IC layout using the appropriate Master Chip layout form supplied with the kit. When this layout is ready, and is reviewed by Exar, the formal part of the semi-custom development is ready to start.

## TECHNICAL ASSISTANCE

If any special or unusual circuit design or layout problems are encountered in the preparation of your semi-custom IC layout Exar's technical staff will be glad to review your design problem and provide technical guidance. In many cases, it is beneficial to call Exar for a preliminary discussion of your custom IC needs, even before you decide to buy a Design Kit.

## ADDITIONAL KIT PARTS

The amount of kit parts supplied as a part of the Linear Design Kit are sufficient for most designs. However, if additional kit parts are required to complete your evaluation, these can be obtained either directly from Exar, or through your local Exar technical representative.

## CONTENTS OF LINEAR DESIGN KIT

PART NO.	DESCRIPTION	NO. OF ARRAYS IN KIT	DEVICES PER ARRAY	APPLICABLE MASTER CHIP
XR-B101	Small Signal NPN Transistor Array (20 Volt Process)	8	5	All Except XR-D100
XR-D101	Small Signal NPN Transistor Array (36 Volt Process)	8	5	XR-D100 only
XR-B102	Lateral PNP Transistor Array (20 Volt Process)	4	5	All Except XR-D100
XR-D102	Dual Collector Lateral PNP Array (36 Volt Process)	4	4	XR-D100 and F100
XR-A103	Schottky-Clamped NPN's and High-Current NPN's	4	5	All Except XR-D100
XR-A104	Medium Value Diffused Resistor Array	4	9	All Master Chips
XR-A105	High and Low Value Resistor Array	2	9	All Master Chips
	Total Arrays	34		
	Linear Design Manual	1		All Master Chips

# Components in Linear Design Kit

## XR-B101 AND XR-D101 MONOLITHIC SMALL-SIGNAL NPN TRANSISTOR ARRAYS

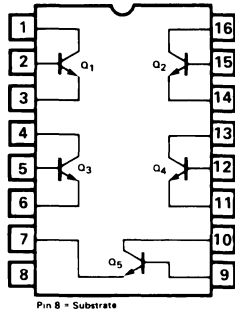

Each package contains five identical small signal NPN transistors. XR-B101 transistors correspond to NPN transistors available on XR-A100, XR-B100, XR-C100 and XR-F100 Master Chips. XR-D101 transistors are available only on XR-D100 chip.

## XR-A103 SPECIAL PURPOSE NPN TRANSISTORS

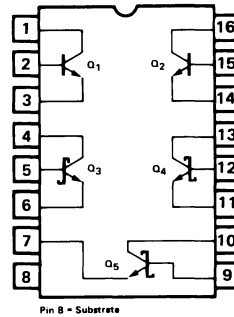

The XR-A103 contains two high-current (200 mA) NPN transistors ( $Q_1$  and  $Q_2$ ); and three Schottky-clamped small-signal NPN transistors ( $Q_3$ ,  $Q_4$  and  $Q_5$ ). The high-current transistors are available only on XR-A100, XR-C100 and XR-F100 chips. The Schottky-clamped transistors are available on XR-A100 and XR-B100.

## XR-B102 MONOLITHIC LATERAL PNP TRANSISTOR ARRAY

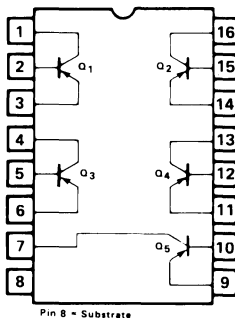

The XR-B102 chip contains five identical lateral PNP transistors. These are available on all chips except XR-D100.

## XR-A104 DIFFUSED RESISTOR ARRAY

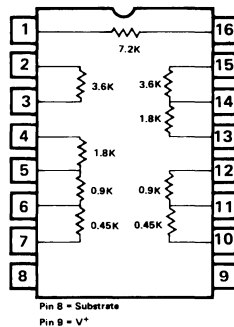

The XR-A104 chip contains an array of monolithic diffused resistors. Note that pins 8 and 9 of the package must be connected to the most negative and the positive voltages, respectively. The electrical characteristics of XR-A104 resistors are applicable to all bipolar Master Chips.

## XR-D102 MONOLITHIC DUAL-COLLECTOR PNP TRANSISTOR ARRAY

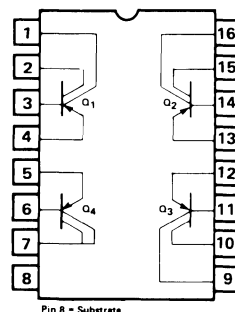

XR-D101 contains four dual-collector lateral PNP transistors, which are available on the XR-D100 and the XR-F100 Master Chips. The collectors of  $Q_1$ ,  $Q_2$  and  $Q_3$  are available separately; the two collectors of  $Q_4$  are shorted together internally.

## XR-A105 RESISTOR ARRAY

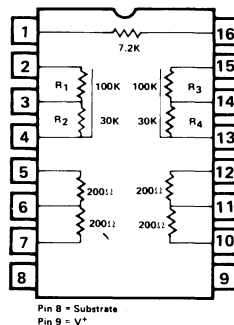

XR-A105 contains two sets of high-value "pinch-resistors" and two sets of low-value diffused resistors, and a 7.2 K $\Omega$  diffused resistor. Pins 4 and 13 indicate the positive terminals of the pinch-resistors. Pins 8 and 9 must be connected to the most negative and the positive voltages, respectively. The electrical characteristics of XR-A105 resistors are applicable to all bipolar Master Chips.

# Electrical Characteristics of Linear Master Chip Components

The following tables list the electrical characteristics of the circuit components available on Exar's linear Master Chips. Whenever applicable, the "worst case" tolerances and the parameter distributions are also listed. The parameter distributions are given in terms of the standard deviation or the "sigma-limit."

## 1. Small-Signal NPN Transistors

PARAMETERS	TYPICAL VALUES	$\sigma$ -LIMIT	WORST CASE TOLERANCE
Current gain (h <sub>FE</sub> ) @ 1 mA, 5V	180	—	80 – 300
Temperature Coefficient of h <sub>FE</sub>			
-55°C to 25°C	+0.5%/°C	—	—
25°C to 125°C	+1%/°C	—	—
Matching of h <sub>FE</sub>	—	3%	10%
Breakdown voltage (LV <sub>CEO</sub> )			
All Master Chips except D100	23V	—	20 – 30V
D100 Chip Only	40V	—	36 – 50V
Collector-Base Leakage Current @ 20V	1 nA	—	0.1 – 50 nA
Cutoff Frequency (f <sub>T</sub> ) @ 5 mA	500 MHz	—	—
Storage Time (t <sub>s</sub> )	50 nsec	—	—
Saturation Resistance (All except D100)			
One collector contact	100 Ohms	±50 Ohms	60 – 160 Ohms
Two collector contacts	50 Ohms	±20 Ohms	30 – 80 Ohms
Saturation Resistance (D100 chip)			
One collector contact	300 Ohms	±100 Ohms	150 – 480 Ohms
Two collector contacts	150 Ohms	±50 Ohms	75 – 240 Ohms

## 2. High-Current NPN Transistors (A100, F100 and G100 Master Chips Only)

PARAMETERS	TYPICAL VALUES	$\sigma$ -LIMIT	WORST CASE TOLERANCE
Current Gain (h <sub>FE</sub> )			
@ 1 mA, 5V	180	—	80 – 300
@ 100 mA, 5V	100	—	50 – 200
Temperature Coefficient of h <sub>FE</sub>			
-55°C to 25°C	+0.5%/°C	—	—
25°C to 125°C	+1%/°C	—	—
Matching h <sub>FE</sub>	—	3%	10%
Breakdown Voltage (LV <sub>CEO</sub> )	23V	—	20 – 35V
Collector-Base Leakage Current @ 20V	20 nA	—	1 – 500 nA
Cutoff Frequency (f <sub>T</sub> )	100 MHz	—	—
Storage Time (t <sub>s</sub> )	200 nsec	—	—
Saturation Resistance	5 Ohms	±1 Ohm	3 – 8 Ohms

## 3. Lateral PNP Transistors

PARAMETERS	TYPICAL VALUES	$\sigma$ -LIMIT	WORST CASE TOLERANCE
Current Gain (h <sub>FE</sub> ) @ 100 $\mu$ A, 5V	20	—	5 – 80
Temperature Coefficient of h <sub>FE</sub>	±0.1%/°C	—	—
Matching of h <sub>FE</sub>	—	5%	15%
Breakdown Voltage (LV <sub>CEO</sub> )			
All except XR-D100	35V	—	25 – 40V
XR-D100 Only	45V	—	36 – 60V
Collector-Base Leakage Current @ 20V	5 nA	—	0.1 to 100 nA
Cutoff Frequency (f <sub>T</sub> )	5 MHz	—	—
Storage Time (t <sub>s</sub> )	500 nsec	—	—
Saturation Resistance	600 Ohms	±100 Ohms	300 – 900 Ohms

4. Transistors Connected as Diodes (Collector and Base Shorted)

PARAMETERS	TYPICAL VALUES	$\sigma$ -LIMIT	WORST CASE TOLERANCE
<b>Small NPN</b>			
Forward Voltage Drop @ 1 mA, 25°C	0.74V	±200 mV	0.68 – 0.8V
Forward Voltage Matching	–	2 mV	6 mV
Forward Voltage Tracking	–	5 $\mu$ V/°C	15 $\mu$ V/°C
<b>Lateral PNP</b>			
Forward Voltage Drop @ 200 $\mu$ A, 25°C	0.70V	±200 mV	0.62 – 0.76V
Forward Voltage Matching	–	3 mV	6 mV
Forward Voltage Tracking	–	8 $\mu$ V/°C	25 $\mu$ V/°C

5. NPN Base-Emitter Junctions Used as Zener Diodes

PARAMETERS	TYPICAL VALUES	$\sigma$ -LIMIT	WORST CASE TOLERANCE
<b>Small NPN Transistors</b>			
Breakdown Voltage @ 100 $\mu$ A			
All Master Chips except D100	6.35V	±0.15V	5.9 – 6.8V
D100 Chip Only	6.7V	±0.2V	6.0 – 7.2V
Temperature Coefficient	+2.5 mV/°C	±0.3 mV/°C	1.8 – 3.1 mV/°C

6. Schottky-Barrier Diodes (A100/B100/C100 Only)

PARAMETERS	TYPICAL VALUES	$\sigma$ -LIMIT	WORST CASE TOLERANCE
Forward Voltage Drop @ 10 $\mu$ A	0.36V	±0.02V	0.22 to 0.44V
Temperature Coefficient of Forward Voltage Drop	-1.5 mV/°C	±0.1 mV/°C	±0.3 mV/°C
Reverse Breakdown Voltage	30V	–	20 – 40V
Leakage Current @ 20V	200 nA	–	1 nA – 1 $\mu$ A

7. Diffused Resistors (All Master Chips)

PARAMETERS	TYPICAL VALUES	$\sigma$ -LIMIT	WORST CASE TOLERANCE
Absolute Values	–	±10%	±25%
Temperature Coefficients			
-55°C to -25°C	-650 ppm/°C	±100 ppm	–
-25°C to 0°C	+150 ppm/°C	± 40 ppm	–
0°C to 25°C	+680 ppm/°C	± 40 ppm	–
25°C to 75°C	+1040 ppm/°C	± 20 ppm	–
75°C to 125°C	+1400 ppm/°C	± 40 ppm	–
Matching Between Resistors			
Identical Values	–	±0.8%	±2.4%
Non-Identical Values			
200 – 450	–	±1.6%	±4.8%
200 – 900	–	±1.7%	±5.1%
200 – 1.8K	–	±1.9%	±5.7%
200 – 3.6K	–	±2.0%	±6.0%
450 – 900	–	±1.5%	±4.5%
450 – 1.8K	–	±1.7%	±5.1%
450 – 3.6K	–	±1.9%	±5.7%
900 – 1.8K	–	±1.5%	±4.5%
900 – 3.6K	–	±1.7%	±5.1%
1.8K – 3.6K	–	±1.5%	±4.5%

8. Pinch-Resistors

PARAMETERS	TYPICAL VALUES	$\sigma$ -LIMIT	WORST CASE TOLERANCE
Absolute Value Tolerance	±50%	–	+100% to -50%
Matching Between Identical Resistors	±20%	–	–
Breakdown Voltage	6.4V	–	–
Temp. Coefficient	+6,000 ppm/°C	–	8,000 ppm/°C

# Digital Semi-Custom Design

Integrated Injection Logic (I<sup>2</sup>L) technology extends the capabilities of semi-custom design to high complexity digital or combined analog/digital systems. Exar has made this possible by the development of a family of I<sup>2</sup>L Master Chips which combine a large number of I<sup>2</sup>L gates and Schottky-bipolar transistors on the same chip. Similar to its bipolar counterpart, Exar's I<sup>2</sup>L semi-custom program also utilizes partially fabricated silicon wafers which are then "customized" by the application of special mask patterns.

Exar's digital Master Chips utilize bipolar input/output (I/O) interface circuitry on the same chip, along with the high-density I<sup>2</sup>L logic arrays. Thus, outwardly the I<sup>2</sup>L semi-custom chip looks and performs exactly as a bipolar LSI chip, which can readily interface with TTL or MOS level signals. In other words, these gate-array Master Chips combine the high functional density advantages of I<sup>2</sup>L technology with the interface and load-drive capability of the bipolar circuitry on the same IC. This feature makes it very convenient to "retrofit" I<sup>2</sup>L LSI designs into existing MOS or TTL type logic systems.

## ACHIEVING HIGH COMPLEXITY

Traditionally, the application of semi-custom design technology to complex digital systems has been somewhat limited due to one key factor: to be economically feasible, a complex digital LSI circuit must achieve a high functional density on the chip (i.e., high-gate count per unit chip area). This requirement is not compatible with the random interconnection concept which is key to the semi-custom or Master Chip design technique. Exar's *new* approach to this age-old problem overcomes this limitation; and achieves packing densities approaching those of full custom digital LSI layout while still maintaining the low-cost and the quick turn-around attributes of semi-custom IC design. This is achieved by making use of unique layout and interconnection properties of I<sup>2</sup>L gates, and by extending the customizing steps to additional mask layers, besides the metal-interconnection pattern.

Exar's I<sup>2</sup>L Master Chips are customized by not one but *three* mask layers:

1. A custom diffusion pattern to define gate outputs and custom "underpasses" for interconnection.
2. A custom "contact" mask which opens contact windows or "activates" only those devices actually used in the design.
3. A custom metal interconnection mask which interconnects all the "activated" devices.

## FULLY-AUTOMATED MASK GENERATION

Exar has developed a unique, fully-automated mask-generation technique which allows all three custom mask layers used with I<sup>2</sup>L Master Chips to be generated simultaneously; directly from a customer's pencil layout on the Master Chip worksheet. This unique mask generation technique, and the *three-mask* customizing method are the heart of Exar's I<sup>2</sup>L semi-custom program. In this manner, one is able to combine low-cost quick turn-around capabilities of semi-custom designs with the high functional density of I<sup>2</sup>L technology, and make very efficient use of the chip area.

## WHEN TO USE DIGITAL SEMI-CUSTOM

The key application of I<sup>2</sup>L semi-custom design is to replace complex blocks of random-logic functions with a single monolithic chip. An entire digital sub-system comprised of many SSI or MSI chips, or discrete components can be put on a single I<sup>2</sup>L Master Chip, thus providing significant cost and space savings and greatly improving system reliability. The availability of bipolar input-output interface circuitry on the same chip along with the high-density I<sup>2</sup>L logic makes it very convenient to retrofit I<sup>2</sup>L designs into existing MOS or TTL logic systems. Therefore semi-custom I<sup>2</sup>L LSI designs provide cost-effective solutions for complex custom LSI requirements, even at production volumes as low as a few thousand pieces.

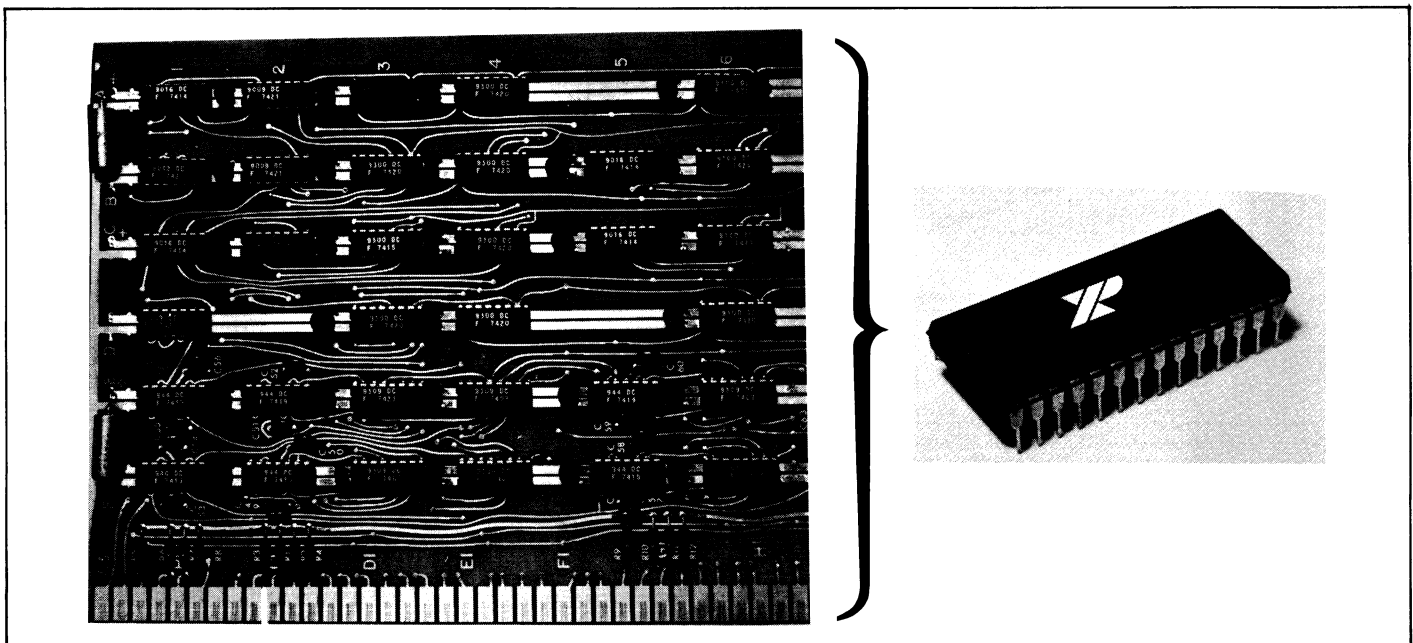



# Features of I<sup>2</sup>L Technology

Integrated Injection Logic (I<sup>2</sup>L) is one of the most significant recent advances in the area of monolithic LSI technology. Compared to other monolithic LSI technologies, I<sup>2</sup>L offers the following unique advantages.

**High Functional Density:** I<sup>2</sup>L logic gates offer much smaller size than their bipolar counterparts. Thus, a much higher degree of logic complexity or functional density can be achieved on a given IC chip.

**Easy to Interconnect:** Unique structure and geometry of I<sup>2</sup>L gates make them ideal for semi-custom design. An entire array of gates can be easily customized and interconnected with only three masks, without sacrificing high functional density.

**Bipolar Compatible Processing:** I<sup>2</sup>L is a direct derivative of conventional bipolar IC technology. Therefore, one can combine bipolar devices on the same chip as I<sup>2</sup>L gates. This feature has the following key advantages:

- Input-output sections of I<sup>2</sup>L chips can be made bipolar. Thus, they can readily interface with existing logic families or retrofit into existing systems.
- Analog and digital functions can be combined on the same chip. One of Exar's Master Chips, the XR-400, is specifically designed for such an application.

**Low-Voltage Operation:** I<sup>2</sup>L gates can operate with supply voltages as low as 1 volt, and require only a single power supply.

**Low-Current and Low-Power Operation:** Depending on speed requirements, I<sup>2</sup>L gates can operate with current levels in the nano-Ampere range. This feature, along with its low-voltage operation makes it ideal for applications in low-power, battery operated systems.

**Higher Reliability than MOS:** Since I<sup>2</sup>L gates have the same basic features of bipolar transistors, they are not subject to electrostatic burn-out problems associated with MOS transistors, and do not require special handling precautions.

**Wide Operating Temperature:** I<sup>2</sup>L gates are not as affected by leakage currents as their MOS counterparts. Thus, they can be made to operate over the full military temperature range.

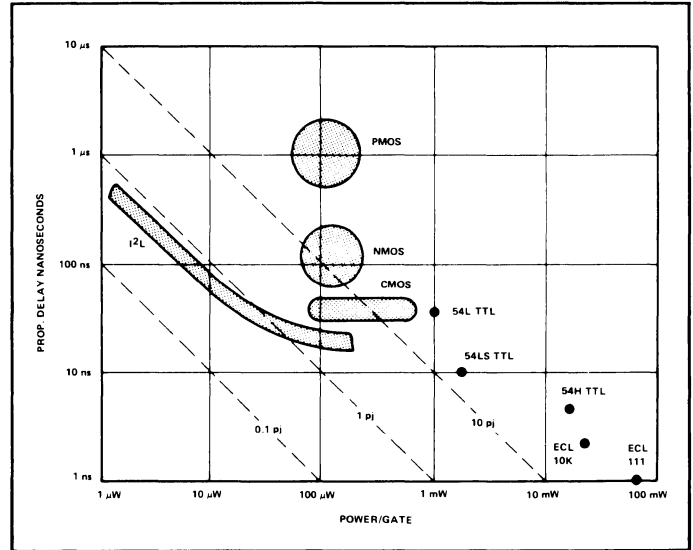

Comparison of Speed and Power Capabilities of Various Logic Families

## THE BASIC I<sup>2</sup>L GATE

The I<sup>2</sup>L logic technology is derived from the basic single-input, multiple-output inverter circuit shown below. The logic functions are performed in a manner similar to the case of conventional "open-collector" logic i.e., the outputs of various gates are interconnected together, in a wired-AND configuration. Most terminals of the I<sup>2</sup>L gate share the same semiconductor region (for example, the collector of the PNP is the same as the base of the NPN; and the emitter of the NPN is the same as the base of the PNP). This leads to a very compact device structure which occupies very small chip area. As a result, the functional density of I<sup>2</sup>L gates on a chip is comparable to that of MOS gates, and is approximately 5 times higher than conventional TTL logic.

## LOGIC CONVERSION TO I<sup>2</sup>L GATES

Converting conventional logic diagrams from their NAND/NOR gate equivalents to I<sup>2</sup>L gates is a simple and straight-forward procedure. This information is contained in I<sup>2</sup>L Design Manual, which is available as a part of Exar's I<sup>2</sup>L Design Kit. In addition, Exar has developed a large "Library" of I<sup>2</sup>L logic sub-blocks corresponding to popular logic functions, such as decoders, flip-flops and counters, which greatly simplifies this conversion process.

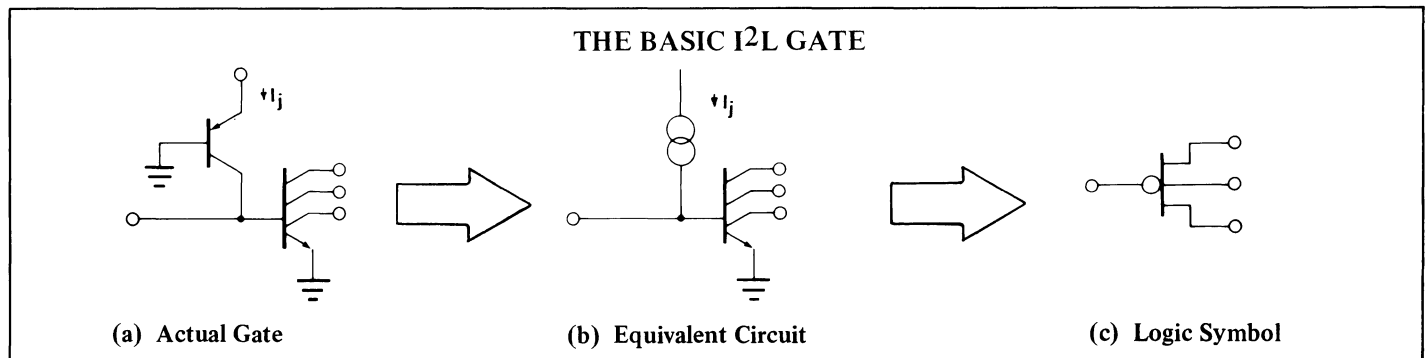

# Designing with I<sup>2</sup>L Master Chips

Exar currently has four I<sup>2</sup>L Master Chips in production, with additional chips in development for future applications. These are the XR-200, XR-300, XR-400 and the XR-500 Master Chips which combine bipolar transistors on the same chip with I<sup>2</sup>L gate arrays. The XR-200, XR-300 and the XR-500 are mainly designed for digital systems; the XR-400 Master Chip is intended for systems requiring both analog and digital functions.

All four of these Master Chips are fabricated with the same manufacturing process. They differ only in their architecture and the number of components. All of these chips are especially designed for Exar's unique *three-mask* customization process, using fully-automated mask generation techniques. Depending on the voltage breakdown requirements of the bipolar transistors, each of these chips are available with *two* options:

- **Option A: Maximum Operating Voltage of 6.0 volts.**
- **Option B: Maximum Operating Voltage of 12.0 volts.**

These options *only* effect the bipolar input/output interface sections of Master Chips, and have no effect on the performance characteristics of the I<sup>2</sup>L gates.

## XR-200, XR-300 and XR-500 MASTER CHIPS

These Master Chips are primarily designed for applications requiring only digital signal processing. They contain a large number of multiple-output I<sup>2</sup>L gates along with Schottky bipolar input/output buffers. Except for the difference in size, all three chips have the same architecture shown below. The I<sup>2</sup>L gates are arranged in array form at the center of the chip and the input/output buffers are located along the periphery of the chip. The bipolar I/O sections of the chips contain two identical sets of resistor arrays located at opposite ends of the chip, which are used for biasing the injectors of the I<sup>2</sup>L gates. The XR-200 contains 192 five-output I<sup>2</sup>L gates and 24 I/O buffers. The XR-300 contains 288 five-output I<sup>2</sup>L gates and 28 I/O buffers. The XR-500 contains 520 five-output I<sup>2</sup>L gates and 40 I/O buffers. A detailed description of the bipolar input/output interface circuitry is given on Page 28.

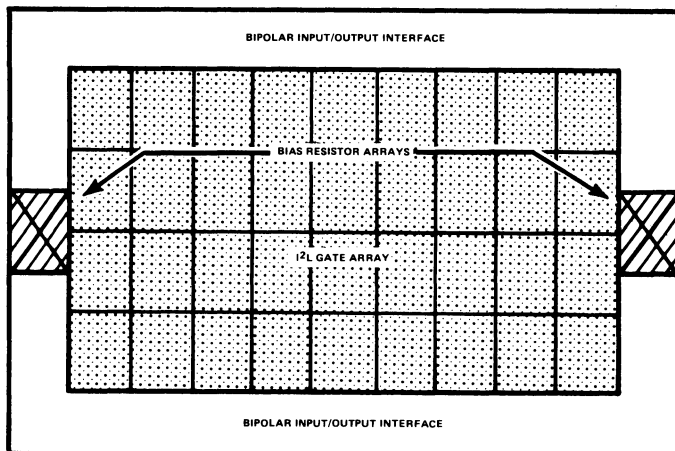

Basic Layout of XR-200, XR-300 and XR-500 Master Chips

## XR-400 MASTER CHIP

The XR-400 Master Chip is designed primarily for applications requiring the combination of analog and digital functions on the same chip. Thus, it is made up of both a linear and a digital section. The digital section of the chip has the same basic architecture as the XR-300: it contains 256 5-output I<sup>2</sup>L gates and 18 Schottky-bipolar I/O interface sections. The linear section of the chip is made up of an array of NPN and PNP transistors and resistors, and is very similar to Exar's bipolar Master Chips.

## COMPONENT UTILIZATION

The unique *three-mask* customizing technique used in Exar's I<sup>2</sup>L Master Chips makes them very efficient for both ease of logic layout and component utilization. One of the three customizing mask steps is a "custom diffusion" step which allows one to place low-resistance "cross-unders" or underpasses selectively on the chip. This technique provides the designer with virtually two layers of interconnection on the chip, and thus greatly simplifies the logic layout and improves the component utilization efficiency. Normally, in the case of random combinational logic, one can easily utilize 60% to 80% of the total gates available on a given I<sup>2</sup>L Master Chip. In the case of sequential and repetitive logic circuits, the gate utilization is normally as high as 80% to 100%.

In the case of the XR-400 Master Chip, which combines analog circuit components and the digital gates on the same chip, the *three-mask* customizing techniques is only applicable to the digital section. The analog section of the chip is customized with only the initial-interconnection pattern, similar to the case of linear Master Chips.

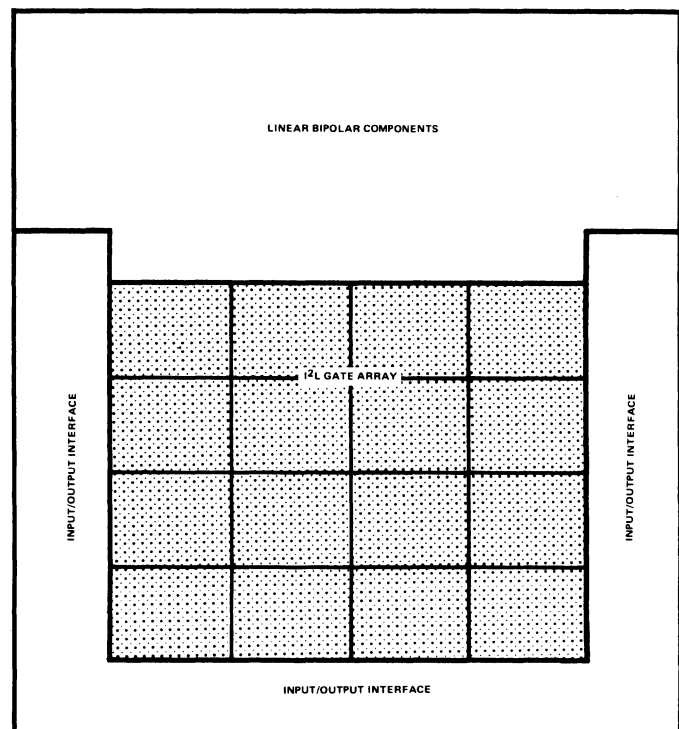

Basic Layout of XR-400 Master Chip

## THE I<sup>2</sup>L GATE ARRAY SECTION

This section of the I<sup>2</sup>L Master Chips is made up of logic "cells" which contain a number of multiple-output I<sup>2</sup>L inverters, grouped together. The figure below shows the typical layout of such a cell made up of eight multiple output inverters which share a common set of four injectors. The basic gate cells forming the I<sup>2</sup>L gate array are made up of P-type injectors and P-type gate *fingers* which serve as the base regions of the I<sup>2</sup>L gates. The six dots on each gate area indicate the possible locations or *sites* for gate input or outputs. The particular use of these sites as an input or an output is determined by two custom masks: an N-type collector diffusion mask which defines the locations of outputs, and a custom contact mask which opens the appropriate input and output contact. Finally, a third custom mask is applied to form the metal interconnections between the gates, and the gate cells. The custom N-type diffusion step, which determines the locations of gate outputs, is also used for forming low-resistivity underpasses between the gate-cells. The area between each of the gate cells can accommodate two or three parallel underpasses in the horizontal and the vertical direction, respectively. Since the N-type diffusion which forms these underpasses is a part of the customizing step, the location and the length of each underpass can be chosen to fit a given interconnection requirement. This method provides the designer with virtually all the advantages and capabilities of multi-layer interconnection paths on the surface of the chip; and allows approximately 80% of the gates on the chip to be utilized in a typical logic layout.

The custom logic interconnections can be easily laid out in pencil on a layout sheet by simply interconnecting the desired gate sites with a pencil line and appropriately defining the function of the site as an input, output, injector contact or an underpass. The function of each of the potential sites is defined by simply drawing an appropriate symbol on it, such as a circle for an "output" and a square for an "input," as defined in the example below.

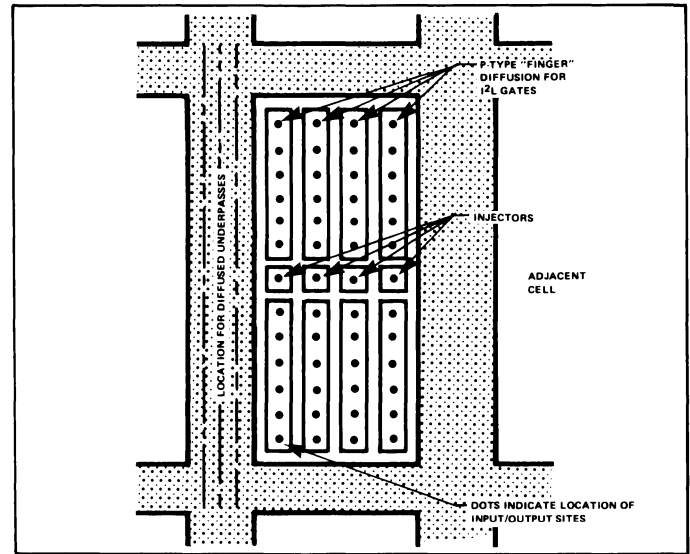

Basic 8-Gate Logic Cell Prior to Customization

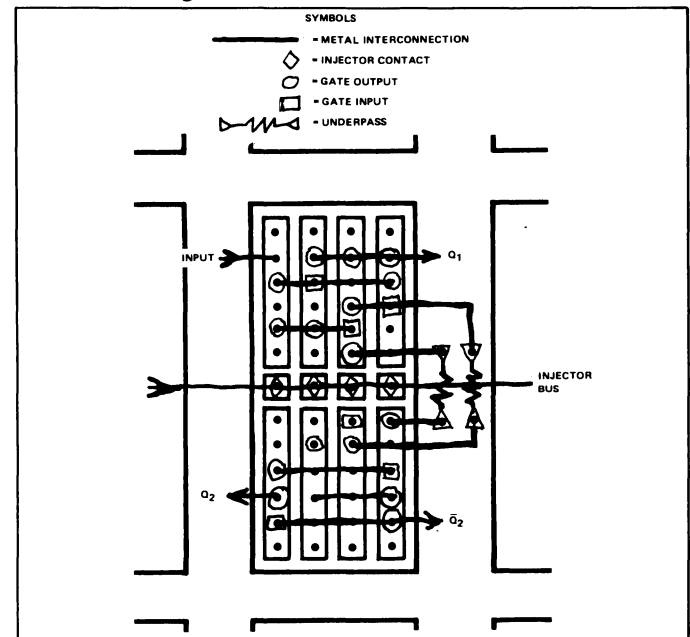

Sample Pencil Layout on Master Chip Worksheet

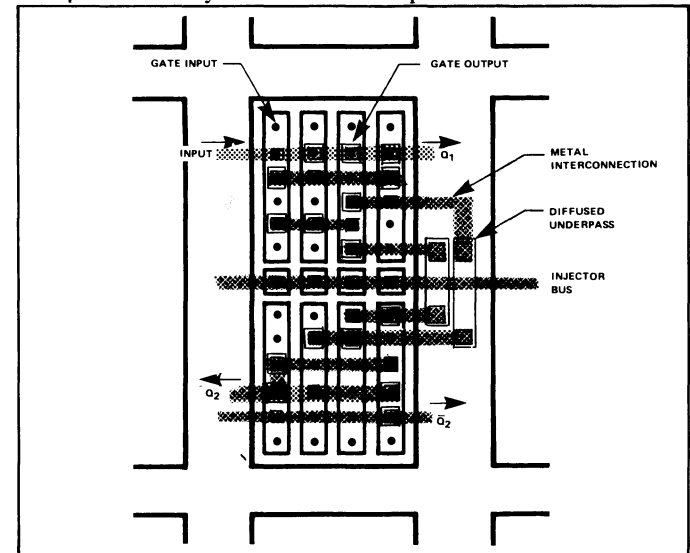

Sample Layout of 8-Gate Cell After Customizing it with N+ Collector Diffusion, Contact Mask and Metal Interconnection Pattern

## COMPONENTS AVAILABLE ON I<sup>2</sup>L MASTER CHIPS

CHARACTERISTIC	CHIP TYPE			
	XR-200	XR-300	XR-400	XR-500
I <sup>2</sup> L Gates	192	288	256	520
Schottky-Bipolar I/O Interfaces	24	28	18	40
Max. Operating Voltage				
A-Option	6V	6V	6V	6V
B-Option	12V	12V	12V	12V
Available Bonding Pads	30	34	40	42
Linear Components				
NPN Transistors	—	—	45	—
4-Collector PNP's	—	—	12	—
Diffused Resistors	—	—	336	—
Pinch Resistors	—	—	8	—
Chip Size (mils)	98 x 119	106 x 144	119 x 156	122 x 185

## BIPOLAR INPUT/OUTPUT INTERFACE SECTION

The bipolar input/output interface sections of the I<sup>2</sup>L Master Chips are located along the periphery of the chips. The component locations in a typical I/O cell are shown in the adjacent figure. Each I/O cell is designed to be either an "input" or an "output" interface, depending on the choice of the metal interconnection pattern applied to the cell. Furthermore, two adjacent cells can be combined together, to provide tri-state type output buffer. Some of the basic input and output circuit configurations available from the I/O interface are shown below. In the case of a tri-state output configuration, one would also utilize several gates from the I<sup>2</sup>L logic section, to perform the necessary gating functions.

Each input/output interface cell contains one bonding-pad, several resistors of varying values, a clamp-diode to substrate and two NPN transistors with optional Schottky-diode clamps. Each NPN transistor is capable of sinking 5mA of current with Schottky-diode clamps, and 10mA of current without Schottky-diode clamps, at a saturation voltage of  $\leq 0.5V$ . The breakdown-voltage of the bipolar I/O section is  $\geq 6V$  and  $\geq 12V$ , respectively, for "Option A" and "Option B" versions of the I<sup>2</sup>L Master Chips.

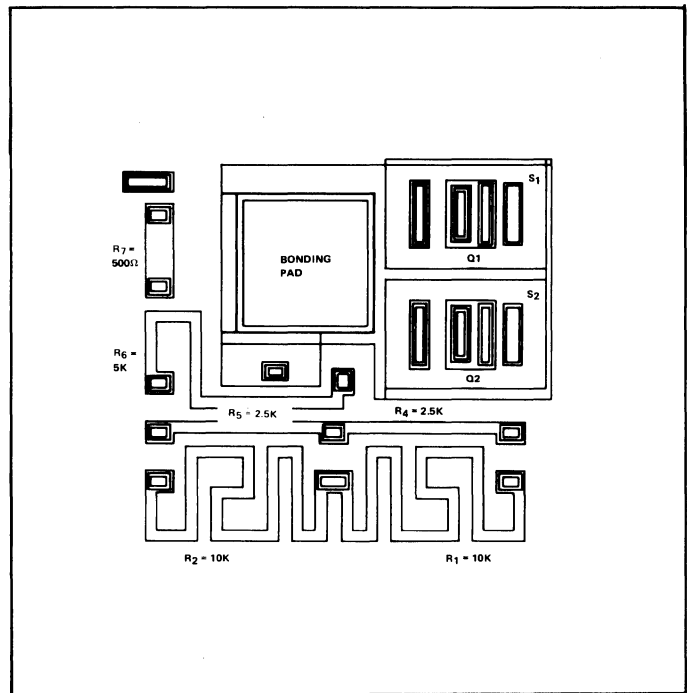

A Typical Schottky-Bipolar Input/Output Interface Cell

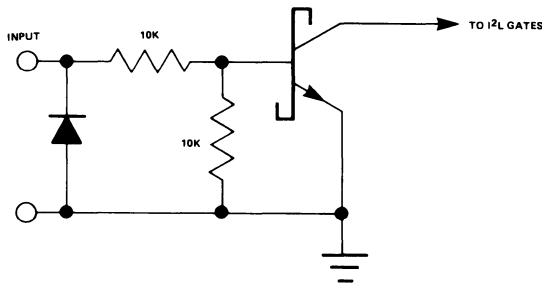

(a) Input Interface Circuit

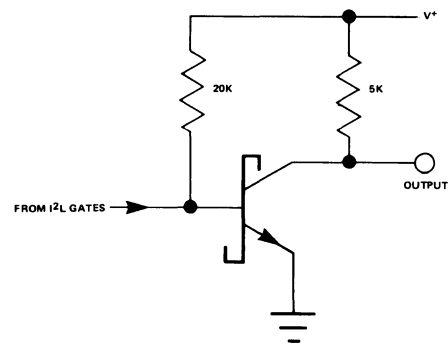

(b) Output Interface Circuit

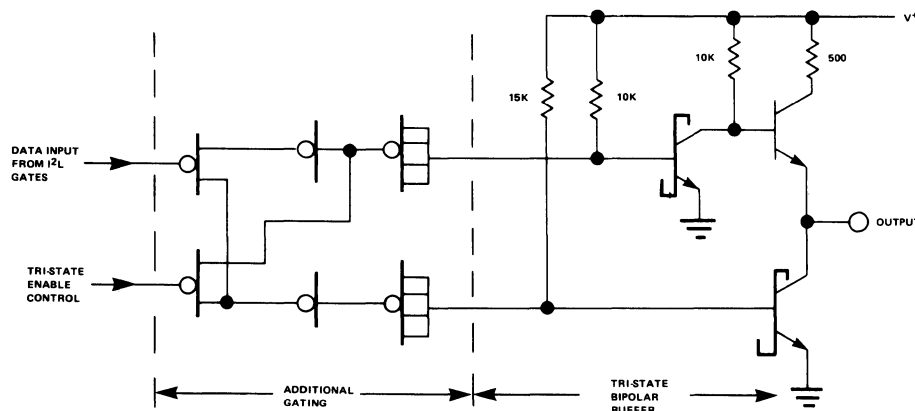

(c) Tri-State-Output Interface Circuit

Typical Bipolar Input/Output Interface Circuits Available from I/O Interface Cell

# XR-200 I<sup>2</sup>L Master Chip

Chip Size: 98 x 119 mils

5-Output I<sup>2</sup>L Gates: 192

Schottky-Bipolar I/O Interfaces: 24

Bonding Pads: 30

Max. Operating Voltage:

Option A: 6V

Option B: 12V

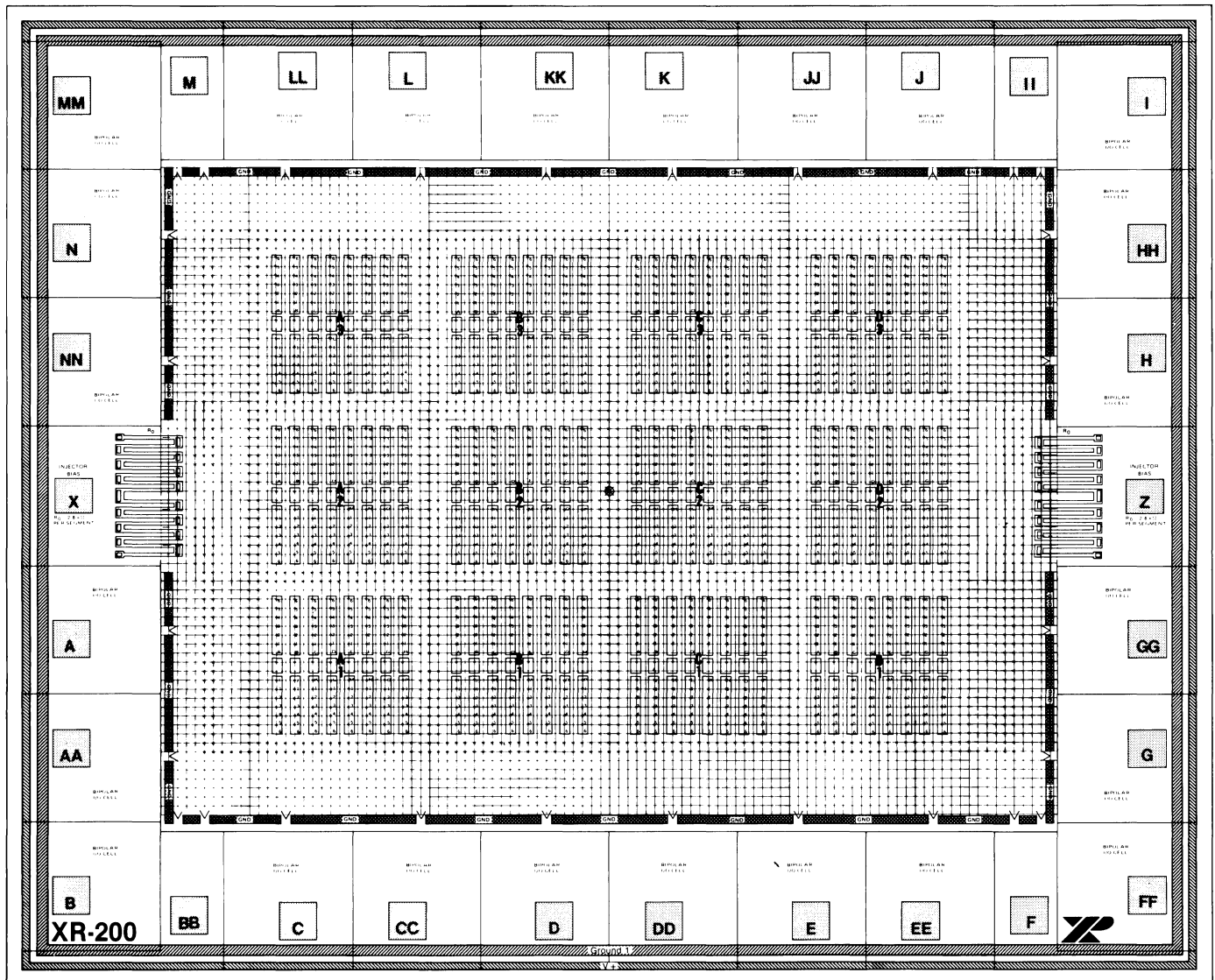
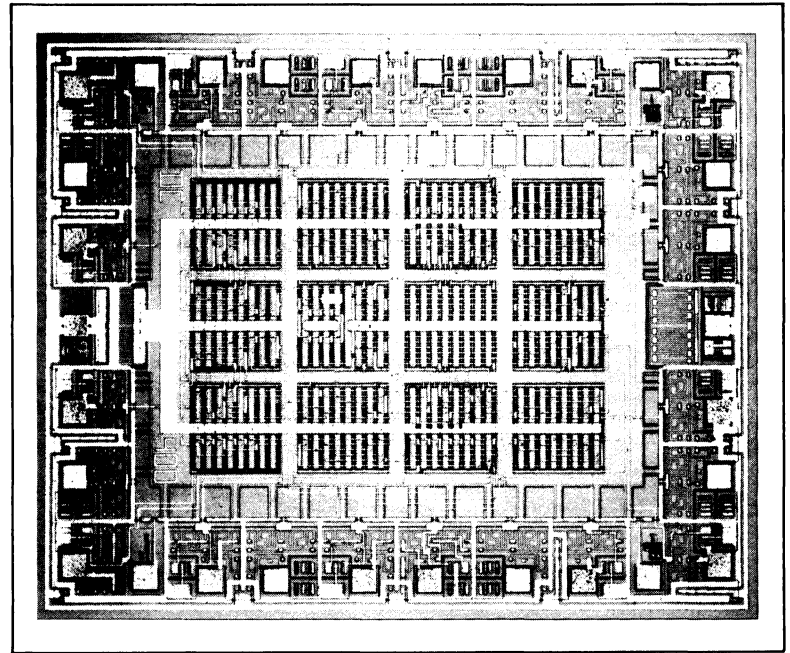



# XR-300 I<sup>2</sup>L Master Chip

Chip Size: 106 x 144 mils  
(2.7 x 3.7 mm)

5-Output I<sup>2</sup>L Gates: 288

Schottky-Bipolar I/O Interfaces: 28

Bonding Pads: 34

Max. Operating Voltage:

Option A: 6V

Option B: 12V

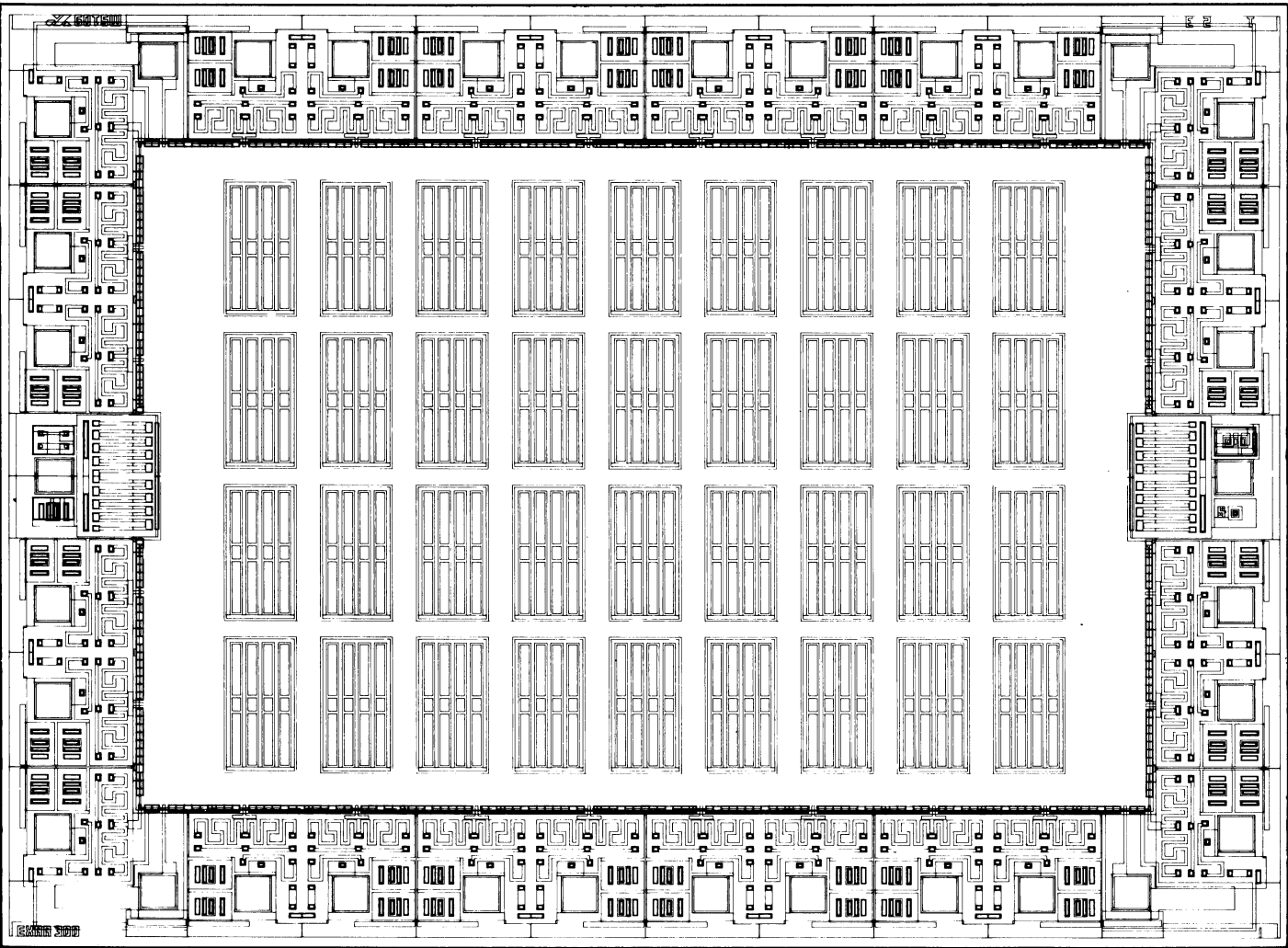
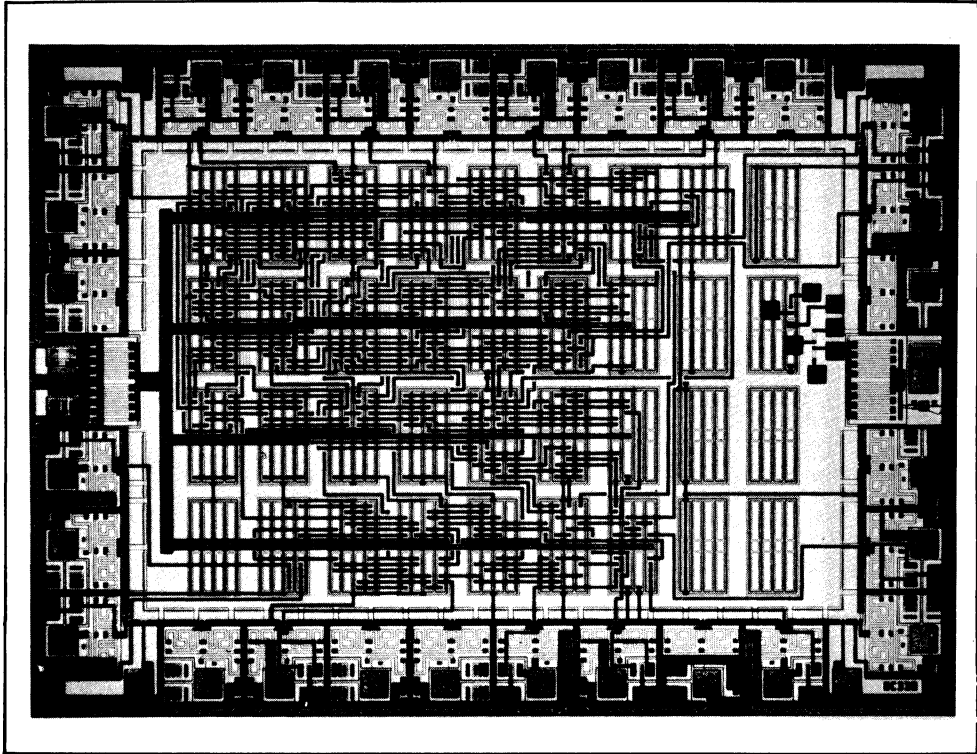

# XR-400 I<sup>2</sup>L Master Chip

Digital Components:

5-Output I<sup>2</sup>L Gates: 256

Schottky-Bipolar I/O Interfaces: 18

Bonding Pads: 40

Max. Operating Voltage:

Option A: 6 V

Option B: 12 V

Linear Components:

NPN Transistors: 45

4-Collector PNP Transistors: 12

Diffused Resistors:

700 Ω: 200

2.5 kΩ: 116

5kΩ: 20

Pinch Resistors: (Option B Only)

25 kΩ: 4

100 kΩ: 4

Chip Size: 119 x 149 mils

(3.02 x 3.96 mm)

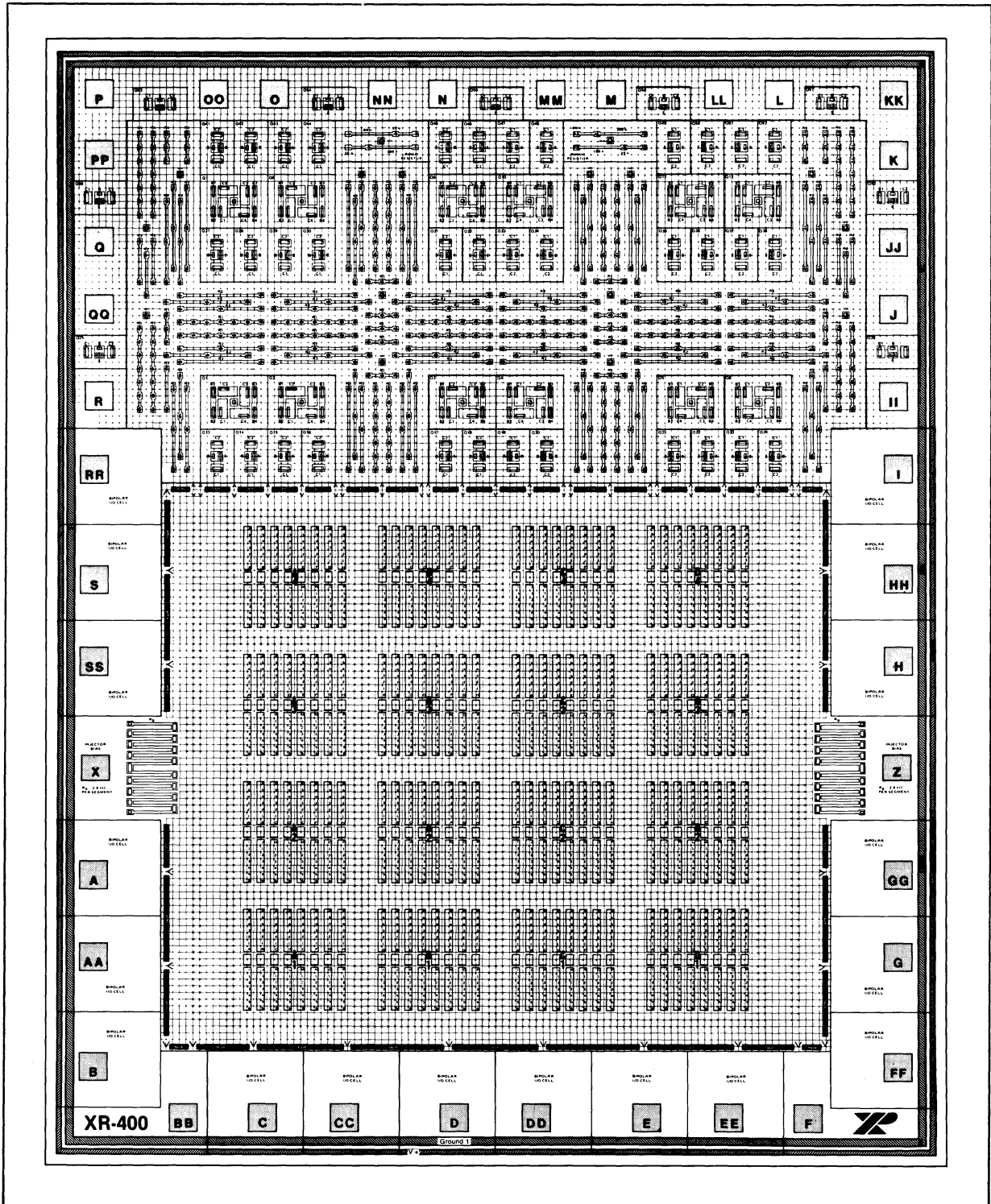

# XR-500 I<sup>2</sup>L Master Chip

Chip Size: 122 x 185 mils  
(3.1 x 4.6 mm)

5-Output I<sup>2</sup>L Gates: 520

Schottky-Bipolar I/O Interfaces: 40

Bonding Pads: 42

Max. Operating Voltage:

Option A: 6V

Option B: 12V

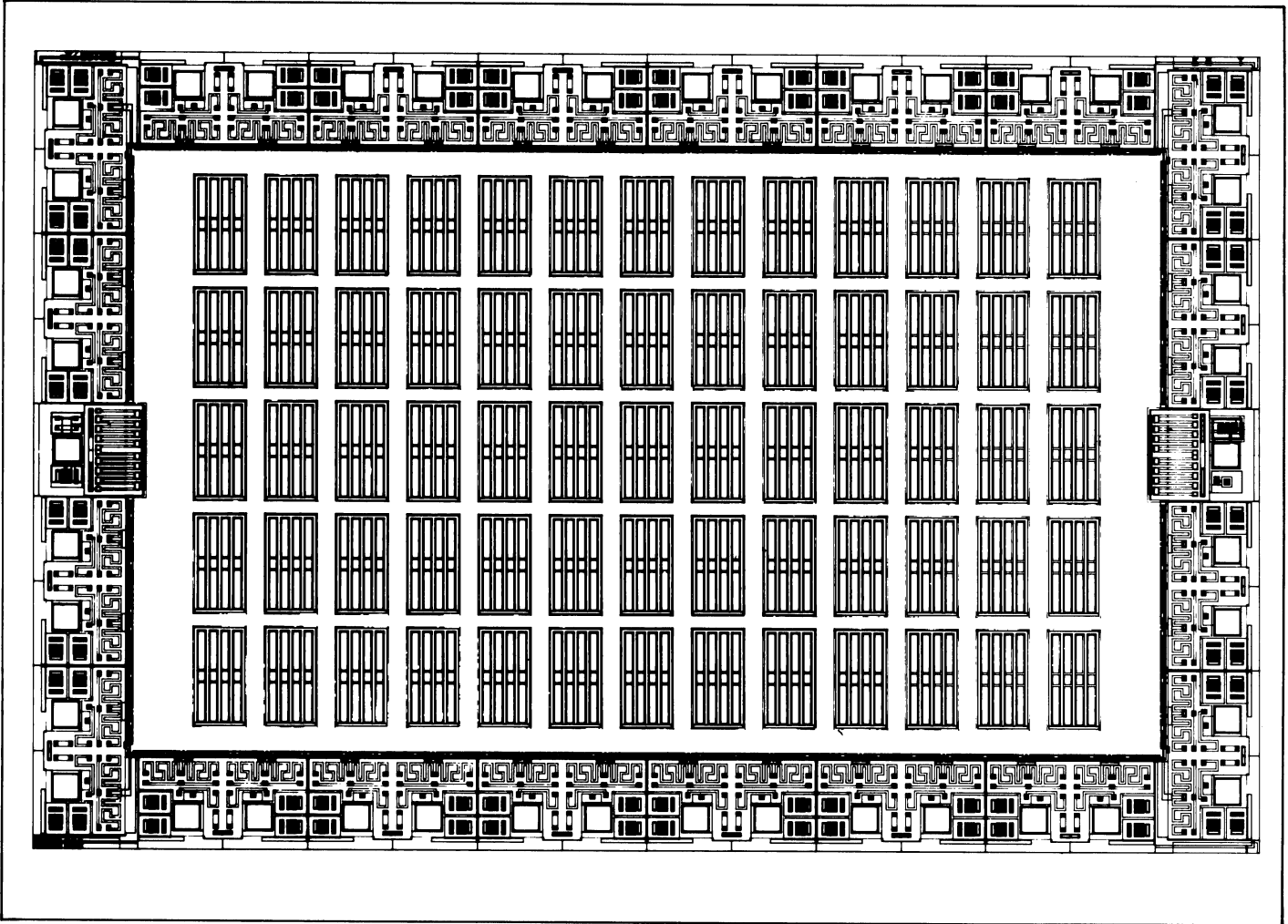
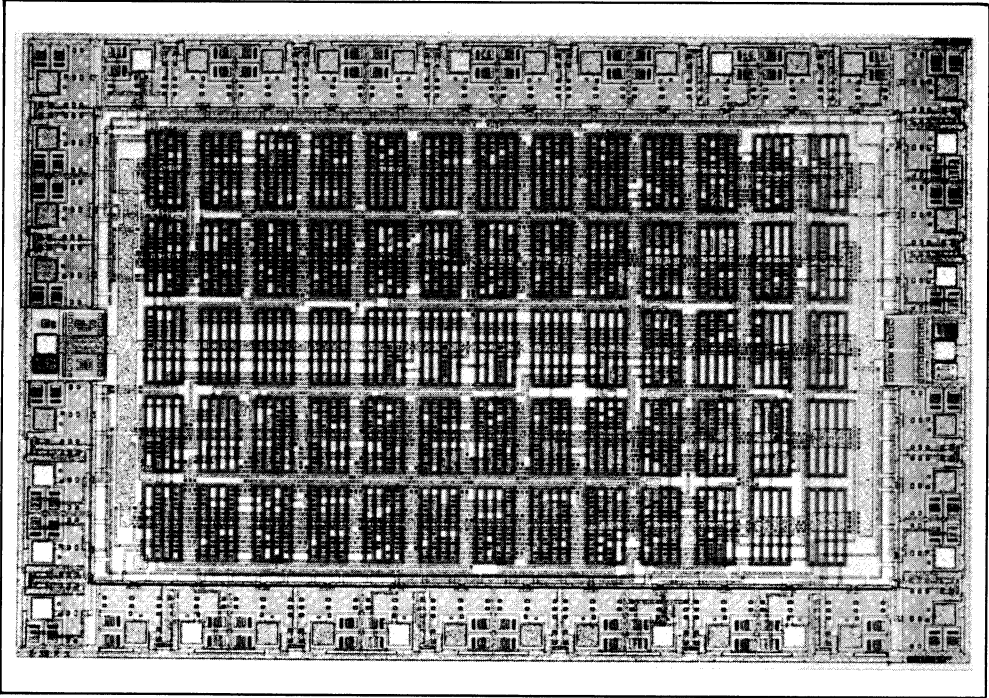

# Digital Semi-Custom Design Cycle

The digital semi-custom LSI design program using Exar's I<sup>2</sup>L Master Chips is devised for maximum versatility and flexibility, to suit varying customer needs and capabilities. The flow-chart below gives the outline and the sequence of *six* basic steps associated with a typical I<sup>2</sup>L semi-custom program.

In many cases, the *first two steps* indicated in the flow-chart can be done by the customer, in consultation with Exar, using Exar's I<sup>2</sup>L Design Kit and the design instruction manual. Whenever possible, such an approach is recommended, since it greatly reduces the development costs and the turnaround time.

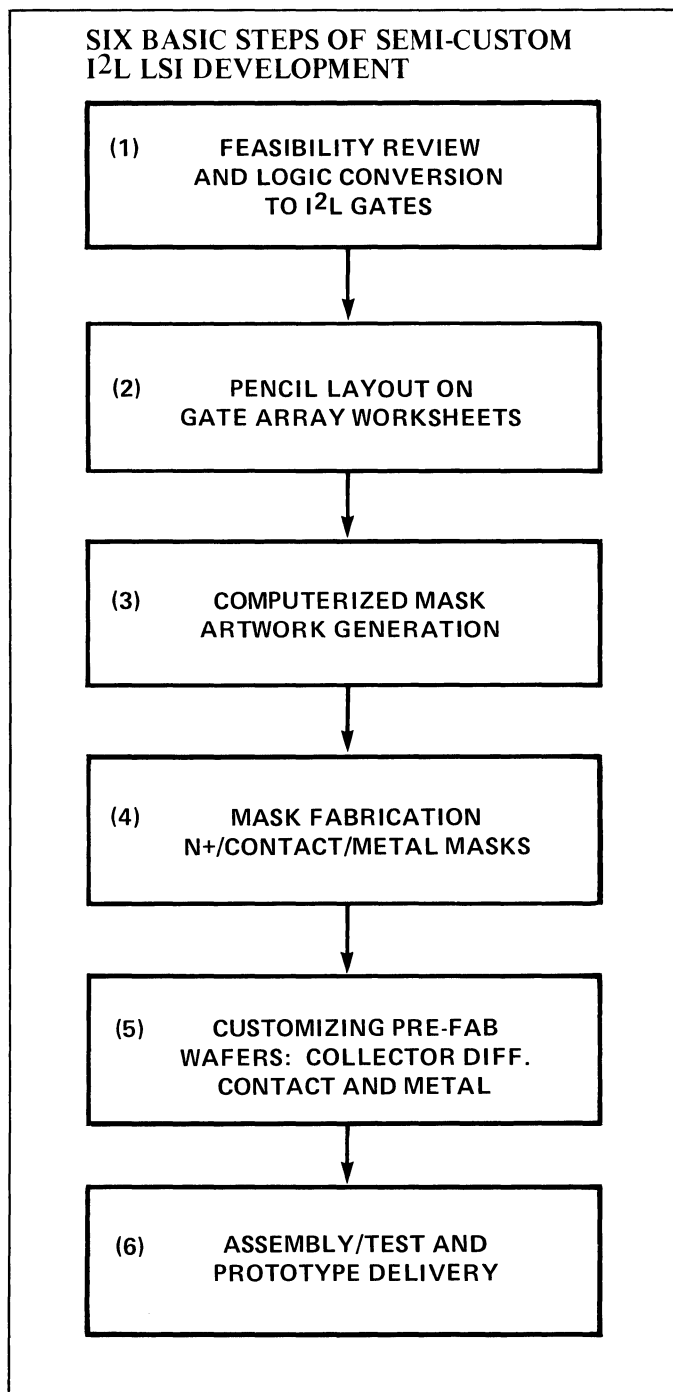

## STEP 1. FEASIBILITY REVIEW AND LOGIC CONVERSION

Starting with the customer's logic diagram (preferably reduced to flip-flops and gates) the first step is a detailed review of the system requirements with regards to the overall gate count, I/O requirements, operating speeds, etc., to assure feasibility of integration, and to choose the most economical gate array chip to be used. If the results of this review indicate feasibility, the next step is to convert the logic diagram into I<sup>2</sup>L gates. At this state, a computer simulation of the logic diagram may also be performed, if deemed necessary.

## STEP 2. PENCIL LAYOUT ON GATE ARRAY WORKSHEETS

Once the logic diagram is converted to I<sup>2</sup>L gates, the next step will be to make a pencil layout of the circuit on the appropriate array worksheet. This pencil layout is done on a blank worksheet where the gate input and output locations are shown as target dots (see page 25). During the layout, an appropriate symbol is placed over the corresponding dot on the gate outline, and the interconnections and the underpasses between the gates are indicated by pencil lines and with appropriate symbols. In this layout, the bipolar I/O cells do not need to be internally interconnected. Since these cells are standardized, it is only necessary for the designer to specify if a particular I/O cell is to be used as an input or an output.

## STEP 3. COMPUTERIZED MASK ARTWORK GENERATION

Using a specially developed computerized mask generation technique, the three layers of necessary custom IC tooling (i.e., for custom N-type diffusion, contact window cut; and the metal interconnections) can be automatically generated by a single "digitizing" step from the pencil layout. This simultaneous and automated generation of the three custom mask layers greatly reduces the tooling cost and turnaround time, and avoids mask errors.

## STEP 4. MASK FABRICATION

The photographic tooling plates, or "masks," are fabricated by a pattern-generation technique from the digitized coordinate information stored in the computer.

## STEP 5. CUSTOMIZING PREFABRICATED WAFERS

The prefabricated I<sup>2</sup>L wafers containing the P-type base diffusion and the gate "fingers" are customized into completed monolithic LSI chips using the custom IC tooling generated in Steps 3 and 4.

## STEP 6. ASSEMBLY/TEST AND PROTOTYPE DELIVERY

The completed monolithic chips are first evaluated on the finished IC wafer, and later assembled, electrically tested and delivered as the completed prototypes. The amount of electrical testing done on the initial prototypes depends on customer's specific needs and requirements.

# Exar's Digital Semi-Custom Programs

Exar offers two digital semi-custom development programs, using the I<sup>2</sup>L Master Chips:

**PROGRAM A:** *Exar Does Entire Design Starting From Customer's Logic Diagram:* Starting with customer's logic diagram, Exar proceeds to generate necessary IC layout and tooling; and fabricates the IC prototypes.

**PROGRAM B:** *Customer Does His Own Design Using I<sup>2</sup>L Design Kit:* Using the I<sup>2</sup>L Kit and the Design Manual, the customer can do his own breadboarding and pencil layout of his system on the Master Chip layout forms. Exar reviews this layout; generate necessary tooling and fabricates the IC prototypes.

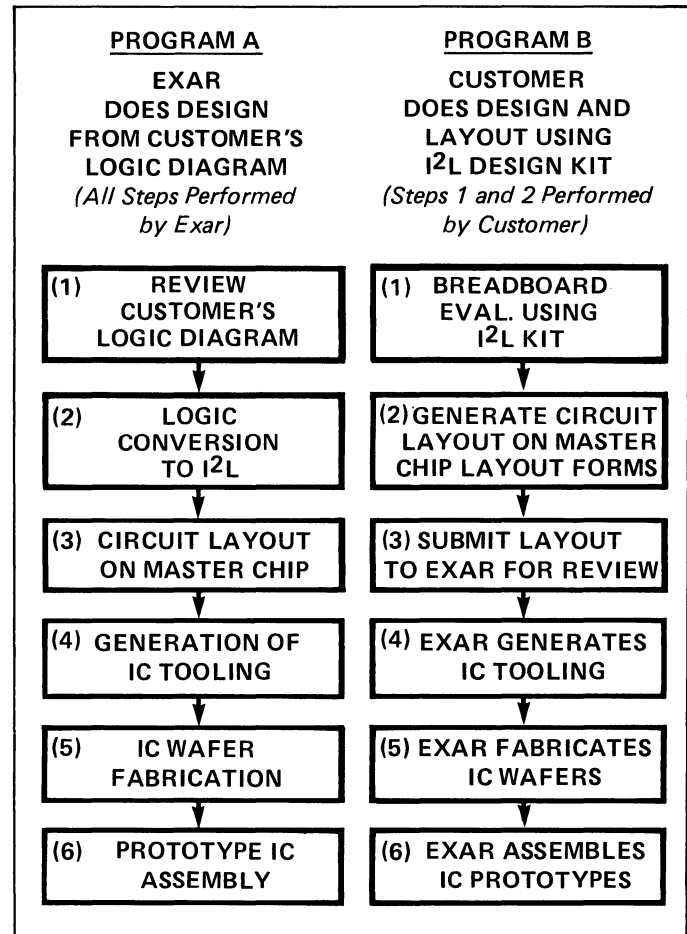

## DESIGN EXAMPLE

The multiple-output I<sup>2</sup>L gates on the Exar's Master Chips are arranged in 8-gate "cells." A complex logic array can be partitioned into sub-sections, and each of these sub-sections can be laid out on one or more of these cells. The example below shows the layout of a D-type flip-flop in one of Exar's Master Chips. The dark lines in the layout example correspond to the metal interconnection busses; the circles and squares indicate the respective gate outputs and inputs. As a part of the I<sup>2</sup>L Design Kit, Exar supplies a complete Design Manual and special layout worksheets which enable the customer to do his own logic-conversion and layout.

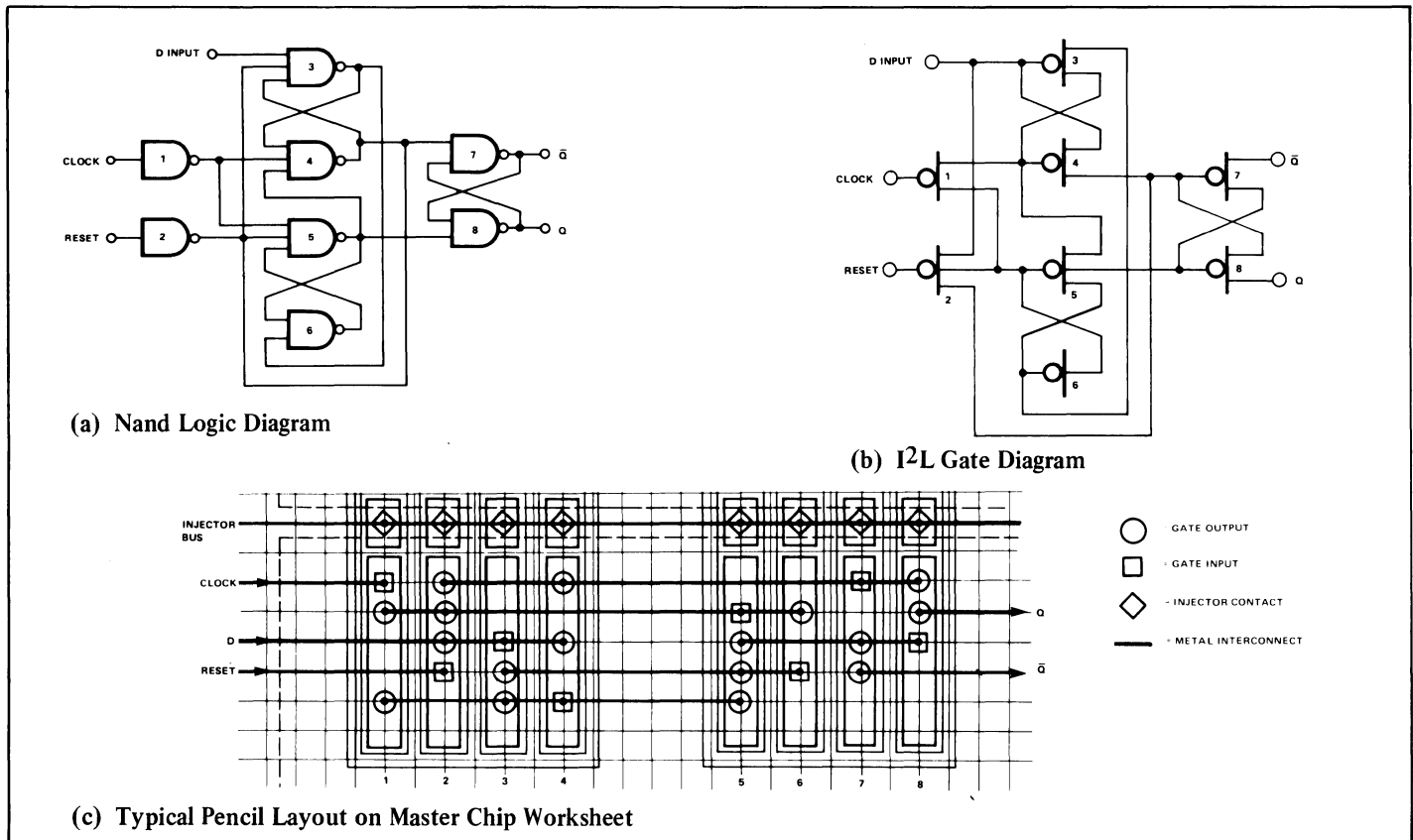



# I<sup>2</sup>L Design Kit

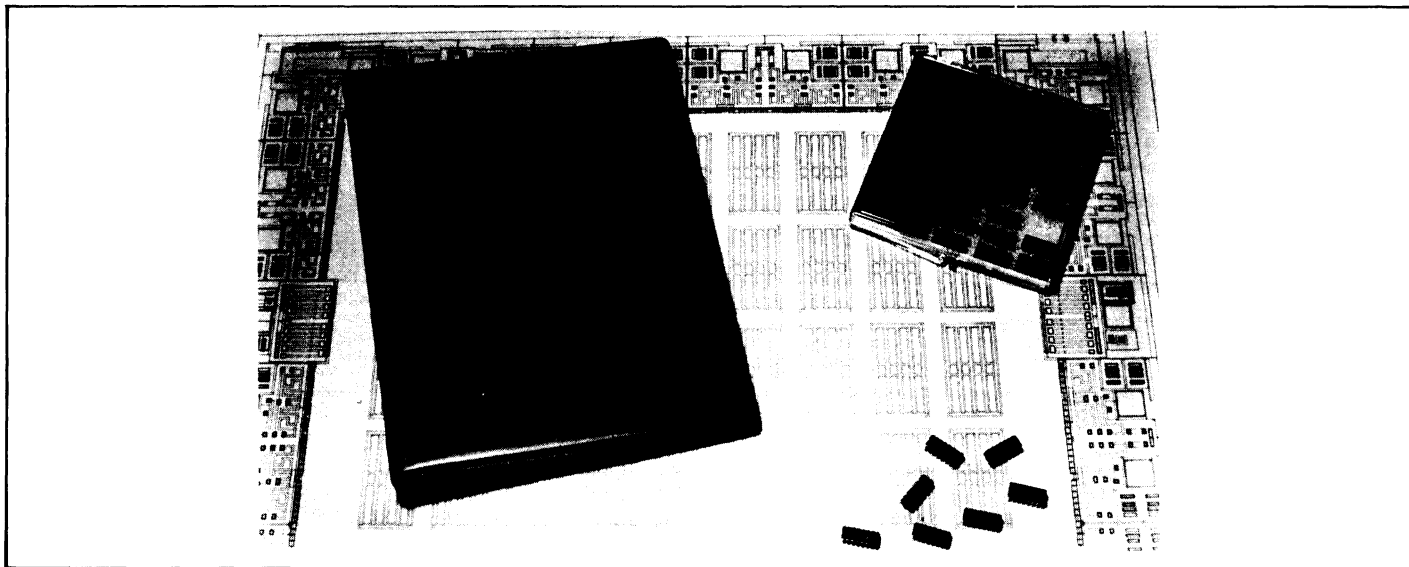

Exar's I<sup>2</sup>L Design Kit provides an ideal vehicle for the customer to familiarize himself with the fundamentals of I<sup>2</sup>L logic and then proceed to do the design and the layout of his own semi-custom I<sup>2</sup>L LSI chip. This Design Kit contains the following:

- A set of 40 monolithic "kit parts" for system design and breadboarding.
- A comprehensive "Design Manual" which covers the fundamentals of I<sup>2</sup>L logic and provides design and layout examples.
- A set of layout worksheets which lets the user prepare his own logic layout directly on the I<sup>2</sup>L Master Chip.

The monolithic kit parts which make up the I<sup>2</sup>L Design Kit are comprised of basic logic building blocks such as gate-arrays, latches and flip-flops as well as bipolar input/output buffers. The kit parts allow the designer to breadboard and characterize his circuit performance, and optimize his design, well in advance of performing the final circuit layout. In this manner, the problems and pitfalls normally encountered in converting a discrete logic system into a monolithic design are avoided. In addition, the kit also includes a special I<sup>2</sup>L evaluation or test chip, the XR-C409. This test circuit contains frequency-dividers and ring-oscillators to evaluate the high frequency capabilities and the power-speed trade-offs of I<sup>2</sup>L gates.

The I<sup>2</sup>L Design Manual gives a comprehensive review of I<sup>2</sup>L logic technology and describes the electrical characteristics of each type of component available in the Master Chips. It also presents some of the anticipated parameter distribution and the "worst-case" tolerances associated with each type of circuit component. In addition, the Design Manual also provides a "library" of I<sup>2</sup>L-equivalents of logic sub-blocks corresponding to popular logic functions such as decoders, flip-flops, counters and multiplexers and gives layout examples which demonstrate the efficient use of layout worksheets.

## ADDITIONAL KIT PARTS

The amount of kit parts supplied as a part of the I<sup>2</sup>L Design Kit are sufficient for most designs. However, if additional kit parts are required to complete your evaluation, these can be obtained either directly from Exar, or through your local Exar technical representative.

## TECHNICAL ASSISTANCE

If any special or unusual circuit design or layout problems are encountered in the preparation of your semi-custom IC layout Exar's technical staff will be glad to review your design problem and provide technical guidance. In many cases, it is beneficial to call Exar for a preliminary discussion of your custom IC needs, even before you decide to buy a Design Kit.

## COMPONENTS INCLUDED IN I<sup>2</sup>L DESIGN KIT

PART NUMBER	DESCRIPTION	QUANTITY
XR-C501	I <sup>2</sup> L Triple Inverter Array	15
XR-C502	Quad NOR-Gate Array	4
XR-C503	Dual D-type Flip-Flop (unbuffered)	8
XR-C504	Dual D-type Flip-Flop with Bipolar I/O Buffers	2
XR-C505	Dual J-K Flip-Flop (unbuffered)	4
XR-C506	I <sup>2</sup> L Compatible NPN Transistor Array	4
XR-C507	I <sup>2</sup> L Compatible PNP Transistor Array	2
XR-C409	I <sup>2</sup> L Evaluation Circuit	1
	Total	<hr/> 40

# Components in I<sup>2</sup>L Design Kit

**NOTE:** When breadboarding with I<sup>2</sup>L kit parts included in the Design Kit, a word of caution is in order: The high-frequency capabilities of I<sup>2</sup>L gates in the kit which have unbuffered outputs are to a large extent limited by the parasitic capacitances associated with the package or the external wiring on the circuit board. In the monolithic design, when the electrical connections are made internal to the chip and the outputs are buffered, these parasitic package capacitances do not present a problem. However, when breadboarding with I<sup>2</sup>L kit parts which have no buffered outputs, these package capacitances may limit the switching speeds obtainable at the kit-part breadboard stage.

## XR-C502 I<sup>2</sup>L NOR-GATE ARRAY

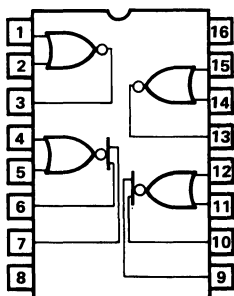

XR-C502 contains two single- and two dual-output I<sup>2</sup>L NOR gates. All four gates share a common injector.

Pin 16 = Injector  
Pin 8 = Ground

## XR-C501 I<sup>2</sup>L INVERTER ARRAY

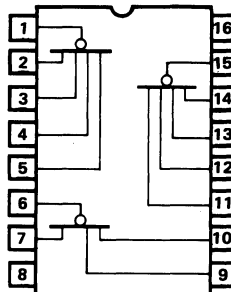

XR-C501 contains three multiple-output I<sup>2</sup>L inverters. These three gates each have independent inputs and outputs, however they share a common injector.

Pin 16 = Injector  
Pin 8 = Ground

## XR-C503 DUAL "D" FLIP-FLOP

## XR-C503 DUAL "D" FLIP-FLOP

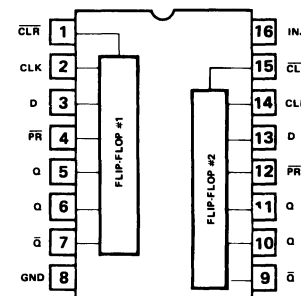

XR-C503 contains two independent D-type flip-flops. Both flip-flops share a common injector and trigger on positive-going edges. Both the inputs and the outputs of each flip-flop are unbuffered.

Pin 16 = Injector  
Pin 8 = Ground

## XR-C504 BUFFERED DUAL-D FLIP-FLOP

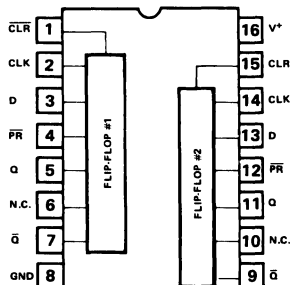

XR-C504 is a "buffered" version of the XR-C503 flip-flop array. Both flip-flops contain Schottky-bipolar input and output buffers (see page 26). The two flip-flops share a common injector which is internally connected to V<sup>+</sup> terminal. With V<sup>+</sup> = 5V, the I<sup>2</sup>L gates are biased at approximately 50μA/gate and are positive edge triggered.

Pin 16 = V<sup>+</sup>  
Pin 8 = Ground  
Option

## XR-C505 DUAL J-K FLIP-FLOP

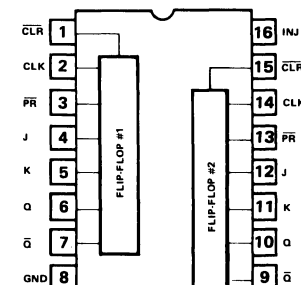

XR-C505 contains two independent J-K flip-flops which share a common injector. Both the inputs and outputs are comprised of unbuffered I<sup>2</sup>L gates. Both flip-flops are positive edge triggered.

Pin 16 = Injector  
Pin 8 = Ground

## XR-C506 I<sup>2</sup>L COMPATIBLE NPN TRANSISTOR ARRAY

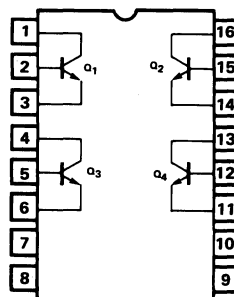

XR-C506 contains four small-signal NPN transistors. These are equivalent to the transistors available in the linear section of the XR-400 Master Chip.

Pin 8 = Substrate

## XR-C507 I<sup>2</sup>L COMPATIBLE PNP TRANSISTOR ARRAY

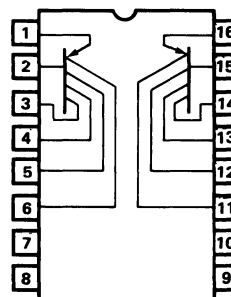

XR-C507 contains two four-collector lateral PNP transistors. These devices are equivalent to the PNP transistors available in the linear section of the XR-400 Master Chip.

Pin 8 = Substrate

# XR-C409 I<sup>2</sup>L Evaluation Circuit

The XR-C409 monolithic IC is a test circuit for evaluating the speed and performance capabilities of Exar's Integrated Injection Logic (I<sup>2</sup>L) technology. It is intended to familiarize the I<sup>2</sup>L user and the digital system designer with some of the performance features of I<sup>2</sup>L, such as its high-frequency capability and power-speed tradeoffs.

The XR-C409 I<sup>2</sup>L test circuit is comprised of five separate evaluation blocks as shown in Figure 1. Blocks 1 and 2 are D-type flip-flops which are internally connected as frequency dividers. Each of these dividers provides buffered open-collector outputs. Blocks 3, 4, and 5 are 8-stage ring-oscillators with buffered outputs to be used for measuring gate propagation delays at different injector current levels. The XR-C409 evaluation circuit is included as a part of Exar's I<sup>2</sup>L Design Kit.

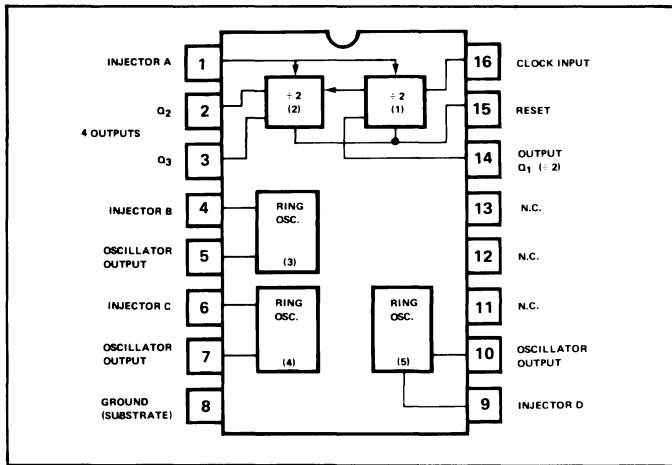

Figure 1: Package Terminals for XR-C409

## FREQUENCY DIVIDER SECTION

The frequency divider sections of the XR-C409 test circuit are made up of two D-type flip-flops internally connected in the ( $\div 2$ ) mode. These frequency dividers are operated with *serial* clocking and *parallel* reset controls. The flip-flops operate on the negative-transitions of the clock input, and reset with a "high" logic state. When the circuit is reset, all the outputs go to a "low" state. The logic polarities and the timing sequence of the circuit waveforms are shown below in Figure 2.

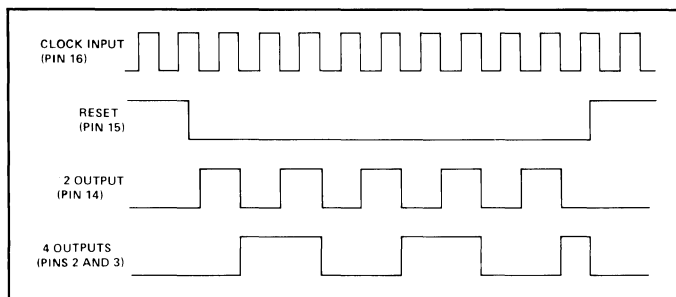

Figure 2: Timing Diagram for Frequency Divider Section

## RING-OSCILLATOR SECTIONS

The ring-oscillator sections of the XR-C409 test circuit are intended for the measurement of propagation delays associated

with I<sup>2</sup>L gates. Each of these oscillators is made up of a cascade of 8 four-output I<sup>2</sup>L gates. The basic gate operates as an inverter with a single input and four outputs as shown in Figure 3 below.

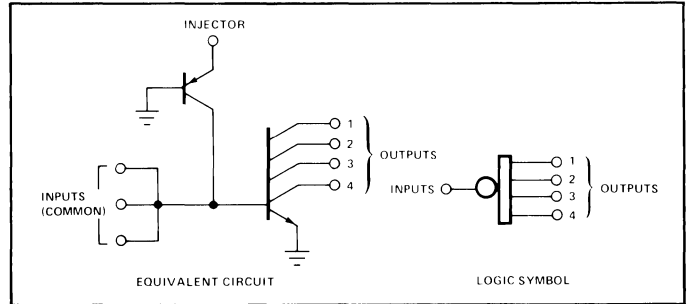

Figure 3: Four-Output I<sup>2</sup>L Gate

Figure 4 shows the basic seven-stage ring-oscillator circuits included on the XR-C409 chip. Since the delay characteristics depend on the choice and the number of gate outputs used, the test IC includes three separate ring oscillator sections. The ring oscillator of Figure 4(a) corresponds to section (3) in the package diagram of XR-C409 shown in Figure 1. This oscillator uses only one gate-output per gate. The output used is the one closest to the injector, with the remaining outputs left open-circuited.

The ring-oscillator of Figure 4(b) uses two gate outputs per stage. The outputs used are the two closest to the injector. The ring oscillator of Figure 4(c) has all four outputs shorted together.

All three oscillator sections of XR-C409 have *separate* injectors, but share a common ground (pin 8). Each oscillator also has a separate output buffer stage.

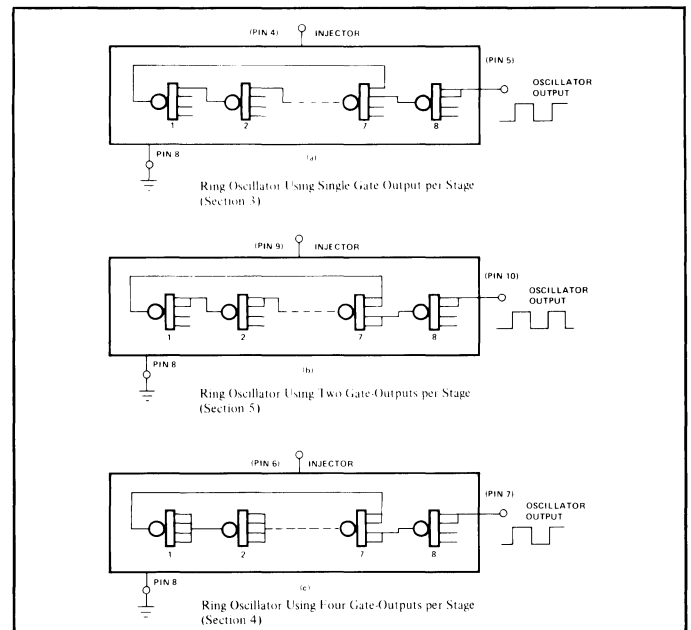

Figure 4: Equivalent Circuits of the 7-Stage Ring Oscillator Section

# Electrical Characteristics of I<sup>2</sup>L Master Chip Components

## I<sup>2</sup>L GATES (All Master Chips)

PARAMETER	TYPICAL CHARACTERISTICS AT VARIOUS INJECTOR CURRENTS			
	I <sub>j</sub> = 100nA	I <sub>j</sub> = 1μA	I <sub>j</sub> = 10μA	I <sub>j</sub> = 100μA
Output Sink Current, I <sub>O</sub>	300 nA	8 μA	80 μA	600 μA
Output Sat. Voltage, V <sub>OL</sub>	3mV	3mV	4mV	10mV
Input Threshold	0.48V	0.54V	0.60V	0.66V
Power-Delay Product (V <sup>+</sup> = 1V)	0.6 pJ	0.6 pJ	1.0 pJ	3 pJ
Average Prop. Delay	6 μsec	0.6 μsec	100 nsec	50 nsec
Max. Toggle Freq. (D F/F)	6 kHz	60 kHz	400 kHz	2 MHz
Input OFF Current (V <sub>IN</sub> = 0)	150 nA	1.5 μA	15 μA	130 μA
Output Breakdown Voltage (Unbuffered Output)	3V	3V	3V	3V

## SMALL SIGNAL NPN TRANSISTORS (Linear Section of XR-400 Chip Only)

PARAMETER	TEST CONDITION	TYPICAL VALUES	SIGMA LIMIT	WORST CASE TOLERANCE
Current Gain (h <sub>FE</sub> )	I <sub>C</sub> = 1 mA, V <sub>CE</sub> =	200	—	80 – 800
Temp. Coefficiency of h <sub>FE</sub>	–55°C to +25°C	+0.5%/°C	—	—
	25°C to 125°C	+1%/°C		
Matching of h <sub>FE</sub>	I <sub>C</sub> = 1 mA	—	±5%	±20%
Breakdown Voltage	LV <sub>CEO</sub>			
Option A		8V		6 – 10V
Option B		15V		15 – 20V
Cutoff Frequency (f <sub>T</sub> )	I <sub>C</sub> = 1 mA	500 MHz		
Saturation Resistance		50 Ω		30 – 100 Ω

## LATERAL PNP TRANSISTORS (Linear Section of XR-400 Only)

PARAMETER	TEST CONDITION	TYPICAL VALUES	SIGMA LIMIT	WORST CASE TOLERANCE
Current Gain (h <sub>FE</sub> )	I <sub>C</sub> = 100 μA	10		5 – 20
(All collectors shorted)	I <sub>C</sub> = 10 μA	30		10 – 50
Temp. Coefficiency of h <sub>FE</sub>	I <sub>C</sub> = 10 μA	±0.1%/°C		
Matching of h <sub>FE</sub>	I <sub>C</sub> = 10 μA	±3%	±5%	
Breakdown Voltage	LV <sub>CEO</sub>	25V		15 – 30V
Cutoff Frequency (f <sub>T</sub> )	I <sub>C</sub> = 100 μA	5 MHz		

# Typical Performance Characteristics of I<sup>2</sup>L Gates

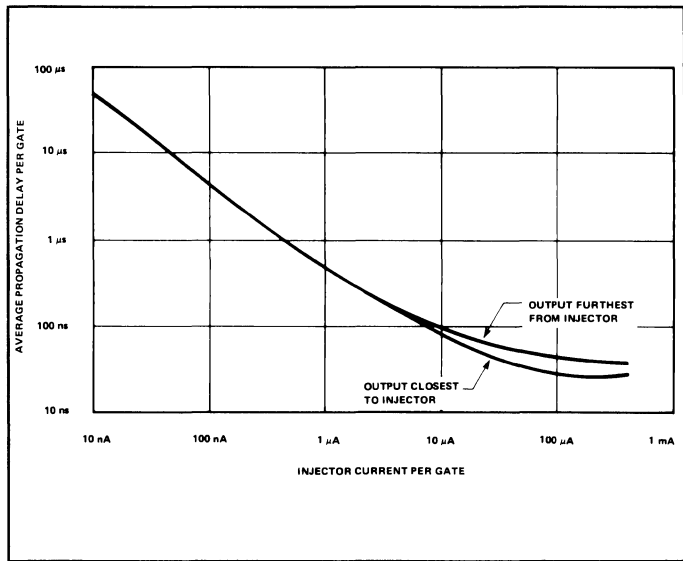

Propagation Delay Characteristics of I<sup>2</sup>L Gates as a Function of Injector Current.

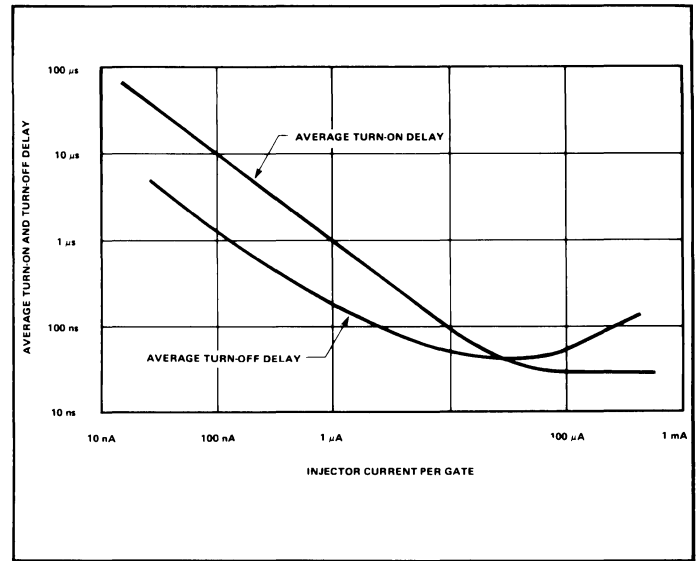

Average Turn-On and Turn-Off Delay vs. Injector Current.

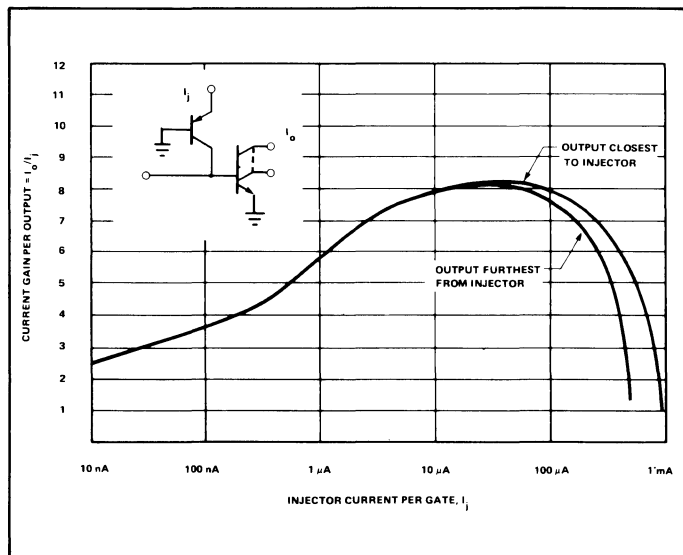

Composite Current Gain as a Function of Injector Current.  
(Note: Composite gain is defined as the ratio of maximum output current to injector current.)

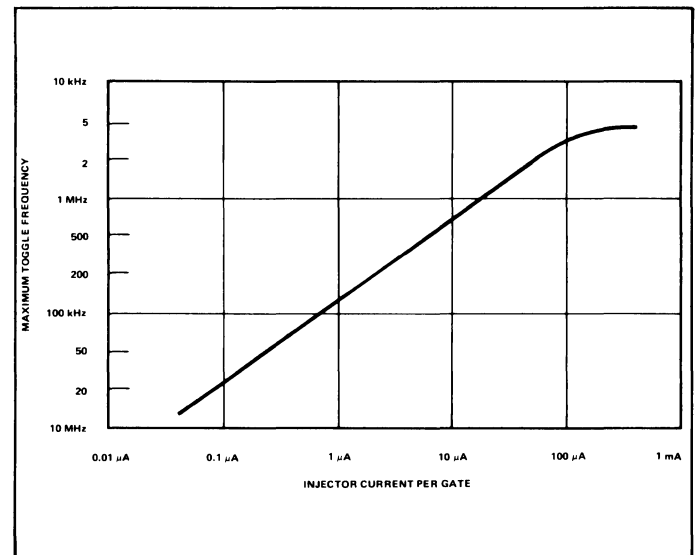

Maximum Toggle Rate of D-Type Flip-Flop as a Function of Injector Current.

# Quality Assurance Standards

The quality assurance program at Exar Integrated Systems defines and establishes standards and controls on manufacturing, and audits product quality at critical points during manufacturing. The accompanying Manufacturing/QA process flows illustrate where quality assurance audits, by inspection or test, the manufacturing process. The insertion of these quality assurance points is designed to

insure the highest quality standards are maintained on Exar product during its manufacture. Realizing that these standard Manufacturing/QA process flows do not meet the needs of every customer's specific requirements, Exar quality assurance can negotiate and will screen product to meet any individual customer's specific requirement.

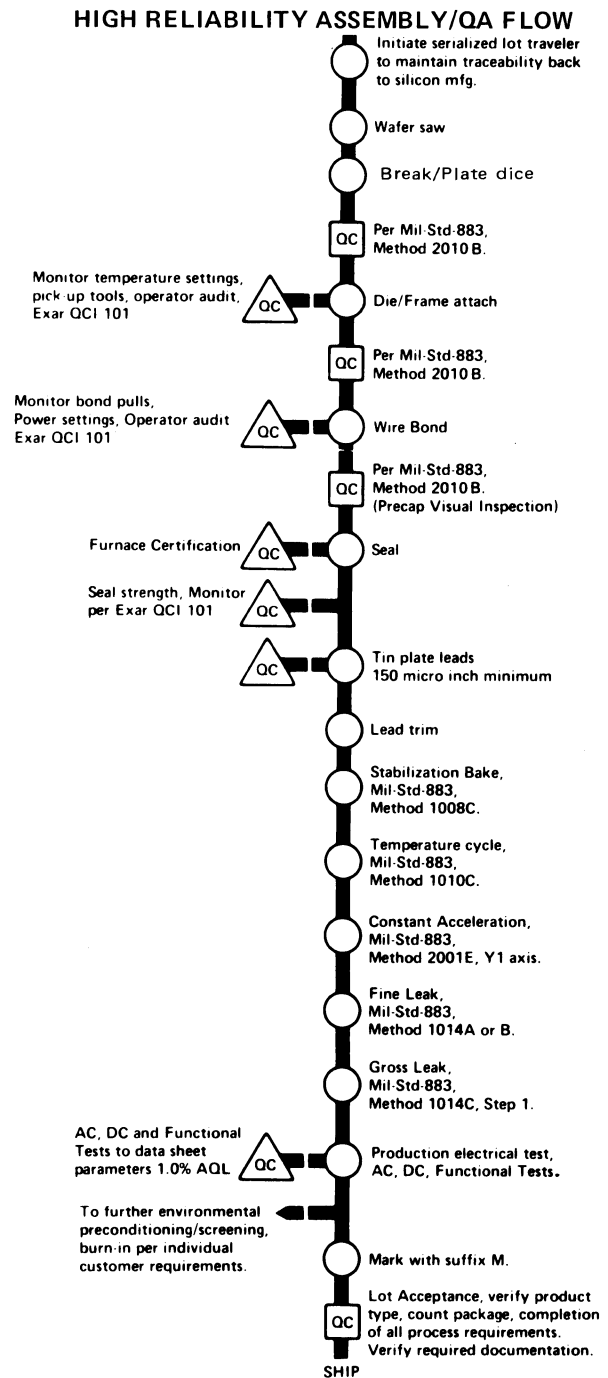
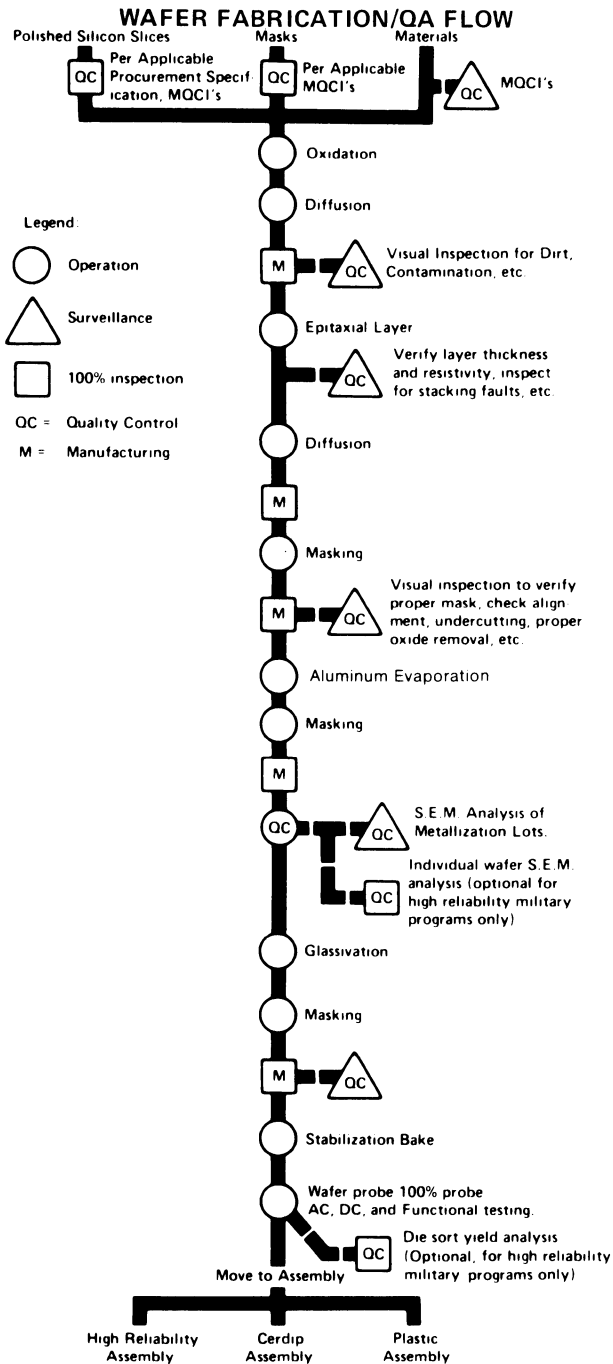

### CERDIP ASSEMBLY/QA FLOW

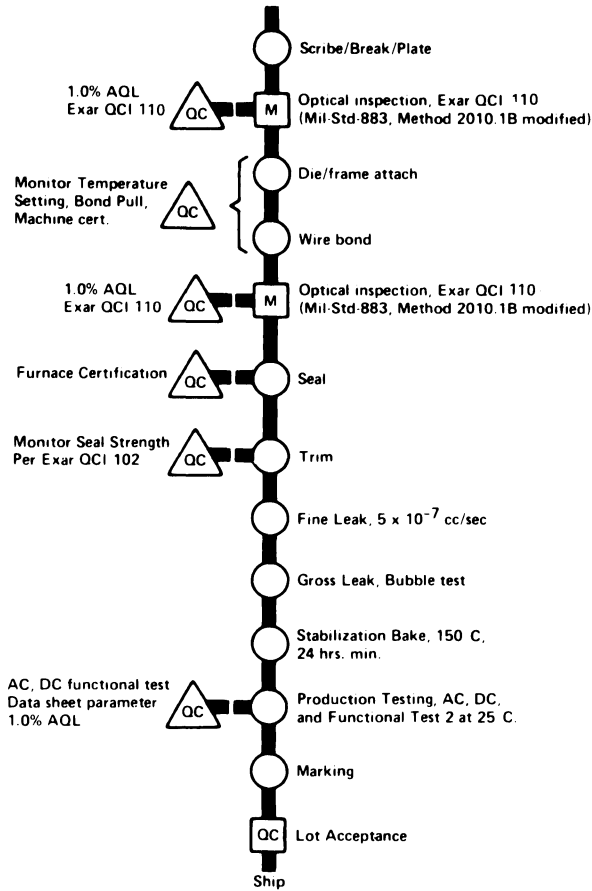

### PLASTIC ASSEMBLY/QA FLOW

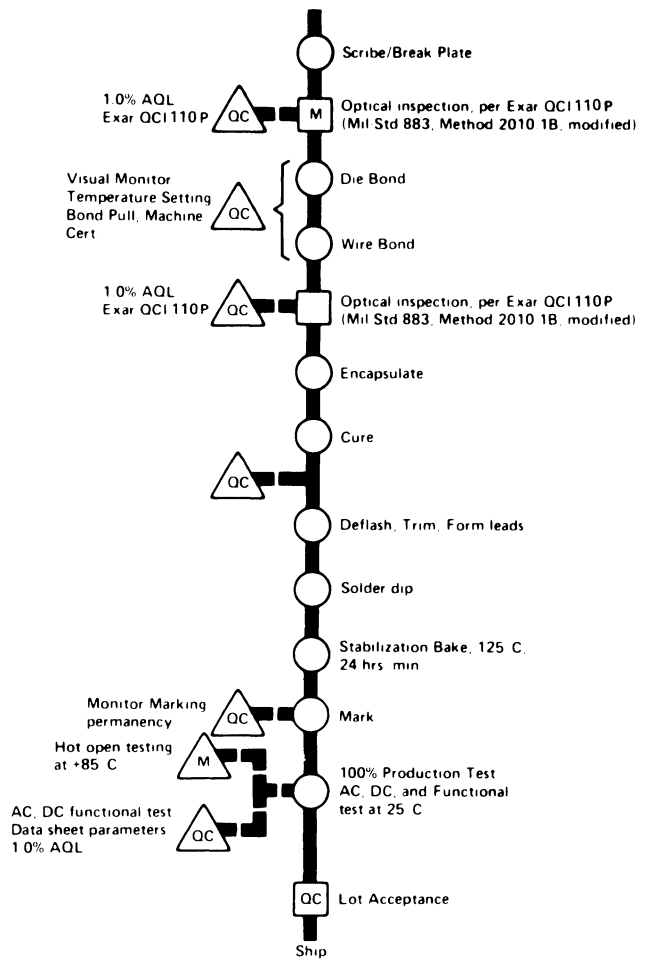

## Monolithic Chips for Hybrid Assemblies

All of Exar's semi-custom IC products are also available in chip form. All chips are 100% electrically tested for guaranteed DC parameters at 25°C; and 100% visually inspected at 30x to 100x magnification using Exar's standard visual inspection criteria or MIL-STD-883 Method 2001, depending

on the individual customer requirements. Each chip is protected with an inert glass passivation layer over the metal interconnections. The chips are packaged in waffle-pack carriers with an anti-static shield and cushioning strip plated over the active surface to assure protection during shipment. All chips are produced on the same well-proven production lines that produce Exar's standard encapsulated devices. The Quality Assurance testing of dice is provided by normal production testing of packaged devices.

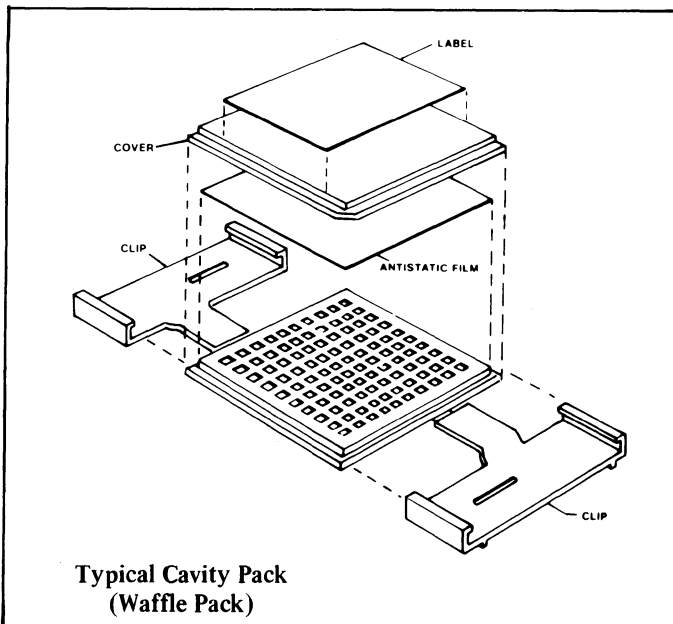

### HANDLING PRECAUTIONS AND PACKAGING OPTIONS

Extreme care must be used in the handling of unencapsulated semiconductor chips or dice to avoid damage to the chip surface. Exar offers the following three handling or packaging options for monolithic chips supplied to the customer:

**Cavity or Waffle Pack:** The dice are placed in individual compartments of the waffle pack (see figure). The plastic snap clips permit inspection and resealing.

**Vial Pack:** The vial is filled with inert freon TF and a plastic cap seals the vial. The freon acts as a motion retarder and cleansing agent.

**Wafer Pack:** The entire wafer is sandwiched between two pieces of mylar and vacuum sealed in a plastic envelope.



# Packaging Information

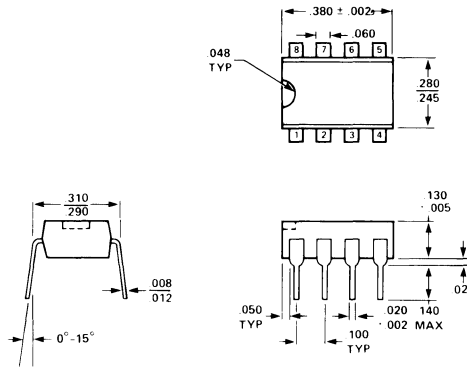

**8 PIN MOLDED PLASTIC DIP**

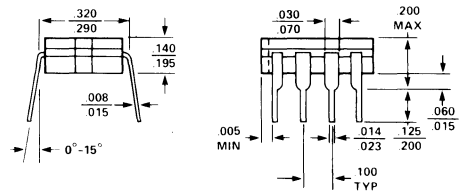
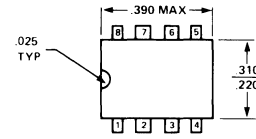

**8 PIN CERAMIC CAVITY DIP (CERDIP)**

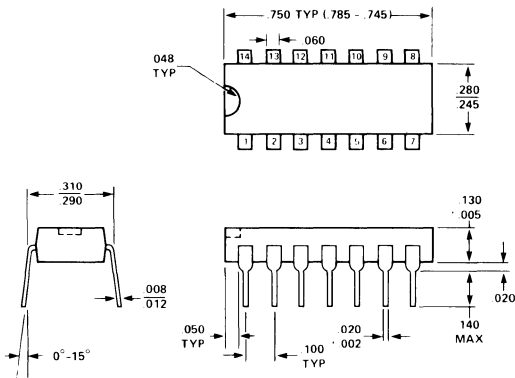

**14 PIN MOLDED PLASTIC DIP**

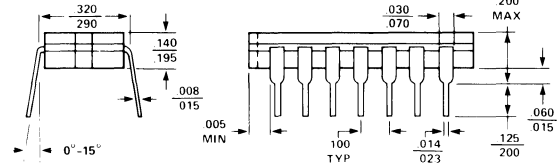
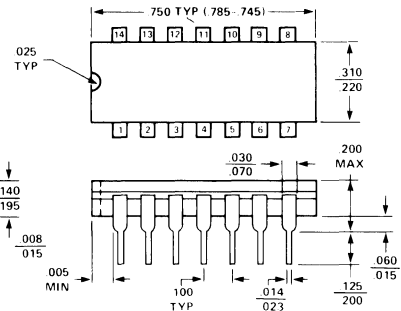

**14 PIN CERAMIC CAVITY DIP (CERDIP)**

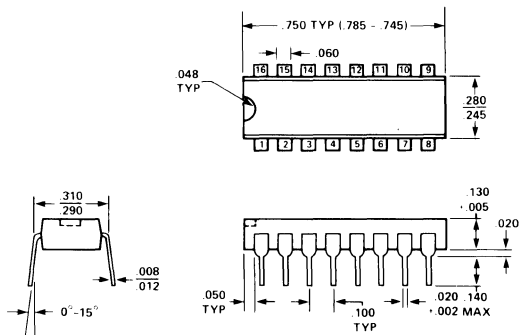

**16 PIN MOLDED PLASTIC DIP**

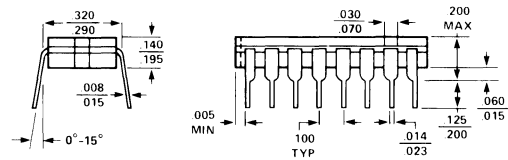
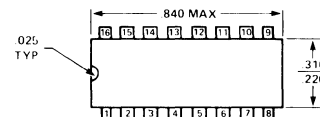

**16 PIN CERAMIC CAVITY DIP (CERDIP)**

# Packaging Information

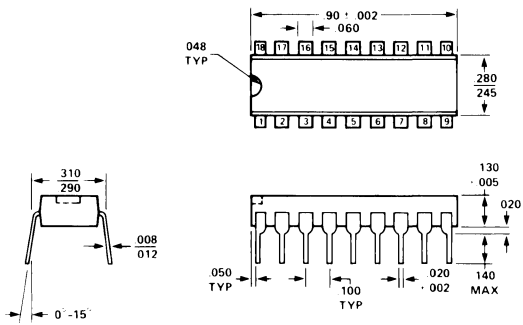

18 PIN MOLDED PLASTIC DIP

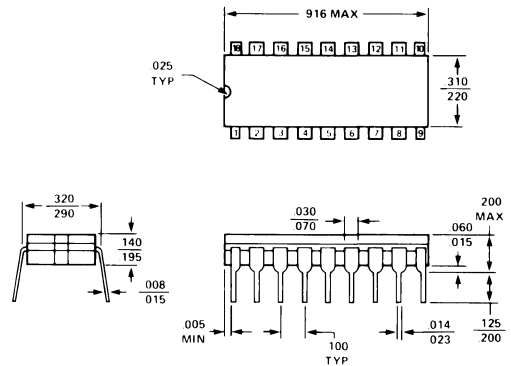

18 PIN CERAMIC CAVITY DIP

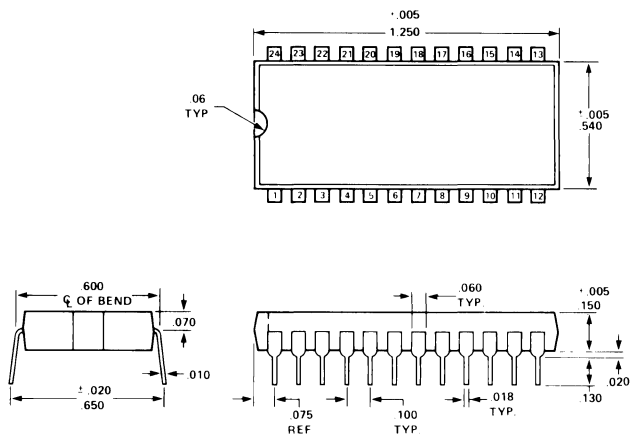

24 PIN MOLDED PLASTIC DIP

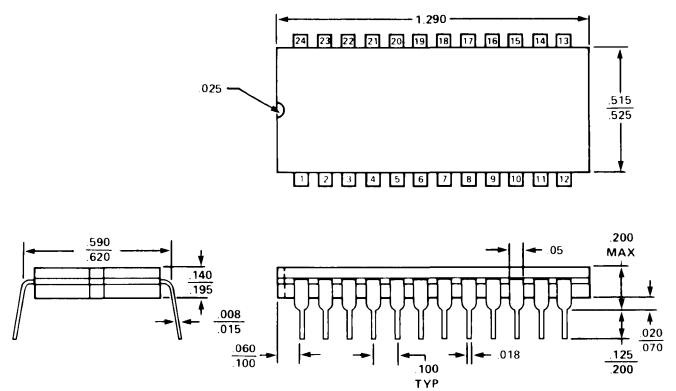

24 PIN CERAMIC CAVITY DIP

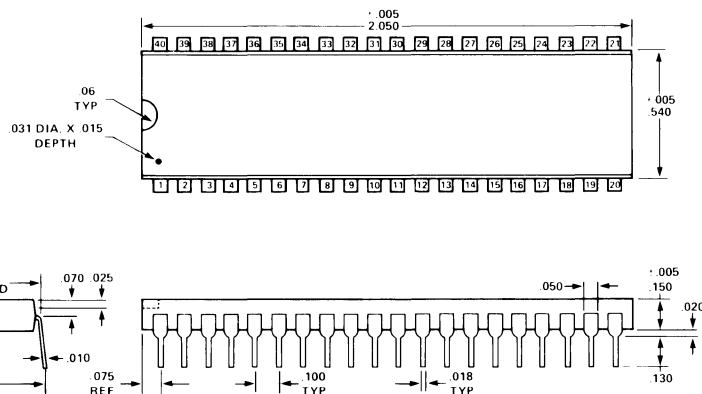

40 PIN MOLDED PLASTIC DIP

# INTERNATIONAL SALES OFFICES AND REPRESENTATIVES

## ARGENTINA

Rayo Electronics SRL  
Belgrando 990  
Pisos 6Y2  
Phone: 37 98 90  
Telex: (390) 122153 (RAYOX AR)

## AUSTRALIA

Total Electronics  
310 Queen St. Melbourne  
G.P.O. Box 1286K  
Melbourne, 3001  
Phone: 67 9306  
Telex (790) 31261 (TOTELEC AA)

## BELGIUM

(See Germany)

## BRASIL

R.Ohm Do Brasil Industria Electronica Ltda.  
Av. Dom Pedro I, 420  
01552 Sao Paulo  
Telex: (391) 1121178 (UIEL BR)

## DENMARK

Mer-el A/S  
Ved Klædebo 18  
DK-2970 Hørsholm  
Phone: 571000  
Telex: (855) 37360 (MEREL DK)

## FINLAND

S W Instruments  
Karstulantie 4  
SF-00550 Helsinki 55  
Phone: 83 82 65/76 24 86  
Telex: (857) 12/2411 (SWI)

## FRANCE

Tekelec/Airtronic  
Rue Carle Vernet  
F-92310 Sevres  
Phone: (1) 534 75 35  
Telex: (842) 204552 (TKLEC A)

## GERMANY (WEST)

R.Ohm Electronics GmbH  
D-4051 Korschenbroich  
Muehlenstrasse 70  
Phone: (02161) 29 805  
Telex: (841) 852330 (ROHM D)

## GREECE

General Electronics Ltd.  
209 Thevon Street  
Nikaia 77, Piraeus  
Phone: 49 13 595  
Telex: (863) 212949 (GELT GR)

## HONG KONG

R.Ohm Electronics (H.K.) Co., Ltd.  
Rm 1027A, Ocean Centre  
5, Canton Road, Tsimshatsui,  
Kowloon  
Phone: 3-688841/3-672307  
Telex: (780) 37503 (REHCL HX)

## INDIA

Zenith Electronics  
541 Panchratna  
Mama Parmanand Marg  
Bombay 400004  
Phone: 38 42 14  
Telex: (953) 11 3152 (ZINTH IN)

## ISRAEL

CVS Technologies 1974 Ltd.  
8 Hashalom Road  
Tel Aviv  
Phone: 330190  
Telex: (922) 341363 (MEIS IL)

## ITALY

Eledra 3S S.p.A.  
Viale Elvezia, 18  
20154 Milano  
Phone: 34.93.041  
Telex: (843) 332332 (ELEDRA I)

## JAPAN

Tokyo Electron Ltd.  
Panetron Division  
38 FL Shinjuku Nomura Bldg.  
1-26-2, Nishi-Shinjuku  
Shinjuku-ku, Tokyo 160  
Phone: 03-343-4411  
Telex: (781) 2322240 (LABTEL J)

## LIECHTENSTEIN

(See Switzerland)

## LUXEMBOURG

(See Germany)

## NETHERLANDS

Tekelec/Airtronic B. V.  
Stork Staat 7  
2722 NN Zoetermeer  
Phone: 079-310100  
Telex: (844) 33332 (TKLEC NL)

## NEW ZEALAND

Professional Electronics Ltd.  
126 Kitchener Road  
Milford, Auckland 9  
Phone: 46 94 50  
Telex: (791) 21084 (PROTON)

## NORWAY

Hefro Teknisk A/S  
Trondheimsveier 80  
Oslo 5  
Phone: 38 02 86  
Telex: (856) 16205 (HEFRO N)

## SINGAPORE

Rohm Electronics Co. Pte. Ltd.  
Unit G, Third Floor  
Cheng Chwee Huat Ind. Bldg.  
118-D, Paya Lebar Road  
Singapore 1440  
Phone: 2834327  
Telex: (786) 26648 (ROHM S)

## SOUTH AFRICA

South Continental Devices (Pty.) Ltd.  
Suite 516, 5th Floor, Randover House  
Cor. Hendrik Verwoerd, Dover Road  
Randburg, Transvaal  
Phone: 48 05 15  
Telex: (960) 4-24849 (SA)

## SPAIN

(Call Exar Direct)

## SWEDEN

Lagercrantz Electronix AB  
Kanalvagen 5  
S-194 01 Upplands Vasby  
Phone: (0760) 86 120  
Telex: (854) 11275 (LAGER S)

## SWITZERLAND

Amera Electronics AG  
Lerchenhaldenstrasse 73  
CH-8046 Zurich  
Phone: (01) 57 11 12  
Telex: (845) 59837 (AMERA CH)

## TAIWAN

(See Hong Kong)

## UNITED KINGDOM

Memec Ltd.  
Thame Park Ind. Estate  
Thame, Oxon OX9 3RS  
Phone: (084 421) 3146  
Telex: (851) 837508 (MEMEC G)

## LATIN AMERICA

Intectra  
2349 Charleston Road  
Mt. View, CA 94043 U.S.A.  
Phone: (415) 967-8818  
Telex: 345545 (INTECTRA MNTV)

## ALL OTHER COUNTRIES

(Call Exar Direct)

# AUTHORIZED STOCKING DISTRIBUTORS

## ALABAMA

Resisticap, Inc.  
Huntsville  
(205) 881-9270

## ARIZONA

Sterling Electronics  
Phoenix  
(602) 258-4531

## ARKANSAS

(See Oklahoma)

## CALIFORNIA

Anthem Electronics  
San Diego  
(714) 279-5200

Anthem Electronics  
San Jose  
(408) 946-8000

Anthem Electronics  
Tustin  
(714) 730-8000

Bell Industries  
Sunnyvale  
(408) 734-8570

JACO  
Chatsworth  
(213) 998-2200

VSI Electronics  
(USA) Inc.  
Santa Ana  
(213) 299-7760

Zeus West, Inc.  
Anaheim  
(714) 632-6880

## COLORADO

Bell Industries  
Wheatridge  
(303) 424-1985

Diplomat Electronics  
Denver  
(303) 427-5544

## CONNECTICUT

Diplomat Electronics  
Danbury  
(203) 797-9674

JV Electronics, Inc.  
East Haven  
(203) 469-2321

## DELAWARE

(See Pennsylvania)

## FLORIDA

Diplomat Southland  
Clearwater  
(813) 443-4514

Diplomat Southland  
Ft. Lauderdale  
(305) 971-7160

## FLORIDA (Continued)

Diplomat Southland  
Palm Bay  
(305) 725-4520

## GEORGIA

(See Florida)

## IDAHO

(See Washington)

## ILLINOIS

Diplomat Electronics  
Bensenville  
(312) 595-1000

R. M. Electronics  
Lombard  
(312) 932-5150

## INDIANA

Graham Electronics  
Indianapolis  
(317) 634-8202

R. M. Electronics  
Indianapolis  
(317) 247-9701

## IOWA

DEECO, Incorporated  
Cedar Rapids  
(319) 365-7551

## KANSAS

Component Specialties  
Lenexa  
(913) 492-3555

## KENTUCKY

(See Indiana)

## LOUISIANA

(See Texas)

## MAINE

(See New Hampshire)

## MARYLAND

Diplomat Electronics  
Columbia  
(301) 995-1226

Pioneer Electronics  
Gaithersburg  
(301) 948-0710

## MASSACHUSETTS

Diplomat Electronics  
Holliston  
(617) 429-4121

Gerber Electronics  
Norwood  
(617) 329-2400

RC Components  
Wilmington  
(617) 657-4310

## MICHIGAN

Camelot Electronics  
Livonia  
(313) 591-0055

Diplomat Electronics  
Farmington  
(313) 477-3200

R. M. Electronics  
Grand Rapids  
(616) 531-9300

## MINNESOTA

Diplomat Electronics  
Minneapolis  
(612) 788-8601

MISSISSIPPI  
(See Alabama)

## MISSOURI

Olive Industrial Elect.  
St. Louis  
(314) 426-4500

## MONTANA

(Call Exar Direct)

## NEVADA

(See California)

## NEW HAMPSHIRE

Yankee Electric Supply  
Manchester  
(603) 625-9746

## NEW JERSEY

Diplomat Electronics  
Mount Laurel  
(609) 234-8080

Diplomat Electronics  
Totowa  
(201) 785-1830

## NEW MEXICO

Bell Industries  
Albuquerque  
(505) 292-2700

## NEW YORK

Diplomat Electronics  
E. Syracuse  
(315) 437-9900

Diplomat Electronics  
Melville  
(516) 454-6400

JACO  
Hauppauge  
(516) 273-5500

Zeus Components, Inc.  
Elmsford  
(914) 592-4120

## NORTH CAROLINA

(See Maryland)

## NORTH DAKOTA

(Call Exar Direct)

## OHIO

Graham Electronics  
Cincinnati  
(513) 772-1661

## OKLAHOMA

Component Specialties  
Tulsa  
(918) 664-2820

## OREGON

Radio, Inc.  
Tulsa  
(918) 587-9123

Quality Components  
Tulsa  
(918) 664-8812

## OREGON

Radar Electric Co., Inc.  
Portland  
(503) 233-3691

## PENNSYLVANIA

Advacom  
Erie  
(814) 476-7774

Pioneer Electronics  
Horsham  
(215) 674-4000

## RHODE ISLAND

(See Massachusetts)

## SOUTH CAROLINA

(See Maryland)

## SOUTH DAKOTA

(Call Exar Direct)

## TENNESSEE

(See Alabama)

## TEXAS

Component Specialties  
Austin  
(512) 837-8922

Component Specialties  
Dallas  
(214) 357-6511

Component Specialties  
Houston  
(713) 771-7237

Quality Components  
Addison  
(214) 387-4949

Quality Components  
Austin  
(512) 835-0220

Quality Components  
Houston  
(713) 772-7100

## UTAH

Bell Industries  
Salt Lake City  
(801) 972-6969

Diplomat Electronics  
Salt Lake City  
(801) 486-4134

## VERMONT

(See New Hampshire)

## VIRGINIA

(See Maryland)

## WASHINGTON

Radar Electric Co., Inc.  
Seattle  
(206) 282-2511

Western Electromotive  
Seattle  
(206) 575-1910

## WISCONSIN

Taylor Electric Co.  
Mequon  
(414) 241-4321

## WYOMING

(See Colorado)

## CANADA

Future Electronics  
Montreal, Quebec  
(514) 731-7441

Intek Electronics Ltd.  
Vancouver, B.C.  
(604) 324-6831

R-A-E Industrial Elect.  
Burnaby, B.C.  
(604) 291-8866

Cam Gard Supply Ltd.  
Calgary, Alberta  
(403) 287-0520

Cam Gard Supply Ltd.  
Saskatoon,  
Saskatchewan  
(306) 652-6424

Cam Gard Supply Ltd.  
Toronto, Ontario  
(416) 252-5031

Cam Gard Supply Ltd.  
Vancouver, B. C.  
(604) 291-1441

Cam Gard Supply Ltd.  
Winnipeg, Manitoba  
(204) 786-8401



# AUTHORIZED REPRESENTATIVES

## ALABAMA

Rep, Incorporated  
11527 S. Memorial  
Parkway.  
Huntsville, AL 35803  
(205) 881-9270  
TWX 810-726-2102

## ALASKA

(Call Exar Direct)

## ARIZONA

Summit Sales  
7336 E. Shoeman Lane  
Suite 116E  
Scottsdale, AZ 85251  
(602) 994-4587  
TWX 910-950-1283

## ARKANSAS

(See Oklahoma)

## CALIFORNIA (NO.)

Criterion  
3350 Scott Blvd.,  
Bldg. 44  
Santa Clara, CA 95051  
(408) 988-6300  
TWX 910-338-7352

## CALIFORNIA (SO.)

Varigon Associates  
137 Eucalyptus Drive  
El Segundo, CA 90245  
(213) 322-1120  
TWX 910-348-7141

Varigon/ARC

2356 Moore St.,  
Suite 102  
San Diego, CA 92110  
(714) 299-5413

## COLORADO

Waugaman Assoc., Inc.  
4800 Van Gordon St.  
Wheatridge, CO 80033  
(303) 423-1020  
TWX 910-938-0750

## CONNECTICUT

Phoenix Sales  
389 Main Street  
Ridgefield, CT 06877  
(203) 438-9644  
TWX 710-467-0662

## DELAWARE

(See Maryland)

## FLORIDA

Donato & Assoc., Inc.  
2660 West Oakland  
Park Blvd.  
Suite 210  
Ft. Lauderdale, FL  
33311  
(305) 733-3450  
TWX 510-955-9789

## GEORGIA

Rep, Incorporated  
1944 Coolegge Road  
Tucker, GA 30084  
(404) 938-4358

## HAWAII

(Call Exar Direct)

## IDAHO

(See Washington)

## ILLINOIS (NORTH)

Janus, Incorporated  
3166 Des Plaines Ave.  
Suite 14  
Des Plaines, IL 60018  
(312) 298-9330

## ILLINOIS (SOUTH)

(See Missouri)

## INDIANA

(See Ohio)

## IOWA

Dytronix, Inc.  
23 Twixt Town Road  
NorthEast  
Suite 201  
Cedar Rapids, IA  
52402  
(319) 377-8275

## KANSAS

(See Missouri)

## KENTUCKY

(See Ohio)

## LOUISIANA

(See Texas)

## MAINE

(See Massachusetts)

## MARYLAND

Component Sales, Inc.  
3701 Old Court Rd.  
Suite 14  
Baltimore, MD 21208  
(301) 484-3647  
TWX 710-862-0852

## MASSACHUSETTS

Contact Sales, Inc.  
101 Cambridge Street  
Burlington, MA 01803  
(617) 273-1520  
TWX 710-332-6569

## MICHIGAN

(See Ohio)

## MINNESOTA

Dan'l Engineering  
12350 W. 175th St.  
Lakeville, MN 55044  
(612) 435-6000

## MISSISSIPPI

(See Alabama)

## MISSOURI

Dy-Tronix, Inc.  
11190 Natural Bridge  
Bridgeton, MO 63044  
(314) 731-5799  
TWX 910-762-0651

Dy-Tronix, Inc.

13700 E. 42nd Terrace  
Suite 202  
Independence, MO  
64055  
(816) 373-6600

## MONTANA

(See Colorado)

## NEBRASKA

(See Missouri)

## NEVADA

(See California No.)

## NEW HAMPSHIRE

(See Massachusetts)

## NEW MEXICO

Syntech  
302C San Pablo S.E.  
Albuquerque, NM  
87108  
(505) 266-7951

## NEW JERSEY (NO.)

(See New York City)

## NEW JERSEY (SO.)

(See Pennsylvania)

## NEW YORK (UPSTATE)

Quality Components  
2095 Kensington Ave  
Buffalo, NY 14226  
(716) 839-4170

Quality Components

116 E. Fayette St.  
Manlius, NY 13104  
(315) 682-8885  
TWX 710-545-0663

## NEW YORK (CITY)

ERA, Incorporated  
354 Veterans  
Memorial Hwy.  
Commack, NY 11725  
(516) 543-0510  
In NJ: 800-645-5500/1  
TWX 510-226-1485

## NORTH CAROLINA

Component Sales, Inc.  
P.O. Box 18821  
Raleigh, NC 27619  
(919) 782-8433  
TWX 510-928-0513

## NORTH DAKOTA

(See Minnesota)

## OHIO

McFadden Sales  
4645 Executive Drive  
Columbus, OH 43220  
(614) 459-1280  
TWX 810-482-1623

## OKLAHOMA

Technical Marketing  
9717 East 42nd St.  
Suite 210  
Tulsa, OK 74145  
(918) 622-5984

## OREGON

(See Washington)

## PENNSYLVANIA (WEST)

(See Ohio)

## PENNSYLVANIA (EAST)

Vantage Sales Company  
21 Bala Avenue  
Bala Cynwyd, PA 19004  
(215) 667-0990  
TWX 510-662-5846

## RHODE ISLAND

(See Massachusetts)

## SOUTH CAROLINA

(See North Carolina)

## SOUTH DAKOTA

(See Minnesota)

## TENNESSEE

Rep, Incorporated  
113 S. Branner Ave.  
Jefferson City, TN  
37760  
(615) 475-4105  
TWX 810-570-4203

## TEXAS

Technical Marketing  
9027 Northgate Blvd.  
Suite 140  
Austin, TX 78758  
(512) 835-0064

Technical Marketing  
3320 Wiley Post Road  
Carrollton, TX 75006  
(214) 387-3601  
TWX 910-860-5158

Technical Marketing  
6430 Hillcroft  
Suite 104  
Houston, TX 77081  
(713) 777-9228

## UTAH

SK Component Sales  
2520 S. State  
Salt Lake City, UT  
84115  
(801) 484-4222

## VERMONT

(See Massachusetts)

## VIRGINIA

(See Maryland)

## WASHINGTON

SD-R<sup>2</sup> Products & Sales  
14042 NE 8th Street  
Suite 201  
Bellevue, WA 98007  
(206) 747-9424  
TWX 910-443-2483

## WASHINGTON, D.C.

(See Maryland)

## WEST VIRGINIA

(See Ohio)

## WISCONSIN (S. EAST)

(See Illinois)

## WISCONSIN (WEST)

(See Minnesota)

## WYOMING

(See Colorado)

## CANADA (EAST)

R.F.Q. Limited  
385 The West Mall  
Suite 209  
Etobicoke, Ontario  
M9C 1E7  
(416) 626-1445  
TWX 610-492-2540

R.F.Q. Limited  
2249 Carling Avenue  
Suite 204  
Ottawa, Ontario  
K2B 7E9  
(613) 820-8445/8446  
TWX 610-562-1973



EXAR INTEGRATED SYSTEMS, INC.

750 Palomar Avenue, P.O. Box 62229, Sunnyvale, CA 94088

(408) 732-7970 TWX 910-339-9233

© November 1980