

# ACS-9910 Controller User Manual



**SCSI/FIBRE to SCSI Controller**

# ACS-9910 User Manual

Copyright 2004 Accusys, Inc. Version 2.0B

[Http://www.accusys.com.tw](http://www.accusys.com.tw)

# Preface

## Notice

Product features and specifications described in this manual are subject to change without notice.

The manufacturer shall not be liable for any damage, or for the loss of information resulting from the performance or use of the information contained herein.

## Trademarks

Accusys and the names of Accusys products and logos referenced herein are either trademarks and/or service marks or registered trademarks and/or service marks of Accusys, Inc.

Microsoft, Windows, Windows NT, MS-DOS are either trademarks or registered trademarks of Microsoft Corporation.

Intel and Pentium are registered trademarks of Intel Corporation.

Other product and company names mentioned herein may be trademarks and/or service marks of their respective owners.

All contents of this manual are copyrighted by Accusys, Inc.

The information contained herein is the exclusive property of Accusys, Inc. and shall not be copied, transferred, photocopied, translated on paper, film, electronic media, or computer-readable form, or otherwise reproduced in any way, without the express written permission of Accusys Inc.

© Copyright 2004 Accusys, Inc.

All rights reserved.

This manual version 2.0b

## Regulatory information



This drive is in conformity with the EMC directive.

### **Federal Communications Commission (FCC) Statement**

This equipment has been tested and found to comply with the limits for a Class B digital device, pursuant to part 15 of the FCC Rules.

Those limits are designed to provide reasonable protection against harmful interference in a residential installation. This equipment generates, uses and can radiate radio frequency energy and, if not installed and used in accordance with the instructions, may cause harmful interference to radio communications. However, there is no guarantee that interference will not occur in a particular installation. If this equipment does cause harmful interference to radio or television reception, which can be determined by turning the equipment off and on, the user is encouraged to try to correct the interference by one or more of the following measures:

- Reorient or relocate the receiving antennas.

- Increase the separation between the equipment and receiver.

- Connect the equipment into an outlet on a circlet different from that to which the receiver is connected.

- Consult the dealer or an experienced radio/TV technician for help.

### **Warning:**

A shielded-type power cord is required in order to meet FCC emission limits and also to prevent interference to the nearby radio and television reception. It is essential that only the supplied power cord be used.

Use only shielded cables to connect I/O devices to this equipment.

You are cautioned that changes or modifications not expressly approved by the party responsible for compliance could void your authority to operate the equipment.

## About this Manual

### Intended user

This manual is designed and written for users of the ACS-9910 RAID controller. The user should ideally be familiar with RAID planning and data storage operations and have experience in electronic or computer engineering.

### Organization of the manual

This manual consists of the following sections:

- Chapter 1: **Introduction** provides details of key features, checklists of package contents and user requirements, and an overview of the controller box and its features.
- Chapter 2: **Installation** guides you through process of installing DRAM in ACS-9910 and integrating the controller into a system. This chapter also details procedures for replacing components.
- Chapter 3: **Quick Setup** explains how to set up an array in seconds.
- Chapter 4: **Accessing the Monitor Utility** tells you how to access and start using the firmware-based Monitor Utility on the host terminal.
- Chapter 5: **Configuration** details and explains the rich configuration options available for ACS-9910 arrays, using either the control panel or Monitor Utility.
  
- Appendix A: **Troubleshooting** helps you deal with encountered problems in the form of Q&A.
- Appendix B: **Introduction to RAID levels** contains all the information you need to understand the features of different RAID levels.
- Appendix C: **Optional Components** contains instructions on installing daughterboards to augment your RAID controller's capabilities.
- Appendix D: **Control Panel Messages** defines the status and error messages of the control panel LCD display.
- Appendix E: **Glossary** defines relevant technical terms used in this manual.
- Appendix F: **Specifications** list technical specification of ACS-9910.
- Appendix G: **Contact Us** lists contact details of Accusys business units around the world.

## Using this manual

This guide contains all the information you need to set up and start using your RAID controller and to monitor its performance in real time. It is intended to be read in a linear manner, though some instructions may not be applicable to all users. Users may also prefer to skip more familiar sections, but each of the steps below must be completed.

The setup process will follow these steps:

### Step 1

- Prepare:**
- ◆ Familiarize yourself with the features and capabilities of ACS-9910 (**Chapter 1**)
  - ◆ Make sure you have everything (**Chapter 1**)

### Step 2

- Install:**
- ◆ Install SODIMM cache memory and attach the necessary cables (**Chapter 2**)
  - ◆ Turn on (**Chapter 2**)

### Step 3

- Configure:**
- ◆ Perform Quick Setup (**Chapter 3, optional**)
  - ◆ Open Monitor Utility (**Chapter 4, recommended**)
  - ◆ Configure (**Chapter 5**)

## Guide to conventions

Important information that users should be aware of is indicated with the following icons:



### Caution

*This icon indicates the existence of a potential hazard that could result in personal injury, damage to your equipment or loss of data if the safety instruction is not observed.*



### Note

*This icon indicates useful tips on getting the most from your RAID controller.*

Important terms, commands and programs are put in **Boldface** font.

Screen text is given in **screen** font.

## Related Documents for Reference

ACSView/AccuSet User's Manual: A guide to the GUI applications designed for use with Accusys 8 series and 9 series RAID controllers. The applications serve as handy and effective tools for remote, cross-platform monitoring and control of RAID Controllers.

## Related Products/Versions

The following supplementary hardware is NOT supplied in the package of the ACS-9910 RAID Controller. You may wish to purchase them as additional devices to boost the performance of the RAID Controller or for higher channel scalability.

1. SCSI daughter-board (ACS-7480)
2. Fibre daughter-board (ACS-7140)

# Table of Contents

<b>PREFACE</b> .....	<b>1</b>
NOTICE .....	1
TRADEMARKS .....	1
REGULATORY INFORMATION .....	2
ABOUT THIS MANUAL .....	3
<i>Intended user</i> .....	3
<i>Organization of the manual</i> .....	3
USING THIS MANUAL .....	4
GUIDE TO CONVENTIONS .....	5
RELATED DOCUMENTS FOR REFERENCE .....	5
RELATED PRODUCTS/VERSIONS .....	5
<b>CHAPTER 1 - INTRODUCTION</b> .....	<b>10</b>
OVERVIEW .....	10
KEY FEATURES .....	11
<i>Three Operating modes</i> .....	11
<i>Self-Diagnostic Mode</i> .....	11
<i>Configuration Mode</i> .....	12
<i>Operation Mode</i> .....	12
<i>Two Configuration Utilities</i> .....	12
<i>Supporting SCSI/Fibre Interface</i> .....	13
<i>Flexible Array Management</i> .....	13
<i>Hard Drive Hot Swapping</i> .....	13
<i>Automatic Global Hot Spare</i> .....	13
<i>Automatic Drive Rebuild</i> .....	13
<i>Instant Remote Notification</i> .....	13
<i>UPS Support</i> .....	13
BEFORE YOU BEGIN .....	14
<i>What's in the box</i> .....	14
<i>What else you need</i> .....	14
<i>What else you need</i> .....	14
FAMILIARIZING YOURSELF WITH THE RAID CONTROLLER .....	16
<i>Controller Box Overview</i> .....	16
<i>Control Panel</i> .....	16
<i>Rear View</i> .....	17



SUPPLIED ACCESSORIES.....	17
<i>3-in-1 Combo Cable</i> .....	17
<i>RS232 Connection for VT-100/ANSI Terminal-Emulation</i> .....	17
<i>Default Serial Port Settings</i> .....	18
<i>Modem Connection</i> .....	18
<i>UPS Connection</i> .....	18
<b>CHAPTER 2 - INSTALLATION.....</b>	<b>19</b>
INSTALLATION FLOWCHART .....	19
PRE-INSTALLATION NOTICES .....	20
INSTALLING / UPGRADING SODIMM .....	21
<i>SODIMM specifications:</i> .....	21
<i>Architecture of supported SODIMM:</i> .....	21
<i>Installing SODIMM</i> .....	22
<i>Removing SODIMM</i> .....	22
CHANGING COMPONENTS .....	22
<i>Removing / replacing control panel</i> .....	22
<i>Removing / replacing controller board and backplane</i> .....	23
CABLING .....	24
TURNING ON FOR THE FIRST TIME.....	26
TURNING OFF .....	26
RESTARTING.....	26
<b>CHAPTER 3 - QUICK SETUP .....</b>	<b>27</b>
QUICK SETUP WITH THE CONTROL PANEL .....	28
QUICK SETUP WITH THE MONITOR UTILITY .....	29
<b>CHAPTER 4 - ACCESSING THE MONITOR UTILITY .....</b>	<b>30</b>
ESTABLISHING A TERMINAL CONNECTION .....	30
USING THE MONITOR UTILITY .....	32
<i>Monitor utility control keys</i> .....	33
<i>Menu area controls</i> .....	33
<i>Output area controls</i> .....	33
<b>CHAPTER 5 - CONFIGURATION.....</b>	<b>34</b>
CONFIGURATION OVERVIEW .....	34
<i>System configuration</i> .....	34
<i>RAID configuration</i> .....	35
<i>How to configure ACS-9910</i> .....	36
FINDING YOUR WAY AROUND THE MENUS .....	37

ACCESSING THE MAIN MENU ..... 38

*Using the Monitor Utility*..... 38

*Using the Control Panel* ..... 39

SETTING SYSTEM PARAMETERS ..... 40

*Edit Chassis Menu* ..... 40

SETTING ARRAY PARAMETERS ..... 42

*Edit Array Menu* ..... 42

SETTING CONNECTION PARAMETERS ..... 44

*Edit Chan Menu* ..... 44

CHECKING CONFIGURATION ..... 46

*View Config Menu*..... 46

SETTING PORT PARAMETERS ..... 47

*RS232 Params Menu*..... 47

*Modem Port Menu* ..... 47

*Terminal Port Menu*..... 47

PASSWORD SECURITY ..... 48

*Password Info Menu* ..... 48

ENTERING AND EDITING ALERT SETTINGS ..... 49

*Pager alert settings*..... 49

*Pager Info Menu* ..... 50

FAX ALERT SETTINGS ..... 51

*Fax Info Menu*..... 51

*Company Info Menu*..... 52

MODEM SETTINGS ..... 52

*Modem Init St Menu*..... 52

SAVING CONFIGURATIONS ..... 53

*Save Config Menu*..... 53

RESTARTING THE CONTROLLER..... 53

*Restart Menu*..... 53

ADVANCED SETTINGS ..... 54

*Utility Menu* ..... 54

    A. *Utility*..... 54

UPDATING THE FIRMWARE..... 56

**APPENDIX A - TROUBLESHOOTING ..... 58**

**APPENDIX B - INTRODUCTION TO RAID LEVELS ..... 60**

    RAID 0 ..... 61

<i>RAID 1</i> .....	62
<i>RAID 0+1</i> .....	63
<i>RAID 3</i> .....	64
<i>RAID 5</i> .....	65
<b>APPENDIX C - OPTIONAL COMPONENTS</b> .....	<b>66</b>
SCSI DAUGHTERBOARD (ACS-7480) .....	66
FIBRE DAUGHTERBOARD (ACS-7140).....	66
REMOVING / REPLACING DAUGHTERBOARD .....	66
<b>APPENDIX D - CONTROL PANEL MESSAGES &amp; ALARMS</b> .....	<b>67</b>
<b>APPENDIX E - GLOSSARY</b> .....	<b>68</b>
<b>APPENDIX F - SPECIFICATIONS</b> .....	<b>70</b>
<b>APPENDIX G - CONTACT US</b> .....	<b>71</b>
ACCUSYS, INC. ....	71
ACCUSYS U.S.A., INC. ....	71
ACCUSYS GERMANY .....	71
ACCUSYS KOREA, INC.....	71
ACCUSYS CHINA, INC. ....	72

**Chapter 1****Introduction**

This chapter introduces the features and capabilities of ACS-9910. You will find:

- ⇒ A full introduction to your ACS-9910 RAID Controller
- ⇒ Details of key features and supplied accessories
- ⇒ A checklist of package contents
- ⇒ A checklist of what else you need to start installation

**Overview**

Congratulations on your selection of the Accusys 9910 (ACS-9910) RAID Controller— a powerful, Intel 80303 64 bit microprocessor-based, Ultra 160 SCSI RAID controller that delivers reliable, high-performance data protection to support mission critical business applications on mid and high-range RAID subsystems.

ACS-9910 is designed to meet today's demand for higher storage solutions. Ideally suited for integration with databases, e-mail, web servers and imaging systems, ACS-9910 provides maximum data protection and exceptional performance. ACS-9910 is designed for easy integration, smooth data expansion and server migration.

ACS-9910 is the ultimate flexible RAID solution. It can manage five different RAID levels, providing functions including

- Striping (RAID 0)
- Striping with Mirroring (RAID 0+1)
- Mirroring and Duplexing (RAID 1)
- Striping with Parity on Dedicated Disk (RAID 3)
- Striping with Interspersed Parity (RAID 5)

Your ACS-9910 RAID can be expanded and maintained without interruption (Hot swap/Hot Spare). Future expansion capabilities may become available through an optional daughter-board.

The ACS-9910 Controller Box features a user-friendly interface with LCD display for easy setup. Alternatively the RAID controller can also be customized from a remote VT-100 terminal (RS-232 interface). Initial configuration can be done in a matter of minutes.

Extra safety features include instant remote notification by an audible alarm, or by fax or pager, and the optional direct connection to a UPS device.

The ACS-9910 controller is the ideal solution for fast, reliable storage of large volumes of data.

## Key Features

ACS-9910 features the following:

- Support for RAID Levels 0, 1, 0+1, 3 and 5
- Independence from host system
- Independence from operating system
- Intel i80303 64-bit RISC High performance processor
- Supports Dual Ultra160 SCSI channel
- Superior Accusys Array Management Firmware
- Flexible cache size of up to 512MB
- Supports up to 16 logical units
- Supports on-line capacity expansion.
- Automatic Hot Swap, Hot Spare and Drive Rebuild Support
- Bad sector reassignment
- Programmable FAX event notification
- Remote monitoring through terminal
- UPS support through standard UPS interface
- Supporting SCSI/Fibre interface
- Flexible array management
- Hard drive hot swapping
- Automatic global hot spare
- Expandability enhanced by an optional daughter-board
- Automatic drive rebuild
- User-friendly LCD control panel
- Vt-100 terminal emulation
- Instant remote notification

### Three Operating modes

ACS-9910 operates in three modes: Self-Diagnostic Mode, Configuration Mode and Operation Mode.

#### Self-Diagnostic Mode

To ensure flawless operation, ACS-9910 has a built-in self-diagnostic utility. Self-diagnostic Mode is entered automatically upon power up, or after the ACS-9910 has been reset. In this mode, all components are tested, and any potential problems are reported. Once the tests are complete, ACS-9910 switches automatically to Operation Mode.

Self-Diagnostic Mode runs three major tests. The first diagnostic test covers the CPU and supporting core logic chips, the internal bus, memory, SCSI controller, enhanced IDE controllers, and RS-232 controllers. The second diagnostic test checks for the presence of disks on each individual disk channel and the functionality of each disk found. The final diagnostic test checks RAID functionality.

## Configuration Mode

Configuration Mode enables the RAID administrator to configure and modify the settings of ACS-9910 and fine-tune the configuration. Configuration Mode is entered from Operation Mode:

1. When the Enter button on the controller box is pressed
2. When the Monitor Utility is invoked from the remote terminal.



### Caution

*ACS-9910 should be off-line and not being accessed by any application when Configuration Mode is run.*



### Note

*ACS-9910 will automatically switch from Configuration Mode to Operation Mode after 3 minutes if no buttons are pressed on the controller box control panel and no action is taken on the Monitor Utility*

Full details on changing configurations are given in Chapter 5

## Operation Mode

Operation Mode is the default state of ACS-9910. In this mode, the controller box front panel LCD continuously displays the current status of ACS-9910. A full explanation of control panel LCD messages is given in Appendix C.

## Two Configuration Utilities

There are two ways to configure ACS-9910, namely using the LCD Control Panel and through terminal emulation.

### ***User-Friendly LCD Control Panel***

ACS-9910 can be configured directly using the LCD control panel.

### ***VT-100 Terminal Emulation (HyperTerminal)***

This embedded menu-based configuration utility is accessed through the host computer terminal.

## Supporting SCSI/Fibre Interface

ACS-9910 supports SCSI and Fibre interface. A supplementary connecting device (daughter-board) is required for Fibre connection. See **Appendix A, Installing/Removing Daughter-board** for details.

## Flexible Array Management

The unique ACS-9910 array management firmware utilizes multitasking real-time kernel technology to manage the controller. Additional features are real-time I/O load analysis, on-line diagnostics, event logging and broadcasting, and device inventory management. These features can be accessed locally or via modem to allow centralized monitoring and control of the ACS-9910.

## Hard Drive Hot Swapping

Hot Swapping allows for the removal and installation of disk drives without interruption of data access while the ACS-9910 system is in use. This is usually performed when there is no Hot Spare drive configured. There is no need to power down the system.

## Automatic Global Hot Spare

Hot Spare allows for the automatic replacement of a failed drive without requiring intervention from the administrator. When a disk fails the ACS-9910 will automatically replace the faulty drive with the configured hot spare disk.

The Global Spare Drive does not serve only a specified logical drive. When a member drive from any of the logical drives fails, the Global Spare Drive will join that logical drive and automatically start to rebuild.

## Automatic Drive Rebuild

If a member drive in a logical drive fails, the controller will first check whether there is a **Local Spare Drive** assigned to this logical drive. If yes, it will automatically start to rebuild.

If there is no Local Spare Drive available, the controller will search for a **Global Spare Drive**. If there is a Global Spare Drive, it will automatically rebuild the logical drive.

If neither Local Spare Drive nor Global Spare Drive is available, the controller will not try to rebuild unless the user applies a manual forced-rebuild.

## Instant Remote Notification

ACS-9910 supports but does not require additional software for system monitoring and analysis. The ACS-9910 array management firmware continuously monitors the system activity and immediately launches the fax event notification feature if any failure occurs. Up to two pager numbers and two fax numbers can be notified instantaneously and repeatedly for extra assurance.

## UPS Support

ACS-9910 supports the use of an uninterruptible power supply. In the event of a power breakdown, a UPS will keep the RAID controller online long enough for its internal cache memory to be saved to a hard drive.

## Before you begin

### What's in the box

Some vendors may ship certain components as standard, while other vendors treat the same component as optional. In its most basic configuration, your package should include the following:

- ACS-9910 Controller Box ×1
- ACS-9910 Controller User's Manual ×1
- 3-in-1 Combo Cable ×1
- 10-pin to 9-pin D-sub male Interface Cable
- Mounting screws (bag) ×1

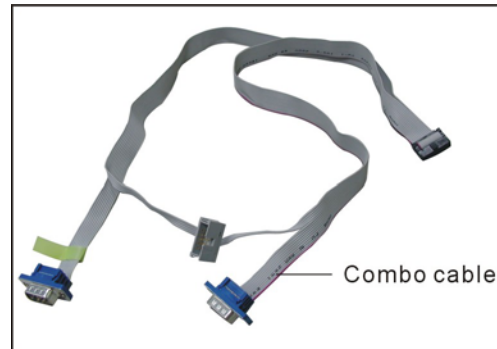

The following item(s) is (are) normally **optional**, but some vendors may choose to include them in the basic package:

- SO DIMM Memory Module



### Caution

*For non-proprietary accessories, such as memory modules, cables, etc., your vendor may be able to recommend compatible and reliable brands.*

## What else you need

### What else you need

- SCSI hard disk drives: Different RAID levels requires different numbers of HDDs. Turn to Appendix B to determine how many HDDs you require.
- Disk array enclosure: The proper enclosure should be able to accommodate the SCSI drives, a power supply, and at least one 5¼" half-height device, i.e. the ACS-9910 controller box.
- SCSI cables (and terminators unless ACS-9910 device termination is enabled).
- Dedicated VT-100™ Compatible terminal (or PC with third party communication software that supports ANSI terminal emulation) and Null Modem Cable: Required for viewing Monitor Utility.
- External power connector (same connector as for HDDs).
- Static grounding strap or electrostatic discharge (ESD) safe work area.
- External power connector (same as a HDD).
- Host computer with SCSI card interface
- Host computer with Fibre interface (optional; Fibre to SCSI configuration).
- Fibre cable with two 3-pin PTP connectors (optional; Fibre to IDE configuration only).





**Note**

*The hard drives in a RAID should match in size and speed. All drives in any array should be identical models with the same firmware versions. RAIDs can use any size drive, however the smallest drive will determine the size of the array.*



**Note**

*There is no set formula to determine how much cache memory to use, but as a general rule, a workstation, with mostly very large files, such as for audio or video editing and playback, graphics or CAD files, can benefit from a large cache. File servers, with multiple random access of varying file size, generally have little or no performance improvement with additional cache.*



**Note**

*ACS-9910 disk arrays do not require the installation of different drivers for use with different operating systems. ACS-9910 is independent and transparent to the host operating system.*

## Familiarizing Yourself with the RAID Controller

### Controller Box Overview

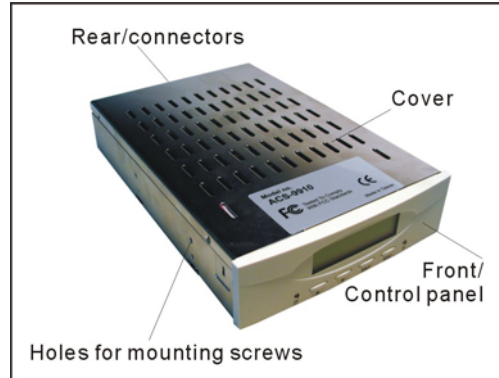

### Control Panel

The two-line, 16-character **LCD** displays the status and configuration information for ACS-9910.

The **Scroll buttons** are used to scroll through screens and highlight menu items

The **Enter button** is used to select an option

The **Escape button** is used to cancel a selection or return to the previous menu

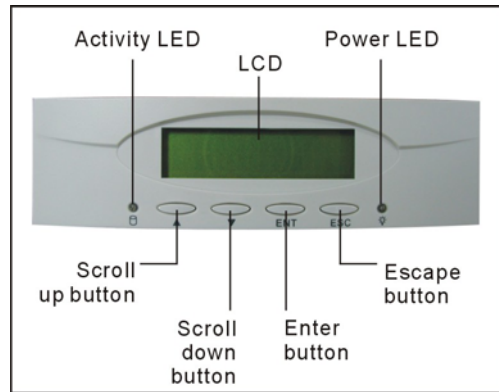

The **Power LED** lights solid when power is on

The **Activity LED** indicates that the RAID is being accessed:

Activity LED status	Controller status
▪ Flashing	▪ Data being accessed
▪ Solid	▪ Unprocessed data still cached in memory
▪ Unlit	▪ No activity

Full details on configuring with the control panel are given in Chapter 5.

A full list of LCD display messages is given in Appendix C

## Rear View

All ports are located on the rear panel of the controller.

There are four **SCSI connectors**, allowing the controller to be set up with two hosts and two disk channels, or a single host and three disk channels.

The **Hot Plug connector** is for optional connection to a hard disk backplane.

The **Combo connector** is for the insertion of the combo cable introduced below.

The **Power connector** fits a standard hard drive power cable head.

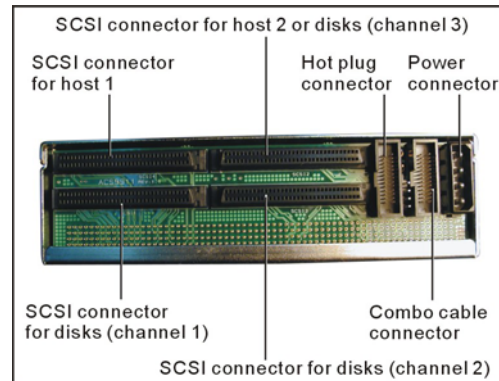

## Supplied accessories

### 3-in-1 Combo Cable

The combo cable includes the following connectors:

- An RS232 connector to link to the host terminal COM port enabling use of the monitor utility
- A modem connector enabling the automatic dispatch of alert faxes
- A monitor connector enabling various monitoring facilities. The default pin assignments are:

Pins 1+3: Fan failure

Pins 2+4: Temperature failure

Pins 5+7: Power source failure

Pins 6+8: UPS warning

Pins 9 and A are unassigned

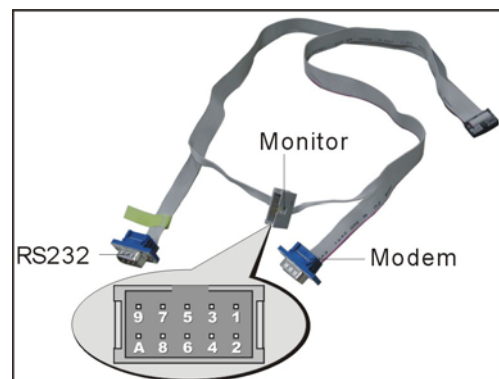

### RS232 Connection for VT-100/ANSI Terminal-Emulation

The ACS-9910 controller can be configured via a PC running a VT-100 or ANSI terminal-emulation. In order to connect to a PC, you need to connect an additional interface cable to the extension cable, which converts the RS-232 signal of the 10-pin header connector into a 9-pin D-sub male connector. The pin-layout of the 9-pin D-sub male connector is similar to that of a PC's serial power and is set as a DTE device.

## Default Serial Port Settings

Property	Default
Baud Rate (bps)	19200
Stop Bit	1
Data Bit	8
Parity	None

The baud rate can be changed using the interface on front panel.

## Modem Connection

ACS-9910 can be connected to a modem to allow remote notification in the event of an error. If a modem is properly connected to the modem header of the extension cable, you can configure the ACS-9910 to notify the administrator in case of malfunction. Supported notification devices are fax and pager.

## UPS Connection

The ACS-9910 controller can be connected to a UPS (Uninterrupted Power Supply) device for additional power supply security. In the event of any power failure on the main power connector, the UPS will take over and assure sustained operation for a certain period of time.



### Note

*A UPS connected to the ACS-9910 will keep the controller box running. You still need to ensure that the system of which the ACS-9910 also has a separate sufficient backup power solution. In order to protect the continuous operation of the ACS-9910 and all disks connected, you need to ensure that the power supplied by the UPS suffices the demand. Check your UPS vendor for more information.*

## Chapter 2

# Installation

---

**This chapter presents:**

- ⇒ Instructions on how to install and remove components and DRAM
- ⇒ Instructions on cabling and termination

## Installation flowchart

Installation of ACS-9910 is simple. This chapter will lead you through the following steps:

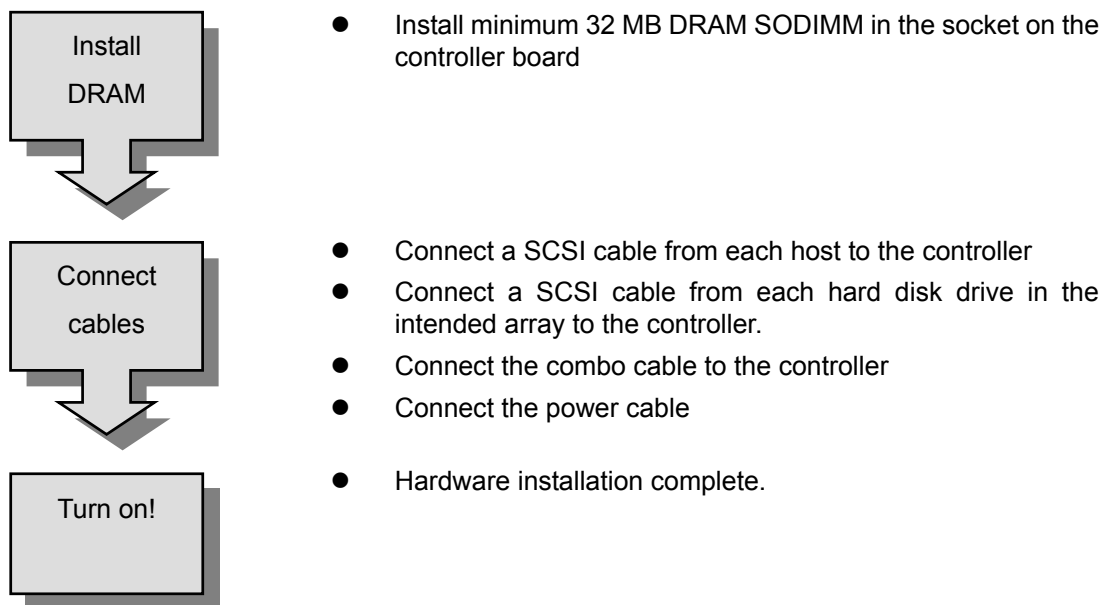

## Pre-installation notices



### Caution

*Before starting any kind of hardware installation, please ensure that all power switches have been turned off and all power cords disconnected to prevent personal injury and damage to the hardware*



### Caution

*To avoid overheating, ACS-9910 should be installed in a well-ventilated area and in such a way that sufficient airflow is maintained across the controller chips.*



### Caution

*Static electricity can damage electronic components. To guard against such damage:*

*Work in a static-free environment*

*Wear a grounded anti-static wrist strap*

*Store uninstalled components in anti-static bags*

*Handle PCBs by their edges and avoid touching chips and connectors.*



### Caution

*Environmental requirements    Temperature: 5°C to 45°C (41°F to 113°F)*

*Humidity: 10-95%, non-condensing*

*Altitude: Sea level to 10,000 ft*

## Installing / Upgrading SODIMM



### Caution

*Read the pre-installation notices earlier in this chapter before proceeding with installation.*

ACS-9910 is normally supplied without any DRAM installed. The ACS-9910 controller requires a minimum 32 MB DRAM SODIMM installed in the socket on the controller board in order to operate.



### Note

*There's no set formula to determine how much cache memory to use, but as a general rule, a workstation, with mostly very large files, such as for audio or video editing and playback, graphics or CAD files, can benefit from a large cache. File servers, with multiple random access of varying file size, generally have little or no performance improvement with additional cache.*

### SODIMM specifications:

Minimum	Recommended
<ul style="list-style-type: none"> <li>144-pin SDRAM SODIMM module (PC-100, 60~80 ns).</li> </ul>	<ul style="list-style-type: none"> <li>SDRAM</li> </ul>
<ul style="list-style-type: none"> <li>SODIMM, with or without parity</li> </ul>	<ul style="list-style-type: none"> <li>With parity, for security</li> </ul>
<ul style="list-style-type: none"> <li>Minimum of one SODIMM with 32 MB. The memory card socket can support 32, 64, 128, 256 or 512 MB of memory.</li> </ul>	<ul style="list-style-type: none"> <li>Minimum of 32 MB. More memory (up to 512MB) equals better performance: the size of the memory module defines the cache writing space available to the ACS-9910.</li> </ul>

### Architecture of supported SODIMM:

SDRAM Architecture	
<ul style="list-style-type: none"> <li>512 MB</li> </ul>	<ul style="list-style-type: none"> <li>16 (32M x 8)</li> </ul>
<ul style="list-style-type: none"> <li>256 MB</li> </ul>	<ul style="list-style-type: none"> <li>16 (16M x 8), 8 (32M x 8) <b>or</b></li> <li>8 (16M x 16)</li> </ul>
<ul style="list-style-type: none"> <li>128 MB</li> </ul>	<ul style="list-style-type: none"> <li>16 (8M x 8), 8 (16M x 8), 8 (8M x 16) <b>or</b></li> <li>4 (16M x 16)</li> </ul>
<ul style="list-style-type: none"> <li>64 MB</li> </ul>	<ul style="list-style-type: none"> <li>8 (8M x 8), 8 (4M x 16) <b>or</b></li> <li>4 (8M x 16)</li> </ul>
<ul style="list-style-type: none"> <li>32 MB</li> </ul>	<ul style="list-style-type: none"> <li>4 (4M x 16)</li> </ul>

## Installing SODIMM

To install a SODIMM, ensure the system power is off and disconnected. Then:

1. Remove any screws securing the controller box cover, then slide the cover back and lift off.
2. Remove the daughter board (if any has been installed).
3. Insert a memory card at a 45-degree angle into the memory card socket so that the gold teeth of the card are no longer visible.
4. Press the card down firmly until the latches lock it into place.

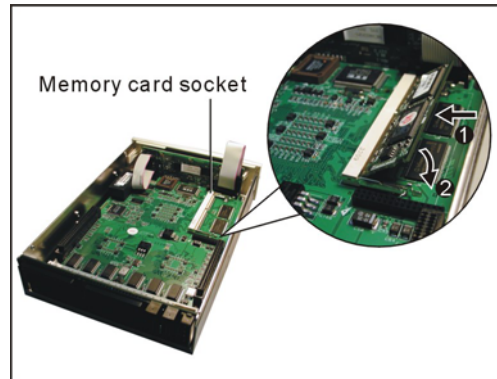

## Removing SODIMM

1. Remove the daughter board (if any has been installed).
2. Release the latches securing the SODIMM to the controller board. The SODIMM will pop up.
3. Lift the SODIMM gently out of the memory card socket.

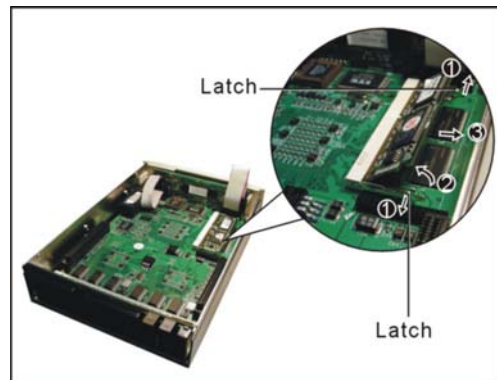

## Changing Components

### Removing / replacing control panel

To **remove** the control panel:

1. Remove the daughter board (if any has been installed).
2. Release the two control panel cables from the control panel.
3. Release the two latches securing the control panel to the controller box casing.
4. Ease the control panel forward out of the controller box.

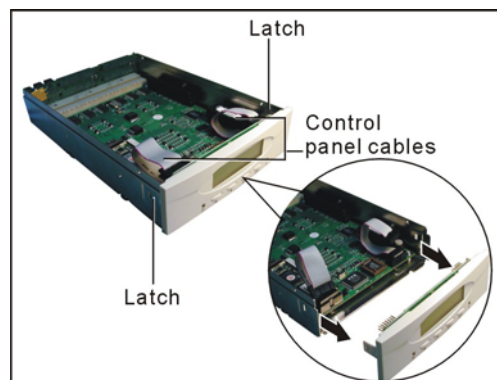

To **install** the control panel:

1. Connect the two control panel cables to the control panel.
2. Slot the control panel into position, ensuring that the two latches lock the control panel into position on the controller box casing.



## Removing / replacing controller board and backplane

To **remove** the controller board and backplane:

1. Remove the daughter board (if any has been installed).
2. Remove the control panel.
3. Remove four screws securing the controller board to the controller box casing.

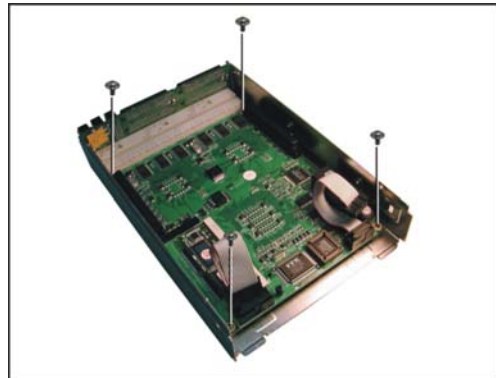

4. Ease the controller and backplane out of the controller box casing.

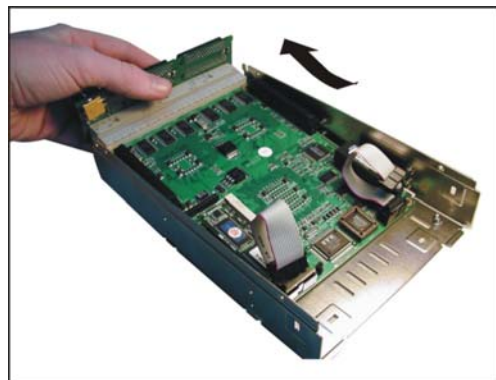

5. Detach the controller board and backplane

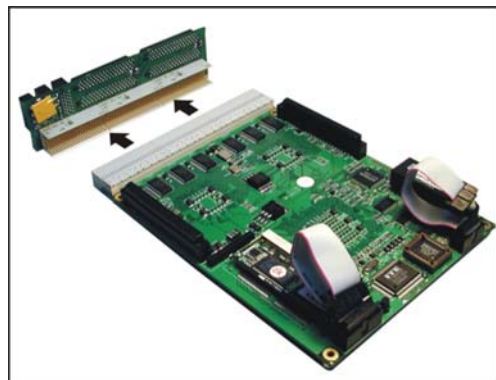

To **install** the controller board and backplane:

1. Align the controller board gold teeth connectors with the backplane connector and push together firmly, so that the gold teeth are no longer visible.
2. Slide the controller board into the controller box and ease the backplane into the correct position.
3. Secure the controller board with four screws.
4. Ensure a SODIMM is installed in the slot on the controller board.
5. Reinstall the control panel.
6. Reinstall the daughter board.

## Cabling

In its basic configuration (without the addition of an optional daughterboard), ACS-9910 supports up to four SCSI channels (the location of connectors for each channel is shown in the **Rear View** section of Chapter 1). Each controller channel supports up to 15 device drives. When planning the cable requirements, keep in mind basic SCSI rules regarding bus termination and maximum cable length, in order to avoid performance problems.



### Caution

*Read the pre-installation notices earlier in this chapter before proceeding with cabling.*



### Note

*The hard drives in a RAID should match in size and speed. All drives in any array should be identical models with the same firmware versions. RAID's can use any size drive, however the smallest drive will determine the size of the array.*

*Enable/disable term power on each drive, depending on the drive characteristics.*

*Set a unique SCSI ID address on each drive*

*Each channel controller reserves SCSI ID 7 by default.*

*If you install a terminator on a SCSI bus, you should disable SCSI termination by the controller using the control panel or Monitor Utility.*

1. Connect a SCSI cable from each hard disk drive in the intended array to a disk SCSI connector on the backplane.

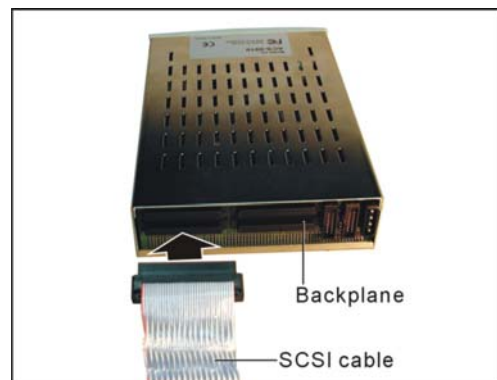

2. Connect a SCSI cable from the host system SCSI card to the SCSI host connector on the backplane.

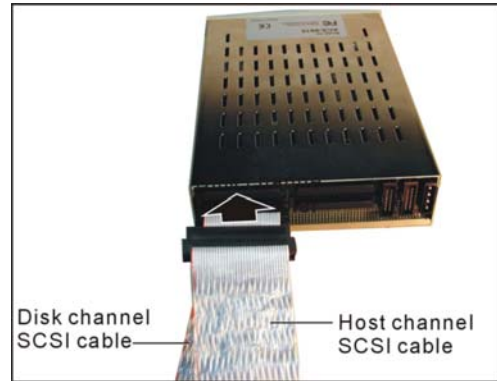

3. Connect the combo cable to the connector on the backplane. The notch on the combo cable connector should be aligned with the corresponding slot on the backplane connector to ensure correct insertion.

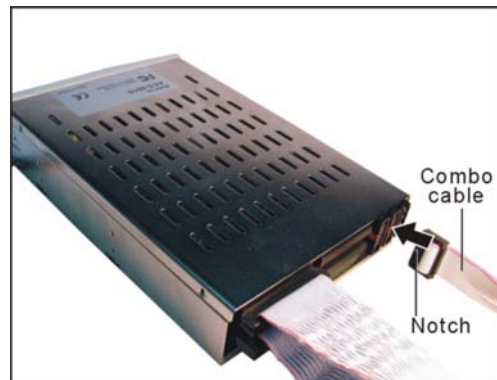

**Note**

*The combo cable provides a variety of monitoring options:*

- ⇒ *The RS232 cable is required for the use of the Monitor Utility*
- ⇒ *The modem connector enables the automatic dispatch of alert faxes*
- ⇒ *The monitor connector enables simultaneous monitoring of a subsystem fan, temperature gauge and UPS (uninterruptible power source)*

*See **Supplied accessories** in Chapter 1 for more on the combo cable.*

4. Connect a power cable to the connector on the backplane. The power input connector is identical to a standard hard drive power connector.

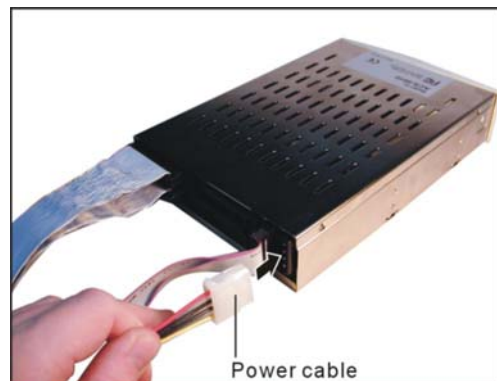

## Turning on for the first time

When cabling is complete, ACS-9910 can be turned on. This should be done in the following order:

1. First turn on the power source
2. Then boot the host computer(s)

When ACS-9910 is running, you are ready to configure one or more arrays. You have the following options:

1. Turn to Chapter 3 to perform a quick setup of a single RAID using the control panel.
2. Turn to Chapter 4 to access the Monitor Utility. Once the Monitor Utility is accessed, you can perform a Quick Setup (Chapter 3) or complete configuration (Chapter 5) with either the control panel or Monitor Utility.

Turn to Chapter 5 to perform a full configuration using the control panel.

## Turning off

When turning off ACS-9910, users are advised to first shut down the server, then power off ACS-9910.

## Restarting

When restarting ACS-9910, users are advised to first restart the server, then power on ACS-9910.

## Chapter 3

# Quick setup

Once ACS-9910 is set up and connected, the array should be initialized. The initialization process is automatic.

By performing Quick Setup, users can establish an array in seconds. There are two ways to perform Quick Setup:

- ⇒ Using the control panel
- ⇒ Using the embedded Monitor Utility

Both methods are explained in this chapter.

Quick Setup can be performed using the control panel of Monitor Utility. The control panel can be accessed immediately, so Quick Setup can be completed very quickly using this method. Use of the Monitor Utility requires a connection to be established first between the host terminal (which should have third party communication software supporting ANSI terminal emulation) and ACS-9910. Alternatively, the Monitor Utility can be accessed from a dedicated ANSI terminal.



### Note

*Quick Setup can only be used to establish a single array. To establish a multiple array, turn to Chapter 5.*



### Note

*Quick Setup cannot be used to reconfigure an existing array. To do this, turn to Chapter 5.*



### Note

*Ensure the required number of disks for all arrays is connected before configuring an array. RAID Level 3 and 5 require a minimum of 3 disks, RAID Level 1 a minimum of 2 disks, RAID Level 0 a minimum of 1 disk, and RAID 0+1 a minimum of 4 disks.*

## Quick Setup with the control panel

1. Turn on ACS-9910. The controller will enter self-diagnostic mode and automatically enter Operation Mode. A typical operation mode screen is shown.

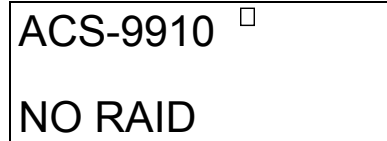

### Note

*Full explanation of the control panel messages is given in Appendix C.*

*Instructions on using the control panel are given in the section **Control Panel** in Chapter 1*

2. Press **Enter** to enter configuration mode. You will be prompted to enter the Password. The default password is **00000000** (eight zeros). To enter this, simply press **Enter** eight times. Press **Enter** again to submit.
3. You enter the Main Menu. The first item on the main menu is the Edit Chassis submenu. Scroll down to the second item in the Main Menu: Quick Setup. Press **Enter** to select.

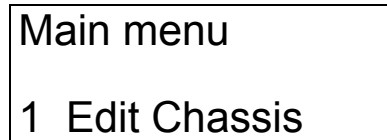

### Note

*The contents of all submenus other than Quick Setup are explained in detail in Chapter 5.*

*Full explanation of the different RAID levels available is given in Appendix B.*

*Quick Setup cannot be used to set up more than one array.*

4. The Quick Setup submenu lists the RAID levels available (0, 1, 3, 5 and 0+1). Scroll through the list until the appropriate RAID level for the array you want to set up is showing. Press **Enter**.
5. You will be prompted to select the number of disks for inclusion in the RAID. The minimum number of disks for that level array will be shown.
6. Finally, you will be prompted to confirm your choice. Select **Yes** and press **Enter** to complete Quick Setup.

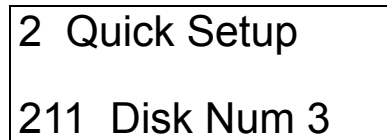
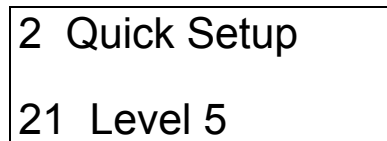

## Quick Setup with the Monitor Utility



### Note

*This section is intended as a Quick Setup guide only. Full instructions on accessing and using the Monitor Utility are given in Chapter 4.*

Users wishing to perform Quick Setup via the monitor utility must first establish a connection between the host terminal and ACS-9910. Follow the instructions in Chapter 5, *Accessing the Monitor Utility*. Then:

1. Press **Ctrl** and **D** together to launch the Monitor Utility.
2. Press **Enter**. You will be prompted to enter a password.
3. Enter the Default Password **00000000** (eight zeros. Press **Enter**.
4. The Main Menu will appear.
5. Use the arrow keys to select **2 Quick Setup**. Press **Enter**.
6. The Quick Setup submenu lists the RAID levels available (0, 1, 3, 5 and 0+1). Scroll through the list until the appropriate RAID level for the array you want to set up is highlighted. Press **Enter**.
7. You will be prompted to select the number of disks for inclusion in the RAID. The minimum number of disks for that level array will be shown.
8. Finally, you will be prompted to confirm your choice. Select **Yes** and press **Enter** to complete Quick Setup.



### Note

*The contents of all submenus other than Quick Setup are explained in detail in Chapter 5.*

*Full explanation of the different RAID levels available is given in Appendix B.*

*Quick Setup cannot be used to set up more than one array.*

## Chapter 4

# Accessing the Monitor Utility

Configuration of ACS-9910 can be accomplished using either the control panel or the embedded Monitor Utility, a convenient menu-based configuration utility, which is accessed through a dedicated terminal or host computer.

This chapter explains how to establish a connection between ACS-9910 and the host computer so that the Monitor Utility can be used. If you do not intend to access the Monitor Utility, this chapter can be ignored.

## Establishing a terminal connection

The Monitor Utility can be accessed from a dedicated terminal or a host PC with third party communication software that supports ANSI terminal emulation.

To use a dedicated terminal, simply connect the terminal to the RS232 head of the RAID controller's combo cable.

To access the Monitor Utility from a host PC, ensure that the RS232 head of the RAID controller's combo cable is attached to the host computer's COM port. A connection must then be established between the host computer and the ACS-9910 RAID controller. This is done by means of a terminal program, such as HyperTerminal. This section outlines the process to set up a HyperTerminal connection.

Other terminal programs may be used in place of HyperTerminal to communicate with the RAID controller. However, the setup process for other terminal software may differ from that outlined in this chapter.



### Note

*HyperTerminal is bundled as standard with Microsoft Windows operating systems. It will be found in the Communications folder. The program can also be downloaded from Hilgraeve Software at <http://www.hilgraeve.com/hpte/>*



1. Launch HyperTerminal from the desktop of the host computer (**Start > Programs > Accessories > Communications > HyperTerminal**).



2. The **Connection Description** dialog box will appear (if this is the first time you have run HyperTerminal, you will first be prompted to enter information about your location). Enter a name to identify the RAID controller connection (e.g. **Accusys** or **9910**) and select an icon to represent the connection. Press **OK**.

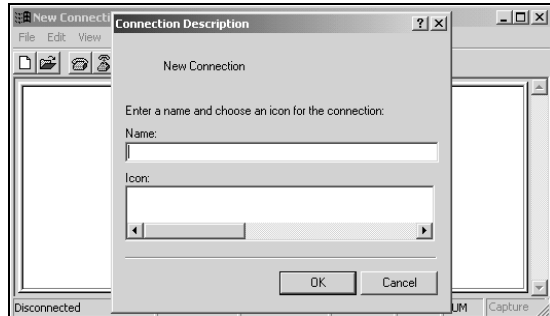

3. The **Connect to** dialog box appears. Select **COM1** or **COM2** from the **Connect using:** dropdown menu, depending on which port is linked to ACS-9910. Click **OK**.

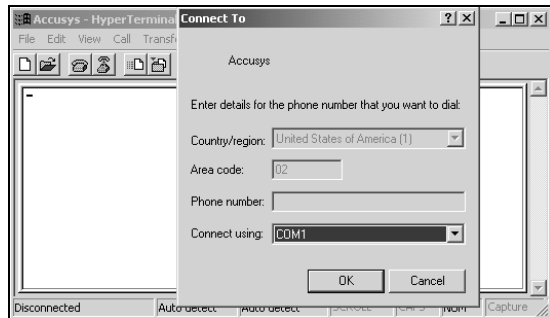

4. The **COM Properties** dialog box will appear. Set the following values:  
 Bits per second: 19,200  
 Data bits: 8  
 Parity: None  
 Stop bits: 1  
 Flow Control: Xon/Xoff

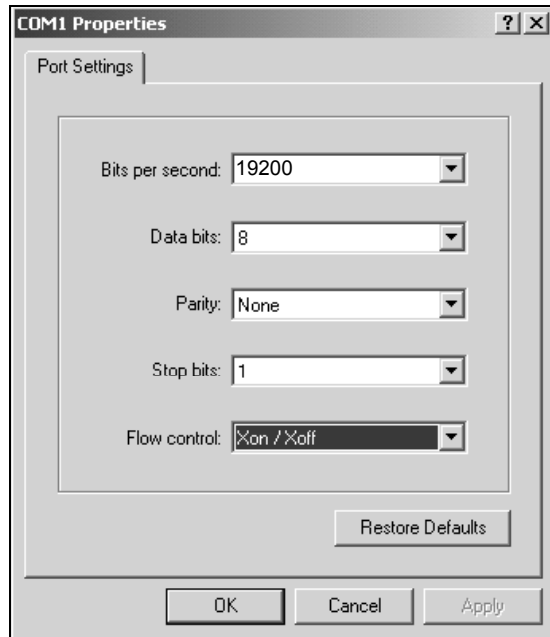

5. Click **OK**. The HyperTerminal connection to ACS-9910 is now established.

## Using the Monitor Utility

Once a connection has been set up between ACS-9910 and the host computer:

1. Make sure ACS-9910 is turned on
2. Press the Ctrl and D keys together to launch the Monitor Utility.



### Note

To enlarge the size of the Monitor Utility window in *HyperTerminal*, select **Font...** from the **View** menu and increase the font size.

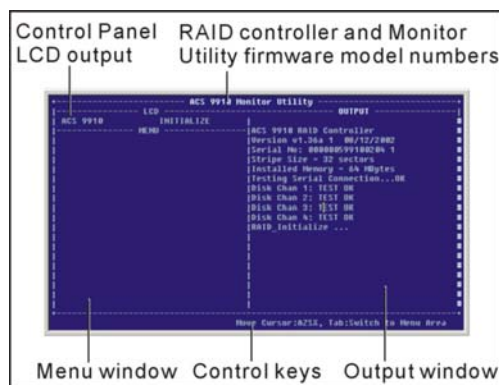

The Monitor Utility has four sections:

The **Top Bar** lists the RAID controller model number and the firmware (Monitor Utility) model number.

The **Control Panel LCD Output** panel mirrors the appearance of the controller box LCD. Full explanation of LCD messages is given in Appendix C.

The **Menu window** is the space into which menus are called up. Full instructions on navigating through the menus are given in Chapter 4.

The **Output window** displays the current status of the RAID controller and arrays.

The **Control keys** enable the user to navigate through and between the output and menu areas.

### Monitor utility control keys

The monitor utility control keys differ depending on which area is active: Menu area or Output area. The control keys are listed at the bottom of the Monitor Utility screen.

#### Menu area controls

- A Move cursor up
- Z Move cursor down
- Esc Cancel a selection / return to previous menu
- Enter Select an option
- Tab Switch to Output area

#### Output area controls

- A Move cursor up
- Z Move cursor down
- S Scroll to top of output list
- X Scroll to bottom of output list
- Tab Switch to Output area



#### Note

*The Monitor Utility and control panel cannot be used at the same time.*

## Chapter 5

# Configuration

This chapter explains how to access and implement the complete suite of ACS-9910 configuration options using either the Monitor Utility or control panel. It contains:

- ⇒ An outline of the configuration process
- ⇒ An explanation of the configuration menu structure
- ⇒ Instructions on accessing the configuration menus
- ⇒ Diagrams of menu options
- ⇒ Explanations of menu options
- ⇒ Instructions on how to update the ACS-9910 firmware

## Configuration overview

There are two aspects to configuration:

- Configuration of the RAID system and communication parameters
- Setting up and configuration of arrays within the RAID system

Users are advised to attend first to the system, then to the arrays.

### System configuration

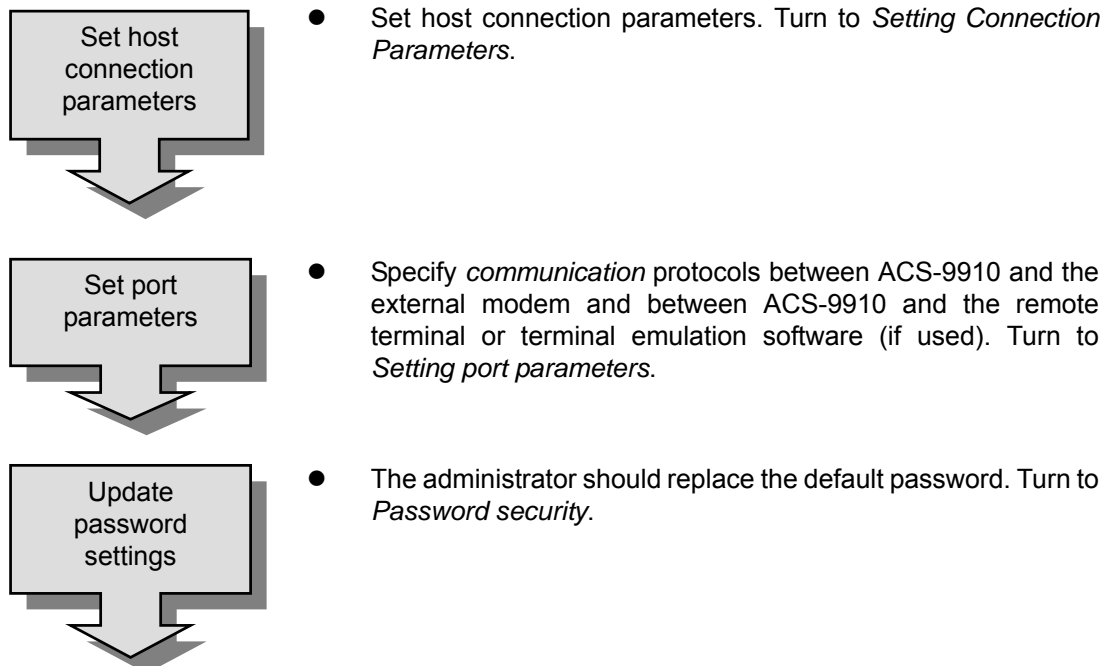

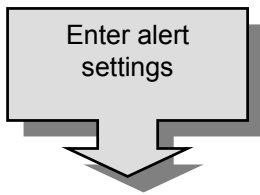

- The administrator can specify up to two fax numbers and two pager numbers to which alert messages will be sent in the event of an error with ACS-9910. Turn to *Entering and editing alert settings*.

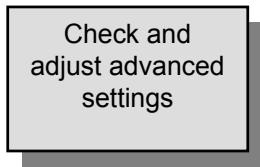

- The default settings are appropriate for most users. Turn to *Advanced settings*. Then proceed with RAID configuration.

### RAID configuration

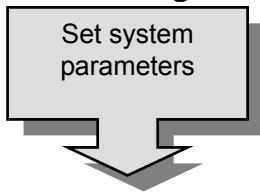

- Turn to *Setting system parameters* and define:
  - The number of hosts
  - The number of active slots (hard disks)
  - Striping block size
  - The plug mode

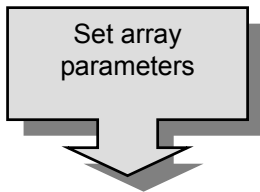

- Turn to *Setting array parameters* and set the following individual parameters for each array:
  - RAID level
  - Number of disks
  - Number and size of slices
  - Write buffer (enable/disable)
- The Setting array parameters section is where to turn to delete, reconfigure or set new array parameters

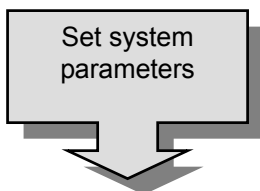

- Set the following parameters for the RAID system:
  - Striping block size
  - Write buffer (enable/disable)
  - Writing method (Random / sequential)

## LUN mapping

- Turn to *Setting connection parameters* and map each slice to a LUN

**Note**

*The Quick Setup option provides a convenient and rapid way to set up a simple array. See Chapter 3.*

**How to configure ACS-9910**

There are two ways to configure ACS-9910:

- Using the Control Panel
- Using the Monitor Utility

These two methods are functionally identical. Only the interface differs. In each, the user scrolls through menus and submenus to locate and select the desired configuration option.

**Note**

*For instructions on navigating through menus using the control panel, turn to the section **Control Panel** in Chapter 1.*

**Note**

*A full list of Control Panel LCD messages is given in Appendix C.*

**Note**

*For instructions on using the Monitor Utility, turn to the section **Using the Monitor Utility** in Chapter 4.*

**Note**

*The control panel cannot be used in configuration mode while a Monitor Utility connection is running. If you wish to configure using the control panel, first exit the remote terminal.*

## Finding your way around the menus

The Main Menu is the hub for all configuration choices. It consists of 11 submenus. All configuration options are exercised from within these submenus. The Main Menu, as viewed from the Monitor Utility, is shown:



The table below is a quick reference resource to help you find your way around the submenus:

Name of submenu	Functions
▪ <b>Edit Chassis</b>	▪ Set parameters for the entire RAID system
▪ <b>Quick Setup</b>	▪ Quickly establish a single array – see Chapter 3
▪ <b>Edit Array</b>	▪ Reconfigure, delete or set parameters for a single or multiple arrays
▪ <b>Edit Chan</b>	▪ Set host and disk channel parameters including LUN mapping
▪ <b>View Config</b>	▪ View system and RAIDS settings
▪ <b>RS232 Params</b>	▪ Set parameters for modem connection and RS232 connection to terminal
▪ <b>User Params</b>	▪ Set / enable / disable password security ▪ Configure fax and pager alert settings
▪ <b>Save Config</b>	▪ Save new configurations
▪ <b>Restart</b>	▪ Restart or shutdown the RAID controller
▪ <b>Utility</b>	▪ Enable/ Disable beeper ▪ Check existing arrays ▪ Add and remove disks to existing arrays ▪ Cancel / start disk rebuilding ▪ Cancel error messages ▪ Expand array ▪ View slot information ▪ Update firmware

## Accessing the Main Menu

The section describes in detail the steps needed to call up the Main Menu using both the Monitor Utility and Control Panel.

### Using the Monitor Utility

1. Run HyperTerminal (or the terminal program used to establish an RS232 connection with ACS-9910) and open the connection established with ACS-9910 in Chapter 4.
2. Press Ctrl D to launch the Monitor Utility. The Menu area will be blank.
3. The Output area is active. Press **Tab** once to switch to the Menu area.
4. With the Menu area active, press **Enter**. You will be prompted to enter a password.



5. Enter the password.



#### Note

*The default password is 00000000 (eight zeros). The system administrator should change this on first login. The password can be changed under the User Params Menu.*

6. Press **Enter**. The **Main Menu** will appear.

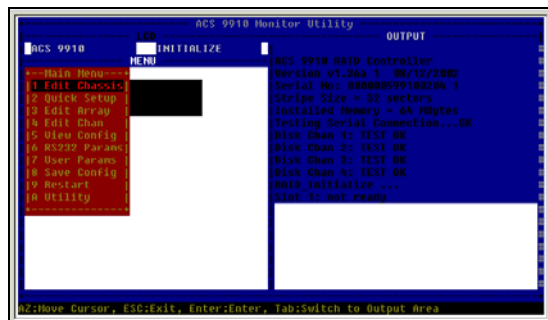



### Using the Control Panel

ACS-9910

NO RAID

Enter Passwd:

0 

1. Turn on ACS-9910. The controller will enter self-diagnostic mode and automatically enter Operation Mode. A typical operation mode screen is shown
2. Press **Enter** to enter configuration mode. You will be prompted to enter the Password. The default password is **00000000** (eight zeros). To enter this, simply press **Enter** eight times. Press **Enter** again to submit.



#### Note

*The default password is 00000000 (eight zeros). The system administrator should change this on first login. The password can be changed under the **User Params Menu**. See Password Security.*

Main menu

1 Edit Chassis

3. You enter the Main Menu. Use the scroll keys to highlight the names of submenus and press **Enter** to select.

## Setting system parameters

System parameters are those that are common to all arrays in a RAID system. They are set and reconfigured from the **Edit Chassis** submenu located at Main Menu > Edit Chassis Menu.

### Edit Chassis Menu

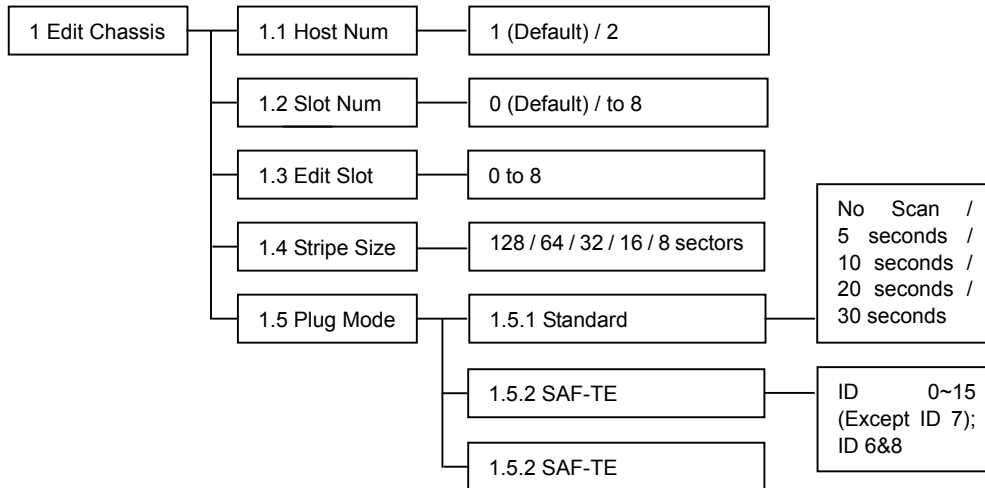

#### 1.1 Host Num

Select the number of SCSI Host bus channels that you want to be able to access the RAID data. This item allows you to either setup a single (select **1**) or dual (select **2**) host configuration. The default setting is **2** hosts (allowing up to two disk channels without the addition of an expansion daughter board).

**1.2 Slot Num**

Set the maximum number of SCSI drives you want to configure (**0~8**).

Formula: slot number = (maximum of disks) x number of disk channels

For example:

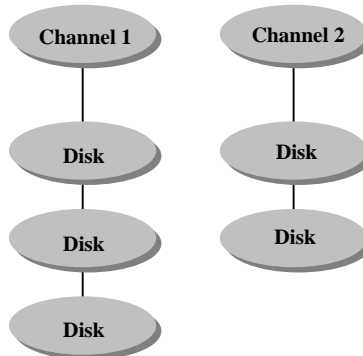

Slot Number:  $3 \times 2 = 6$

**1.3 Edit Slot**

Assigns a specific slot to a special channel and ID number. Use this item to resolve possible conflicts.

**1.4 Stripe Size**

Set stripe block size, which may range from **8~128** sectors (Default: **32**).



**Note**

*Stripe size is constant for any RAID system, whether it consists of a single or multiple arrays.*



**Note**

*Smaller stripe sizes provide faster access for small randomly-accessed files. Larger stripe sizes increase transfer rates for large sequentially-accessed files (such as video).*

**1.5 Plug Mode**

Chose one of three plug modes to make use of the hot swap function.

**1.5.1** Standard: Sets the scan time for polling swap. Choose **No Scan**, **5 seconds**, **10 seconds**, **20 seconds** or **30 seconds**.

**1.5.2** SAF-TE: Sets SAF-TE ID for SCSI. Choose from **0~6**, **8~15** and **6&8**.

**1.5.3** Proprietary: If users use the Accusys proprietary back plane with ACS-9910, they can choose this option for plug mode.

## Setting array parameters

ACS-9910 supports up to 4 separate arrays, each of which may have its own RAID level. Different arrays, when created on different hard disks, can be installed on different device channels. The parameters of the individual ACS-9910 array (or arrays) are set and reconfigured from the **Edit Array** submenu located at Main Menu > Edit Array.

### Edit Array Menu

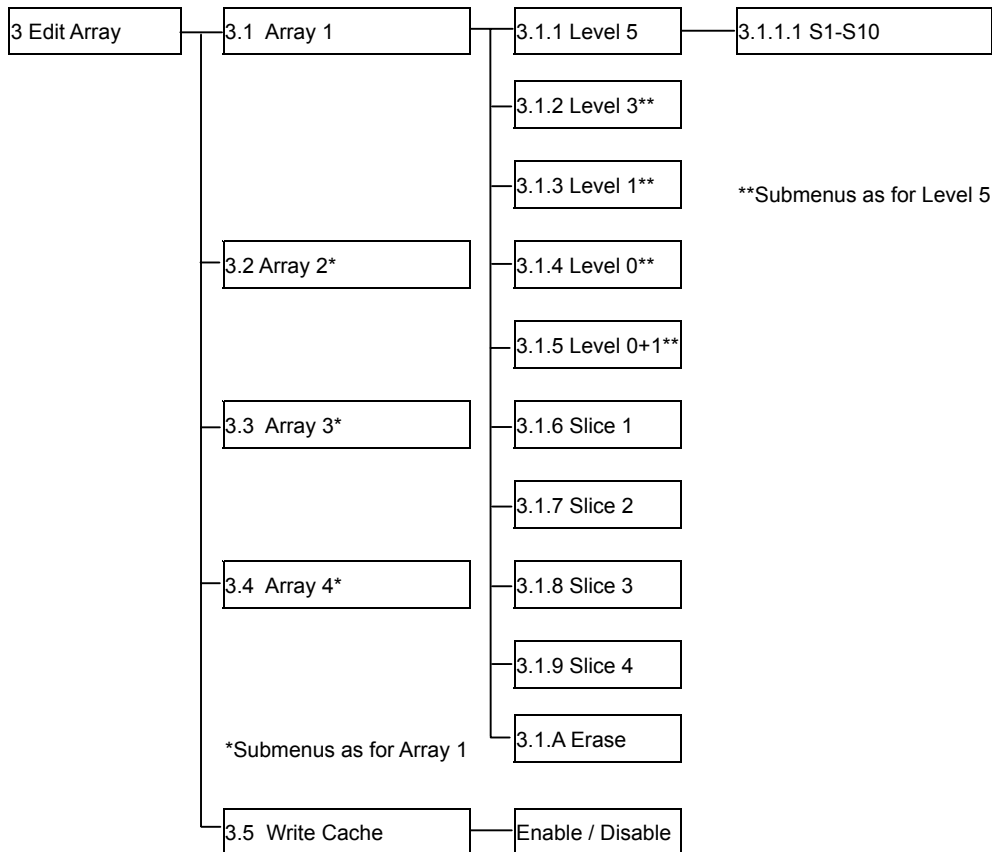



**Caution**

*Data lost during array reconfiguration cannot be recovered. You are strongly advised to backup all data before reconfiguring.*

#### 3.1-3.4 Array 1/Array 2/Array 3/Array 4

For each array you wish to set up or edit, first select: a RAID level, then define the size of array slices (or choose not to partition the array).

**3.x.1 ~  
3.x.5**

**RAID level**

Select from **RAID 5**, **RAID 3**, **RAID 1**, **RAID 0** and **RAID 0+1**.

**3.x.x.1**

**Slot number**

Specify the number of disks to be included in the array.

**3.x.6 ~  
3.x.9 Slice  
1~4**

Each array can be partitioned into up to 4 slices. Input the size in MB of each slice or select **Delete** to delete the slice. All RAID capacity is assigned by default to Slice 0. If the user reduces the size of Slice 0, all excess capacity will be assigned automatically to Slice 1, and so on through the list. Slices (partitions) are created in this way. If no capacity is allocated to a slice, that slice will not be created.



**Note**

*A slice must be mapped to a LUN before it can be accessed. After creating slices, users should go to the Edit Chan Menu to map each to a LUN.*

**3.x.A**

**Erase**

Select to erase an existing array. This item is not shown when the array is not yet setup.

**3.5**

**Write Cache**

**Enable / Disable** buffer for write operations to memory. The use of cache memory when writing to the controller will increase overall performance. The size of the available cache writing space is defined by the size of the SODIMM memory module installed. See **Chapter 2, Installation** for more information on the memory module specifications.

## Setting connection parameters

Use this section to define the configuration of the host and controller device channels.

### Edit Chan Menu

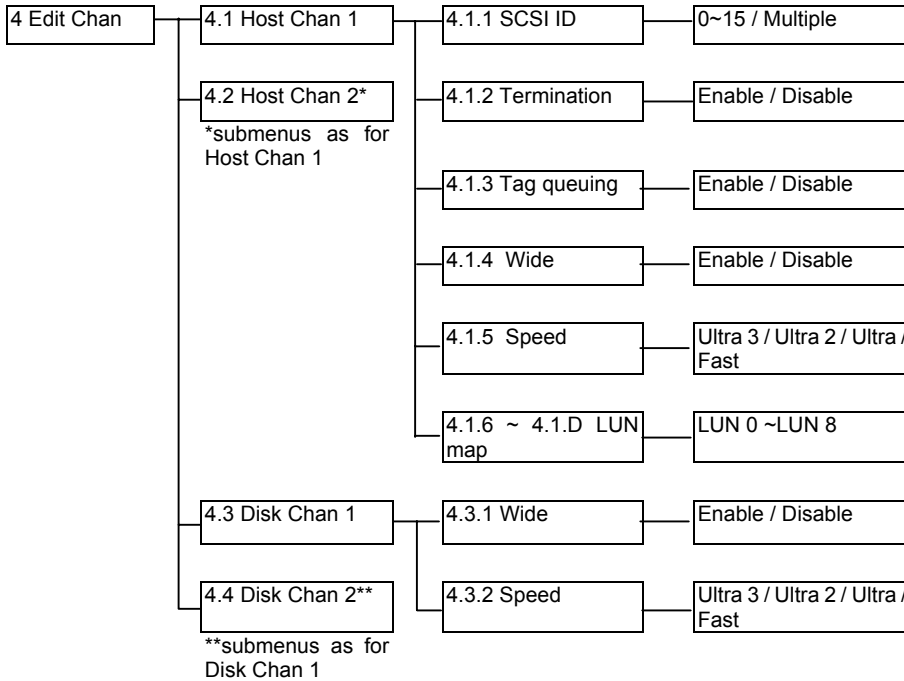

#### 4.1 ~ 4.2 Host Channel

Select a host channel to configure



#### Note

ACS-9910 can be set up with two host channels and two disk channels, or a single host channel and up to three disk channels. Turn to Setting System Parameters earlier in this chapter for details.

#### 4.1.1 Set SCSI ID

Select **0** to **15** or **Multiple** (Default: 0). ID 7 is usually reserved for the host SCSI card.

#### 4.1.2 Termination

**Enable** or **Disable** (Default: Enable). Disable termination if a terminator has been installed on each SCSI bus



#### Note

If ACS-9910 is the only SCSI device on the bus or is at the end of a daisy chain the termination should be enabled. If ACS-9910 is in the middle of a daisy chain the termination should be disabled.

**4.1.3 Tag queuing**

**Enable** or **Disable** (Default: Enable). Tag Queuing allows ACS-9910 to process multiple requests from the host without having to serialize the operations thus improving performance.

**4.1.4 Wide**

**Enable** or **Disable** (Default: Enable).

**4.1.5 Speed**

**Ultra 3, Ultra 2, Ultra** or **Fast** (Default: Ultra 3). See table below for settings

SCSI Interface	Wide	Fast	Ultra	Ultra2	Ultra 3
SCSI-2	Disable	[ENT]			
Wide SCSI	Enable	[ENT]			
Ultra SCSI	Disable		[ENT]		
Ultra Wide SCSI	Enable		[ENT]		
Ultra 2 SCSI	Enable			[ENT]	
Ultra 160 SCSI	Enable				[ENT]

**4.1.6 ~ 4.1.D Lun Map**

Select a *Logical Unit Number* (**LUN 0** to **LUN 7**) and a corresponding slice on which to map it.



**Note**

*An array may be divided into several logical units (that portion of a disk array seen by the host system as a single logical device). ACS-9910 can support up to eight logical units in total.*

**4.3 ~ 4.4 Disk Chan**

Select a host channel to configure.

**4.3.1 Wide**

**Enable** or **Disable** (Default: Enable).

**4.3.2 Speed**

**Ultra 3, Ultra 2, Ultra** or **Fast** (Default: Ultra 3). See table above for settings

## Checking configuration

### View Config Menu

Overview of the settings defined in the items above. Use this section for a quick review of your configuration.

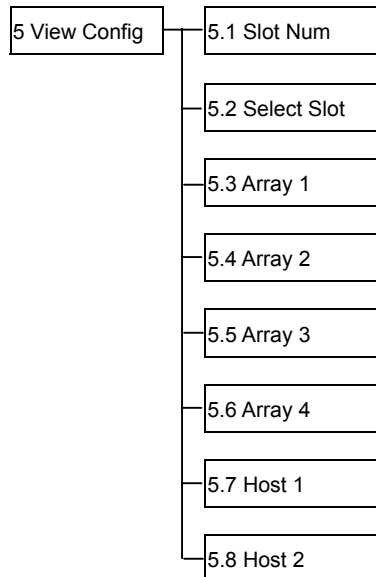

- 5.1 Slot No.**  
View slot number (default: 8).
- 5.2 Select Slot**  
View disk information.
- 5.3-5.6 Array 1/Array 2/Array 3/Array 4**  
View array information.
- 5.7-5.8 Host 1/Host 2**  
View host information.



## Setting port parameters

### RS232 Params Menu

The administrator should specify the communication protocols between ACS-9910 and the external modem and between ACS-9910 and the remote terminal or terminal emulation software. This is done in the **Modem Port Menu** located at Main Menu > RS232 Params Menu > Modem Port Menu and the **Terminal Port Menu** located at Main Menu > RS232 Params Menu > Terminal Port Menu.

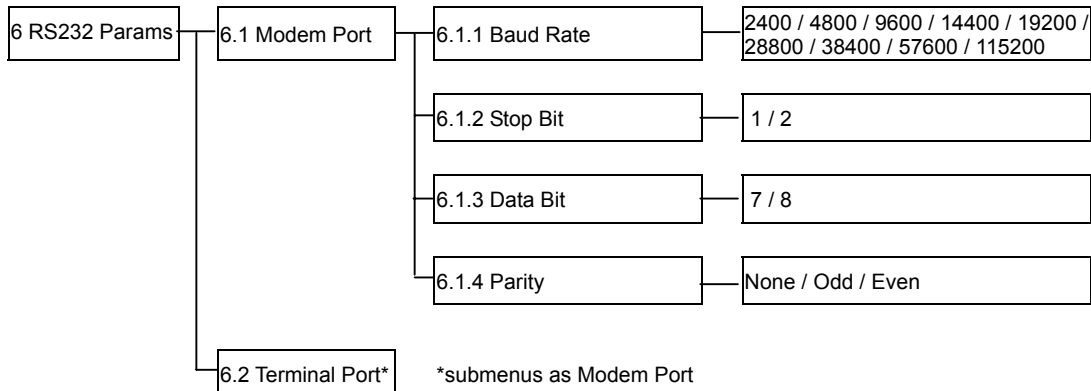

### Modem Port Menu

#### 6.1 Modem port

Set the baud rate, Stop bit, data bit and parity parameters for the modem port to match those of the modem (see modem product documentation).

##### 6.1.1 Baud Rate

**2400, 4800, 9600, 14400, 19200, 28800, 38400, 57600 or 115200** (Default: 19,200)

##### 6.1.2 Stop Bit

**1 or 2** (Default: 1)

##### 6.1.3 Data Bit

**7 or 8** (Default: 8)

##### 6.1.4 Parity

**None, Odd or Even** (Default: None)

### Terminal Port Menu

#### 6.2 Terminal Port

Set the baud rate, Stop bit, data bit and parity parameters for the terminal port to match those of the host.

##### 6.2.1 Baud Rate

**2400, 4800, 9600, 14400, 19200, 28800, 38400, 57600 or 115200** (Default: 19,200; Recommended: 115,200)

**6.2.2 Stop Bit**  
1 or 2 (Default: 1)

**6.2.3 Data Bit**  
7 or 8 (Default: 8)

**6.2.4 Parity**  
None, Odd or Even (Default: None)



**Note**

*The remote terminal settings and those of ACS-9910 must match. So, if the administrator increases the Baud rate of the ACS-9910 port, the baud rate of the terminal emulation software (e.g. HyperTerminal) connection must likewise be increased.*

## Password security

The administrator can enable password security and set the password from the **Password Info** submenu located at Main Menu > User Params Menu > Password Info

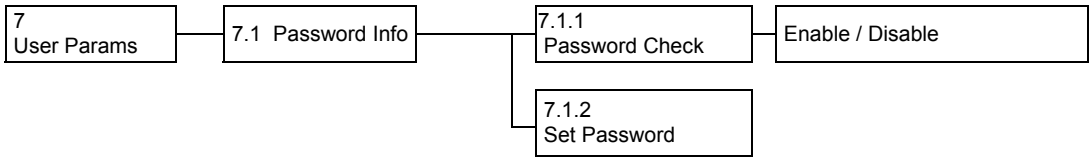

### Password Info Menu

**7.1.1 Password check**

**Enable** or **Disable** the Password security feature. When enabled, users will be asked to enter the password when first accessing the Main Menu (Default: Disable).

**7.1.2 Set Password**

Enter a password of up to eight alphanumeric figures. The default password is **00000000** (eight zeros).



**Note**

*Configuration changes made in the Password Info Menu must be saved to the ACS-9910 non-volatile memory to take effect. This is done in the Save Config Menu located at Main Menu > Save Config Menu. See Saving Configurations later in this chapter.*

## Entering and editing alert settings

The administrator can specify two fax numbers and two pager numbers to which alert messages will be sent in the event of an error with ACS-9910. To configure alert settings, follow the instructions in succeeding sections to:

1. Configure pager settings
2. Configure fax settings
3. Configure modem
4. Update settings in the Save Config submenu



### Note

*A modem must be connected to ACS-9910 via the combo cable modem connector for the alert feature to work.*

## Pager alert settings

Pager alert settings are all entered and edited from the **Pager Info** submenu, located at Main Menu > User Params Menu > Pager Info

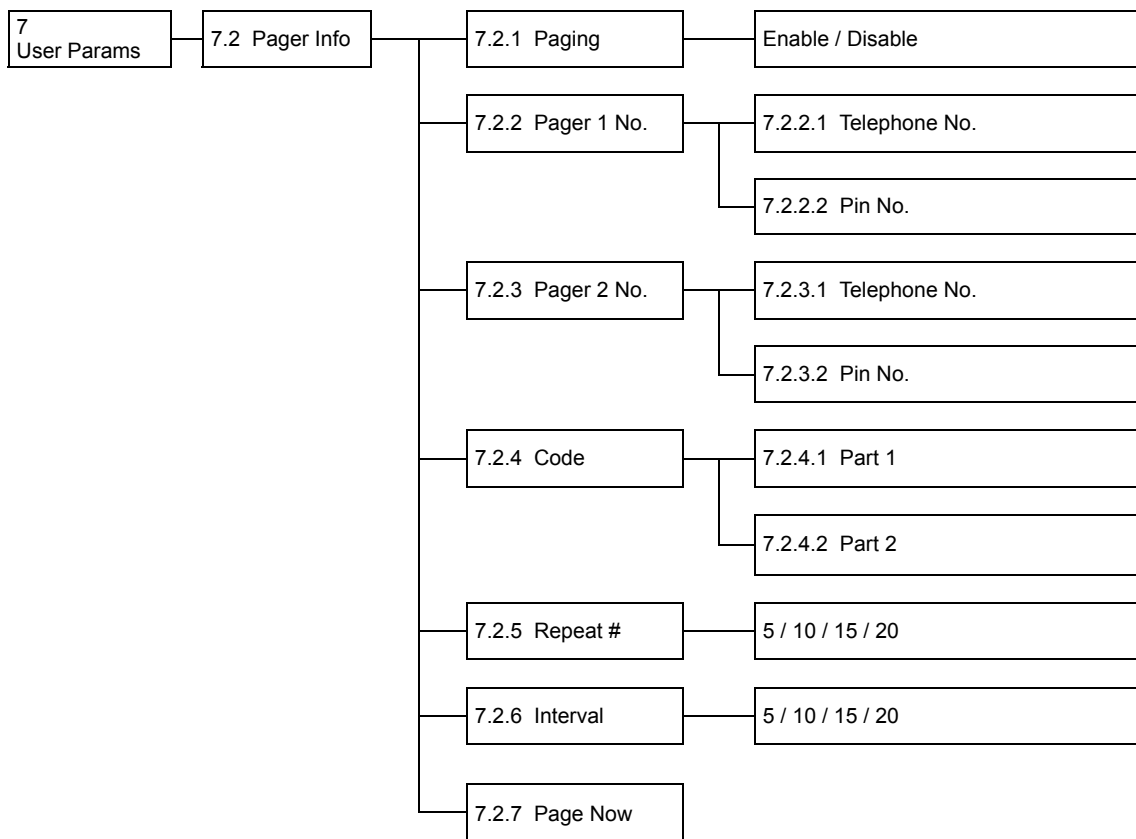

## Pager Info Menu

### 7.2.1 Paging

**Enable** or **Disable** the Pager alert function (Default: Disable)

### 7.2.2 Pager 1 No.

Enter the first pager's terminal **telephone number** (also called the 'port number' or 'TAP port number') and the pager **pin number** (if required for pager). Maximum 16 characters.

### 7.2.3 Pager 2 No.

Enter the second pager's terminal telephone number (also called the 'port number' or 'TAP port number') and the pager pin number (if required for pager). Maximum 16 characters.

### 7.2.4 Code

Enter the alert message for pager 1 under **Part 1**.

Enter the alert message for pager 2 under **Part 2**.

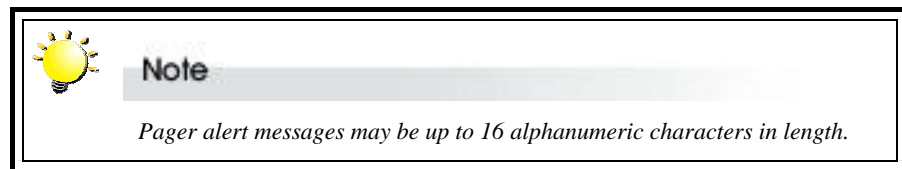

### 7.2.5 Repeat #

Select how many times the alert message(s) should be sent: **5, 10, 15** or **20** times (Default: 5).

### 7.2.6 Interval

Select the interval between dispatch of repeated alert messages: **5, 10, 15** or **20** minutes (Default: 5).

### 7.2.7 Page Now

Instruct ACS-9910 to send a test pager alert immediately.

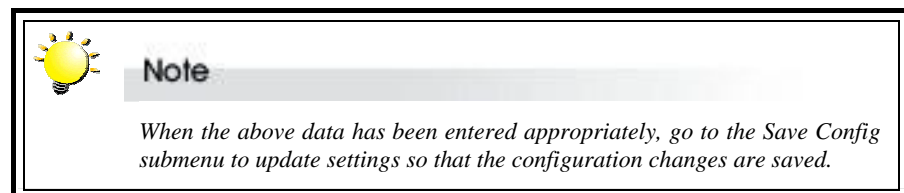

## Fax alert settings

Fax alert settings are entered and edited from the **Fax Info** submenu, located at Main Menu > User Params Menu > Fax Info

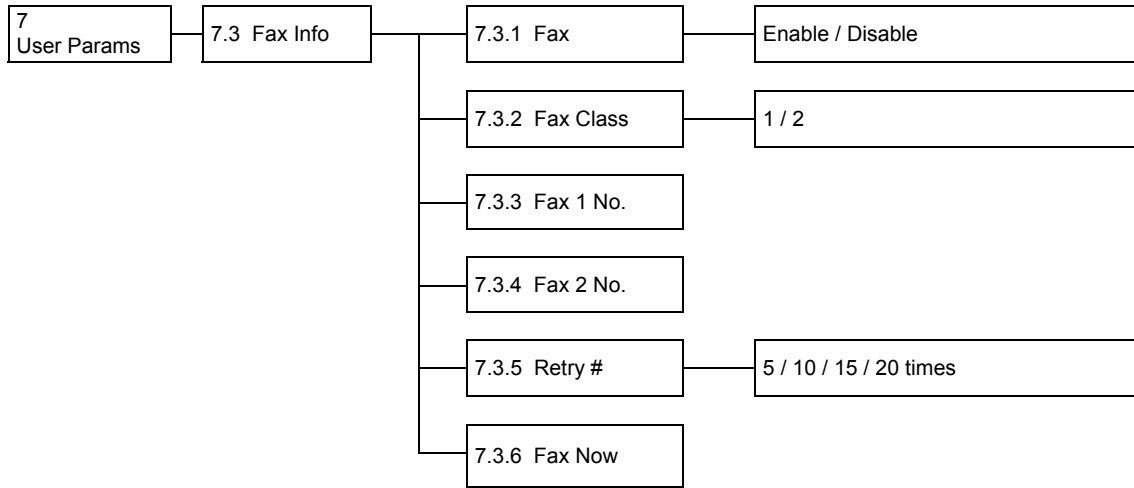

The fax includes configuration and system status information.

### Fax Info Menu

- 7.3.1 FAX**  
Enable or **Disable** the Fax alert function (Default: disable).
- 7.3.2 FAX Class**  
Define the Fax class supported by the modem, either **1** or **2**.
- 7.3.3 FAX1 No.**  
Enter the first fax number (two alert fax numbers can be input).
- 7.3.4 FAX2 No.**  
Enter the second fax number (two alert fax numbers can be input).
- 7.3.5 Retry #**  
Select how many times the alert message(s) should be sent: **5**, **10**, **15** or **20** times (Default: 5).
- 7.3.6 FAX Now**  
Instruct ACS-9910 to send a test fax alert immediately.

The alert fax header should be input in the **Company Info** submenu, located at Main Menu > User Params Menu > Company Info

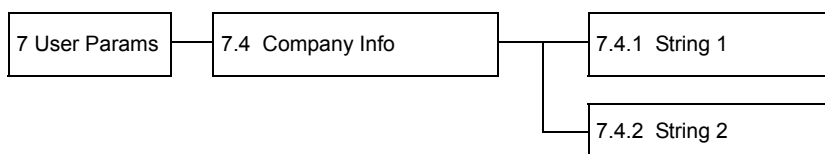

## Company Info Menu

### 7.4.1 String 1

Enter the first line of information to be used as the alert fax header (up to 16 alphanumeric characters).

### 7.4.2 String 2

Enter the second line of information to be used as the alert fax header (up to 16 alphanumeric characters).



#### Note

*When the above data has been entered appropriately, go to the Save Config submenu to update settings so that the configuration changes are saved.*

## Modem settings

Before the fax and pager alerts are used the default Modem Initialization string should be confirmed or a new string entered. Do this in the **Modem Init St** submenu, located at Main Menu > User Params Menu > Modem Init St

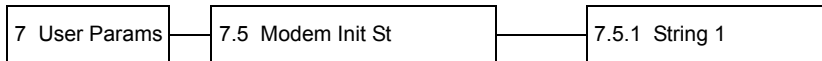

## Modem Init St Menu

### 7.5 Modem Init St

Configures the modem you are using for the remote notification feature.



#### Note

*The default string is a generic string compatible with most modems. Refer to your modem user's guide to check if your modem requires a different string.*



#### Note

*Configuration changes made in the User Params Menu must be saved to the ACS-9910 non-volatile memory for the changes to take effect. This is done in the Save Config Menu located at Main Menu > Save Config Menu. See Saving Configurations below.*

## Saving configurations

Any configuration changes made by the administrator must be saved to the non-volatile memory (NVRAM). This is done in the **Save Config Menu** located at Main Menu > Save Config Menu

### Save Config Menu



**Caution**

*Any changes made in this menu will cause data on the drives to be permanently erased. ACS-9910 should be offline before configuration changes are saved.*

**Note**

*ACS-9910 must be restarted for any configuration changes made within the Edit Chassis, Quick Setup, Edit Array, and Edit Chans Menus to take effect.*

## Restarting the controller

The controller must be restarted for any configuration changes made within the Edit Chassis, Quick Setup, Edit Array, and Edit Chans menus to take effect. Configuration changes made from the RS232 Params, User Params and Utility menus do not require restart.

### Restart Menu

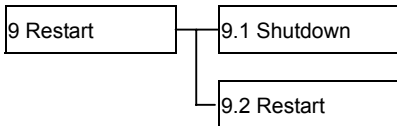

Choose to either **shutdown** or **restart** the controller and confirm by selecting **Yes**.

## Advanced settings

### Utility Menu

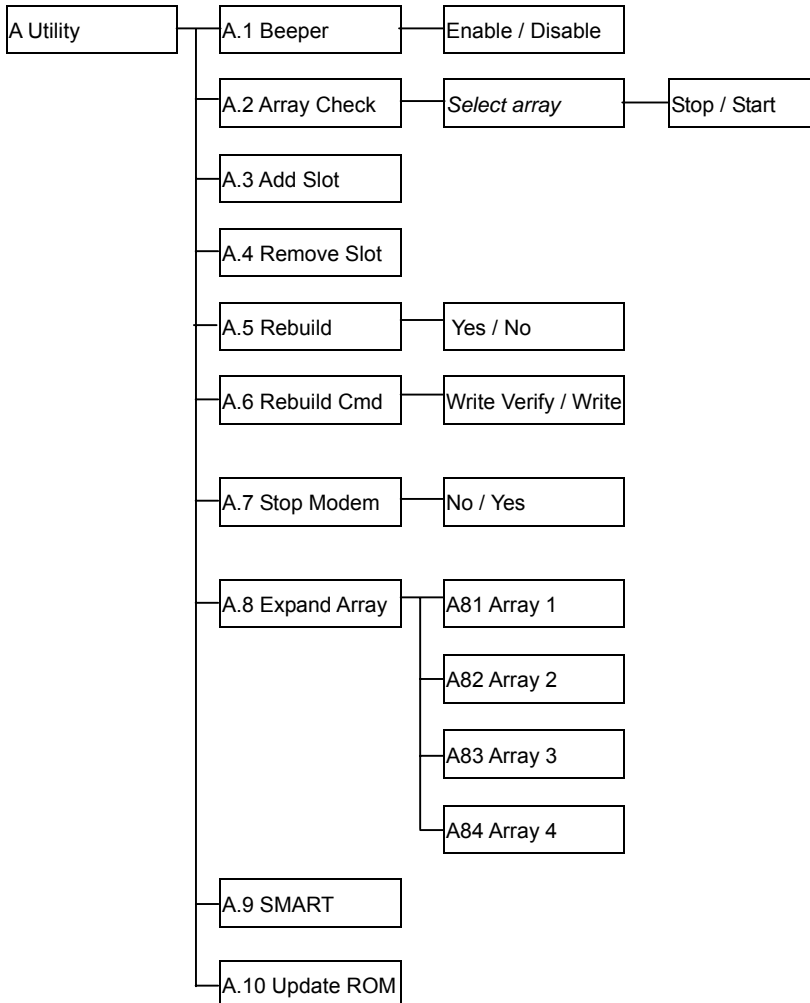

### A. Utility

Use this section to control some of the basic ACS-9910 functions.

#### A.1 Beeper

**Enable** or **Disable** the audible signal in case of system malfunction.

#### A.2 Array Check

Select Array 1, 2, 3 or 4 and then Stop or Start a parity check on that array (Default: Stop).

#### A.3 Add Slot

Select a slot number (1 to 16) to add a disk to an existing configuration while ACS-9910 is online (Default: None).



#### A.4 Remove Slot

Select a slot number (1 to 16) to remove a disk from an existing configuration while ACS-9910 is online. This function enables the administrator to shutdown a potentially faulty disk. If a spare drive is present, it will automatically be added (Default: None).



#### Caution

*Removing a disk drive may cause data loss. Always make sure that you have backed up the data of the affected array.*

#### A.5 Rebuild

Select **Yes** or **No** to start or stop disk rebuilding.

#### A.6 Rebuild Cmd

Define the rebuilding method, either **Write Verify** (more reliable) or **Write** (Faster).

#### A.7 Stop Modem

No or Yes. Select Yes to halt the transmission of subsequent alert faxes / pager messages when the message has been received and acknowledged (Default: No).

#### A.8 Expand Array

Select array to be expanded (Array 1 to Array 4) and then the number of disks in the new array.



#### Note

*Ensure that new disk capacity is equal to or larger than current on-line capacity. To expand an array. To expand disk capacity:*

- ⇒ *Connect new disk*
- ⇒ *Use Expand Array Menu to select the number of disks in the array*
- ⇒ *Go to the Edit Array Menu. The new capacity will appear in a new slice. So if you have already set up Slice0, Slice1 and Slice2, the new capacity will form Slice3. If no slices have been formed before (i.e. there is only one partition: Slice0), the new capacity will be in Slice1.*



#### Caution

*Expanding an array increases array capacity but data may sometimes be lost. You are strongly advised to make a system backup before proceeding.*

**A.9 Smart**

Select to display information about each slot in the Monitor Utility Output window (this information cannot be viewed from the control panel).

**A.10 Update ROM**

Use this option to update the ACS-9910 programmable firmware. See *Updating the Firmware* later in this chapter.

**Note**

*Configuration changes made in the Utility Menu must be saved to the ACS-9910 non-volatile memory for the changes to take effect. This is done in the Saving Config Menu located at Main Menu > Saving Config Menu. See **Saving Configurations** earlier in this chapter.*

## Updating the Firmware

ACS-9910 is shipped with firmware installed. The user may however wish to download new or upgraded editions of the firmware to the controller. Ask your vendor about the latest firmware edition or refer to the website [www.accusys.com.tw](http://www.accusys.com.tw)

A terminal emulation program, such as HyperTerminal, is required to download firmware.

**Caution**

*Shutdown the host computer system(s) before downloading the new firmware.*

**Note**

*Array data and configurations are not affected by updating of firmware.*

To update the firmware:

1. Open the Update ROM submenu (A.10) located at Main Menu > Utility > Update ROM Menu.



2. You will be asked: Are you ready to download the new firmware?(Y/N) Type Y to continue.
3. When asked: Are you sure? (Y/N) Type Y to reconfirm.

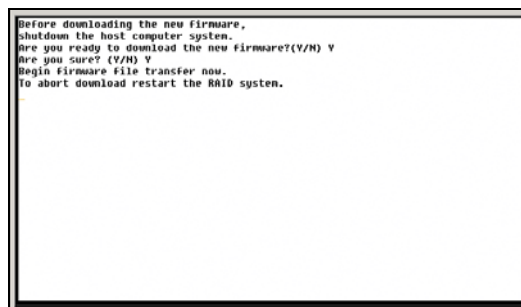

4. Locate the updated firmware file to send. If using HyperTerminal, go to the **Transfer** menu and select **Send Text File...**

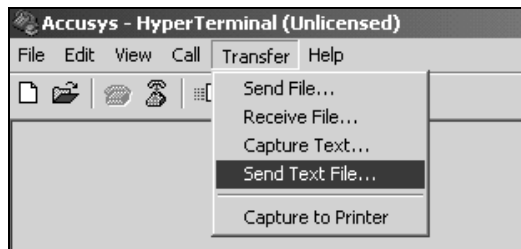

Send firmware file as a text file. The file will start to download. When prompted, enter Go (case sensitive) to update the firmware.

When prompted, enter **Go** (case sensitive) to reconfirm. The firmware will start to update.

If asked whether you want to replace the existing file, enter **Yes**.

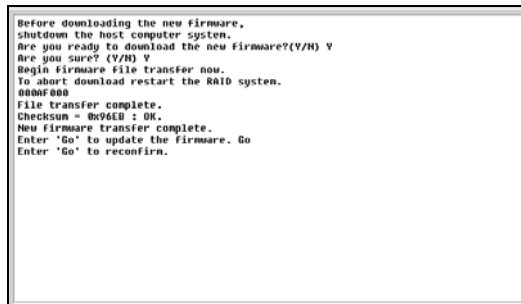

## Appendix A

**Troubleshooting****Problems setting up****Newly installed memory fails during Self-Test or is not detected.**

Possible Cause: The Memory SO-DIMM module may not be properly seated or may not be supported by ACS-9910.

Fix: Re-sit the memory module in the socket and retry. If it continues to fail try moving it to the other memory socket. Make sure the correct memory type is being installed. ACS-9910 supports 144-pin SO-DIMM SDRAM.

**Unable to access ACS-9910 after the operating system boots up.**

Possible Cause: ACS-9910 is not configured.

Fix: Make sure ACS-9910 is configured for a RAID level. If no RAID level is configured the operating system will not detect ACS-9910 as a disk drive.

**I try to set up an array using Quick Setup but fail. Why?**

Possible Cause: If the error message Array1 Exists! appears, an array has already been configured. Quick Setup can only be used to set up new arrays.

Fix: Reconfigure the array from the Edit Array submenu

**Problems during operation****The front panel LCD displays alternating "Zz" characters.**

Possible Cause: These characters are displayed when the cache is full with write request data that have not been processed. Requests from the host are halted to flush the data in the cache.

Fix: None needed.

**The front panel LCD displays alternating "Ww" characters.**

Possible Cause: These characters are displayed to indicate that write requests in the cache are being processed. When these characters are displayed, ACS-9910 will halt requests from the host (see above).

Fix: Make sure the *Write Cache* option of the *Edit Array* menu is enabled. In addition, more cache memory may be required. By increasing the cache memory, the write buffer space increases and will be able to handle the higher write requests.

**Data loss for Windows 2000 during system shutdown**

Possible Cause: RAID controller is a built-in host and some data is still in cache buffer during system shutdown.

Fix 1: Set *Cache Off*

Fix 2: To shutdown, select *Restart system* and wait for about 30 seconds, then turn off power.

Fix 3: Shutdown host OS after shutting down controller.

## Remote terminal problems

### Unable to access Configuration Mode using the remote terminal interface.

Possible Cause 1: The terminal communication settings do not match the settings of the ACS-9910 RS-232 interface.

Fix: The default settings for the RS-232 port are 19,200 Baud rate, 8 Data bits, 1 Stop bit, No Parity, and XON/XOFF Flow control. Make sure the terminal is configured for these settings. If the settings were changed in Configuration Mode, verify the settings of the ACS-9910 in the RS-232 Params, Terminal option and change the terminal settings accordingly.

Possible Cause 2: Incompatible RS232 cable.

Fix: Cross pins on the RS-232 cable as shown below (or use a null modem cable). The only pins used are 2 3 & 5.

1 2 3 4 5 6 7 8 9

X I

1 2 3 4 5 6 7 8 9

## Alert message problems

### I am unable to send a Page or FAX using the modem port.

Possible Cause 1: The Page and Fax options are not enabled.

Fix: Go to the Configuration Mode and enable Page and FAX notification via the User Params menu option.

Possible Cause 2: The default modem initialization string is not compatible with your modem.

Fix: Change the modem initialization string in the User Params option. Refer to your modem manual for its initialization string.

The following modem models require their own initialization strings.

Modem Model	Initialization String	Baud Rate	FAX Class
Motorola ModemSURFR V.34 28.8	AT&D\Q1E	Up to 38400	1 & 2
Multitech Multimodem 2834ZDX	AT&D0&E5E0	Up to 38400	2 only
Hayes Accura 288 V.34+FAX	AT&D0&K4E0	38400 only	1 & 2
Practical Peripherals PM144MT II	AT&K4	Up to 38400	2 only
GVC F-1128V/T2	AT&D0&B1&H2	38400 only	1 & 2
US Robotics Sportster 28800	AT&H2&I1&R1&B1	38400 only	1 only

**Appendix B****Introduction to RAID levels**

The ACS-9910 can support the following RAID levels: 0, 1, 3, 5 and 0+1.

Which is the right level for you? The answer depends on the application you use your RAID for.

**RAID Level 0** offers high transfer rates, and is ideal for large blocks of data where speed is of importance. Computer Aided Design, Graphics, Scientific Computing, Image and Multimedia applications are all good examples. If one drive in a RAID 0 array fails however, the data on the whole array is lost.

**RAID Level 5** arrays offer high I/O transaction rates, and are the ideal choice when used with on-line transaction processing applications, such as those used in banks, insurance companies, hospitals, and all manner of office environments. These applications typically perform large numbers of concurrent requests, each of which makes a small number of disk accesses. If one drive in a RAID 5 array fails, the lost data can be rebuilt from data on the functioning disks.

**RAID Levels 3 and 5** both offer a good level of fault tolerance and overall system reliability at a reasonable cost for redundancy overhead.

**RAID Level 1** may be an appropriate choice if cost and performance are of significantly less importance than fault tolerance and reliability.

**RAID Level 0** may conversely be a suitable choice if fault tolerance and reliability are not important.

This appendix provides a summary of the features of each RAID level to enable users with differing requirements to make the best choice.

## RAID 0

RAID 0 links each drive in the array as one huge drive. Storage capacity is determined by the smallest drive in the array. That capacity is then applied to format all other drives in the array. If using a 40 GB, 60 GB, and 50 GB drive in a RAID 0 array, your system will see one huge drive of 120 GB (40 GB×3).

RAID 0 offers double or more performance under sustained data transfers when one drive per ATA port is used. In such a configuration, unlike SCSI, ATA drives are always available to the system. SCSI requires more management of the SCSI bus.

### **RAID 0:** *Striped disk array without fault tolerance*

#### **Characteristics:**

- RAID 0 implements a striped disk array, the data is broken down into blocks and each block is written to a separate disk drive.
- I/O performance is greatly improved by spreading the I/O load across many channels and drives.
- Fastest and most efficient array type but offers no fault-tolerance.
- Storage capacity = (No. of disks) × (capacity of smallest disk)

#### **Recommended use:**

- Video production and editing
- Image editing
- Pre-press applications
- Any application requiring high bandwidth

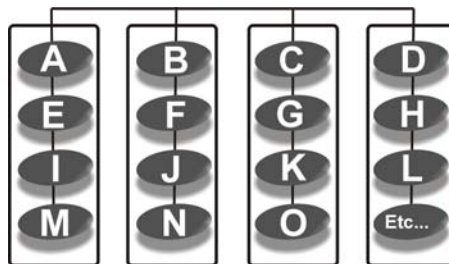

**Arrangement of data blocks saved on a Level 0 array**

## RAID 1

RAID 1 is commonly referred to as Disk Mirroring, Disk Shadowing or Disk Duplexing as all data is duplicated across both disks. As data is identical on both disks, storage capacity is that of the smaller disk. RAID1 has poor performance for write operations but very high performance for read intensive operations.

### RAID 1: *Mirroring*

#### Characteristics:

- Better Read transaction rate than single disks, same Write transaction rate as single disks.
- 100% redundancy of data means no rebuild of data is necessary in case of disk failure, just a copy to the replacement disk.
- All the disks have the same data.
- Raid level 1 requires two drives.
- Storage capacity = Capacity of smaller disk

#### Recommended use:

- Accounting
- Payroll
- Financial
- Any application requiring high availability

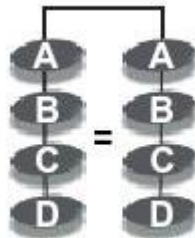

**Arrangement of data blocks saved on a Level 1 array**



## RAID 0+1

RAID 0+1 combines mirroring and striping functions on a minimum of four hard disks. Mirroring provides full redundancy and protects data in case of multiple drive failure (providing that data on one of each mirrored pair of drives is intact).

### **RAID 0+1:** *Combination of striping and mirroring*

#### **Characteristics:**

- This configuration provides optimal speed and reliability.
- Requires even number of disks (minimum 4 disks)

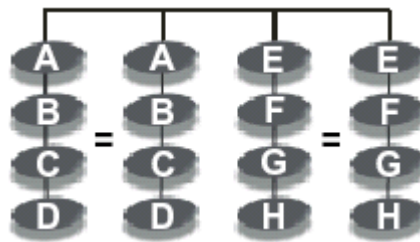

**Arrangement of data blocks saved on a Level 0+1 array**

## RAID 3

RAID 3 uses a mathematical expression that compares data from two drives and calculates a third piece of data called "parity". Should one of the drives fail, parity data can be used to rebuild the failed data. Under RAID 3, parity data is stored on a dedicated parity disk. If two or more disks were to fail however, data would be lost. Data on RAID 3 is byte-interleaved. While the low ratio of parity disks to data disks ensures high efficiency, the parity disk is accessed more than the others and so is also more likely to fail.

### RAID 3: *Parallel transfer with parity*

#### Characteristics:

- The data block is subdivided, i.e. striped, and written on the data disks. Stripe activity is generated on Writes, recorded on the parity disk, and checked on Reads.
- Very high Read and Write data transfer rates.
- Disk failure has a low impact on throughput.
- Low ratio of ECC (Parity) disks to data disks means high efficiency.
- Requires a minimum of three drives.

#### Recommended use:

- Video production and live streaming
- Image editing
- Video editing
- Any application requiring high throughput

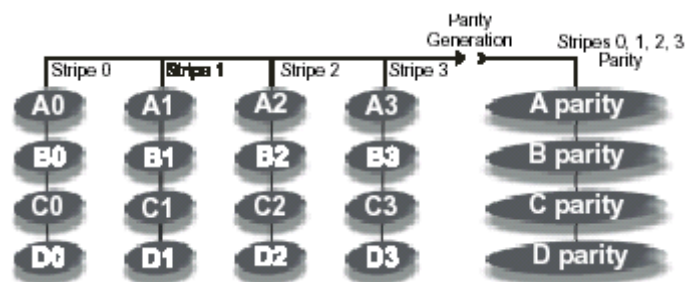

Arrangement of data blocks saved on a Level 3 array

## RAID 5

RAID 5 uses a mathematical expression that compares data from two drives and calculates a third piece of data called “parity”. Should one of the drives fail, parity data can be used to rebuild the failed data. Under RAID 5, parity data is stored across all drives in the array. This maximizes the amount of storage capacity available from all drives in the array while still providing data redundancy. Data on RAID 5 is block-interleaved.

### RAID 5: *Independent data disks with distributed parity blocks*

#### Characteristics:

- Each entire data block is written on a data disk. Parity for blocks in the same rank is generated on Writes, recorded in a distributed location and checked on Reads.
- Highest Read data transaction, medium Write data transaction rate.
- Relatively low ratio of ECC (Parity) disks to data disks means high efficiency (compared to other RAID levels).
- Good aggregate transfer rate.
- Storage capacity = (No. of disks – 1) × (capacity of smallest disk)

#### Recommended use:

- File and application servers
- Database servers
- WWW, E-mail and News servers
- Intranet servers
- Most versatile Raid level

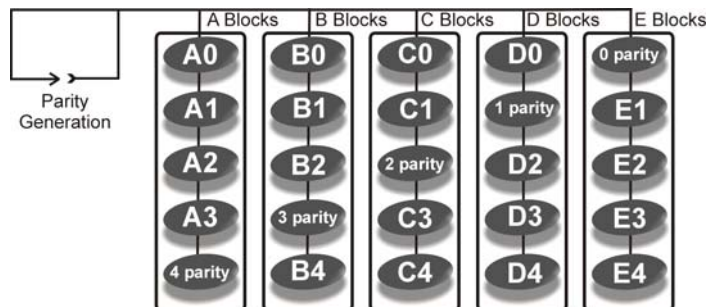

Arrangement of data and parity blocks saved on a Level 5 array

Appendix C

# Optional Components

The addition of an optional proprietary daughter-board to the ACS-9910 RAID Controller increases the number of channels available and provides extra features.

## SCSI daughterboard (ACS-7480)

The ACS-7480 adds an extra two SCSI channels to the RAID controller.

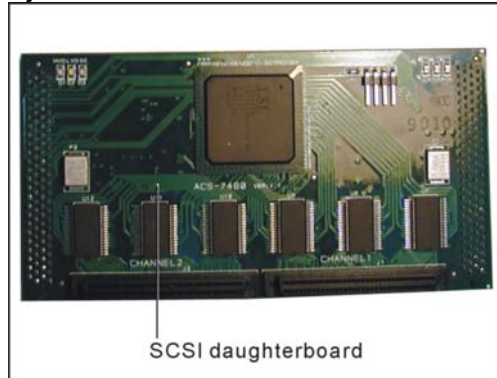

## Fibre daughterboard (ACS-7140)

The ACS-7140 adds an extra two fibre channels to the RAID controller.

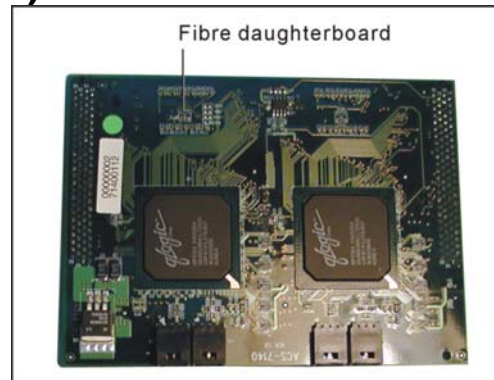

## Removing / replacing daughterboard

To install a daughterboard, ensure the system power is off and disconnected. Then:

Remove any screws securing the controller box cover, then slide the cover back and lift off.

Line up the connectors on the daughter-board with the daughterboard connectors on the controller board.

Press down firmly.

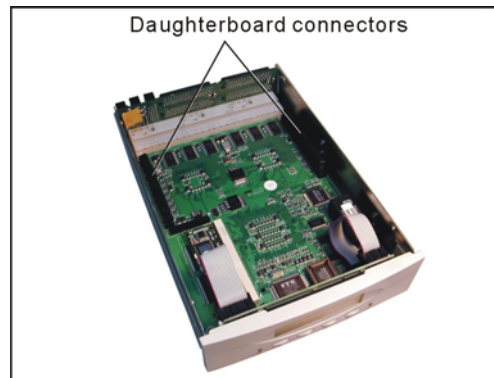

To remove a daughterboard:, simply lift it gently but firmly to disconnect from the controller board connectors.

**Appendix D****Control Panel Messages & Alarms****Status messages**

When ACS-9910 is in operation mode, scroll buttons ▼ and ▲ can be used to display the following system data:

- Installed Memory
- CPU Type
- Firmware Version
- Serial Number
- Individual Slot Data

**Error Messages and Alarms**

The following is a list of the error messages generated by ACS-9910 (with accompanying alarm signals from the controller box) and their meaning.

Error Message	Alarm	Explanation
Migrate error / Stripe error	Constant alarm	<ul style="list-style-type: none"> <li>● Incorrect stripe size. Could cause system failure</li> <li>● Change to disk sequence. Could cause system failure</li> </ul>
Lose disk	Constant alarm	A disk drive is not installed or cannot be accessed. Could cause system failure.
No free slot	Constant alarm	Not enough free slots. Could cause system failure
Fail x	Succession of beeps	Failure of disk on slot x
UPS fail	Beeps at 5 second intervals	Failure of UPS
Fan fail	Beeps at 5 second intervals	Failure of fan
Power fail	Beeps at 5 second intervals	Failure of power
Temp warn	Beeps at 5 second intervals	Temperature too high
Init y%	One beep per percentage point of progress	Array initialization y% complete
Check y%	One beep per percentage point of progress	Array check y% complete
Add y%	One beep per percentage point of progress	Array addition y% complete

**Appendix E****Glossary****Array**

See Disk Array.

**Array Management Software**

The body of software that provides common control and management for a disk array. Array Management Software most often executes in a disk controller or intelligent host bus adapter, but may also execute in a host computer. When it executes in a disk controller or adapter, Array Management Software is often referred to as Firmware.

**Cache**

Controller memory used to speed up data transfer to and from a disk.

**Disk Array**

A collection of disks from one or more commonly accessible disk controllers, combined with a body of Array Management Software. Array Management Software controls the disks and presents them to the array operating environment as one or more virtual disks.

**Disk Striping**

The practice of dividing data into blocks and writing the blocks across several drives for increased performance.

**Disk Mirroring**

The practice of duplicating data on different sets of disks in an array.

**Firmware**

See Array Management Software.

**Host Computer**

Any computer system to which disks are directly attached and accessible for I/O. Mainframes, and servers, as well as workstations and personal computers, can all be considered host computers in the context of this manual, as long as they have disks attached to them.

**Hot Spare**

A physical drive, not part of an array, on which the controller can rebuild data if an array drive malfunctions.

**Hot Swap**

The substitution of a (usually defective) unit by a replacement that takes place while the system is online.

### **Logical Unit**

Disk storage space on one or more physical drives that appears to the host computer as a single drive.

### **LUN (Logical unit number)**

The number assigned to a logical unit. Slices of a RAID are assigned (mapped to) LUNs by which they appear to the host computer.

### **Mirroring**

See Disk Mirroring.

### **Parity**

Parity information is redundancy information calculated from actual data values. If any single piece of data is lost, the data remaining and the parity information can be used together to compute the lost data. Parity information can either be stored on a separate, dedicated drive, or be mixed with the data across all the drives in the array.

### **RAID (Redundant Array of Independent / Inexpensive Disks)**

A disk array in which part of the storage capacity is used to store redundant information about user data stored on the remainder of the storage capacity. The redundant information enables regeneration of user data in the event that one of the array member disks or the access path to it fails. See Parity. Different RAID levels offer different data throughput speeds and fault tolerance (data redundancy). RAID 0 does not feature redundant information but is nonetheless considered a special type of RAID.

### **SCSI**

Small Computer System Interface.

### **Slice**

A partition of an array. See LUN.

### **Striping**

See Disk Striping.

## Appendix F

## Specifications

Item	Specifications
Operation System	OS independent and Transparent
CPU	Intel i80303 64-bit RISC microprocessor
SCSI I/O Processor	LSI 53C1010 Ultra160
RAID Level	0,1,3,5,0+1
RAID Architecture	Multiple RAID
Cache Memory	Up to 512MB SDRAM With ECC on board
Dual Controller Capability	Yes (option)
Battery Backup	Yes (option)
SCSI Architecture	Multiple ID & Multiple LUN
SCSI Channel to Host	2(Max) Ultra 160
SCSI Channel to Device	3(Max) Ultra 160
Data Transfer Rate	Up to 160MB/s
Devices support per Channel	15
Disk Drives	Up to 45 drives (1 Host & 3 SCSI Channels)
Tagged Command Queuing	Yes, up to 256 Commands
Stripe Size	Variable
Write Option	Write through or Write Back
Hot Swap	Yes
Hot Spare	Yes (rebuild Transparently & Automatically)
SAF-TE Enclosure Management	Yes
On Line Expansion	Yes
User Friendly GUI man	Yes
Remote Alerts	Fax, Pager
Beeper Alarm	Yes

**Note**

*Specifications subject to change without notice.*



## Appendix G

# Contact Us

### Accusys, Inc.

- 8F, 47 Lane 2, Sec. 2, Kuang Fu Rd., Hsinchu, Taiwan, R.O.C.
- Tel : +886-3-575-0668
- Fax : +886-3-575-0866
- <http://www.accusys.com.tw/>
- e-mail : [sales@accusys.com.tw](mailto:sales@accusys.com.tw)

### Accusys U.S.A., Inc.

- Address: 46710 Fremont Blvd. Fremont, CA 94538, U.S.A.
- Tel:+1-510-661-0800
- FAX:+1-510-661-9800
- Toll-free number:+1-866-277-5888
- <http://www.accusysusa.com/>
- e-mail : [support@accusysUSA.com](mailto:support@accusysUSA.com), [sales@accusysusa.com](mailto:sales@accusysusa.com)

### Accusys Germanay

- Mailander Straße 9 81545 Munchen, Germany
- Tel : +49-89-374-0760
- Fax : +49-89-374-07650
- <http://www.accusys.de/>
- e-mail : [sales@accusys.de](mailto:sales@accusys.de)

### Accusys Korea, Inc.

- Baegang B/D 5F Shinsa-Dong 666-14 Kangnam-Gu, Seoul, Korea
- Tel : (02)6245-9050
- Fax : (02)3443-9050
- <http://www.accusys.co.kr/>
- e-mail : [sales@accusys.co.kr](mailto:sales@accusys.co.kr)

## Accusys China, Inc.

- 1808 Anzhen Plaza, No. 2, Andingmenwai Street, Dongcheng District, Beijing, postcode 100013, China.
- Tel : 010-6448-2530
- Fax : 010-6448-2233