



---

**NETWORK PRODUCTS**

**COMMUNICATIONS CONTROL PROGRAM  
VERSION 3  
REFERENCE MANUAL**

---

**CDC® COMPUTER SYSTEMS:  
255X SERIES  
NETWORK PROCESSING UNIT**

# REVISION RECORD

---

<u>Revision</u>	<u>Description</u>
A (11/10/76)	Initial release under NOS 1; level 438.
B (04/28/78)	Revision to CCP 3.1, cycle 34 plus optional minitape corrective code: PSRs 755, 718A, 729, 757, 773, 784, 828, 834, 835.
C (12/01/78)	Revised to include corrective code release, cycles 35, 36, 37; PSRs 257, 275, 710, 726, 751, 756, 759 thru 763, 773, 779, 784, 792, 800, 801, 803, 804, 807 thru 810, 813, 818, 820, 829A, 836, 841, 843, 853 thru 855, 858, 862, 865, 869, 870, 872, 878 thru 881, 883, 891, 921.
D (06/30/79)	Revised to CCP 3.2 PSR level 497. This revision obsoletes all previous editions.
E (05/22/80)	Revised to reflect PSR level 518.
F (10/09/80)	Revised for CCP release level 3.3, PSR level 528.
G (05/29/81)	Revised for CCP release level 3.4, PSR level 541. Includes PRU interface with Binary Synchronous Communications TIP and 2780/3780 terminal support. This is a complete reprint.

REVISION LETTERS I, O, Q, AND X ARE NOT USED

Address comments concerning this manual to:

©COPYRIGHT CONTROL DATA CORPORATION  
1976, 1978, 1979, 1980, 1981  
All Rights Reserved  
Printed in the United States of America

CONTROL DATA CORPORATION  
Publications and Graphics Division  
215 MOFFETT PARK DRIVE  
SUNNYVALE, CALIFORNIA 94086

or use Comment Sheet in the back of this manual

# LIST OF EFFECTIVE PAGES

New features, as well as changes, deletions, and additions to information in this manual are indicated by bars in the margins or by a dot near the page number if the entire page is affected. A bar by the page number indicates pagination rather than content has changed.

<u>Page</u>	<u>Revision</u>
Front Cover	-
Title Page	G
ii	G
iii/iv	G
v	G
vi	G
vii	G
viii	G
1-1	G
1-2	B
1-3	G
1-4	B
1-5 thru 1-20	G
2-1 thru 2-37	G
3-1	G
3-2	G
3-3	B
3-4 thru 3-7	G
4-1	D
A-1 thru A-41	G
B-1	G
B-2	F
B-3	C
B-4	F
B-5	D
B-6	C
B-7	G
B-8	D
B-9	F
B-10	C
B-11	D
B-12	D
C-1 thru C-9	G
D-1 thru D-3	G
E-1	G
F-1	G
G-1 thru G-4	G
H-1 thru H-3	G
Index-1	G
Index-2	G
Comment Sheet	G
Mailer	-
Back Cover	-



# PREFACE

This manual is intended to provide overview information concerning the role of the CDC® Communications Control Program Version 3.4 (CCP) in network processing, and to describe the functions which CCP provides for the network.

[ ] Square brackets enclose entities that are optional; if omission of any entity causes the use of a default entity, the default is underlined.

{ } Braces enclose entities from which one must be chosen.

## CONVENTIONS USED

Throughout this manual, the following conventions are used in the presentation of statement formats, operator type-ins, and diagnostic messages:

- ALN Uppercase letters indicate words, acronyms, or mnemonics either required by the network software as input to it, or produced as output.
- aln Lowercase letters identify variables for which values are supplied by NAM or the terminal user, or by the network software as output.
- ... Ellipsis indicates that the omitted entities repeat the form and function of the entity last given.

Unless otherwise specified, all references to numbers are to decimal values; all references to bytes are to 8-bit bytes; all references to characters are to 8-bit ASCII coded characters.

## RELATED MANUALS

The manuals listed below contain additional information on both the hardware and software elements of the CONTROL DATA® 255x Series Computer Systems and the CCP and related software. The Software Publications Release History serves as a guide in determining which revision level of software documentation corresponds to the Programming Systems Report (PSR) level of installed site software.

<u>Publication</u>	<u>Publication Number</u>
<b>Host Manuals</b>	
Network Products Communications Control Program Version 3 System Programmer's Reference Manual	60474500
Network Products Interactive Facility Version 1 Reference Manual	60455250
Network Products Network Access Methods Version 1 Reference Manual	60499500
Network Products Network Access Methods Version 1 Network Definition Language Reference Manual	60480000
Network Products Remote Batch Facility Version 1 Reference Manual	60499600
Network Products Stimulator Version 1 Reference Manual	60480500
Network Products Transaction Facility Version 1 Reference Manual	60455340
NOS Version 1 Operator's Guide	60435600
NOS Version 1 Reference Manual, Volume 1 of 2	60435400
NOS Version 1 Reference Manual, Volume 2 of 2	60445300
Software Publications Release History	60481000

### Language Manuals

CYBER Cross System Version 1 Build Utilities Reference Manual	60471200
CYBER Cross System Version 1 Macro Assembler Reference Manual	96836500
CYBER Cross System Version 1 Micro Assembler Reference Manual	96836400
CYBER Cross System Version 1 PASCAL Compiler Reference Manual	96836100
State Programming Language Reference Manual	60472200
Update Version 1 Reference Manual	60449900

### NPU Manuals

MSMP Diagnostic Reference Manual	96700000
Network Processing Unit (NPU) Hardware Reference Manual	60472800
Operational Diagnostic System (ODS) Version 2 Reference Manual	96768410

CDC manuals can be ordered from Control Data Corporation, Literature and Distribution Services, 308 North Dale Street, St. Paul, Minnesota 55103.

This product is intended for use only as described in this document. Control Data cannot be responsible for the proper functioning of undescribed features or parameters.

# CONTENTS

<p><b>1. INTRODUCTION TO CCP AND NETWORK CONCEPTS</b> 1-1</p> <p>Network Concepts 1-1</p> <p>Communications Network Overview 1-1</p> <p>Computer Network Overview 1-1</p> <p>Computer Network Products 1-2</p> <p style="padding-left: 20px;">Network Host Products 1-2</p> <p style="padding-left: 40px;">Network Access Method 1-2</p> <p style="padding-left: 40px;">Network Definition 1-3</p> <p style="padding-left: 40px;">Network Supervision 1-4</p> <p style="padding-left: 40px;">NAM Applications Programs 1-4</p> <p>Communications Network Products 1-6</p> <p style="padding-left: 20px;">255X Series NPU 1-6</p> <p style="padding-left: 20px;">Communications Control Program 1-7</p> <p style="padding-left: 40px;">CCP Coding Languages 1-7</p> <p style="padding-left: 40px;">Message Movement in a Network 1-7</p> <p style="padding-left: 40px;">Simplified Input Message Processing 1-7</p> <p style="padding-left: 40px;">Simplified Output Message Processing 1-8</p> <p style="padding-left: 40px;">CCP Role in Network Processing 1-9</p> <p style="padding-left: 40px;">Multiplexing Operation 1-10</p> <p style="padding-left: 40px;">Base System Software 1-10</p> <p style="padding-left: 40px;">Block Interface Package (BIP) 1-11</p> <p style="padding-left: 40px;">Host Interface Package 1-11</p> <p style="padding-left: 40px;">Link Interface Package 1-12</p> <p style="padding-left: 40px;">Terminal Interface Packages 1-13</p> <p style="padding-left: 40px;">CCP Software Languages 1-15</p> <p style="padding-left: 20px;">255X Hardware 1-17</p> <p style="padding-left: 40px;">Communications Processor 1-17</p> <p style="padding-left: 40px;">Multiplex Subsystem 1-18</p> <p style="padding-left: 40px;">Communications Console 1-19</p> <p style="padding-left: 40px;">2558-3 Channel Coupler 1-19</p> <p style="padding-left: 40px;">Communications Line Adapters 1-19</p> <p style="padding-left: 40px;">2560 Series Synchronous Communications</p> <p style="padding-left: 60px;">Line Adapters 1-19</p> <p style="padding-left: 60px;">Sample Configurations 1-19</p> <p style="padding-left: 60px;">Terminals Supported 1-19</p> <p><b>2. OVERVIEW OF CCP FUNCTIONS</b> 2-1</p> <p>Multiplexing, Switching and Data Conversion 2-1</p> <p>Interfaces 2-3</p> <p>Transmission Media 2-3</p> <p>Initialization 2-4</p> <p>Base System Software 2-5</p> <p style="padding-left: 20px;">System Monitor 2-5</p> <p style="padding-left: 20px;">Buffer Handling 2-5</p> <p style="padding-left: 20px;">Worklist Services 2-5</p> <p style="padding-left: 20px;">Queuing Mechanisms 2-6</p> <p style="padding-left: 20px;">Direct Program Calls (Switching Services) 2-6</p> <p style="padding-left: 20px;">Interrupt Handling 2-6</p> <p style="padding-left: 20px;">Timing Services 2-6</p> <p style="padding-left: 20px;">Globals 2-7</p> <p style="padding-left: 20px;">Control Block Services 2-7</p> <p style="padding-left: 20px;">Directory Maintenance 2-7</p> <p style="padding-left: 20px;">Standard Subroutines 2-7</p> <p style="padding-left: 20px;">Multiplex Subsystem Operation 2-7</p> <p style="padding-left: 40px;">Input Multiplexing 2-7</p> <p style="padding-left: 40px;">Output Multiplexing 2-7</p> <p style="padding-left: 40px;">Trunk Multiplexing 2-7</p> <p style="padding-left: 40px;">Demultiplexing 2-8</p> <p>Block Interface Package (BIP) 2-8</p> <p style="padding-left: 20px;">Block Routing 2-9</p> <p style="padding-left: 20px;">Service Module 2-9</p> <p style="padding-left: 20px;">Interactive Virtual Terminal Commands 2-9</p>	<p>Batch Terminal PRU Commands 2-9</p> <p>Routing 2-9</p> <p>Block Acknowledgment and Data Flow Control 2-9</p> <p>Processing Special Characters and IVT Commands 2-9</p> <p>Processing Autoinput 2-9</p> <p>Common TIP Subroutines 2-9</p> <p>Failure and Recovery 2-10</p> <p style="padding-left: 20px;">Host Failure 2-10</p> <p style="padding-left: 20px;">NPU Failure 2-10</p> <p style="padding-left: 20px;">Logical Link Failure 2-10</p> <p style="padding-left: 20px;">Trunk Failure 2-10</p> <p style="padding-left: 20px;">Line Failure 2-10</p> <p style="padding-left: 20px;">Terminal Failure 2-10</p> <p style="padding-left: 20px;">Diagnostics 2-10</p> <p>Interface Packages 2-10</p> <p style="padding-left: 20px;">Hardware Used by Interface Packages 2-11</p> <p style="padding-left: 20px;">Software Used by Interface Packages 2-11</p> <p>Host Interface Package 2-11</p> <p style="padding-left: 20px;">Micromemory Start and Stop Commands 2-12</p> <p style="padding-left: 20px;">Control Word Transfers 2-12</p> <p style="padding-left: 20px;">Status Word Transfers 2-18</p> <p style="padding-left: 20px;">Data Transfers 2-18</p> <p>Link Interface Package 2-18</p> <p style="padding-left: 20px;">Loading/Dumping of Remote NPU 2-19</p> <p style="padding-left: 20px;">Trunk Transmission Priorities and Regulation 2-19</p> <p style="padding-left: 20px;">Transmission Assurance 2-19</p> <p>Terminal Interface Packages 2-19</p> <p>Async TIP 2-20</p> <p style="padding-left: 20px;">Input Processing 2-20</p> <p style="padding-left: 20px;">Output Processing 2-21</p> <p style="padding-left: 20px;">User Interface 2-21</p> <p>MODE 4 TIP 2-21</p> <p style="padding-left: 20px;">Mode 4 Autorecognition 2-22</p> <p style="padding-left: 20px;">Mode 4 Data Handling 2-22</p> <p style="padding-left: 20px;">Host Interface 2-22</p> <p style="padding-left: 20px;">IVT Interface 2-22</p> <p style="padding-left: 20px;">Card Reader Interface 2-23</p> <p style="padding-left: 20px;">Printer Interface 2-24</p> <p>Binary Synchronous Communications (BSC) TIP 2-24</p> <p style="padding-left: 20px;">Terminal Device Selection 2-24</p> <p style="padding-left: 20px;">Batch Input Characteristics of 2780 and 3780 Terminals 2-25</p> <p style="padding-left: 20px;">Batch Output Characteristics of 2780 and 3780 Terminals 2-25</p> <p style="padding-left: 20px;">Interactive Input and Output Mode 2-26</p> <p style="padding-left: 20px;">Autorecognition 2-27</p> <p style="padding-left: 20px;">IVT Commands 2-27</p> <p>HASP Multileaving TIP 2-27</p> <p style="padding-left: 20px;">Summary of HASP Protocol 2-27</p> <p style="padding-left: 20px;">Protocol Operation 2-28</p> <p style="padding-left: 20px;">Control Blocks 2-28</p> <p style="padding-left: 20px;">Data Blocks 2-28</p> <p style="padding-left: 20px;">Error Handling 2-28</p> <p style="padding-left: 20px;">Data Conversion 2-28</p> <p style="padding-left: 20px;">HASP Input Batch Data 2-28</p> <p style="padding-left: 20px;">HASP Printer Output Data 2-29</p> <p style="padding-left: 20px;">HASP Card Punch Output Data 2-30</p> <p style="padding-left: 20px;">HASP Plotter Output Data 2-30</p> <p style="padding-left: 20px;">HASP Error Recovery Procedures 2-30</p> <p style="padding-left: 20px;">HASP Terminal Start-up and Termination 2-30</p> <p>X.25 TIP/PAD SubTIP 2-30</p> <p style="padding-left: 20px;">X.25 Input Sequence 2-31</p> <p style="padding-left: 20px;">X.25 Output Sequence 2-31</p> <p style="padding-left: 20px;">Supported Terminal Classes 2-32</p>
--	---

Transparent Mode	2-32
Autoinput	2-32
Parity	2-32
Typeahead Input from the Terminal	2-32
Block Mode	2-32
Backspacing from the Terminal	2-32
Cancel Input	2-33
Break Key Processing	2-33
Formatting on Output	2-33
IVT Commands	2-33
Build-Time Selections	2-33
Message Priorities and Input Regulation	2-33
Message Priorities	2-33
Input Regulation	2-35
Host Interface Regulation	2-35
Trunk Interface Regulation	2-35
Terminal Interface Regulation	2-35
Logical Link Regulation	2-36
Upline Data	2-36
Downline Data	2-37
3. INITIALIZING THE NPU	3-1
Load/Dump Phases for Local NPUs	3-1
Local NPU Loading	3-1
Load File Format	3-1
Local NPU Dumping, 2551 NPU	3-2
Remote NPU Loading	3-2
Remote NPU Dumping	3-6
Configuring NPUs	3-7
4. FAILURE, RECOVERY, AND DIAGNOSTICS	4-1

## APPENDIXES

A Coded Character Data Input, Output, and Central Memory Representation	A-1
B Diagnostics	B-1
C Glossary	C-1
D CCP Mnemonics	D-1
E Sample Main Memory Map for NPU	E-1
F CCP Naming Conventions	F-1
G Terminal Commands and Messages	G-1
H NPU Operating Instructions	H-1

## INDEX

### FIGURES

1-1	CYBER Network, Overview of Functions	1-2
1-2	Network Host Products	1-3
1-3	Network Supervisor Functions	1-5
1-4	Communications Supervisor Functions	1-6
1-5	Simplified Input Message Processing	1-8
1-6	Simplified Output Message Processing	1-9
1-7	CCP Software Levels	1-11
1-8	Sample NPU/Peripheral Hardware Configurations	1-20
2-1	Simplified NPU Buffered Transfers	2-1
2-2	Base Elements of the Multiplex Subsystem	2-8
2-3	Functions of a LIP	2-11
2-4	Functions of a TIP (not X.25 TIP)	2-12
2-5	Comparison of TIP/LIP and X.25 TIP Functions	2-12
2-6	Sample Logical Link Connections (Shown for Local and Remote NPUs)	2-37
2-7	Buffer Availability Threshold Levels for Regulation	2-37
3-1	Load File Format	3-3
3-2	Format of 2551 Dump	3-4
3-3	Format of Words in Dumps	3-4

### TABLES

2-1	Buffer Assignment/Release in NPU	2-2
2-2	Interface/Protocol Relationships	2-3
2-3	Hardware Used by Interface Packages	2-13
2-4	Interface Package Software Characteristics	2-14
2-5	Mode 4 Components	2-21
2-6	Mode 4 Terminology	2-21
2-7	X.25/PAD TIP and PDN Transfer Characteristics	2-31
2-8	X.25/PAD SubTIP Terminal Classes	2-32
2-9	Parity Actions	2-32
2-10	CCITT PAD Parameters and Recommended Settings	2-34
2-11	Regulation	2-36
3-1	Load/Dump Phases	3-1



The Communications Control Program (CCP) provides the software necessary to process data (messages) through the network communications portion of a Control Data Network. As will be described later in greater detail, the network communications function allows an applications program in the main computer (a CYBER 70/170, called the host computer in a network) to process data as if the program were attached directly to a virtual terminal connected directly to a CYBER port. Since virtual terminals can be of only two types, interactive or batch, the host processing becomes essentially independent of terminal type.

Minimizing terminal type dependency, as well as removing many of the terminal switching operations from the host, frees the CYBER computer to process data efficiently in the manner in which it was designed: as a high-speed, high-powered processor. As a result of this division of labor, the host can accommodate many more terminals, terminal types, and applications programs. Naturally, the host also processes applications programs more rapidly and with greater flexibility since it is not burdened with I/O functions that are better performed elsewhere.

The network communications function, thus removed from the CYBER computer, is made resident in the Network Processing Unit (NPU). The NPU is a minicomputer system resident in a 255x Host Communications Processor and its associated multiplexing and coupling hardware. The types of operations performed by the NPU are:

- multiplexing data to/from the numerous terminals
- demultiplexing data and storing it in buffers for buffered high-speed transfers to/from the host computer
- converting the numerous terminal protocols into either an interactive or a batch virtual terminal protocol; the converse operation is performed for output operations to terminals
- regulation of the volume of traffic handled

Communications network processing not only relieves the host computer of most I/O overhead; it also relieves applications programmers of the need to concern themselves with terminal characteristics other than the characteristics of the virtual terminals.

Since it is necessary to know the basic concepts of network message processing to understand the structure of the CCP software, this introduction includes a description of the network and the distribution of network tasks between the host and the NPUs.

The CCP is itself functionally divided into three software groups:

- base system software which includes the NPU operating system: monitor, timing and interrupt services, initialization, space allocation, and other general service routines; the multiplexing subsystem is also a part of the base system software
- block interface package (BIP) software: block formation (PRU or IVT), routing, control and status processing, hardware configuration control
- other interface packages: the host interface, the link interface to a remote NPU (if one exists in the network), and the standard terminal interfaces (ASYNC, BSC, HASP, Mode 4, X.25 with PAD SUBTIP)

## NETWORK CONCEPTS

Network products provide effective data-processing services to terminal users. These services consist primarily of applications programs written to perform specific functions. The applications programs are executed in the host computer.

Network products are designed to achieve functional separation between the host system services to terminal users, and the communications equipment software required to interconnect the host computer and its terminals. This has led to the concept of viewing the complete network as consisting of two separate networks, a communications network and a computer network, with well-defined hardware and software boundaries between them as shown in figure 1-1.

## COMMUNICATIONS NETWORK OVERVIEW

The communications network includes a set of Network Processing Units (NPUs) interconnected by communications lines. Its purpose is to transport blocks of data between the host computer and terminals. To perform this function, the NPU presents an interface (represented by a set of protocols) to the host computer on the one side and to each terminal on the other side. Messages are carried in buffers of data and are transferred to/from the host at channel speeds. At the terminal interface, messages are transferred one character at a time at communications line speeds.

The host interface is insensitive to the detailed topology of the communications network, so that the network may be either a simple network with a single local NPU or a network with one local NPU and one or more remote NPUs.

## COMPUTER NETWORK OVERVIEW

The computer network includes host computers and terminals, the host software associated with network communications, and the applications programs providing services to

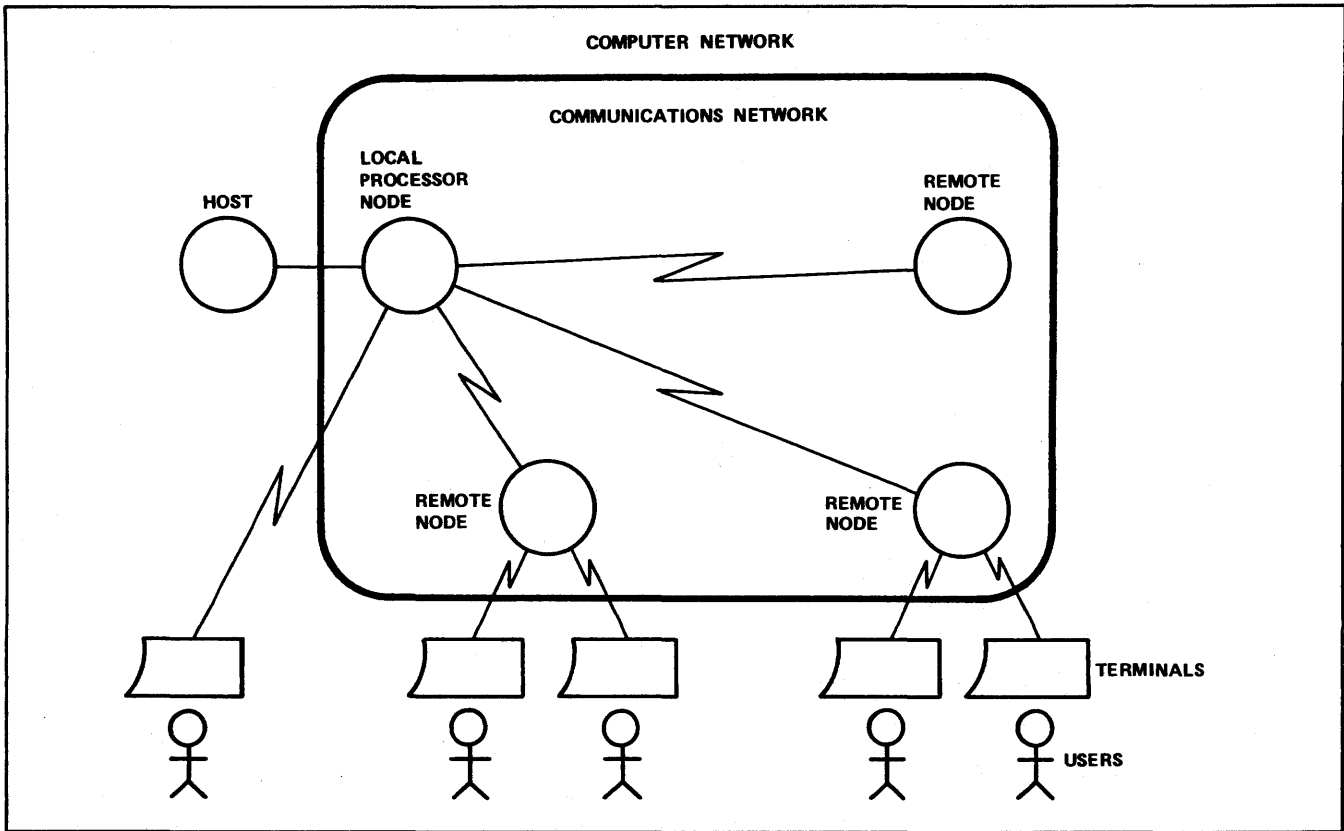

Figure 1-1. CYBER Network, Overview of Functions

the terminal users. The software in each host computer meets the interface presented by the communications network on the one side, and in turn presents a standard interface to applications programs written to use the network on the other side. In this way, the communications network is isolated from the applications programs so that it may be changed without disturbing the applications-level software.

## COMPUTER NETWORK PRODUCTS

The computer network uses the communications network along with host computer software and possibly terminal software to interface between terminal users and applications programs in a host computer system.

The major network host product is the Network Access Method (NAM). Other network host products which execute as applications to NAM provide standard support of time-sharing, remote batch handling, and transaction processing for the terminal user.

### NETWORK HOST PRODUCTS

The CYBER Network Operating System (NOS) provides the operational environment and control for the computer network software. The Network Access Method (NAM) provides a standard interface between the communications network and the applications programs executing in the host.

The remaining network host products execute as network applications programs in the host; all use NAM to communicate with the communications network and with each other.

The network and communications supervisors are responsible for the network coordination and control-oriented activities of the CYBER host computer.

Standard NAM applications programs are provided to support various user applications environments such as timesharing, remote batch and transaction processing. User-provided applications may be added to meet special requirements.

### Network Access Method

The Network Access Method (NAM) provides a generalized method for CYBER applications programs to access the communications network. Figure 1-2 illustrates this relationship.

NAM provides a centralized queuing mechanism for accessing the communications network and a subroutine package that resides in each network applications program's field length. This subroutine package allows the applications to interface to NAM with CALL/ENTER-type procedure statements.

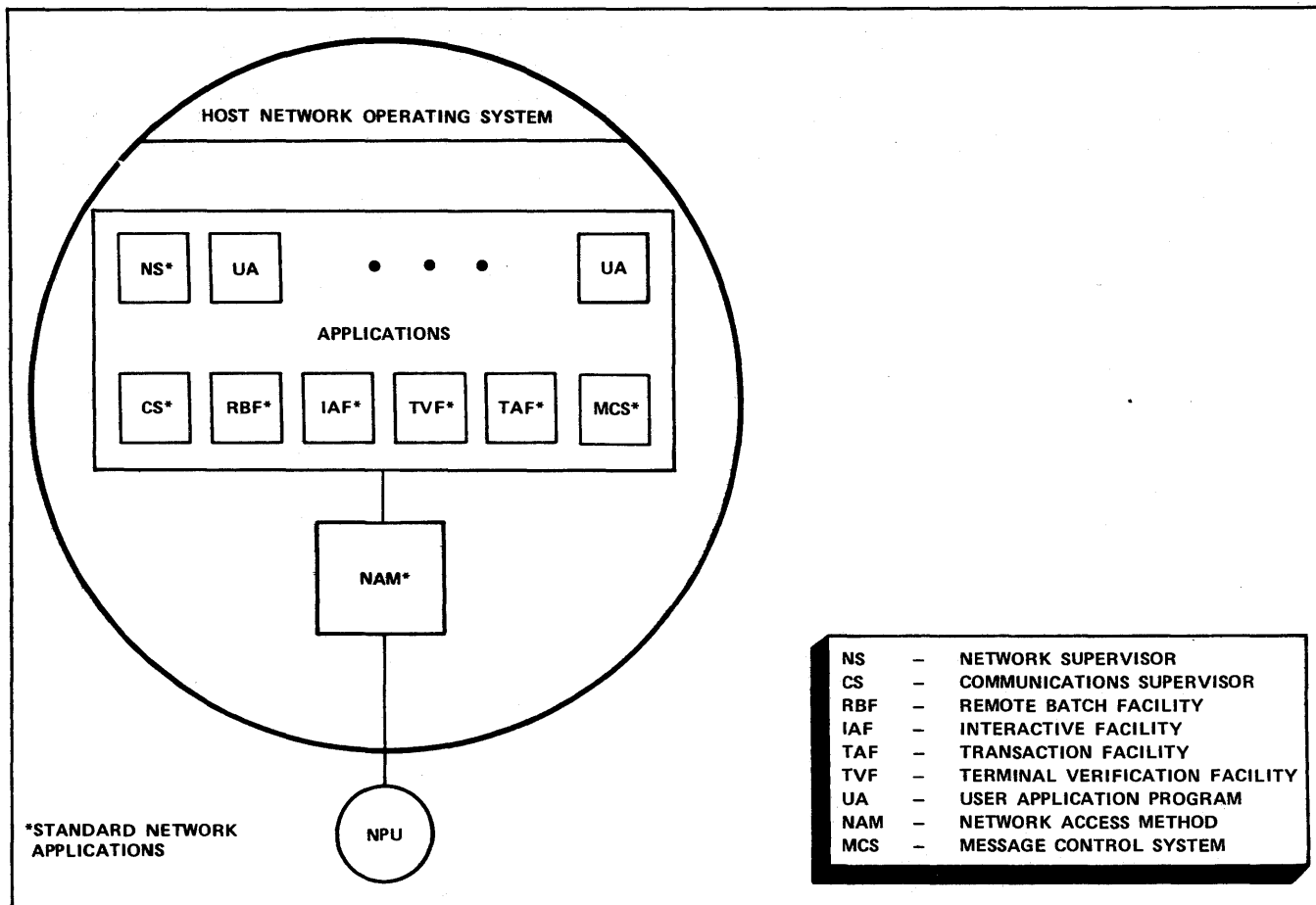

Figure 1-2. Network Host Products

Procedure statements are provided so that the applications program can connect to and disconnect from NAM, and can perform functions for applications programs similar to the LOGIN and LOGOUT procedures provided for users at terminals. They allow the installation to control the access to the communications network for programs executing in the host computer. Procedure statements also control the data exchange between the applications program and NAM buffers. Each applications program may have a number of logical connections. Each logical connection is associated with a single terminal or with another applications program. For each logical connection, NAM maintains a set of control tables and buffers. These allow NAM to queue data between the connected terminal and the associated applications program. NAM itself actually performs the physical I/O with the communications network.

As various events occur in the network, supervisory messages are passed to the applications program. They may, for example, inform the applications program of a new logical connection for a terminal which desires service from it, or of the fact that some failure has occurred. In the same way, the applications program uses supervisory messages to communicate with NAM. For example, an applications program may wish to disassociate itself from some terminal with which it has a logical connection.

This use of supervisory messages between NAM and the applications program obviates the necessity for a defined table structure in the applications program's field length. NAM allows the applications program to use the table structure that is most efficient for it. Additionally, NAM does not limit the kind of buffering used by the applications program. The applications program may provide a buffer for each logical connection; alternatively, it may perform all its I/O from a single buffer. This allows the applications programmer maximum flexibility in the design of his program. NAM is described in detail in the NAM Reference Manual.

#### Network Definition

The CYBER 170 Network Products define the complete network:

- The communications network is defined in terms of hosts and nodes and the physical/logical links between them.
- The computer network is defined in terms of applications programs, lines and terminals.

Network definition is provided by a language called the network definition language (NDL) which consists of a series of statements that describe the network. These statements generate a network configuration file (NCF), a local configuration file (LCF) and a printed output. NCF and LCF are used by the network host products in establishing, initiating, operating and controlling the network. The printed output provides documentation of the network configuration. NDL is described in detail in the NDL Reference Manual.

### Network Supervision

The following paragraphs describe the network supervisor and the communications supervisor.

### NETWORK SUPERVISOR

The network supervisor (NS) coordinates the activities of the various network processing units (NPUs) in the communications network.

The network supervisor functions are as follows (see figure 1-3):

- NS is responsible for loading software into the NPUs.
- NS superimposes a logical network structure on the physical structure of the communications network. Logical links are established between the host and each NPU with which it is allowed to communicate. Note, however, that the host communicates with remote NPUs only through the local NPU. This minimizes the number of host programs that are aware of the physical structure of the network. The host can treat the entire communications network as a set of front-end NPUs; only NS tracks the actual physical topology of the network. By this means, the functions of the computer network and the communications network are effectively separated.
- NS also receives reports from the NPUs on the status of the network. The supervisor takes corrective action as required. NS operates from a data base established by the individual responsible for managing the communications network, the network operator. This person prepares two files for use by NS. One contains copies of the software for each NPU in the network. The second contains a description of the configuration of the network. This latter file is prepared using network definition language. NS also allows the network operator (NOP) to control and to take the status of the communications network, either from a terminal in the network or from the CYBER 170 network operator's console. NS is described in detail in the NOS Operator's Guide.

### COMMUNICATIONS SUPERVISOR

The communications supervisor (CS) coordinates the network-oriented activities of the host computer.

CS operates from a data base established by the individual responsible for managing the host's use of the communications network, the local operator (LOP). The local

configuration table created by the NDL contains terminal information which allows CS to establish the physical configuration and characteristics of the terminals for which its host is responsible. CS also allows the local operator to control and to take the status of his portion of the computer network, either from a terminal in the network or from the LOP's console.

The primary function of CS is to isolate the applications programs from the physical configuration of the terminals in the network. As applications programs make themselves known to NAM and as terminals connect to the network, CS establishes logical connections between terminal and program as shown in figure 1-4.

Applications programs communicate with terminals using simple connection numbers irrespective of the location of the terminals in the network. Logical connections may also exist between different applications programs.

The network definition language (NDL) allows various options on the establishment of logical connections.

- A terminal may be automatically connected to a given application.
- The user at the terminal may be allowed to select the application he requires.
- The user may be required to log-in before he is allowed to access the host computer.

CS use is described in detail in the NOS Operator's Guide.

### NAM Applications Programs

NAM applications programs provide users with communications access to host-system resources that satisfy a variety of processing needs.

### REMOTE BATCH FACILITY

The remote batch facility (RBF) provides the capability to transfer data between files on a CYBER 170 host-computer and batch peripherals on terminals in the network. RBF interfaces to the Network Access Method (NAM) in order to communicate with its terminals. RBF is described in detail in the RBF Reference Manual.

### INTERACTIVE FACILITY

The interactive facility (IAF) provides the terminal user with a range of timesharing capabilities. The facility provides the illusion to the user that he is the only user of the system. IAF also maintains control of files created by the user. Files are presumed private to the user who created them but can be declared to be common so other users may access them. Programs may be debugged interactively by use of IAF. The IAF Reference Manual gives a detailed description of IAF capabilities.

### TRANSACTION FACILITY

The transaction facility (TAF) enables the terminal user to request a host system to perform a series of pre-defined tasks, such as checking a customer's credit and recording a sale, or making a reservation, or recording a deposit/withdrawal/loan payment at a bank. When a transaction has

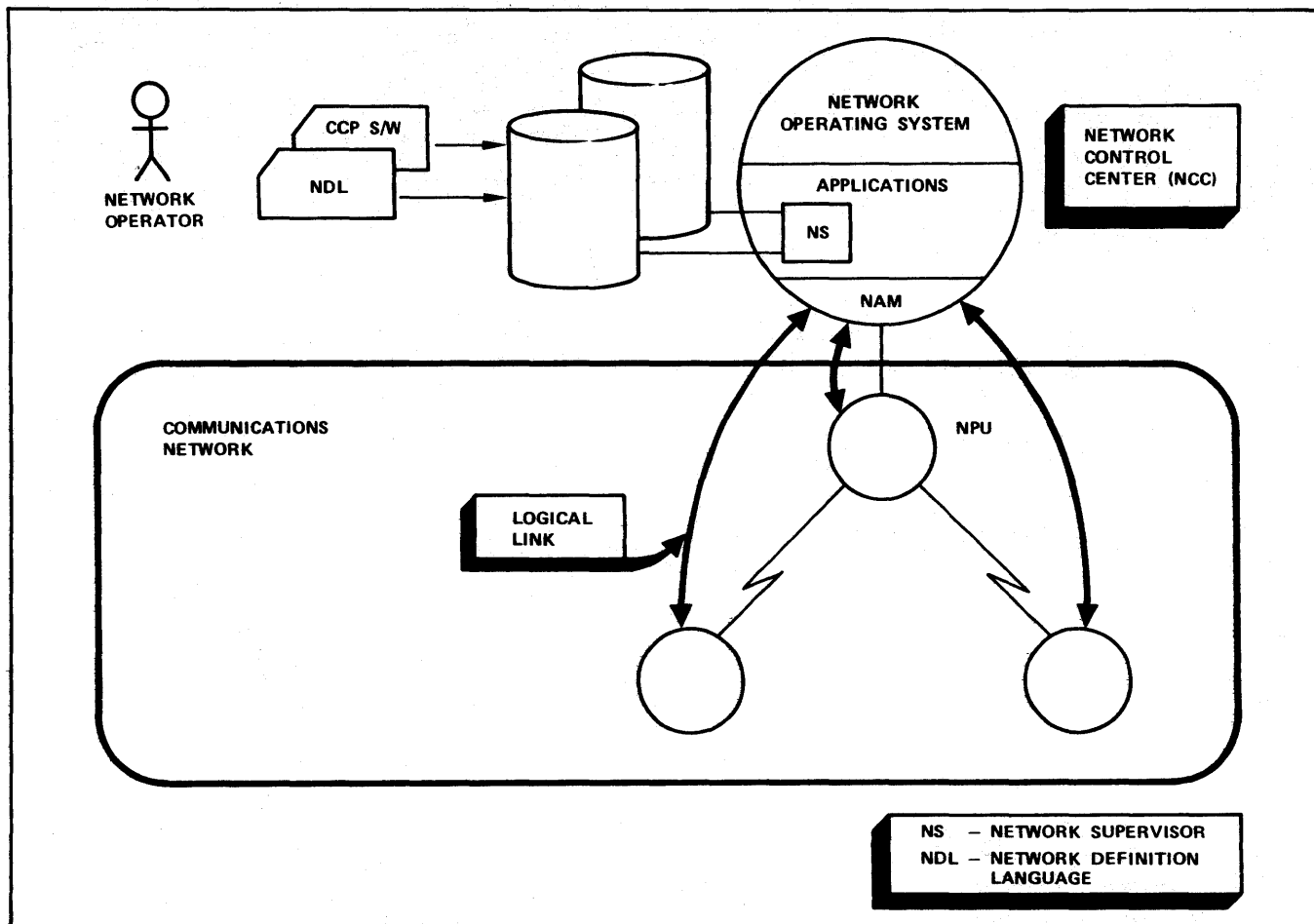

Figure 1-3. Network Supervisor Functions

been processed, information (such as status, acknowledgment, or verification) is returned to the originator. Each subscriber has a private data base. The subsystem can contain a specialized data manager for use by the tasks or the total extended data base management system can be used. TAF is described in detail in the TAF Reference Manual.

#### NETWORK VALIDATION FACILITY

The network validation facility (NVF) protects user applications, and such applications as RBF, IAF, TVF, or TAF, against unauthorized access by terminal users. NVF validates each user before granting access to the computer system or any of its resources.

Validation is based on access permissions defined in a protected file. Statistical information and thresholds for illegal conditions pertaining to log-on and application requests are maintained, logged and reported for accounting and security (that is, penetration-detection) purposes.

#### TERMINAL VERIFICATION FACILITY

The terminal verification facility (TVF) provides the user with an active confidence test (diagnostic) to verify the correct operation of his terminal. This is accomplished by sending data to or from the terminal in either a user-defined or TVF-selected format. Three tests are provided:

- A loopback test sends data entered by the user back to the terminal.
- A line test sends one full line of data to the user.
- A screen test sends one full screen of data to the user.

TVF is described in detail in the NAM Reference Manual.

#### MESSAGE CONTROL SYSTEM

The message control system (MCS) allows the user to queue, route, and journal messages between COBOL programs and terminals. By using the Application Definition Language, an MCS application can be tailored to fit a user's needs. The terminal can be switched from MCS to NVF.

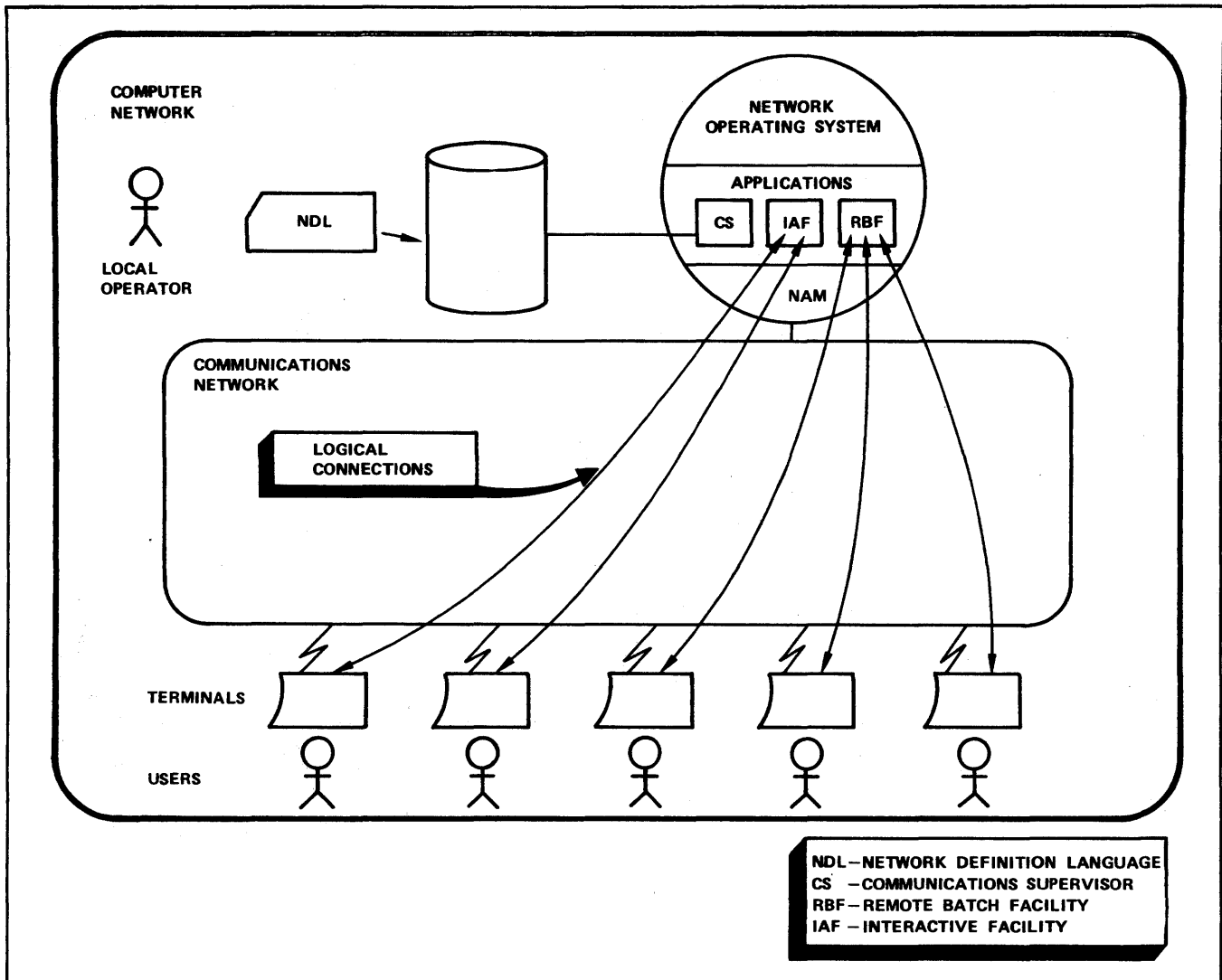

Figure 1-4. Communications Supervisor Functions

## COMMUNICATIONS NETWORK PRODUCTS

The communications network allows terminals to access the host computer via communications lines. The network products used to implement this access are:

- 255x series Network Processing Unit (NPU) hardware which provides for physical connection between host and terminal. In CCP two variations are possible: local NPUs or local and remote NPUs.
- Communications Control Program (CCP) which is the software system in the 255x series NPU
- Cross System software which supports the installation, maintenance and modification of CCP via the CYBER host computer. This is a batch-oriented compiler/run-time system.

## 255x SERIES NPU

The hardware portion of the communications network consists of:

- A microprogrammable, 16-bit processor (mini-computer). Main memory contains all the space necessary to execute programs and to provide buffers for network data. External (mass) memory is not used.
- A CYBER channel coupler which provides the high-speed interface between the minicomputer and the host's Peripheral Processing Unit (PPU). Transfers over this channel are buffered.

Channel buffers within the NPU provide enough space to handle an entire message transfer in a single operation.

#### NOTE

The host/NPU coupler interface passes data upline to the host in one of three formats: interactive virtual terminal for interactive devices, physical record unit (PRU) for batch devices, or transparent. Blocks are received from the host in the same formats.

- A multiplex subsystem consisting of:
  - A Multiplex Loop Interface Adapter (MLIA) which controls the input and output multiplex loops
  - Individual loop multiplexers (LMs) which attach to the input and output multiplex loop on one side and to individual Communications Line Adapters (CLAs) on the other. The CLAs provide line-by-line interface compatibility with the modems attached to terminals or to remote NPUs.

#### NOTE

At the interface of the NPU to the lines, data passes to/from the terminals in a format (protocol) compatible to the terminal. A remote NPU is treated as a special type of terminal.

### COMMUNICATIONS CONTROL PROGRAM

The three major parts of the Communications Control Program (CCP) are:

- The base system which includes the OPS-monitor, interrupt handlers, multiplex subsystem, software and firmware, timing services, initialization (the NPU is downline-loaded from the host), space allocation, program-to-program calls and data transfers, standard subroutines, text processing, and error checking.
- Block interface package (BIP) software, which provides block formation (PRU or IVT), routing, control and status processing, and hardware configuration control.

#### NOTE

Inline diagnostics are provided as part of CCP. If the customer elects to purchase a CDC maintenance contract, on-line diagnostics are provided. Also provided in the maintenance program are some host-based applications programs which simplify the use of inline diagnostics.

- Interface software. Three standard types of interfaces are provided:
  - Host interface package (HIP) supports the high-speed, buffered channel interface to the host computer. Data is assumed to be in IVT or PRU format.

- Link interface package (LIP) supports the local/remote NPU transfers. The remote NPU collects data from its terminals and formats it prior to passing the data upline to a local NPU. This interface uses the CDC Communications Procedure (CDCCP) protocol.
- Terminal interface packages (TIPs). Five standard TIPs handle transfers for terminals using interactive modes (ASYN or X25 with PAD subTIP), or both batch and interactive modes (Mode 4, BSC, and HASP).

### CCP Coding Languages

For ease in programming the NPU, the programmer can code his source language routines in PASCAL, an ALGOL-like language. The Cross system programs are run on the host, and the principal output is an NPU machine language load file which resides in host mass storage. This load file contains all of the CCP modules in NPU image format (including overlays). This file is used to load the NPU (remote or local) following an NPU or host failure. The Cross system is described at the end of this section.

A few common programs are coded in the macro assembler language. A special subset of this language, called state programs, uses a set of specially-defined macrocommands to process messages on the microprocessing level. Each TIP contains message conversion programs written in the state programming language. All programs, regardless of source language, are included in the host's load file.

### Message Movement in a Network

The basic procedures for upline and downline message movement are discussed next. Note that the procedures given are highly summarized. Acknowledgment procedures are also highly summarized. It is assumed that terminals are connected through a single NPU.

### Simplified Input Message Processing

Figure 1-5 shows the movement of a message from a terminal to the host applications program. Solid lines indicate message (and acknowledgment message) pathways, dashed lines indicate principal control functions. The major features of the upline message processing are:

- Some synchronous terminals are polled to find if the terminal has data ready to send; an asynchronous terminal sends data when it is ready
- Setting up of multiplex subsystem and buffers when terminal indicates it has data to send upline
- Collecting all data from this (and all other active terminals) in a circular input buffer (CIB)
- Demultiplexing data and converting it to a host compatible format (IVT or PRU). Demultiplexed data is collected in a block which uses one or more chained buffers and is called a line-related input buffer. If code conversion is necessary (such as EBCDIC to ASCII for interactive data or EBCDIC to display code for batch data), this is also accomplished.
- When input buffer is full (that is, the message is complete), message is validated.

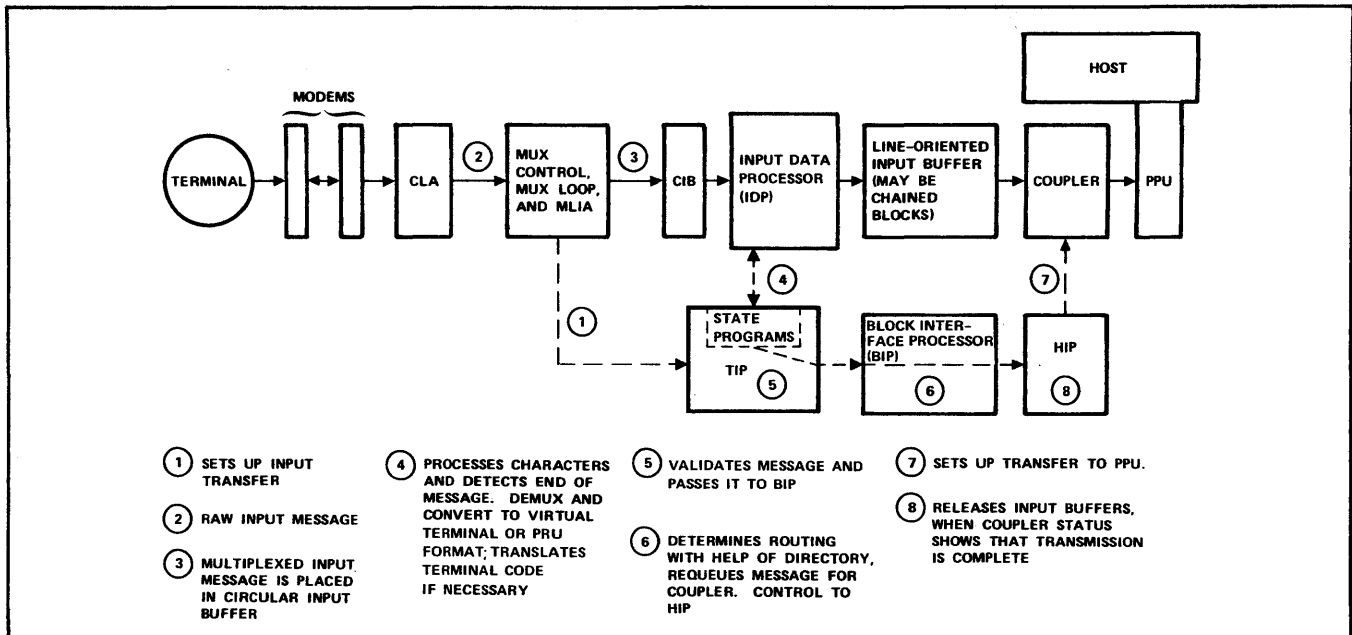

Figure 1-5. Simplified Input Message Processing

- Message routing is determined and message is queued to the host coupler. Statistics (a type of status information that includes both successful and failure information) are generated for the transfer.
- The coupler transmits the message to the host PPU and unqueues the message from the coupler.
- The host receives the message and connects it to the applications program.
- The NPU finishes input processing by releasing the message buffer.
- The message is sent by a buffered transfer from the PPU through the coupler to the assigned buffers. The coupler causes the transmission complete interrupt to the HIP when all of the message has been received.
- The text processor converts the message from IVT or PRU format to the destination terminal's format (transmission blocks).
- The transmission block is queued to a terminal control block where the terminal interface package (TIP) detects that data is available.

### Simplified Output Message Processing

Figure 1-6 shows the movement of a message from a host application program to a terminal (downline messages). Conventions for solid and dashed lines are the same as for the input message diagram. The major features of the downline message processing are:

- **Interrupt from the host indicates a buffer of data (message or file) is ready for transmission. The data is in PRU, IVT, or transparent format at this point.**
- If the NPU is not already saturated with other, higher priority tasks (note that output takes precedence over input), the host interface package (HIP) sets up the coupler to receive the message and assigns a buffer (or chained buffers) of space to be used as an output buffer for the block.
- If the terminal is able to output data, the TIP directs the multiplexer subsystem to output the message.
- When the terminal has detected the end of message, it sends an acknowledgment message.
- Upon receiving acknowledgment that the message was received, the NPU terminates the output operation by sending an acknowledgment to the host and by releasing the output buffers.

Most of the operations mentioned in the input are described in more detail later in this section. Since most of these operations are CCP functions, they are also discussed in general terms, by individual functions, in section 2.



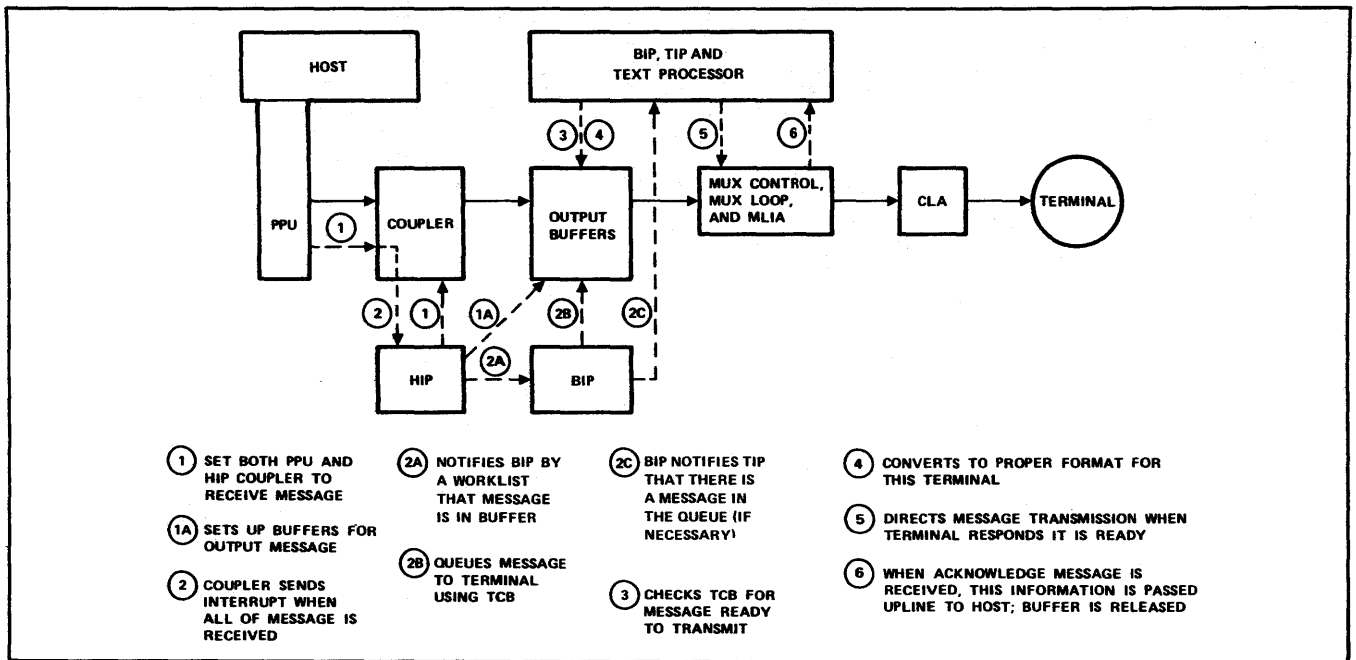

Figure 1-6. Simplified Output Message Processing

#### CCP Role in Network Processing

The CCP must provide the following functions for the network system.

- **Host interface compatibility:** Data is transferred (upline and downline) in high-speed buffered transfers. The data is in PRU, IVT, or transparent format. The host interface package (HIP) monitors this operation.
- Transfers may be regulated; that is, if the NPU is busy with output (downline) processing or has many upline messages already started, new upline transfers may be refused. The rejected transfers will be made at a later time when the NPU is less busy.
- NPU must pass an acknowledgment message to the host after a terminal has received a downline message.
- NPU must prepare the coupler for upline and downline transfers.
- **Conversion:** Non-transparent upline messages are converted from terminal format to IVT format (if the message originated from an interactive terminal) or to PRU format (if the message originated from a batch device). Non-transparent downline messages are converted to the format of the destination terminal. The TIPs contain transform tables for code conversion and some format conversion. The BIP is responsible for some of the format conversion between terminal and IVT or PRU format.

- The CCP must supply memory space in the form of chained input and output buffers.
- Supervision of the multiplex subsystem. On output, supervision consists of preparing the multiplex subsystem to output data from the output buffer. Actual transmission is done on demand from the communications line adapter (CLA). On input this consists of preparing the CLA to receive data. After the data has been placed on the input loop, the multiplex loop interface adapter (MLIA) transfers the data to the circular input buffer (CIB). From the CIB, data must be individually demultiplexed to the line-oriented input buffers.
- If this system has a remote NPU as well as a local NPU, the remote NPU must have a link interface package (LIP) which collects the data and the local NPU must have a LIP for receiving the data. In the remote unit (for upline messages) the data is collected and converted by the appropriate TIP into PRU or IVT format (transparent data is permitted). The completed message is then divided into subblocks of a size suitable for transmitting over the trunk. In the local NPU the subblocks are reconstituted into a message buffer. This data—after validation—is passed to the HIP to be transferred to the host.

The output operation is the converse of the above procedure: that is, blocks of PRU, IVT, or transparent data are broken into subblocks (if necessary), and multiplexed prior to transferring the message over the trunk. Conversion to terminal format takes place in the remote NPU.

Physical placement of the CLA in the NPU cabinet determines the frequency with which the line has access to the multiplex loop. CLAs for lines assigned to trunks are placed in the first slot (or slots) so that these lines have first chance to use the multiplex loop.

- **Terminal interface packages (TIPs) are responsible for setting up the messages so that the terminal protocols for starting, stopping, acknowledging, and message formatting are satisfied. The TIP also converts data from host codes (ASCII for IVT; ASCII or display code for PRU) to the terminal's internal code, if necessary.**

### Multiplexing Operation

The multiplex subsystem has two major functions, both of them hardware related:

- Physical line characteristics vary for the different types of lines. To relieve the TIPs of having to process each line type according to that line's special physical characteristics, the multiplex subsystem handles the characteristics by translating logical line commands/status into physical line command/status. This makes most physical line characteristics transparent to the TIP.
- The high-speed host works most efficiently if given a full block of data to process. A terminal, on the other hand, is often low-speed, and data is transferred to/from the terminal one character at a time. The multiplex subsystem interfaces the high-speed characteristics of the host/NPU with the low-speed characteristics of the lines/terminals.

The multiplex interface to the TIPs is described in the System Programmer's Reference Manual.

### INPUT MULTIPLEXING

Each line has a communications line adapter (CLA). The CLA for each active line is sampled in sequence. If a character is ready, it is placed on the input multiplex loop together with information identifying the source (line) and, in some cases, control information. All input multiplex loop data is routed to a circular input buffer (CIB). The demultiplexing operation picks data from this buffer, reconstructs the messages in data buffers, and passes these buffers to the appropriate processor for this terminal (line).

### OUTPUT MULTIPLEXING

After the NPU has received a full message from the host and the appropriate terminal interface package (TIP) has converted the code to real terminal format, the multiplex subsystem can output the message. The multiplex subsystem picks the characters from the line's output message buffer in response to an output data demand (ODD) generated by the CLA. The ODD signal is the CLA's indication that it is ready to transmit another character. The outgoing characters are placed on the output multiplex loop, along with such control characters as are needed and an address that will be recognized by the CLA connected to that terminal. The CLA for the line picks the data from the output loop via the loop multiplexer. When the contents of the entire output buffer for the line have been transmitted successfully, the message buffers are released. Many output data buffers can be serviced at the same time.

### TRUNK MULTIPLEXING

If a remote NPU is included in the network, transmissions between the local NPU and the remote NPU take place over a trunk. A trunk is a communications line. In the local NPU, a link interface package (LIP) sets up the output buffer. In the remote NPU, the downline messages are treated similarly to upline messages in a local NPU; that is, the message goes through the CIB and is then demultiplexed for the TIP. After the TIP converts the code to terminal format, the message is treated as an output message in a local NPU; that is, the message is transmitted through the multiplex subsystem.

Input messages (upline traffic) are reformatted from terminal to IVT or PRU format as in a local NPU, but are then sent by the LIP through the remote NPU's multiplex subsystem, received by the local NPU's multiplex subsystem, and reconstructed into complete messages in the local NPU by that NPU's LIP.

### DEMULTIPLEXING

The multiplex subsystem is responsible for picking data from the CIB as well as putting it into that buffer. When the message reception starts, the multiplex subsystem firmware reserves a data buffer for the message. The data words for that line are picked from the CIB and are packed into the reserved buffer. Control and tag information is discarded. If a buffer is filled before the message is complete, another buffer is assigned and is chained to the first.

When the end of text is detected, the TIP which is appropriate for the terminal type is called to continue the processing.

The demultiplexing of a downline transfer is a terminal function; that is, the message is reconstructed in a buffer for the screen, printer, or other output device.

### Base System Software

The base system software, which includes the multiplex subsystem, is a basic, relatively invariant, set of CCP programs. As figure 1-7 shows, CCP software belongs to one of three levels:

- base system software
- network communications software
- interface packages (TIPs, LIP, HIP)

The primary functions supplied by the base system are:

- basic operating system functions such as interrupt handling, calling program (queuing requests), allocating space (buffers) to requesting programs, handling the passing of parameters from the calling to the called program (worklist processing), timing services, common areas, and control block services
- some initialization processing
- multiplex subsystem including the command driver which interfaces between the multiplex subsystem (software and hardware) and the TIPs or LIP

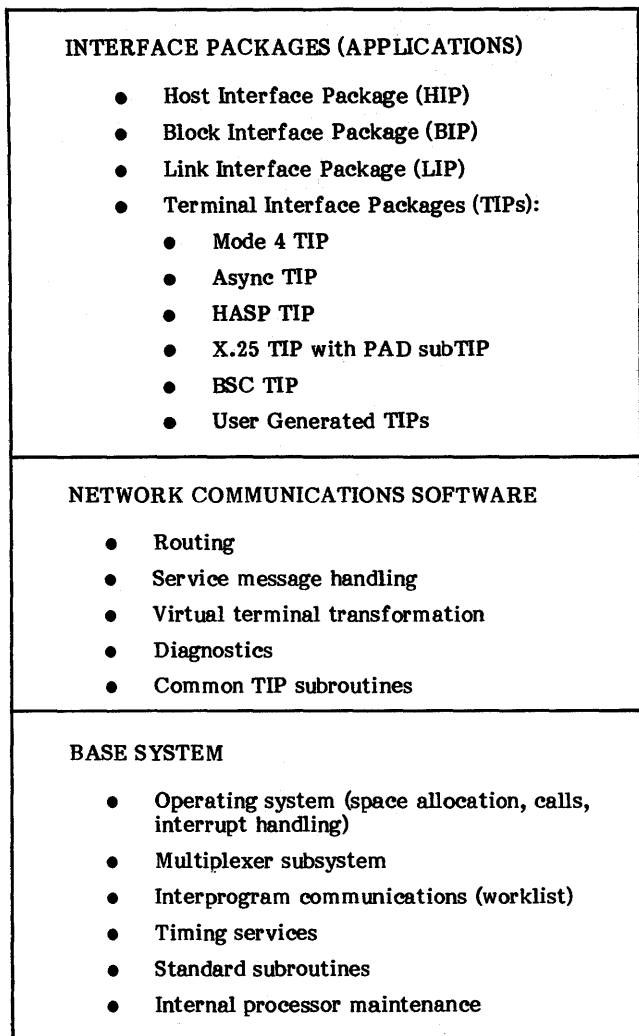

Figure 1-7. CCP Software Levels

- common subroutines such as those for code conversion

Most base subroutines are written in PASCAL language; a few are written in CYBER 18 macro assembler language.

**Block Interface Package (BIP)**

The next level of CCP software is concerned with handling network communications. It provides block switching so that the data block can ultimately be routed downline to the proper terminal, or upline to the host. Data traveling in either direction is tagged with the terminal ID. A group of directories is used to route the block to the next program that must process the block.

Transfer of information (messages or files) through the host/NPU part of the network is accomplished by transmitting the data in blocks (this is called block protocol throughout this manual). A number of block types are defined. Two block types are dedicated to data transfer; the remaining block types contain control information such as acknowledging messages, controlling data flow on a connection, or starting and stopping transmissions.

Conversion to and from IVT or PRU format is done by the BIP and the TIPs. By this means, host applications need expect only three data formats: IVT from any interactive terminal; PRU from any batch device, or transparent data from any terminal so long as either the terminal or the application has specified that the next transmission will be in transparent format.

An option allows data to be passed to/from the host applications program in terminal format. (This is called transparent mode.)

Although the converted data is placed in a new buffer, the block identity is not lost; data blocks remain logically invariant regardless of the number of conversions that occur.

Since the block format itself provides only a limited set of commands, one type of block called a CMD block is dedicated to handling the large number of specific commands needed to set up the connections of the network and to handling data flow over these connections. If the information carried by these command blocks is primarily to establish, change, or delete connections (a process known as configuring the network), the message is called a service message and is handled by the service module. Service messages are used to:

- configure logical links, trunks, lines, and terminals
- command loading or dumping of the NPU
- carry status concerning failure and recovery
- command on-line or inline diagnostics or debugging, or carry information about such processes
- command that a message be broadcast to one terminal or several terminals (including sending a message from a terminal to the network operator's (NOP) or local operator's (LOP) terminal)

**Host Interface Package**

The host interface package (HIP) handles the protocol governing transmissions between the host and the NPU. The route of all such transmissions is through the coupler hardware. Three coupler registers hold status or command information; one register contains the NPU address of the data to be transferred, and one set of lines connects the host PPU buffer to the direct memory access buffer register of the NPU. This set of lines handles all data transfers.

In all cases the format of the byte in the host PPU is 12 bits and the associated half-word (byte) in the NPU is 8 bits. Adjustment is made so that the receiving unit (host or NPU) has an input only as large as its input word or byte size.

Usually, the NPU memory address register is set up by the NPU for upline or downline data transfer. When dumping the contents of the NPU to the host the PPU sets up the register to supply the memory to be dumped.

Four principal functions are performed across the interface.

**MICROMEMORY START AND STOP**

Micromemory start and stop commands are issued by the host. The micromemory must be started at location zero.

## CONTROL WORD TRANSFERS

The NPU sets function commands to the coupler, allowing the coupler to chain buffers of data during transfer, to clear the coupler registers, to read the other status registers, to ready the PPU to read the status registers, and to set the memory address register prior to starting a data transfer.

The PPU sets functions to clear the coupler or NPU, to start or stop the NPU, to input or output a program during the load/dump phase of NPU initialization, to load the memory address for dump operations, and to set or read the other two status-type registers.

## STATUS WORDS

One status word is used for regulation. There are four regulation levels: (1) to transmit all messages to the NPU, (2) to transmit all but messages for batch-type devices, (3) to transmit only service messages, and (4) to transmit no messages. Regulation is a function of the availability of NPU buffers to receive input messages.

## DATA TRANSFERS

For downline transfers, the NPU assigns the next data buffer, sets up buffer chaining, if necessary, and switches the block to the proper internal handling or terminal/line/TIP.

For upline transfers, when the full message is ready, the NPU makes the address of the first buffer in the chain available. When one buffer is transferred, the starting address of the next chained buffer is provided by the coupler hardware. This continues until the full message is transmitted.

Since the DMA/PPU buffer channel is half-duplex (data can be sent in only one direction at a time), contention for channel use is normally resolved in favor of outputting blocks from the PPU. However, following this transfer, the protocol provides a short period during which the NPU can request channel use without the PPU contending for channel use.

No attempt is made to retransmit data in anything less than a full block. When a bad block is rejected, the entire message is rejected and must be retransmitted in its entirety.

### Link Interface Package

Since the link interface package (LIP) handles transmission and reception on both ends of a trunk, a copy of the LIP is required in both the local and the remote NPU.

Two major types of operations are handled by the LIP: loading/dumping the remote NPU, and processing data transmissions over the trunk. Data message transmissions across the trunk use a unit called a trunk transmission frame (TTF or frame).

There are three types of frames:

- unnumbered frames which establish the basic transmission states between the two nodes (such as initialization, disconnect, command rejected)
- supervisory frames that establish whether transmission/reception is currently possible (ready for data/not ready for data/rejected last data sent)

- information frames used to transmit message data; this class of frames includes frames that are carrying service messages

Both frame size and data block size are customization time selections. The information frames themselves are composed of one or more subblocks. Each subblock is a buffer of information related to a single message so that the frame may be considered as a packet of information subblocks containing one or more message parts for one or more terminals.

Either end of the link may initiate data transmission when conditions warrant. Once the interfacing LIPs have established the normal mode, data transmission can begin.

A remote NPU has no coupler to the host, and therefore no HIP. Terminal data passes through the multiplex subsystem of the remote NPU twice: once as it passes between the terminal and the NPU, and once as it passes between local and remote NPUs. Upline data in the remote NPU is demultiplexed and passed to the appropriate TIP for conversion. Completed, converted messages are passed to the LIP for framing and then passed through the multiplex subsystem, over the trunk to the local NPU. Trunk transmission rate is up to 19.2 Kbps.

In the local NPU, upline data from the trunk is received by the LIP and reconstructed into a message in data buffers. Then it is passed to the HIP for transmission to the host. Downline data is taken from a message data buffer, assembled into frame format by the LIP, and sent to the remote NPU. Once it is demultiplexed by the LIP/multiplex subsystem, it is ready to be passed to the appropriate TIP for conversion to terminal format.

### LOADING/DUMPING OF REMOTE NPU

The local NPU processes the load/dump operation in its overlay area. The program information is transmitted to/from the local NPU overlay area in block form. The local LIP passes the programs (downline) and receives the dumped main memory contents (upline) in frame format. The remote NPU LIP is responsible for stripping the frame information from the downline subblocks and loading these subblocks (parts of programs) at the location indicated by the host. For dumping, the LIP is responsible for placing the main memory contents (starting at the address indicated by the host) into frames and sending the frames to the local NPU.

Configuring the remote NPU is handled by service messages, as in the case of configuring a local NPU. The service messages are transmitted across the trunk in the same manner as any other message data.

### TRUNK TRANSMISSION PRIORITIES AND REGULATION

A high or a low priority is assigned to each subblock. High priority is associated with interactive terminals and low priority is associated with batch terminals. Each time a new frame can be transmitted the LIP scans the high and low priority queues. If high priority data is waiting, it is always transmitted ahead of low priority data.

On input (in either the local or the remote NPU), data can be rejected if the number of available buffers has dropped to the threshold level. First low-priority traffic is rejected, then high-priority traffic. Supervisory frames are not included in this priority scheme. These frames contain some command/status information, but do not include most service message instructions which are treated as high

priority. Thus, during regulation, some command/status information can be rejected while other command/status information passes over the trunk.

## TRANSMISSION ASSURANCE

The CDCCP protocol requires that each frame be acknowledged. Since several frames may have been transmitted before a negative acknowledgment for a given frame is generated, all frames up to and including the last properly acknowledged frame are retransmitted. No frame is released from the sending NPU until it is properly acknowledged. Frame checking is provided by a cyclic redundancy checksum (CRC) which is generated by the sending CLA and included at the end of each frame.

## Terminal Interface Packages

A terminal interface package (TIP) interfaces the terminal data (messages) to the network. The terminal interface is processed through the multiplex subsystem; the system interface is processed through the line control blocks (LCBs) and terminal control blocks (TCBs). Five standard TIPs can be included in a system:

- An async (asynchronous) TIP either in normal or extended format. This handles only interactive data.
- A binary synchronous communication (BSC) TIP that handles both batch and interactive data.
- A synchronous TIP for HASP workstations that handles both batch and interactive data.
- A Mode 4 (synchronous) TIP which processes data from both batch and interactive devices.
- An X.25 (synchronous) TIP with a packet handling (PAD) subTIP. This handles only interactive data that arrives through a public data network.

Each TIP handles the protocol level for its terminal type. Specialized additional information for the connection is contained in the LCB, the logical channel control block (LCCB), and the TCB. The software portion of a TIP is written on several levels:

- One or more OPS-levels control message transfer, including major error (transmission failures) processing, transfer setup, and transfer completion. Code and format translation are controlled by an OPS-level.
- A mux-2 level is occasionally used for error processing.
- One or more microprocessing (firmware) levels perform upline/downline text processing and demultiplex upline messages.

A number of OPS-levels exist; standard TIPs are written on:

- A single OPS-level: The async TIP uses one OPS-level to control message flow, error checking, and code/format translation.
- Two OPS-levels: The Mode 4, HASP, and BSC TIPs use one OPS level to control code/format conversion of blocks. Another OPS-level controls message flow.

- Several OPS-levels: The X.25 TIP uses one OPS-level to supervise protocol/terminals, another to control packet flow (related to connections between host applications and terminals), a third to control frame flow (related to the connection between the CDC network or the X.25 public data network), and a fourth (called a sub-TIP) to handle the format conversions.

## ASYNCHRONOUS TIP

The asynchronous TIP supports dedicated and dial-up asynchronous lines. The TIP provides software support for most teletypewriter-like terminals. The interface format between the host and the TIP is handled by the interactive virtual terminal and user interface.

The asynchronous TIP supports a terminal-to-virtual transform for eight types of terminals. To expand the usefulness of this TIP, a method is provided for the user at a terminal or a connected application to vary parameters and operating modes for any of the eight terminal types. This provides service for terminals which may differ from the eight terminal types.

Line types supported are:

- dedicated or dial-up
- two or four-wire
- full-duplex

The TIP is prepared to receive input at all times and attempts to deliver output whenever available, unless input is currently active. When input is detected during output, the TIP suspends output. This output is sent later. All input and output is converted between the terminal and virtual terminal characteristics.

The TIP provides an auto-recognition feature for each line. The result of this feature is a service message from the TIP informing the host of the line speed. For the 2741 terminal, the TIP provides code recognition. Several parity options are provided, and paper tape input/output is supported.

## MODE 4 TIP

The Mode 4 TIP interfaces with devices using Mode 4A or 4C protocols. A typical Mode 4 device would be the card reader, printer, keyboard, and CRT of a CDC 200 user terminal (UT).

Interactive data is exchanged with a host application in IVT format; batch data is exchanged in PRU block (PRUB) format.

The TIP is insensitive to line speeds; it supports synchronous lines operating at rates up to 9600 baud. Lines may be dedicated (with or without a transeiver) or switched (dial-up) with a modem. All lines are considered to be half-duplex.

Each line may have more than one cluster of equipment and each equipment cluster may have more than one terminal. Lines with multiple clusters must be dedicated.

The TIP performs auto-recognition when requested by the host. Auto-recognition causes the TIP to return a service message to the host which contains information on terminal type, cluster address, terminal address, and device type. Multi-cluster auto-recognition is not supported.

The Mode 4 TIP supports remote batch terminals as separate but dependent devices.

The TIP polls the terminal to determine when data should be sent.

The TIP performs recovery for line or terminal errors. Any error from which an immediate recovery is not possible is reported to the host.

The Mode 4 TIP counts all lines of batch output data sent to a terminal and all card images of batch data sent to the host. When a batch file or device connection is terminated, this data (called accounting data) is forwarded to the host to be merged with host usage accounting data.

## BINARY SYNCHRONOUS COMMUNICATIONS (BSC) TIP

The BSC TIP provides data interchange between a host application program and a remote IBM 2780, 3780 or compatible batch terminal. The TIP provides batch and interactive capabilities. The interactive console is simulated by accepting input from the card reader and sending output to the line printer.

Exchange of information between the NPU and a terminal uses the point-to-point binary synchronous communications protocol with contention resolution. Batch devices communicate with host applications using PRUB format; interactive data uses IVT blocks. The normal code of a 2780/3780 is EBCDIC; transparent mode is permitted.

BSC terminals can be attached to an NPU through dedicated or dial-in synchronous lines operating at speeds up to 19200 bps. A terminal consists of a required card reader, a required line printer, and an optional card punch.

BSC input devices have precedence over output devices and interactive devices have precedence over batch devices.

For non-transparent line printer output, the TIP supplies appropriate carriage control transformations (format effector processing). The host can supply preprint or postprint format effectors; BSC terminals support only postprint carriage controls.

A print message (PM) in the output stream to a printer stops the batch output and allows the host to send an interactive output message to the printer.

Autorecognition allows the terminal to report its own type, cluster address, and terminal address. The terminal address is used for the optional card punch.

## HASP MULTILEAVING TIP

The TIP provides network interfacing to a HASP multi-leaving-type of terminal which may contain both interactive and batch devices. These terminals have computer-like functions.

The term multileaving describes the computer-to-computer communications technique used by a HASP terminal. The system uses fully-synchronized, pseudo-simultaneous, bidirectional transmission of a variable number of data streams between two computers and requires binary synchronous communications facilities. In this configuration, the multileaving capability is used only in the upline direction.

The basic element of multileaving transmission is a character string which is embedded in a data (message) block. One or more character strings are formed from the smallest external element of transmission—the physical record.

The transmitting program segments the data to be transmitted into an optimum number of character strings. The receiving program reconstructs the original record for processing. Multiple physical records of various types can be grouped together in a single transmission block. Multileaving allows for two computers to exchange transmission blocks containing multiple data streams in an interleaved fashion. For optimum use of this capability, the system controls the flow of one data stream while continuing normal transmission of others. To meter the flow of individual data streams, a function control sequence (FCS) is added to each block.

Error detection and correction information are also provided.

Protocol Operation - After the communications line is initialized and the terminal is signed on, the NPU and the terminal transmit idle blocks until a function is desired. The process initiating the function transmits a request to initiate; the receiving process transmits permission to initiate. The requesting process then transmits data until an EOF is encountered. To transmit more data, the request to initiate must be repeated.

Data blocks are transmitted one block at a time. Before another block can be transmitted, the receiving process must transmit a positive response.

Console functions (operator messages/commands) do not follow the request-to-initiate/permission-to-initiate sequence. A console function may be initiated at almost any time.

The following errors are recognized: cyclic redundancy check (CRC) errors, illegal block format, unknown responses, timeouts over the line, and a break in the sequence of transmitted blocks.

For bad downline data, the TIP attempts to retransmit the block three times. On the fourth failure, the TIP forces a line inoperative status on the terminal.

For upline data, the NPU attempts to receive a bad block four times. On the fourth failure, the TIP forces a line inoperative status on the terminal.

Data Conversion and Compression - HASP terminals normally use EBCDIC code. Interactive data is exchanged with application programs in the host which use ASCII code in IVT format. Batch data is exchanged with applications programs which use display code in PRU format. In either case, the TIP makes the required format and code conversions. Transparent data is allowed in batch mode. Data compression is allowed in both transparent and non-transparent modes.

HASP Console - The HASP console data is handled by the IVT. Auto-input is permitted.

The HASP TIP accounts for all batch data exchanged with a terminal, including data sent in transparent mode to the plotters. When a batch file or device connection is terminated, this accounting data is forwarded to the host to be merged with other host usage accounting data.

## X.25 TIP WITH PAD SUBTIP

The X.25 TIP with the packet assembly/disassembly (PAD) subTIP interfaces a NOS network to selected TTY-type terminals which are attached to an X.25 network. The connection between the X.25 network and the NOS network is handled using a data movement protocol similar to that used by the LIP to connect local and remote NPUs.

The terminals must use ASCII code, but can be attached to dial-up or dedicated lines. The interface format between the host and the subTIP is handled by the interactive virtual terminal. Terminals are also supported in transparent mode.

This TIP operates on several levels:

- A subTIP level that interfaces the IVT format required by the host to the ASCII packet format required by the PAD subTIP. Packet characteristics are governed by the PAD access portion of the X.25 network.
- A packet handling level that interfaces to the packet transmission and reception requirements of the X.25 network's PAD access.
- A frame handling level that interfaces the X.25 network's high-speed data transmission and reception requirements.

## CHANGES REQUIRED TO WRITE A NON-STANDARD TIP

Any programmer desiring to write his own TIP should use the CCP System Programmer's Reference Manual so that he may understand, in detail, the functions CCP must provide to interface a terminal to a host applications program.

The State Programming Reference Manual provides a description of the microcode necessary to write the microcode portion of the TIP.

## CCP Software Languages

CCP programs and routines are written in one of three types of source code:

- PASCAL language: This type of source code is used to write the bulk of CCP programs.
- Macro assembler code: A few frequently used routines and subroutines are coded in this assembly language. All of these routines are base systems or network communications modules. TIPs do not use this source code.
- State programming language: A group of macroassembler macro commands has been defined as the state programming language. This communications-oriented language is used by TIPs to convert message code/format on the microprocessing level. Each TIP provides a set of upline programs (input state programs and in some cases upline text processing programs) to demultiplex incoming data and to convert terminal code/format to IVT or PRU format. Each TIP also provides a set of programs (called downline text processing programs) to convert downline data from PRU or IVT code/format to terminal code/format.

## PASCAL LANGUAGE/CCP SUPPORT SOFTWARE

The support software for CCP is called the CYBER Cross System. It consists of the following programs:

- PASCAL Compiler
- Macro Assembler
- Micro Assembler
- Load-File Build Utilities

Additionally, one more program is provided for CCP support:

- UPDATE: a program for maintaining source decks in a conveniently compressed format

The support software operates on a host computer, and the principal output is the CCP load file which resides on host mass storage, and which is available to load and initialize the NPU in the network.

The source language, PASCAL, was chosen to simplify coding for the NPU microprocessor, which would otherwise use the relatively low level 1700 source language.

**PASCAL Compiler** - The PASCAL language is defined in detail in the CYBER CROSS System PASCAL Reference Manual. Important aspects of the language are summarized here.

PASCAL is a high-level programming language patterned after ALGOL 60. The PASCAL user defines the task in statements that are processed by the compiler to yield a variable number of actual program instructions.

The PASCAL source language consists of two essential parts:

- description of actions to be performed
- description of data on which actions are performed

**Macro Assembler (CLASS)** - The CLASS macro assembler is described in detail in the CYBER Cross System Macro Assembler Reference Manual. Here, the macro assembler functions are discussed in terms of the source program and the output. A few base system and network communications modules have been written in this language to speed processing. It is assumed that these programs are invariant.

The macro assembler language allows definition of macros. A set of these macros has been predefined for CCP to form the state programming language. All modules written in macro assembler language can be found in an assembly listing.

**CLASS Source** - A source program consists of one or more subprograms. Each subprogram is a set of source statements preceded by a NAM card and followed by an END card. Each subprogram may be assembled independently, or several may be assembled as a group. The main subprogram of a group is the one to which initial control is given; it need not be the first subprogram in the group.

Communication between subprograms is accomplished by subprogram linkage pseudo-instructions and by the use of common and data storage.

A source statement consists of location, instruction, address, comment, and sequence fields, respectively.

Pseudo instructions control the assembler, provide subprogram linkage, control output listing, reserve storage, and convert data. They may be placed anywhere in a source language subprogram, but NAM must be the first statement of a subprogram and MON or END must be the last statement.

A frequently used set of instructions may be grouped together to form a macro. Once a macro is defined, it may be used as a pseudo instruction. The CLASS assembler includes two types of macros:

- **Programmer-defined:** macros declared and defined by MAC pseudo instructions; each macro may be defined anywhere in the program prior to the first reference to it; comment cards may be placed anywhere in the macro definition
- **Library:** definitions contained on the system library that may be called from any subprogram

CLASS Output - There are two principal CLASS outputs:

- **A relocatable binary output:** The assembler outputs relocatable binary format records of variable length with a maximum of 120 characters from any peripheral device in the system. The driver for the input device verifies that the block is read correctly.
- **Listed output:** A number of listed output options are available, including mapping options. The assembly list output by CLASS consists of descriptive information related to the source statement, followed by a listing of the source statement.

Three types of Cross reference maps can be obtained:

- a complete Cross reference map
- a short Cross reference map
- a macro Cross reference map

Micro Assembler - The micro assembler is described in detail in the CYBER Cross Micro Assembler Reference Manual.

The assembler for the microprogrammable processors provides the mnemonic language necessary for the programmer to write a microprogram. The assembler translates symbolic source program instructions into object machine instructions and provides a listing of assembly results. Here, the micro assembler is discussed in terms of input and output.

- **Input:** A source input statement to the micro assembler consists of 11 fields. Of these fields, the location and comment fields are used to improve the documentation of the assembled microinstructions, while the eight remaining fields correspond to the eight fields of the microinstruction. Mnemonic instructions allow the programmer to use convenient names to specify the binary information to be inserted in each field of a macroinstruction. Pseudo instructions fall into five classes: assembler control, listing control, memory management, data definition, and object code output pseudo instructions.
- **Output:** The output consists of an assembly listing including diagnostics if errors occur, a zero location map, an origin location map, and a relocatable object image.

CYBER Cross Build Utilities - Four build utilities are used to generate a load module for an NPU. This load module is processed by the NOS installation utilities into a load file that is downline-loaded into an NPU to provide its on-line system. The utilities are:

- An Expand utility defines the characteristics of the variant that is to be used in a given NPU; that is, it defines the memory size of the NPU, the TIPs to be used, the NPU's identifier to the network, whether it is a local or remote NPU, the maximum number of lines that the NPU supports, and identifiers for any trunks that are used.

A second portion of the Expand utility defines the variant for the NOS load file generator.

- An Autolink utility generates the directives that are used by the Link utility. One of the inputs to this utility is a file containing the object code for CCP programs. This is the code that was produced by the macroassembler or by the PASCAL compiler. These object code modules can be retrieved from a library. During its processing, the Autolink utility locates CCP programs so that a maximum amount of memory space is available for message handling in the on-line system.
- A Link utility generates two files: a memory image load module file and a symbol table file. Programs in the memory image load module are placed at the absolute locations where they will execute. The symbol table provides addresses of all entry points to these programs. These two files are used by the Edit utility.
- An Edit utility allows the user to initialize values in selected variables and fields. The output of the Edit utility is an initialized memory image load module. This module is presented to the NOS load file generator, along with variant information from the Expand utility. The load file generator produces the NPU load file.

All of these utilities are used in the CCP installation procedures. See the CYBER Cross Build Utilities Reference Manual for details of these utilities. The build procedures themselves are described in the NOS Installation Handbook.

#### UPDATE

UPDATE provides a means of maintaining source decks in conveniently updatable compressed format. The program is described in the UPDATE Reference Manual.

By using UPDATE, a user initially transfers a collection of source decks to a file known as a program library. Each card of each deck is assigned a unique identifier when it is placed on the library. This allows each card to be directly referenced during an UPDATE correction run. During correction runs, cards are inserted into or deleted from the program library according to sequence identification. However, the image of a card, even though deleted, is maintained permanently on the program library with its current status (active or inactive) and a chronological history of modifications to the status. If the history lists the card as being currently inactive, the card has been deleted and is, in effect, removed from the deck. If the status of the card is active, the card is in the deck; either it has never been deleted or has been deleted and restored. During a single UPDATE correction run, a card may undergo one or more modifications or no modifications.



The UPDATE purge feature can be used to permanently and irrevocably remove cards from the program library. Once a purge has been performed on a program library, it cannot be restored to an earlier level. A set of corrections also has an identifier associated with it. Any cards affected by the correction set can be referenced, relative to the correction set. In later correction runs, all or part of a correction set can be removed (yanked). Yanking differs from purging in that it is a logical operation. The effects of a yank can be reversed.

With UPDATE directives and control card options, the user directs the process of creating a program library, correcting it, and copying the updated programs to a compile file for subsequent use by assemblers and compilers.

The compile file is a primary output of an UPDATE run. This output contains only the active cards of non-common decks requested by the user.

A second type of output is a new program library. This contains updated decks requested by the user in program library format for use as an old program library in subsequent UPDATE runs. This is a required form of output during an UPDATE creation run. It may become an old program library on subsequent correction runs.

A third type of UPDATE output is in the form of an UPDATE source file. This file resembles the decks originally used to create the program library. It contains active source cards of the decks and common decks taken from the updated program library. The source file provides a means of obtaining a back-up copy of the library, of purging all inactive cards, and of resequencing the library.

A source deck can be assigned common status at the time it is first incorporated into a program library file. Common decks can be called from within other decks as they are being written on the compile file. On the compile file, UPDATE replaces the card calling a common deck with a copy of the deck, provided that the call occurs within a deck or within a common deck called within a deck.

Source decks can be added to a program library during a creation UPDATE run or during a correction run provided that all common source decks precede any source decks in which they are called.

UPDATE permits two program libraries to be merged. In this mode, UPDATE alters any deck on the merge file having a name that duplicates a name already on the primary program library by assigning it a deck name that is unique.

## STATE PROGRAMMING LANGUAGE

The set of macro assembler macrocommands making up this language comprises the entire language. No other macro assembler code is included in state programs.

The language is used for speeding code/format conversion of data. Standard interface routines between PASCAL-coded (OPS-level) programs and the state programs are provided. The state program source code can be found in an assembly listing for the appropriate TIP. The language and its use are described in the State Programming Language Reference Manual.

## 255x HARDWARE

The basic product group for the NPU and associated hardware is:

- **2551 Network Processing Unit.** This consists of a communications processor with a recommended minimum of 96K words of main memory, 2K words of micromemory, a maintenance panel, a cyclic encoder, a multiplex loop interface adapter (MLIA), and a loop multiplexer (LM).
- Optional main memory expansion units (2554-16 for 16K words of added memory or 2554-32 for 32K words of added memory) are available. Maximum main memory size is 128K words.
- 2580-4 Autostart System Module is required if the NPU is used as a remote unit. This uses a tape cassette.
- At the terminal interface, one or more communications line adapters (256x) are required.

## Communications Processor

The communications processor is a microprogrammed 16-bit processor. Its program instructions are stored in main memory while the microcode, which dictates how they are to be executed, is stored in micromemory. This microcode provides additional power for character and field manipulation, indexing and other communications-oriented processes.

## MAJOR FEATURES

- Microprogrammed and macroprogrammed
- 96K to 128K words of 16-bit (plus parity and protect) MOS main memory
- Eight memory-addressing modes
- Memory word and region protection
- Main memory parity detection
- High-speed I/O data transfer
- Programmable cyclic encoder

## MACROINSTRUCTION REPERTOIRE

The communications processor incorporates the CDC CYBER 18 Series instruction set plus extensions. Some instructions are immediate (literal), resulting in a saving of operand storage space and execution time. Multiword instructions, like indirect addressing, are a means of addressing locations which cannot be accessed directly.

To aid in programming, most CCP programs are written using PASCAL language rather than macro assembler language.

## REGISTERS

The communications processor emulates a total of 12 registers. Eight registers are used in the execution of the CYBER 18 instruction set while four general-purpose registers have been added to support the extended instruction set. There are also three special-purpose registers used exclusively for machine control.

## INPUT/OUTPUT

The communications processor features both a direct memory access (DMA) interface and an internal data channel (IDC) interface to peripherals. Using the IDC interface, the program controls the data transfer, employing the Q register to address the desired peripheral and the A register to transfer data, commands, or status between CPU and peripheral. The IDC transfer rate is  $1.6 \times 10^7$  bytes per second. The DMA interface permits direct transfer of data between the peripherals and main memory, bypassing the communications processor main registers. The DMA transfer rate is  $2.8 \times 10^6$  bytes per second. Coupler transfers to the host use the DMA channel.

## PROGRAM PROTECTION

The communications processor offers two modes of protection from the damage which may be done by programs accessing memory outside of their own region:

- Individual words are declared protected by setting a bit in memory associated with that word.
- Upper and lower bounds to define an unprotected region. This has the same effect as word protection, except that a large unprotected area can be defined more quickly. This method is provided by the 255x software.

## INTERRUPT SYSTEM

The interrupt system is implemented through microprogram and consists of 16 levels of external macrointerrupt, and 16 levels of internal microinterrupt. Macrointerrupts are the traditional CYBER 18-style interrupts; microinterrupts are primarily used internally to control the execution of micromemory instructions associated with the real-time processing of input/output data.

## BREAKPOINT

The breakpoint facility insures the termination of a program at a predetermined location in memory. Breakpoint is useful in program debugging. This feature is activated through the NPU maintenance panel and can be used at either the macro or microcode level.

## AUTOLOAD

The loading of programs is provided by this feature. The operator can downline-load the NPU from an associated host computer.

## TAPE CASSETTE

A tape cassette is provided as part of the remote NPU configurations. The tape cassette is used as a load device for auto-start purposes.

## NPU MAIN MEMORY

The NPU uses high-speed MOS memory. All memory configurations feature the use of 18-bit storage words comprised of:

- 16 data bits
- 1 parity bit
- 1 program protect bit

Communications processor microcode allows full, direct access to 65K words of memory. Use of larger memory (over 65K) is restricted to applications modules, i.e., TIPS, on-line diagnostics, etc. Features of this large memory use are:

- virtual memory space of 65K at any instant in time
- 32-page registers to allow mapping of each 2K page in virtual memory space to any 2K physical page
- 2 sets of page registers to allow for rapid switching

## Multiplex Subsystem

This system utilizes demand-driven multiplexing. Processor intervention is required only when incoming data characters are received or when output data blocks require servicing. The multiplex subsystem components include:

- multiplex loop interface adapter (MLIA)
- loop multiplexer (LM)
- communications line adapters (CLAs)

The first two are an integral part of the 255x although the communications processor treats them as peripheral devices. The CLAs are peripheral devices attached to the input/output multiplex loops.

## MULTIPLEX LOOP INTERFACE ADAPTER

The multiplex loop interface adapter (MLIA) connects the communications processor to the loop multiplexers via the multiplex loop. It initiates and terminates the input and output multiplex loop requests. It also provides basic timing and control. The MLIA provides serial-to-parallel and parallel-to-serial data conversions, loop control and error monitoring.

## LOOP MULTIPLEXER

The loop multiplexer (LM) provides the electrical and mechanical interface between the multiplex loop and communications line adapters (CLA) which reside within the loop multiplexer. Additional loop multiplexers are available as 2556-11 Loop Multiplexer Line Expansion Modules. A total of eight loop multiplexers will connect up to 254 communications lines.

## Communications Console

Two standard types of console may be used for offline operations (consoles are not used online):

- 713-10 CRT, variable speeds up to 30 characters per second
- 752-10 Display Terminal, variable speeds up to 9600 bits per second

Other compatible terminals (such as teletypewriter devices with similar line speed and I/O characteristics) can be used.

## 2558-3 Channel Coupler

The channel coupler provides a direct link between a host computer and the communications processor. The primary function of the coupler is to pass 8-bit data characters directly between the computer memories with minimum software supervision. There are four additional control bits associated with each character. The coupler provides the means for transfers between a CYBER peripheral processing unit (PPU) and an NPU at CYBER-channel transfer rates. Supervision is provided by both PPU and NPU software commands and by control words in the NPU buffer. Buffer chaining in NPU memory is provided.

All coupler operations are initiated by PPU function commands and/or NPU I/O commands. The transfer of data between computers requires additional PPU I/O instructions and control words in NPU memory.

## Communications Line Adapters

The 256x series of communications line adapters (CLAs) are used to interface the NPU to various types of terminals or communications facilities. The CLA provides the electrical interface, isolation, control, and interim character buffering.

There are three classes of 256x CLAs:

- 2560 Series Synchronous Communications Line Adapters
- 2561 Series Asynchronous Communications Line Adapters
- 2563 Series CDCCP Communications Line Adapters (used with remote NPUs)

### 2560 Series Synchronous Communications Line Adapter

The 2560 series CLA provides for the connection of two synchronous communications lines.

A 2560 series CLA provides for the connection via modems (data sets) of lines conforming to the EIA RS-232-C or CCITT V.24 interface standard. The CLA is compatible with AT&T 201/208 data sets and provides for the termination of two communications lines.

The 2561 CLA provides for the connection of two asynchronous communications lines at all standard speeds up to 9600 bits per second. There is one model: the 2561-1.

The 2561-1 provides for the termination of two lines conforming to EIA RS-232-C or CCITT V.24 standards. It is compatible with AT&T 103/113/212 data sets or their equivalent. Local connection without a modem is available.

A 2563 series CLA is required for the communications line connecting local and remote NPUs. This line (trunk) uses the Control Data Communications Control Procedure (CDCCP) at speeds up to 20000 bits per second. The line is connected via modems (data sets) conforming to the EIA RS-232-C or CCITT V.24 interface standards.

## Sample Configurations

Figure 1-8 shows a typical configuration for a local 2551-1.

The 2551-1 is intended as a local NPU or a remote NPU. In the remote format the coupler is absent and a trunk-connection links the local and remote NPUs. The unit is limited to a maximum of 32 input lines.

The 2551-2 is intended as a local NPU or a remote NPU. In the remote format, the coupler is absent and a trunk connection links the local and remote NPUs. This unit can connect up to 254 communications lines.

## Terminals Supported

The NPU/terminal interface is supported by one of several standard terminal interface programs: the asynchronous TIP, the Mode 4 (synchronous) TIP, the BSC TIP, the HASP (synchronous) TIP, and the X.25 TIP. The classes of terminals typically supported by each of these types are as follows:

	Terminal Class
• Mode 4 TIP	
CDC 200 User Terminal	10
Card readers	10
Line printers	10
Tektronix Synchronous 4014	10
CDC 714-30 User Terminal	11
711	12
714	13
CDC 734 Terminal	15

Terminal code may be ASCII, EBCDIC, external BCD, or correspondence code. Terminals may use Mode 4A or 4C protocol.

	Terminal Class
• X.25 and Asynchronous TIP	
TTY M33, 35, 37, 38	1
CDC 713	2
IBM 2741 (asynchronous only)	4
TTY M40	5
Hazeltine 2000	6
CDC 751	7
Tektronix Asynchronous 4014	8

All X.25 terminals use ASCII code only.

● HASP TIP	Terminal Class	● BSC TIP	Terminal Class
Data 100	9/14	IBM 2780	16
Harris COPE 1200	9/14	IBM 3780	17
Harris 1620	9/14		

Terminal class 9 consists of HASP postprint devices; terminal class 14 consists of HASP preprint devices.

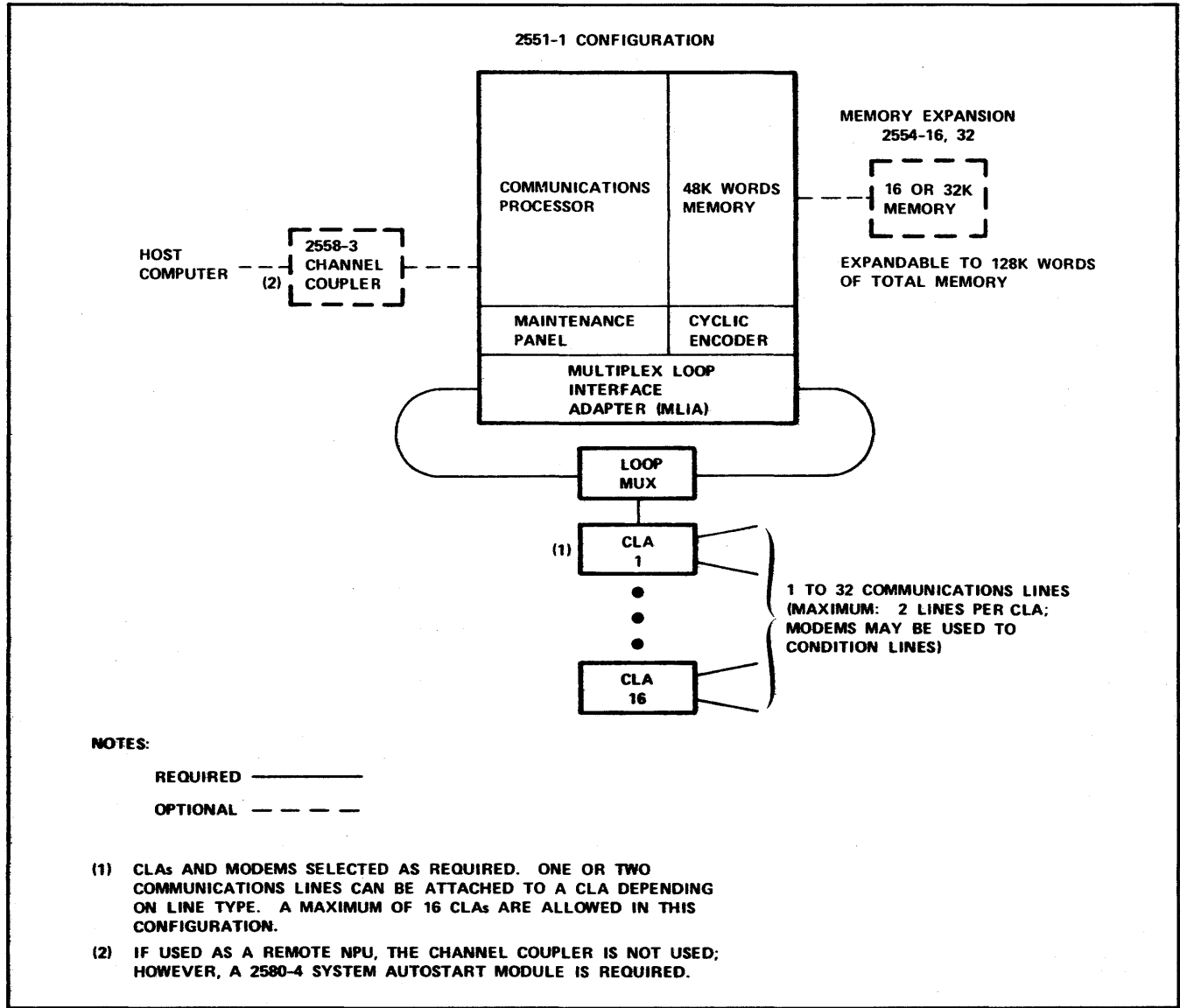

Figure 1-8. Sample NPU/Peripheral Hardware Configurations

The NPU, operating under control of CCP, provides multiplexing of terminal data for the host. The necessity for multiplexing has been explained in section 1, under the heading of multiplexing operation.

**MULTIPLEXING, SWITCHING, AND DATA CONVERSION**

On input (upline) transfers, the data from the various terminals (or remote NPUs) is multiplexed, placed into PRU format or interactive virtual terminal (IVT) format, demultiplexed and gathered into message-sized buffers, and passed to the host. On output (downline) transfer, the messages from the host are translated into real terminal format, if necessary, and are then multiplexed to the terminals, one character at a time.

There are some exceptions to this scheme. If a remote NPU is in the system, the conversion from terminal to PRU or IVT format occurs in the remote NPU. Data is passed between the remote and local NPUs in frame format. It is then reconstituted in the receiving NPU where processing continues as if the data had just come from the host (downline), or from the TIP (upline).

The two major interfaces are buffered. On the host side, upline, full messages are placed in one or more (chained) buffers, the host is alerted that the message is ready, and the transfer takes place over the direct memory access (DMA) channel connecting the peripheral processing unit (PPU) of the host to the NPU. There is, of course, some communication between the host and the NPU to ready the transfer. The PPU receives the message in buffers. Message includes data messages, certain types of blocks that are used to transmit control information, and service

messages that carry control and status information. When the message is reconstituted in the host, and confirmed as being good data, the PPU passes the buffered data to the applications program (see figure 2-1).

The downline transfer at the host interface is the converse of the operation described above. When the PPU has the complete message in a buffer, it notifies the NPU. If the NPU has sufficient buffers to start another message, it assigns a data buffer and accepts a block or blocks of information, assigning successive chained buffers as needed until the entire message is reconstituted in NPU main memory. If the data is confirmed as being good, the message is passed to the next stage of processing, which is transformation to terminal format. This is accomplished by a combination of TIP and BIP conversion processes.

Buffering also occurs at the terminal interface. All terminals are connected to the input and output multiplex loops via CLAs and communications lines. For an upline message, the tagged data characters are picked from the input multiplex loop, and passed to a circular input buffer along with tagged data from all other active terminals. It is then demultiplexed into one or more data buffers. When the message is completely assembled, the TIP and the BIP transform the data as necessary. In many cases, this is a one-pass process. However, the HASP TIP requires two stages of demultiplexing. The end product is a buffered message ready to be passed through the host interface to the applications program in the host.

NOTE

In this highly generalized discussion, it is assumed that all messages are being passed through the NPU from host to terminal or conversely. However, many control messages originate or terminate in the NPU itself.

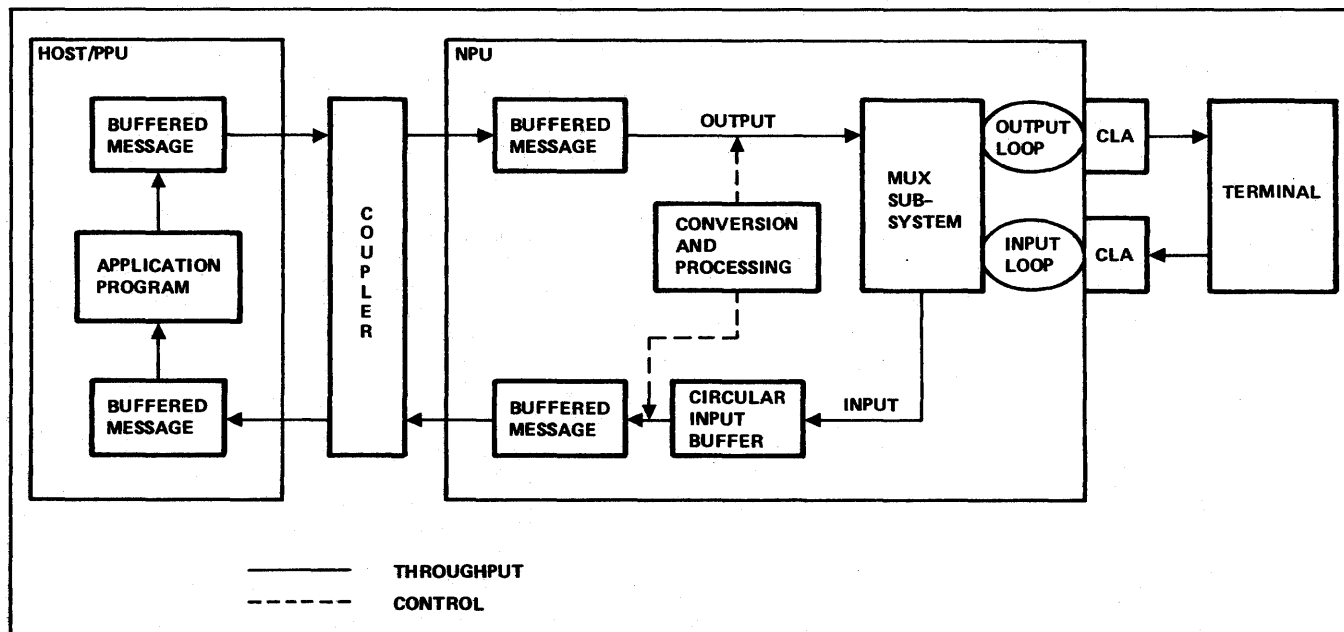

Figure 2-1. Simplified NPU Buffered Transfers

Any buffering at the terminal is invisible to the NPU. The NPU need only assume that the line to the terminal can input or output data at the minimum rate for that line. If this does not occur, the line is noted to be bad and the associated terminal is marked down. The entire message associated with the line failure is rejected.

Downline transfers at the terminal interface are handled differently for batch and interactive devices.

In the case of ASYNC IVT blocks, the BIP passes data to the TIP which converts the data, queues it, and passes it to the multiplex subsystem.

In the case of PRU blocks, the BIP passes data to the TIP which converts it to one or more transmission blocks (a transmission block carries a printer line or a card image) and then passes the transmission blocks back to the BIP. The BIP then queues these blocks to the TIP unless there is some reason to interrupt the batch output process. If there is such a reason, the BIP refrains from passing the transmission blocks on to the TIP as the TIP requests them. This makes it possible to send interactive messages to the terminal. When the batch interrupt is cleared, the BIP again starts passing transmission blocks, which the TIP then passes to the multiplex subsystem.

The multiplex subsystem picks the message, one character at a time, from the transmission block, tags it, and places it on the output loop. The CLA for the line is responsible for recognizing its own tagged data, passing it to the receiving terminal, and requesting more data. This process continues until the entire transmission block is sent.

Buffer space management is an important task for the NPU. Release of buffers is handled according to the criteria shown in table 2-1.

The upline switching operation performed by the local NPU is relatively simple in this release since each local NPU is connected to only one host. For this release, the NPU acts as a message gatherer. If the host should fail, the local NPU is responsible for delivering a message to the terminal indicating that the host is unavailable. When the host is reactivated, another message is sent to the terminals notifying them that the system is again operational. For remote NPUs, although potentially usable links may exist to two local NPUs, only one link is used at a time. If that link should fail, the link to the alternate local NPU is activated. From the viewpoint of the remote NPU, all traffic is channeled to the local NPU, though the identity of that NPU may change from time to time.

For downline switching, the local NPU is responsible for checking the operational status of the terminal or remote NPU. The remote NPU is responsible for checking the status of the terminals directly attached to it. There is no option to deliver a rejected message to an alternate terminal. However, since the host applications program which originated the message is informed of the failure to communicate, it is possible for that program to route the message to an alternate terminal.

Regulation of input to an NPU may cause a unit attempting to input to the NPU to have its message rejected. That unit (host or terminal) is responsible for inputting the rejected message at a later time.

Data conversion is provided for the convenience of the host application programs. These programs expect data in one of two formats: IVT in ASCII code or PRU in display code. Transparent data is also allowed. For batch transmissions, data compression is allowed if the protocol supports it. In most protocols batch input cards have trailing blanks truncated and some zero fill following the last data character.

TABLE 2-1. BUFFER ASSIGNMENT/RELEASE IN NPU

Transfer Direction	Interface	Assign	Release
Upline	Host	Receives buffers from NPU's BIP via TIP or LIP.	When coupler acknowledges that message block was correctly received, or when error occurs.
Downline	Host	Can postpone assignment based on lack of buffers; otherwise assign and chain as data is received.	Messages: when next stage of NPU processing converts message to new format or when error occurs. Control messages or blocks: when NPU finishes action specified or when message is garbled.
Upline	Terminal <sup>†</sup>	Same as host/downline, plus buffers may not be assigned if a connection has already reached its buffer limit.	Same as host/downline.
Downline	Terminal	Same as host/upline.	When terminal acknowledges that last block was correctly received or when message cannot be transmitted after several attempts (host application program is notified in latter case).

<sup>†</sup>These are demultiplexed buffer blocks, after reconstituting data from the circular input buffer (CIB). CIB space is never released.

## INTERFACES

Two interfaces have already been discussed in this section, the host interface and the terminal interface. There is also one other interface, the local/remote NPU interface.

Each interface has its own protocol or sets of protocols. It is the NPU's task to convert data from the appropriate input protocol to the appropriate output protocol. Table 2-2 summarizes the protocols and primary packets of data used for the protocol. The data packets, blocks, frames and special types of messages, are discussed in more detail later in this section.

## TRANSMISSION MEDIA

The basic transmission medium for data within the NPU is the block. This holds true absolutely at the host interface and can be considered a constant also at the other interfaces since any amount of data, even one character, is collected into a data buffer, in block form, and held until the NPU delivers the entire message, aborts the message because the channel is inoperative, or acts on the data if the data is in fact a command or a request for information. At the terminal interfaces, however, the blocks may be reformatted into frames (trunk transfers).

In the following discussion, the handshaking operation to set up a channel or line for operation is neglected. The handshaking techniques are discussed in detail later in the HIP, LIP and base software sections with respect to the host, to the NPU at the other end of a local/remote NPU link, and peripheral devices, respectively.

There are 12 block types. They can be divided into three categories:

- Data transfer blocks (MSG and BLK): For interactive devices, BLK blocks convey any part of the message but the end. MSG blocks convey all the message or the end of the message. A typical large interactive message requires several chained BLK blocks with a MSG block at the end of the chain. For batch devices, a PRU block always uses a MSG block. A single batch job may require several PRU blocks. All but the last PRU block will be full. In the last or only PRU block, an end signal (end of text, end of input, or other end signal) signifies the end of the logical chain of data.
- Control blocks: BACK blocks acknowledge receipt of other blocks; BRK, STP, STRT, RST, INIT, ICMD, and ICMDR are used to break, stop, start, reset, initiate, and interrupt the flow of data blocks. CMD blocks transfer commands to configure the network and to regulate the flow of data blocks. CMD blocks are also used to transfer network status information.
- Data assurance blocks (inter-NPU only): ACTL blocks are used to set up, monitor, and maintain continuity on the trunk connecting two NPUs. ACTL blocks appear in frames as will be apparent in the frame discussion that follows

The range of commands available in a CMD block is potentially very large. However, to establish a useful protocol, a set of commands called service messages has been defined. These messages perform the same sort of function for the NPU that supervisory messages perform in the host, transmitting commands and status.

TABLE 2-2. INTERFACE/PROTOCOL RELATIONSHIPS

Interface	Protocol	Data Packet/Responsible Modules	I/O Channel	Code Set†
Host	Block	Data block made out of (chained) buffers. "Handshaking" technique at coupler to set up the transfer. HIP and BIP handle transfers.	Direct Memory Access (DMA) (high speed)	ASCII in IVT; display code or ASCII in PRU mode.
Terminal	Any Acceptable such as Mode 4, BSC, ASYNC, HASP, X.25 with PAD sub-TIP	At NPU side, blocks chained in data buffers. Wide range of transfer rates. TIP and BIP handle conversion.	Mux Interface, Input or Output Loop	Usual are ASCII and some form of BCD; may use APL variations or correspondence code.
Remote/local NPU	Form of ISO HDLC called CDCCP	Data blocks formed into frames and chained together. Transfer rate up to 19200 bps. LIP handles frame formation and breakup. LIP at either end of line; functions complementary and depending on transfer direction.	Mux Interface, Input or Output Loop	Code is transparent to the LIP.

†Some transfers can also be in transparent format.

Comparable service and supervisory messages exist; some of these are, in essence, transforms of one another. In the host, the NAM, NS, and CS modules receive, generate, and process service messages. In the NPU, most service message processing is handled by a service module (SVM).

Service messages ordinarily do not go through the NPU as such, although they may be transmitted intact over a trunk (remote NPU/host messages), or they may carry with them a character data message to be displayed at a terminal or at a console (network operator (NOP), local operator (LOP)). Service messages are summarized in the System Programmer's Reference Manual.

A typical incoming service message solicits a response and causes the NPU to generate an appropriate response service message. Examples of this would be a configuration message, answered by a response that the device specified has been configured as requested, or a status request answered by a message carrying the requested status. In some cases, the NPU generates a so-called unsolicited response message. This somewhat confusing terminology indicates that the NPU has used the normal response form of a service message to generate a warning that the system is not operating as configured. An example is the unsolicited line status request response. That is, in fact, a report that the line specified in the message has been marked down, and further attempts to output messages to the terminal using this line will be rejected. The host must therefore take action to have the line repaired or reconfigured.

Although blocks retain some of the basic transmission format when sent over trunks connecting local and remote NPUs, a new unit of transmission called a frame is also defined. As in the case of blocks, there are different categories of frames:

- Command frames: Two types are defined, S (supervisory) frames and U (unnumbered) frames monitor channel communications.
- Data frames: I (information) frames transmit data.

Data is placed in the frame in units of subblocks. A subblock may be a full block or only a portion of a block. Normal frame size for CCP (an installation-time parameter) is 259 bytes (8 bit characters).

An example may clarify this: Suppose three messages are waiting to be sent upline from a remote NPU. The lengths are 32 bytes, 256 bytes, and 32 bytes, and are queued in that order. The 256-byte message is contained in two 128-byte data buffers. The first 32-byte message and the first buffer of the 256-byte message require together:  $32 + 128 + 2$  (frame overhead) +  $2 \times 2$  (two bytes of frame overhead per subblock) = 166 bytes. The next subblock is 128 (+2) bytes.  $166 + 130 > 259$  so the frame is closed and transmitted with 166 bytes. The next frame will contain the second half of the 256-byte message and the other 32-byte message. Since no other messages are waiting to be transmitted, this frame is also closed and sent.

#### NOTE

This simplified example ignores such factors as checking frames on the receiving side, acknowledging them, and requiring retransmission of all frames since the last acknowledged good frame in the event that a frame transmission fails.

As soon as the frame is stripped off in the receiving NPU, the various messages are reassembled into data blocks and all traces of frames disappear.

## INITIALIZATION

Since the terminals connected through the NPU must be configured to match the host's image of the network configuration, and since the NPU has no mass memory, the NPU image is kept on host mass storage and the NPU is downline-loaded from the host. After the baseline system is loaded, the host directs the NPU to configure its links, lines, and terminals by means of a series of service messages. The three steps of the initialization are:

- (optional) dump the NPU so that contents can be used for later analysis to determine cause of failure
- load the NPU from the host with the bootstrap program
- configure the NPU by establishing the parameters of the logical links, lines and terminals connected to this NPU

Differences in the initialization cycle result from hardware differences. The two formats required are for:

- 2551 local NPUs
- 2551 remote NPUs

The host normally attempts to load/dump an NPU only if the NPU fails or if the network operator specifically requests a load. If the host itself fails, the NPU must also be reloaded when the host comes back on-line. In the case of an NPU failure, the host (optionally) first dumps the NPU contents. The NPU is then loaded. If the first attempt to load the NPU fails, another dump is taken. On subsequent consecutive attempts to load, dumping is inhibited. After a set number of times, the NPU is marked down. Failure of a local NPU is detected by the host PPU channel.

NPUs that are local to the host are loaded and dumped via the CYBER Coupler under the control of the PPU. The remote NPU requires an overlay process in the local NPU. When a remote NPU fails, the deadman timer is activated. A bootstrap load/dump program is read into the NPU from the system autostart module cassette, and that bootstrap program starts execution. The remote NPU then establishes contact with the local NPU. The local NPU communicates with the remote NPU using a restricted set of the communications protocol during this load/dump procedure. From this point forward, the load/dump procedure is controlled by the host, using an overlay in the local NPU.

After the NPU is loaded, the host configures the unit by establishing all logical links and logical connections for that NPU. A logical connection is the association of two elements made by the assignment of a network logical address. The network logical address is a set of three numbers: two node IDs followed by a connection number. These three numbers are used together to trace through a set of increasingly specific directories: the destination node directory, the source node directory, and the connection directory. This process ultimately points to a terminal control block (TCB). The directories also have information concerning the logical link control block (LLCB), the line control block (LCB), and the logical channel control block (LCCB). It is these three control blocks that are the subject of the NPU configuration process.



The network supervisor (NS) program and the communications supervisor (CS) program in the host are responsible for the control of logical links and connections, respectively, in the network. All logical links and connections are explicitly configured, reconfigured and deleted by NS/CS using service messages (SM). Configuration proceeds in three stages:

- establishing logical links
- configuring lines
- connecting terminal over the lines

NS establishes all logical links which the current state of the network permits. NS notifies CS of each logical link to be established and the initial regulation level for the logical link. CS configures the lines and attempts to connect each terminal on the line.

To connect the terminal, the line must be enabled. The terminal is connected by the NPU building the terminal control block (TCB) for the terminal. When the configure or reconfigure action has been performed, the block protocol is initiated and the connection is in use.

## BASE SYSTEM SOFTWARE

The base system software consists of most of those portions of the CCP that are normally associated with a comprehensive operating system together with the associated standard utilities. The base system, plus the block interface package (BIP), and the other interface packages (HIP, LIP, and all TIPs) constitute the standard CCP software. Initialization and configuration was described previously. The major features of the base system are:

- system monitor
- buffer handling
- worklist services
- queuing mechanisms
- direct program calls (switching services)
- interrupt handling
- timing services
- globals
- control block services
- directory maintenance
- standard subroutines for code translation, and special arithmetic functions
- multiplex subsystem operation

## SYSTEM MONITOR

The NPU is a multiple interrupt level processor. Interrupts are serviced in a priority scheme in which all lower priority interrupts are disabled during execution of a program operating at a higher priority level. When no interrupt is in effect, the processor runs at its lowest priority, known as

the operations monitor (OPS) level. Programs on the OPS level communicate with one another using worklists. Parameters for the requested task are stored in a worklist and the worklist is placed in a first-in/first-out queue for the program to be called. The monitor scans the list of all programs capable of having worklist queues. If the monitor scan discovers a program with one or more worklists in its queue, control is passed to the program, together with the worklist which defines the parameters for the task. It is possible to pass control to a program for execution of more than one worklist, if that program is designated as being allowed to process more than one task before releasing control. In this case, the maximum number of queued tasks (worklists) are executed by the program before the program returns control to the monitor. When the task or tasks are completed, control returns to the monitor which resumes the scan at the next program on the list.

Each time a program completes, a timer is advanced. This timer is checked by the interrupt level timer routine at specific system-defined intervals. If the timer expires, it indicates that some OPS-level program has been abnormally delayed. Monitor execution is then terminated and the NPU is stopped.

## BUFFER HANDLING

The buffer handler allocates the four types of buffers and recovers buffers for the four free buffer pools when users are finished with them. Buffers are potentially available in six sizes: 4, 8, 16, 32, 64, and 128 words. At installation time, the user chooses any four contiguous sizes; for instance, 8, 16, 32, and 64 words. The largest size is designated as the data buffer size.

Buffers are assigned one at a time; buffers can be released singly or in a chain of buffers.

In conjunction with testing buffer availability to assure a minimum threshold number, buffer maintenance periodically attempts to adjust distribution of buffer sizes by using buffer mating or buffer splitting to replenish any buffer pool that is at threshold level.

## WORKLIST SERVICES

Worklists provide a convenient method of handling communications between software modules that do not use direct calls. The list services function manipulates worklists by making worklist entries from any priority level (including OPS level).

Characteristics of the queued worklists are:

- first in, first out
- one to six-word entries, but all entries in any one list of equal length
- lists exist in dynamically assigned space
- No limit in the number of lists serviced

If there is contention between priority interrupt levels when making an entry, this conflict is resolved by use of an intermediate worklist array.

## QUEUING MECHANISMS

Several major queues are defined:

- terminal control block (TCB) queue which controls input messages from the various terminals
- TCB output queues which control messages to be passed downline to the terminal
- timing queue

## DIRECT PROGRAM CALLS (Switching Services)

Most OPS-level programs call other programs and subprograms directly. One subroutine is provided for these direct calls. The same program also is the final step in the worklist calling sequence. It provides switching for programs on different main memory pages, timed and periodic calls, service message switching, and overlay execution, as well as actual passing of control for programs called by the monitor.

## INTERRUPT HANDLING

The NPU can recognize 16 different macrointerrupts. Each has its own address to which control is transferred when the interrupt is acknowledged. When the computer is processing a particular interrupt, it is defined as being in the interrupt state (state 00 through 15). However, before the computer can recognize an interrupt, the corresponding mask bit in the interrupt mask register must be set and the interrupt system must be activated.

Upon recognizing an interrupt, the hardware stores the appropriate program return address to ensure that the software can return to the interrupted program after interrupt processing.

The interrupt handler that is activated also saves selected NPU registers for the interrupted program. The interrupt mask is then loaded with a mask to be used while in this interrupt state. The program then saves the current software priority level, sets the new software level, activates the interrupt system, and processes the interrupt.

During interrupt processing, an interrupt request with a higher priority may interrupt this program. Such higher level interrupts also store return address links and registers to permit sequential interrupt processing according to priority level with eventual return to the main-stream computer program.

The computer exits from an interrupt state when processing is completed. The handler inhibits interrupts, restores the registers, and retrieves the return address of the interrupted program. Control is transferred to the return address and the interrupt system is again activated.

Three microinterrupts are also serviced:

- The output data processor (ODP) services the output data demand (ODD) interrupt which each CLA generates to indicate that it is ready to output another character. The ODP (part of the multiplex subsystem) gets the next character from the appropriate line-oriented output buffer and puts the character on the output loop. The requesting CLA picks the character from the loop and transmits it.

- The input data processor (IDP) services the interrupt produced when the MLIA places a data character or CLA status into the circular input buffer. The IDP (part of the multiplex subsystem) uses the designated input state program to process the character according to the requirements of the protocol and to transfer the characters to the line-oriented input buffer.
- The timing services firmware processes the 3.3-millisecond clock interrupt which is used for the time base of all timed NPU functions.

## TIMING SERVICES

Timing services provide the means for running those programs or functions which must be executed periodically or following a specific lapse of time. These timing services are available:

- A firmware program handles the 3.3-millisecond microinterrupt to provide a 100-millisecond timing interval.
- Every 100 milliseconds, a timing routine searches a chain of time-lapse entries. If any entry's time period has elapsed, that entry is deleted from the chain and a worklist entry is sent to the program for which the delayed call was requested. Timing services also handle adding delay requests to this delay request chain.
- Every 500 milliseconds, a timing routine checks the deadman timer. The timer is reset and the monitor timeout routine is checked. If the monitor timer has expired, it indicates that the monitor has spent too long in one OPS-level program. The NPU is stopped.
- Every 100 milliseconds, a timing routine scans the list of active line control blocks (LCBs) for ASYNC TIP terminals. If a character has been received, the timeout is reset for the next character. If the character has timed out (no character received within 100 milliseconds), the LCB is removed from the active list and the ASYNC TIP is notified.
- A 500-millisecond program time has these principal functions:
  - Every second, a timing routine checks all active outputting lines to see if an output data demand (ODD) has been generated for the next character to output. If a second has expired with no new ODD interrupt, the multiplex event worklist processor is called to declare a hardware failure for the line.
  - Every 500 milliseconds, a timing routine scans all active lines for periodic requests. If the period has elapsed, the TIP is called using a worklist. Input or output can be terminated for the line if this is requested. Inactive LCBs are unchained from the set of active LCBs. Timer services also provide the means of chaining LCBs to this list of LCBs requiring periodic action.
  - A time-of-day routine is called every second. The time of day is incremented and, if necessary, recycled to start of day (00 hour, 00 minute, 00 second).

## GLOBALS

PASCAL-coded programs can use global variables, tables, and constants. PASCAL globals are defined in the CYBER Cross PASCAL Compiler Reference Manual. The principal globals used by standard CCP programs are described in the CCP System Programmer's Reference Manual.

## CONTROL BLOCK SERVICES

The line control blocks (LCBs) are a vital part of the configuration data. The blocks consist of a series of entries, one for each line. LCBs are chained together and are therefore handled as a series of active, chained blocks. Entries that are no longer active are flagged. If an entire block has no active entries, the block is unchained and released. New blocks are added as needed. The LCB space, however, is dedicated and cannot be used for other purposes.

## DIRECTORY MAINTENANCE

This set of modules sets up and maintains the directories which are used for block routing.

## STANDARD SUBROUTINES

This group of subroutines provides handling to:

- convert and handle numbers
- handle interrupt masks
- maintain paging registers
- save/restore registers
- set/clear protect bits
- code conversions
- perform miscellaneous other tasks

## MULTIPLEX SUBSYSTEM OPERATION

The multiplex subsystem has two principal tasks:

- relieve the TIPs of having to process lines according to the physical line characteristics (most line characteristics are invisible to the TIPs as a result of multiplex subsystem processing)
- multiplex the data to match the low-speed characteristics of individual terminals with the high-speed characteristics of the NPU and the host

The principal multiplex subsystem functions are:

- receives serial data from communications lines, places it in a circular input buffer, demultiplexes it and places it into line-oriented input buffers
- transmits serial data to communications lines from line-oriented output buffers
- detects and processes special characters
- translates code on input
- checks CRC
- checks and generates character parity
- detects breaks
- assembles input data into blocks

- controls modems and analyzes status
- chains data buffers as necessary to create data blocks
- processes commands issued by the communications system software
- dynamically alters the input character processing characteristics as a function of the connected terminal

Figure 2-2 shows the basic multiplex subsystem elements.

### Input Multiplexing

Each line has a communications line adapter (CLA). The CLA for each active line is sampled in sequence and if a character is ready, it is placed on the input multiplexer loop together with information identifying the source (line) and, in some cases, the nature of the character (for instance, this type may contain control information rather than a character of message data). All information on the input multiplex loop is routed to a circular input buffer (CIB) which is usually 512 words long. The demultiplexing operation picks data from this buffer and reconstitutes the messages on a line input basis.

### Output Multiplexing

When the NPU has received a message block from the host and a TIP has transformed the code/format from IVT or PRU to terminal format, the TIP notifies the multiplex subsystem that the transmission block is ready for output. The multiplex subsystem picks the characters from the line's output message buffer one at a time, whenever a new output data demand (ODD) is generated by the CLA. (The ODD indicates the terminal is ready to receive another character.) The outgoing characters are placed on the output multiplex loop, along with such control characters as are needed, and an address that will be recognized by the active line for that terminal. The CLA for the line recognizes the address, picks that data from the output loop, and marks it as being sent. When the contents of the entire output buffer for the line have been transmitted, and the message has been acknowledged as received by the terminal, the multiplex subsystem notifies the TIP. The TIP releases the message buffers and notifies the host of a successful transmission. In some cases the TIP discards the output message even if it was not successfully transmitted.

### Trunk Multiplexing

If a remote NPU is included in the network, transmissions between the local NPU (see previous subsection on 255x hardware) and the remote NPU take place over a trunk. In the local NPU, a link interface package (LIP) sets up the output buffer, and the message in that buffer remains in IVT or PRU format while being transmitted over the trunk. In the remote NPU, the downline messages are treated similarly to upline messages in a local NPU; that is, the message goes through the CIB and is then demultiplexed by the LIP for the TIP. After the TIP translates the code from virtual terminal format to terminal format, the message is treated as an output message in a local NPU; that is, the message is multiplexed for transmission, is sent, and is acknowledged. The acknowledgment must be formatted then as any other input message: remultiplexed, and sent upline through the local NPU to the host.

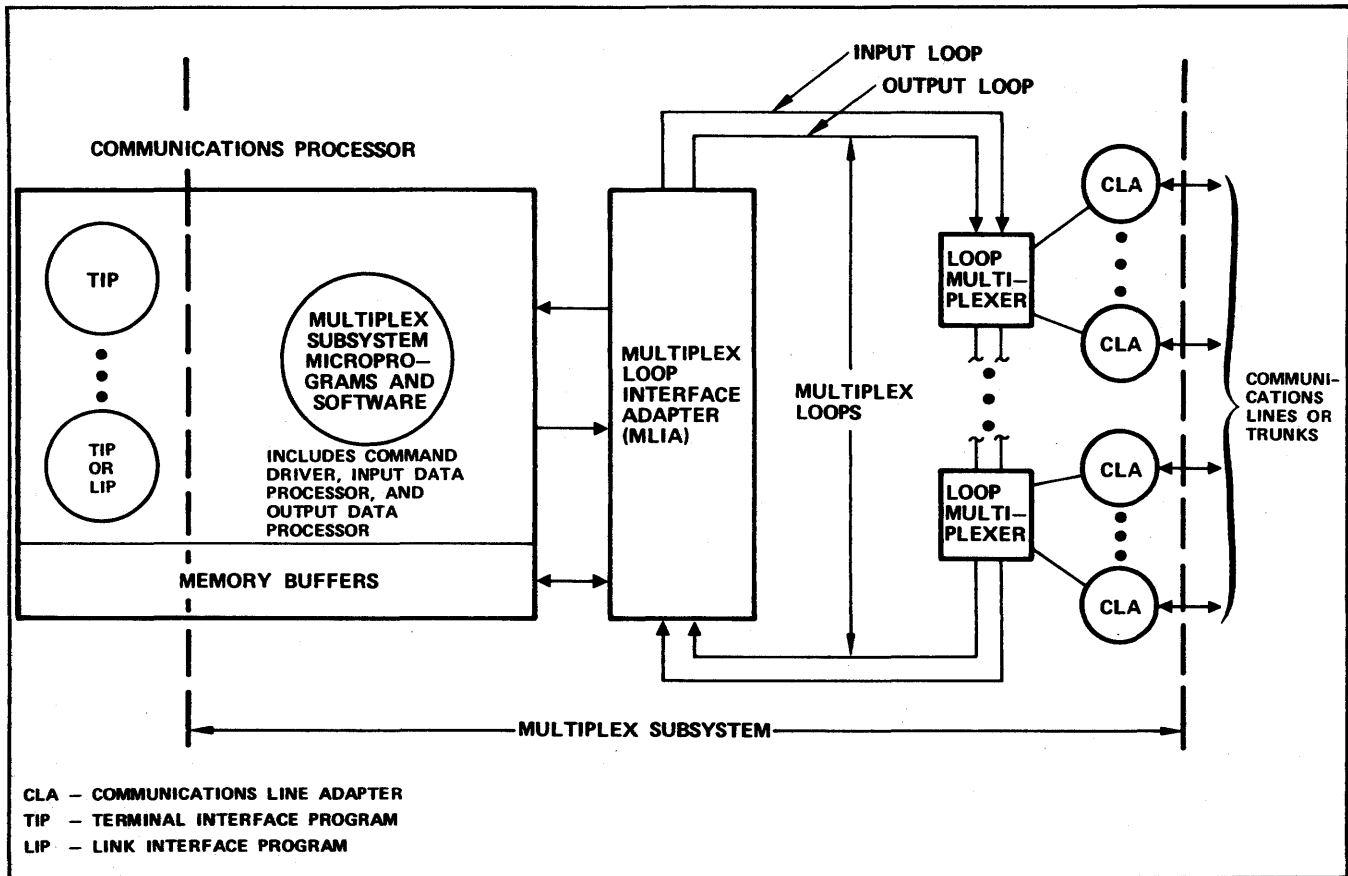

Figure 2-2. Basic Elements of the Multiplex Subsystem

Input messages (upline traffic) are reformatted from terminal to PRU or IVT format as in a local NPU, but are then sent by the LIP through the remote NPU multiplexer, received by the local NPU multiplexer, and reconstructed into complete messages in the local NPU by that NPU's LIP. It is apparent then, that through messages (non-control messages) are multiplexed twice in a remote NPU, once to/from the terminal and again from/to the local NPU.

#### Demultiplexing

For one-pass TIPs, the multiplex subsystem is responsible for picking data out of the CIB as well as for putting it into a line-oriented input buffer. When a message transmission starts, the multiplex subsystem reserves a data buffer for the message (data buffers are normally 64 words long, with 2 characters per word). The words in the CIB are identified by the line number, and are packed into a line-oriented input buffer. If a buffer is filled before the message is complete, another buffer is assigned and is chained to the first.

When the end of text (ETX or the equivalent) is detected, the TIP appropriate for the terminal type is called. It continues the processing by passing the message to the host interface package (HIP). The HIP will then pass the message through the coupler to the PPU of the host.

The demultiplexing of downline transfers is a terminal function; that is, the message is reconstituted in a buffer for the screen, printer, magnetic tape, etc.

## BLOCK INTERFACE PACKAGE (BIP)

This CCP software handles network communications. The major BIP functions are:

- Routing (switching) blocks for the CCP.
- Providing routines to handle the block protocol on the host interface side of the TIPs. Bad blocks are discarded and good blocks are acknowledged. The host senses that a downline block has been discarded by failure to receive an acknowledgment. The terminal is notified with a message when a downline block is discarded due to no connection. Some PRU and IVT formatting is also done.
- Handling failure and recovery, loading and dumping, and regulating input to the NPU.
- Providing system diagnostics. Routines send alarm messages to the network operator, and generate CE alarm messages and statistics for the host engineering file. Also, if the NPU stops, the diagnostics provide a reason code and other information concerning the stop.
- Handling the service messages which configure the network.

## BLOCK ROUTING

A major portion of this processing provides block switching so that the data block can ultimately be routed downline to the proper terminal or upline to the host.

Data traveling in either direction is tagged by the terminal ID. A group of directories are provided which assures that the block control information (contained in a header) is decoded. The block is attached, through control blocks for that line/trunk and terminal, to the next program that must process the block.

## SERVICE MODULE

The block format itself allows only a limited set of commands. Most of the large number of specific commands transmitted throughout the system are handled by the special type of command block called a service message. These messages are handled by the service module. There is a large variety of service messages (one type for each command, with a related normal response and a related error response):

- Configuring logical links, trunks, lines, and terminals, as well as the basic load/dump NPU service messages, are described in the initialization section (section 3). These messages originate in the NS or CS modules of the host for normal configuration and reconfiguration. Malfunctioning of a line or any component of the line may generate an upline service message indicating that the line or component is no longer usable. NS or CS will then reconfigure the network accordingly.
- Service messages regarding failure and recovery, and those that support diagnostics are discussed in section 4 (failure, recovery and diagnostics).
- The remaining service messages provide commands for such things as status, broadcasting a message to a terminal, or sending a message from a terminal to the network operator's (NOP) or local operator's (LOP) terminal.

## INTERACTIVE VIRTUAL TERMINAL COMMANDS

Interactive virtual terminals are capable of changing some of their operating characteristics such as page width, page length, the character to be used for breaks, backspacing, aborts and other terminal features. These command messages can originate from the host or from the terminal. The BIP supplies routines to validate the commands and to start implementation of the commands.

## BATCH TERMINAL PRU COMMANDS

Batch device operating characteristics can also be changed. There are two types of changes: those which change device characteristics (page width or length, PRU block length, and sub device type) and those which change file characteristics (file type, file limit, carriage control, punch and lace card control). Both types are sent downline from the host; the code type (026/029 punch) and transparent/non-transparent mode can also be changed by BSC/HASP batch devices. The BIP supplies routines to validate the commands and to start the implementation of the commands.

## ROUTING

Routing routines check the blocks for validity and queue the block to the TCBs if necessary. These routines also purge the data block queues when the network or a connection is reconfigured. Collectively some of the routing and queue maintenance routines are known as downline TIP services and upline TIP services.

## BLOCK ACKNOWLEDGMENT AND DATA FLOW CONTROL

The BIP acknowledges downline blocks (examples: a BACK block is generated to inform the host that a message was successfully output to a terminal by the responsible TIP, or accounting data is sent for a PRU block indicating the block was successfully sent to the terminal). Accounting data is formatted for the host when an EOI occurs.

## PROCESSING SPECIAL CHARACTERS AND IVT COMMANDS

The BIP provides routines to check special characters (cancels, breaks, interrupts) in an upline message. If such characters are found, the BIP takes the necessary action on the current message (such as discarding the current data).

If IVT commands are found, the BIP calls the IVT processor to execute the command, to change the network configuration, and to notify the host if necessary.

The programs also handle all the other kinds of control blocks except the CMD blocks which are handled by the service module.

## PROCESSING AUTOINPUT

The BIP saves the first 20 characters of an autoinput message from the host so that these characters can be used to preface the autoinput reply from the terminal.

## COMMON TIP SUBROUTINES

A number of common TIP subroutines are provided to:

- queue output blocks. The TIP is notified that output needs to be processed.
- Handle upline break signals from a terminal. Output operations are halted and the host is notified to stop sending output data on this line.
- Handle downline break from the host. The TIP will not send more input data to the host until the host is again ready to receive data for this line.
- Handle a request from the TIP to stop output data from the host for a given line.
- Handle requests from a TIP to escape to firmware processing. This is used for the text-processing operation.
- Find the number of characters to be processed.
- Save and restore TIP processing entry points so that a TIP can temporarily suspend processing while waiting for some external event to occur. The TIP may be simultaneously suspended for one output and one input operation.

- Handle a common control relinquishing request. This assures that return of control to the OPS-monitor is complete and correct.

## FAILURE AND RECOVERY

Several types of failure are possible. Each requires its own recovery or avoidance technique.

### Host Failure

If a host fails, the NPU and its software must necessarily stop message processing. Host unavailability is communicated to the other ends of all logical links. Also, the NPU sends an informative service message to all connected, interactive terminals (and to some other types of terminals) informing the terminal that the host is unavailable. After recovery, all logical links are reinitialized and new connections are made.

The host recovers the existing configuration status by means of status requests to the NPU. Initialization requires the downline-loading technique described above, followed by complete reconfiguration using the status information recovered from the NPU.

### NPU Failure

If an NPU fails, it must be reloaded and reconfigured from the host. Off-line diagnostic tests may be desirable during this period to help identify the cause of failure. Failure is detected by means of a 10-second timeout across the coupler. The NPU is forced to generate a request for load message.

Recovery consists of a dump (optional), load, and reconfigure operation. If the initial two load operations fail, the host does not request a dump after the second or any subsequent attempt to reload. After *n* successive attempts to load, the loading operation is aborted, and the NPU is ignored until manually reactivated. If the NPU is successfully loaded and initialized, NS and CS in the host set up all logical links, lines, and terminals for that NPU which the present state of the network allows.

### Logical Link Failure

Host failure, one of the causes of link failure, was mentioned previously. Link protocol failure leads to higher and higher levels of regulation until message traffic ceases on the link.

A logical link may recover spontaneously (regulation level drops), or may be reinitialized by the host. In the case of spontaneous recovery, the logical link protocol allows a restart without loss of data. Otherwise, all logical connections must be remade. Trunks connecting neighboring NPUs are a special class of links. Trunk recovery protocol is handled by the LIP.

### Trunk Failure

A trunk failure (such as the trunk connecting the NOS network to the Public Data Network) is detected by a failure of the trunk protocol. All data queued for transmission on the trunk is discarded. The failure is reported to the host. The trunk protocol detects the trunk recovery. The logical link protocol determines when the trunk can again be used for data block transmissions.

### Line Failure

Lines are disconnected and terminal control blocks (TCBs) associated with the lines are deleted. A line failure is detected by abnormal modem status or by line protocol failure. The change of status is reported to CS in the host.

A line cannot recover spontaneously. CS (which owns the lines) deletes the supported TCBs. Then CS disables and reenables the line, using the appropriate service messages. When line status changes to operational and this is reported to CS, CS attempts to configure the supported terminals.

### Terminal Failure

Terminal status is reported and messages are discarded. TCBs are not released. Once terminal failure has been detected, possible terminal recovery is monitored by a periodic status check or diagnostic poll made from the NPU to the terminal. Terminal recovery status is reported to CS.

## DIAGNOSTICS

Three types of diagnostics are associated with the NPU: inline, on-line, and off-line. Only the inline diagnostics are a part of CCP. The on-line and off-line diagnostics are a part of the network maintenance package, which is optional.

- Inline diagnostics include CE error and alarm messages, statistics messages concerning hardware performance, halt code messages that specify the reason for a NPU failure, and off-line dumps.
- On-line diagnostics provide closed-loop testing of the circuits connecting the NPUs to the terminals. These tests are available for installations purchasing a maintenance contract.
- Off-line diagnostics are hardware tests for NPU circuits. They are described in detail in the Network Processor Unit Hardware Maintenance Manual.

## INTERFACE PACKAGES

CCP provides seven standard interface packages:

- A host interface package (HIP) handles the host/NPU channel. This channel uses high-speed transfers to move 16 bits of data at a time between the PPU and NPU memories. These parallel data transfers do not use data assurance techniques since the channel's noise level is low. Data on this channel is in IVT/PRU format. The code is transparent to the HIP, except that an 8-bit byte is assumed. The interface requires a CYBER 70/170 host coupler hardware unit.
- A LIP uses a high-speed link to move messages from any kind of a terminal between a local and a remote NPU. The functions of a LIP are shown in figure 2-3.
- An ASYNC TIP services TTY-type asynchronous terminals connected to the network on low/medium-speed voice-grade lines. Terminals must be asynchronous. The TIP supports ASCII, IBM extended BCD, APL, correspondence code, and variants of these.

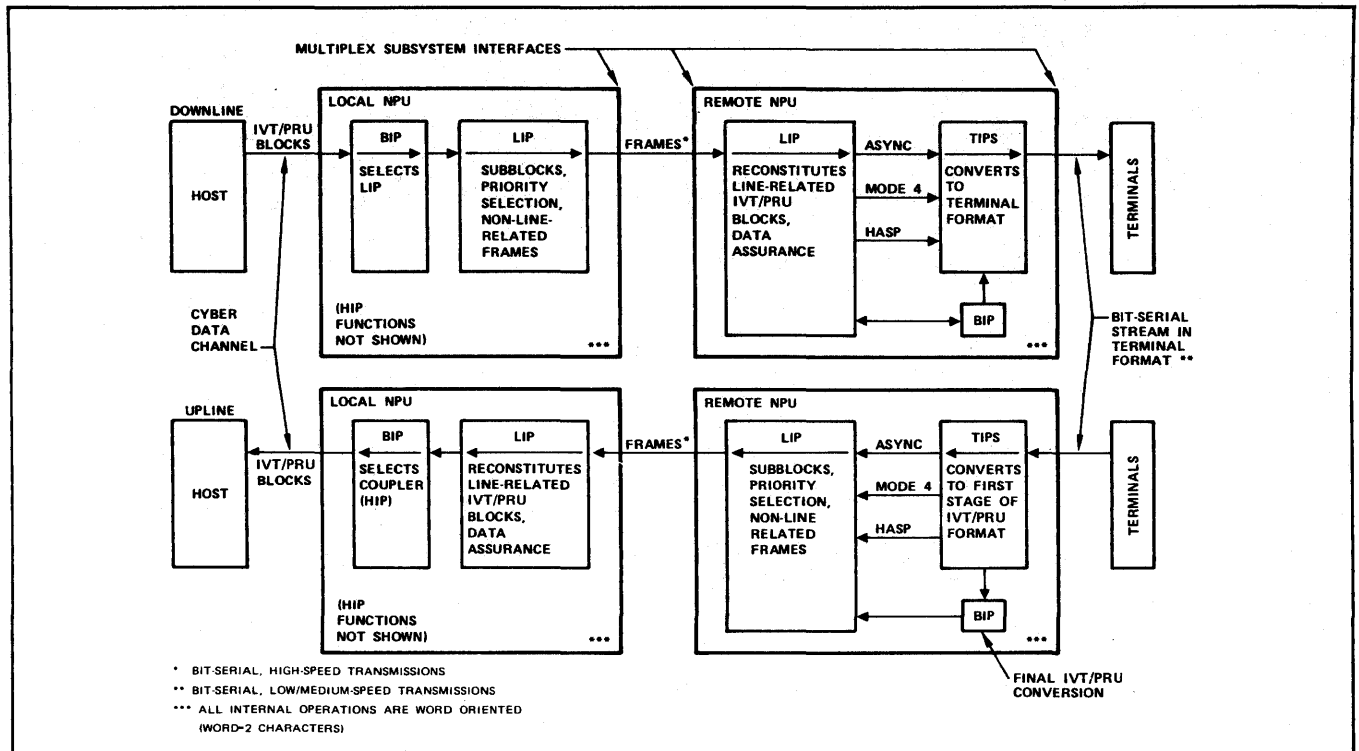

Figure 2-3. Functions of a LIP

- A Mode 4 TIP services Mode 4A and 4C terminals which connect to the network through a cluster controller (this may be physically incorporated into the terminal). The controller communicates with the NPU over a low/medium-speed voice-grade line. Transfers over a Mode 4 line are synchronous. The TIP supports ASCII and external BCD codes.
- The HASP TIP services any terminal or device connected to the network through a HASP workstation. The workstation communicates with the NPU over a low/medium-speed voice-grade line. Transfers over a HASP line are synchronous, using a variant of the BSC protocol. The TIP supports EBCDIC code.
- The Binary Synchronous Communications (BSC) TIP supports IBM 2780 and 3780 batch terminals. The terminals communicate with the NPU over a low/medium-speed voice-grade line. Transfers over a BSC line are synchronous. The TIP supports EBCDIC code.

The functions of an ASYNC, Mode 4, BSC or HASP TIP are shown in figure 2-4.

- An X.25 TIP together with a PAD subTIP services TTY-type asynchronous terminals connected to the network through an X.25 public data network (PDN). The PDN communicates to the NPU over a high-speed synchronous line; terminals communicate to the PDN over asynchronous low/medium-speed voice-grade lines. On the terminal side, the PDN must provide a packet assembly/disassembly (PAD) access. The functions of the X.25 TIP are shown in figure 2-5. The TIP supports ASCII code.

#### HARDWARE USED BY INTERFACE PACKAGES

Table 2-3 summarizes the hardware characteristics and functions of each of the interface packages.

#### SOFTWARE USED BY INTERFACE PACKAGES

Table 2-4 summarized the software characteristics and functions of each of the interface packages.

#### HOST INTERFACE PACKAGE

The host interface package (HIP) handles the protocol governing transmissions between the host and the NPU. The route of all such transmissions is through the coupler hardware. This hardware contains three registers which have status or command information, one register that contains the NPU address of the data to be transferred, and one set of lines connecting the host peripheral processing unit (PPU) buffer to the direct memory access (DMA) buffer register of the NPU.

In all cases the format of the byte in the host is 12 bits, and the associated word (2 bytes) in the NPU is 16 bits. For address and data information the 12-bit host byte does not directly use the upper four bits, making the host interface effectively an 8-bit byte. Two bytes are needed to make the associated 16-bit NPU word. For the three status-type registers (coupler status, orderword commands, and NPU status), only the lower 12 bits are used.

The NPU memory address register is set up by the NPU for upline or downline data transfer. The register is set up by the PPU when dumping the contents of the NPU to the host. In that case, the host uses the supplied address as the starting address of the next block of main memory to be dumped.

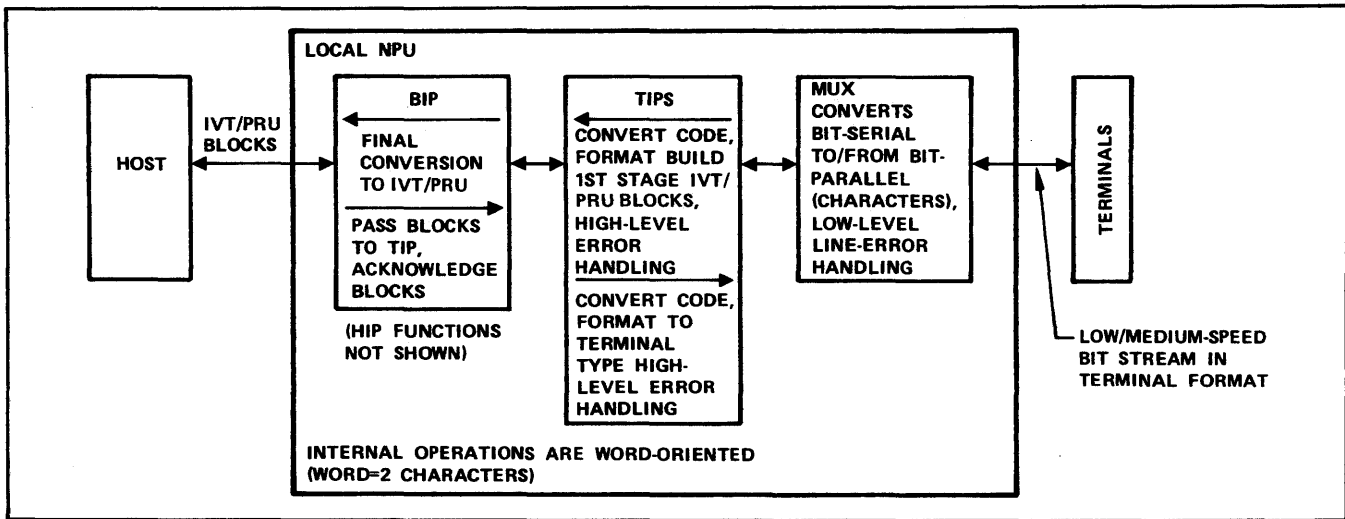

Figure 2-4. Functions of a TIP (not X.25 TIP)

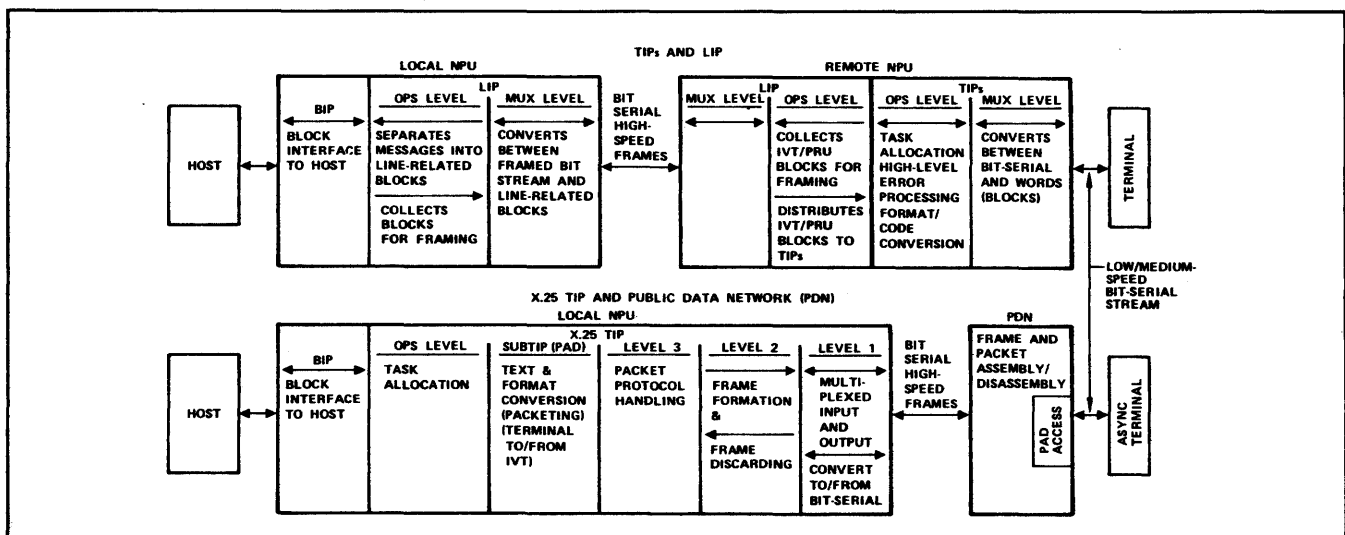

Figure 2-5. Comparison of TIP/LIP and X.25 TIP Functions

The four principal functions performed across the interface are:

- The host issues NPU start and stop commands for the micromemory processor.
- The host loads programs into the NPU to initialize it or to change its mode (overlay programs). Dumping the contents of the NPU is usually a part of downline loading from the host.
- The host or NPU sends one-word function commands to the coupler and checks status across the coupler. One of the status registers regulates transmission rate across the coupler by rejecting certain types of messages when the NPU is in danger of running low or running out of buffers.
- Blocks of data (messages) are transferred both upline and downline. Service messages are a special type of control that uses block data transfer techniques.

#### MICROMEMORY START AND STOP COMMANDS

The micromemory must be started at location zero. Both start and stop commands are a special form of service message.

#### CONTROL WORD TRANSFERS

The NPU sets function commands to the PPU in four hexadecimal bytes, using one of the status-type registers.

This allows the NPU to check switch status, chain buffers of data during transfer, clear the coupler registers, read the other two status-type registers, ready the PPU to read the status-type registers, and to set the memory address register prior to starting a data transfer.

The PPU uses a 3-bit octal code to transmit functions. These commands clear the coupler or NPU, start the NPU, input or output a program during the load/dump phase of NPU initialization, load the memory address for dump operations, and set or read the other two status-type registers.



TABLE 2-3. HARDWARE USED BY INTERFACE PACKAGES

IP	Interface		Required by	Line Type and Line Characteristics
	Device	To		
HIP	Coupler	PPU on host	Every local or front-end NPU	Channel, 16 bits parallel data plus 18 bits of address plus control/status lines. Asynchronous transfers.
LIP	Mux subsystem	Mux subsystem	Both ends of a trunk	High-speed, bit-serial full-duplex, dedicated 4-wire. Asynchronous requests, synchronous transfers. CRC-16 frame check provided.
Async TIP	Mux subsystem	TTY terminals in classes 1, 2, 4-8	TTY type terminals not connected to a public data network	Low/medium-speed, voice-grade, bit-serial, full-duplex, 2-wire, dedicated/dial-up, constant carrier. Character-oriented, asynchronous transfers. Codes: ASCII (variants), APL (variants), IBM extended BCD (variants), correspondence code (variants). Characters require start and stop bits. Character parity provided.
Mode 4 TIP	Mux subsystem	Mode 4A or 4C device	Any Mode 4 terminals in classes 10-13, 15	Low/medium/high-speed, voice-grade, bit-serial, half-duplex, 2 or 4-wire, dedicated/dial-up, constant and controlled carrier. Terminals can be consoles, card readers or printers. Terminal clusters allowed. Block-oriented, synchronous transfers. Codes: external BCD and ASCII. Longitudinal parity check on blocks.
BSC TIP	Mux subsystem	2780/3780 controller	Any BSC device in terminal classes 16 or 17	Low/medium-speed, voice-grade, bit-serial, half-duplex, 4-wire, dedicated or dial-in, constant carrier. Terminal devices operate in batch mode. Terminal can have a simulated interactive device. Block-oriented, synchronous transfers. Code: EBCDIC. CRC-16 check on blocks.
HASP TIP	Mux subsystem	HASP workstation	Any device that can connect to a HASP workstation (terminal classes 9 or 14)	Low/medium/high-speed, voice-grade, bit-serial, full-duplex, 4-wire, dedicated, constant and controlled carrier. Workstation must be an interactive device. Terminals can be consoles, card readers, printers, card punches or plotters. Block-oriented, synchronous transfers. Code: EBCDIC. CRC-16 check on blocks.
X.25 TIP	Mux subsystem	Public data network devices with PAD access	Any TTY terminal in classes 1, 2, or 5-8	High-speed, bit-serial, full-duplex, 4-wire, dedicated, constant carrier. Public data network must support packet assembly/disassembly. Frame-oriented, synchronous transfers using packetized data. Code: ASCII. Character parity can be carried in text, but is not checked. CRC-16 frame check provided.

TABLE 2-4. INTERFACE PACKAGE SOFTWARE CHARACTERISTICS

Characteristic Interface Package	Description
<p><u>Transfer Format</u></p> <p>HIP</p> <p>LIP</p> <p>ASYNC TIP</p> <p>Mode 4 TIP</p> <p>BSC TIP</p> <p>HASP TIP</p> <p>X.25 TIP</p>	<p>Host blocks. Blocks are based on an 8-bit byte in network block format. Longest IVT data block is 2043 bytes. Full PRU blocks are 640, 1280, or 1920 display code characters, or 320, 640, or 960 ASCII characters. Blocks are in chained buffers (64 words each). All data is treated as transparent.</p> <p>A variant of HDLC protocol using frames and subblocks. Maximum frame size is a build-time selection, and is normally chosen to be 1024 bytes. Subblocks based on buffer sizes. All data is transparent.</p> <p>Several variants of TTY character-oriented protocol. Input characters are gathered into blocks on the basis of a line (character string ending with a carriage return). Code translation between ASCII and terminal's code. Paper tape/cassette transfers delimited by the device on/off signal. Transparent mode is available.</p> <p>Subset of the Mode 4A/4C protocol. IVT block mode used for interactive transfers; PRUB mode used for batch transfers. Code translation between ASCII and the terminal's code. Transparent mode is available.</p> <p>Subset of the BSC protocol. IVT block mode used for interactive transfers; PRUB mode used for batch transfers. Code translation between EBCDIC and ASCII (IVT) or display code (PRU). Transparent mode is available.</p> <p>HASP protocol, a BSC protocol variant. HASP blocks with one or more records used for both batch and interactive transfers. Upline HASP blocks contain records from one or more devices. Downline HASP blocks contain records for one device. Code translation between ASCII and EBCDIC. Format conversion between HASP blocks and IVT or PRU blocks. Transparent mode is available.</p> <p>X.25 protocol (TIP level 2) uses synchronous frames containing data packets. At the terminal side of the public data network (PDN), a PAD access governed by CCITT X.3 protocol transforms asynchronous character streams into data packets and the reverse. In NPU, level 3, subTIP, and BIP transform packets into IVT blocks and the reverse. Transparent data transfers (also packetized) permitted in 1200 character blocks.</p>
<p><u>Control of Transfers</u></p> <p>HIP</p> <p>LIP</p> <p>ASYNC TIP</p> <p>Mode 4 TIP</p>	<p>A hardware handshaking routine prepares transfers. Sending side puts control information in status registers accessed by both sides; receiving side prepares for transfer on the basis of the status information. Logic is provided to resolve contention for channel use.</p> <p>Asynchronous control frames prepare transfers. All frames contain control information; information frames contain data as well. Frames are sequenced and acknowledged. Logic provided to resolve contention for channel use.</p> <p>Input messages preferred. Typeahead mode saves interrupted output messages until the unsolicited input is completed and sent to the host. No acknowledgment in either direction. Special character processing available on input except in transparent data mode. Input characters echoed on the terminal display without TIP or host participation.</p> <p>NPU initiates transfers, terminals respond through cluster controller. If terminal has an upline message, it notifies the controller which then responds to requests from the NPU (polling) to read data. Terminals in clusters are handled on a strict rotation basis, except Mode 4A printers and card readers subordinated to console (interactive and batch devices cannot be active at the same time). Special character processing for interactive input data. Print messages (PMs) interrupt printer output; host is notified so that it can send an interactive message to the terminal before printer output resumes.</p>

TABLE 2-4. INTERFACE PACKAGE SOFTWARE CHARACTERISTICS (Contd)

Characteristic Interface Package	Description
<p><u>Control of Transfers (Contd)</u></p> <p>BSC TIP</p> <p>HASP TIP</p> <p>X.25 TIP (level 2)</p>	<p>Both ends of line bid for line use (logic is provided to resolve simultaneous requests). Set up and acknowledgment blocks sent in both directions. Input has precedence over output and can suspend output until input completes. Interactive transfers have precedence over batch transfers. Handles print messages as for Mode 4 TIP.</p> <p>Each terminal has its own data stream. Permission to use the stream is granted by the HASP workstation. Upline, HASP workstation determines device to be used. Set up and acknowledgment blocks sent in both directions. Special character processing for interactive input data. Idle blocks are exchanged when lines not sending data/control information. Handles print messages as for Mode 4 TIP.</p> <p>Asynchronous control frames prepare transfers. All frames contain control information; information frames contain data as well. Frames are sequenced and acknowledged. Logic provided to resolve contention for channel use.</p>
<p><u>Data Movement</u></p> <p>HIP</p> <p>LIP</p> <p>ASYNC TIP</p> <p>Mode 4 TIP</p> <p>BSC TIP</p> <p>HASP TIP</p> <p>X.25 TIP</p>	<p>Direct-memory-access (DMA) data transfers through the host coupler. Transfers are asynchronous.</p> <p>Sending side puts data into subblocks and packs subblocks into frames. Frames are numbered. Receiving side unpacks frames and restores data to block format. Transfers are bidirectional and synchronous within the frames.</p> <p>Data is transferred one character at a time; parity is optional. TIP packs input characters into a block. Block is sent upline when block delimiter is received. When a downline line is ready for transfer, entire logical line is output without interruption unless unsolicited input occurs.</p> <p>Data is transferred to/from Mode 4 controller in Mode 4 blocks. Controller routes data to/from terminals. TIP supplies downline formatting for interactive blocks, and converts interactive input into IVT blocks. TIP breaks PRUBs into output blocks, and assembles input batch data into PRUBs. Trailing blank truncation for card input devices. Accounting data for batch devices is generated both upline and downline.</p> <p>Data is transferred to/from BSC controller in blocks. BSC control function routes data to/from terminals. TIP supplies downline formatting for interactive blocks, converts upline interactive data to IVT blocks. TIP breaks PRUBs into output blocks, and assembles input batch data into PRUBs. Accounting data for batch devices is generated both upline and downline.</p> <p>Data is transferred to/from the HASP workstation in HASP blocks. Upline, several terminals can interleave records in a single HASP block. HASP TIP sorts upline records by connections. TIP moves an interactive record into an IVT block; TIP assembles batch records into full PRUBs (exception: partially full PRUBs contain end of input). Downline HASP blocks have a single record. PRUBs may be broken into several HASP blocks. In non-transparent mode, interactive data is translated between EBCDIC and ASCII in both directions, and batch data is translated between EBCDIC and display code in both directions. Downline data compression is supplied for batch devices; upline data expansion is performed on compressed data. Accounting data for batch devices is generated both upline and downline.</p> <p>Downline, subTIP handles conversion from network blocks to packets. Packet level (3) provides groups of packets for level 2. Level 2 frames packets (packets from different channels are not mixed in one frame) and transmits to PDN. PDN/PAD access is responsible for dismantling frames and packets and moving data one character at a time to terminals. Reverse process converts terminal data to IVT blocks.</p>

TABLE 2-4. INTERFACE PACKAGE SOFTWARE CHARACTERISTICS (Contd)

Characteristic Interface Package	Description
<u>Error Handling</u>	
HIP	Keep-alive messages assure that channel is available. Recoverable errors are retried (data parity errors, hardware timeouts, abnormal termination of transfer) until host stops NPU and reloads. Irrecoverable errors (memory parity error, memory protect error, or broken chain of buffers) stop NPU. Host then reloads NPU. Block sequencing is provided by the agreement between host application and terminal.
LIP	An exchange of receive-ready messages assures that the channel is available. Frames are rejected for noise (bad CRC-16 check), for bad command/response format, for timeouts, or for being out of sequence. In all cases, the bad frame and all succeeding frames are retransmitted.
ASYNC TIP	Input with bad parity marked but accepted. No retransmission in either direction.
Mode 4 TIP	TIP handles timeouts, protocol errors, bad commands, parity errors, and transmission errors reported by the receiving terminal. In all cases, retransmission is attempted. If this fails, message movement stops, but attempt is made to restart normal transfers.
BSC TIP	For upline data, the TIP recognizes timeouts, bad acknowledgments, and illegal formats. Bad blocks are reported to the sender by a NAK. For downline data, the TIP recognizes a transmission failure when it receives a NAK or detects a transmission timeout. Attempts to retransmit data are made unless an error threshold is exceeded. In that case, transmissions are aborted. Bad autorecognition data causes a message to be sent to the terminal.
HASP TIP	For upline data, the TIP recognizes timeouts, bad control commands, CRC-16 errors, and illegal HASP block formats. These are reported to the sender with a NAK block. For downline data, the TIP recognizes a transmission failure when it receives a NAK block. In all cases, an attempt is made to retransmit data. If this fails, line is marked inoperative and the host is informed.
X.25 TIP	<p>At packet level, detecting a missing packet causes a channel reset. Packets traveling in the same direction are discarded; no action is taken for data traveling in the opposite direction.</p> <p>At the frame level, frames are retained until acknowledged. Out-of-sequence errors cause all unacknowledged frames to be retransmitted. Other errors (bad commands/responses, overlength frames, wrong sequence number) cause the link to reset. Following resetting, all unacknowledged frames are retransmitted. In case the link is in an unknown state, it is disconnected and then reconnected. In this case, all frames are discarded at disconnect time.</p>
<u>Flow Control and Regulation</u>	
Host	Input to host is controlled by host resource allocation. Host rejects long blocks (size greater than 256 bytes) first, then shorter blocks.
HIP	Host output: Controlled by availability of NPU buffers. Low priority transfers are regulated first, then high priority transfers, and finally service messages. In extreme cases, all output from the host is rejected.
LIP	Low priority traffic regulated first if there is a shortage of NPU buffers; then high priority traffic regulated. Sending LIP responds to receiving LIP's requests for regulation.
ASYNC TIP	Input traffic is rejected if there is a shortage of buffers or if host is unavailable. A canned message notifies the terminal user of regulation; another message indicates when the host is again available.

TABLE 2-4. INTERFACE PACKAGE SOFTWARE CHARACTERISTICS (Contd)

Characteristic Interface Package	Description
<p><u>Flow Control and Regulation (Contd)</u></p> <p>Mode 4 TIP</p> <p>BSC TIP</p> <p>HASP TIP</p> <p>X.25 TIP</p>	<p>Input traffic: TIP stops polling for data if there is a shortage of NPU buffers or if host is unavailable. Keyboard is locked when the send signal is entered from terminal so operator cannot attempt additional input. Terminals again polled for the data when regulation ends.</p> <p>Output traffic sent without regulation.</p> <p>TIP stops input by sending WACK blocks (if the input has started when regulation conditions start) or by sending an EOT (if regulation conditions exist when terminal starts input).</p> <p>TIP stops all input by sending a wait signal on every active data stream if shortage of NPU buffers or host is unavailable. If a terminal requests that no more data be sent on the data stream, NPU passes message to host. Other terminals continue to receive data.</p> <p>Both input and output are controlled on three levels.</p> <p>Input, subTIP level: regulated by host's ability to accept blocks or by buffer shortage. SubTIP requests level 3 not to send additional packets. When shortage ends, subTIP restarts the packet level.</p> <p>Input, level 3: stops acknowledging packets if requested to stop by subTIP. PDN stops sending packets when n packets are unacknowledged.</p> <p>Input, link level: if buffers are unavailable, level 2 does not acknowledge frames. PDN ceases sending frames when n frames (n is a subscription option) are unacknowledged; these unacknowledged frames are acknowledged when buffers are again available.</p> <p>Output, link level: level 2 ceases sending frames when n frames are unacknowledged; starts sending frames again when there are less than n unacknowledged frames. Requests are made to level 3 for information blocks (packets) when the level 2 output queue has room.</p> <p>Output, packet level: packet level flow is controlled by PDN failing to acknowledge packets. When the limit (n) is reached, level 3 ceases to send packets and does not request more data for the subTIP.</p> <p>Output, PAD access level: PAD subTIP sends data blocks on request from level 3. Network blocks are acknowledged when data is sent to level 3.</p>
<p><u>Autorecognition</u></p> <p>ASYNCR TIP</p> <p>Mode 4 TIP</p> <p>BSC TIP</p> <p>HASP TIP</p> <p>X.25 TIP</p>	<p>Provided for terminals operating on lines up to 1200 baud. Includes line rate and code set.</p> <p>Autorecognition is provided for cluster address, for code type, and for mode type (4A or 4C).</p> <p>Sign-on blocks (* /CONFIG card) are used for autorecognition.</p> <p>Sign-on blocks (* /CONFIG card) are used for autorecognition.</p> <p>Autorecognition does not apply.</p>

TABLE 2-4. INTERFACE PACKAGE SOFTWARE CHARACTERISTICS (Contd)

Characteristic Interface Package	Description
<b>Autoinput†</b> <b>ASync TIP</b> <b>Mode 4 TIP</b> <b>BSC TIP</b> <b>HASP TIP</b> <b>X.25 TIP</b>	<b>Supported</b>  <b>Supported</b>  <b>Supported</b>  <b>Supported</b>  <b>Supported</b>
†Saving the first 20 characters of the output message and appending the input response up to the length of a logical line.	

**STATUS WORD TRANSFERS**

The control word is set indicating that one of the status-type registers has been loaded and can be accessed by the unit on the other side of the coupler. The unit interprets the control word, reads the status, and acts on the status information.

The register used for regulation has three status values: transmit all messages to the NPU (buffer level is above threshold, so that buffers can be assigned to receive data as rapidly as the host can transmit data); do not transmit messages for batch-type devices (buffer availability is critical, so the heavy demands of chained buffers for batch-type messages pose a potential hazard of exhausting the NPU data buffer supply—which causes an unconditional NPU halt); and transmit-only service messages (neither batch nor interactive data transfers are allowed; the only transfers remaining are command/network coordination service messages—all service messages are short and can fit in a single data buffer of the largest size). Note that all messages use the direct memory access (DMA) channel of the NPU.

**DATA TRANSFERS**

For downline transfers, the NPU has assigned the next data buffer, set up buffer chaining (if necessary), and will receive sufficient information in the data block header to switch the block to the proper internal handling or terminal/line/TIP.

For upline transfers, the full message (which may be in several chained blocks) is ready. The NPU makes the address of the first block in the chain available. As the blocks are transferred, the chaining bit is inspected. If set, when one block is transferred, the starting address of the buffer holding the next block is set in the address register.

Handling of the block protocol on both sides of the coupler will cause generation of acknowledgment service messages. This is not a HIP function on the NPU side.

Since the DMA/PPU buffer channel is half-duplex (data can be sent in only one direction at a time), contention for channel use is normally resolved in favor of outputting blocks from the PPU. However, following this transfer, the protocol provides a 10-millisecond period during which the NPU can request channel use without the PPU contending for channel use.

No attempt is made to resend transmissions of less than block length. A bad block is rejected in its entirety; with it, the message is rejected. For this reason an entire message is retransmitted regardless of the number of blocks composing it. The message handlers on both sides of the coupler (that is, the NAM in the host and the HIP in the NPU) are responsible for retaining messages until they are acknowledged as received.

**LINK INTERFACE PACKAGE**

The link interface package (LIP) module handles transmission and reception on both ends of a trunk; therefore, a copy of the LIP must exist in both the local and the remote NPU.

The LIP implements a class of the Control Data Corporation Control Procedure (CDCCP) for information interchange. The specific protocol implemented is similar to ISO HDLC class: a symmetrical, asynchronous response mode (ACM), with basic numbering range having two-way simultaneous reject and initialization options (SAB, 2, 5).

Two major types of operations are handled by the LIP: loading/dumping the remote NPU, and processing data transmissions over the trunk. Data message transmissions across the trunk use a unit called a trunk transmission frame (TTF or frame).

There are three types of frames:

- unnumbered frames which establish the basic transmission states between the two nodes (such as utilization, disconnect, command rejected)
- supervisory frames that establish whether transmission/reception is currently possible (ready for data, not ready for data, or rejected last data sent)
- information frames used to transmit message data; this class of frames includes frames that are carrying service messages

Both frame size and data block size are customization time selections. The information frames themselves are composed of one or more subblocks. Each subblock is a buffer of information related to a single message so that the frame may be considered as a pocket of information subblocks containing one or more message parts for one or more terminals.

Use of overlay areas is controlled by the host, using information from the NPU. During normal processing, the NPU uses all of main memory. However, for rarely used operations such as initialization, a portion of the main memory which is normally reserved for assignable buffers is instead reserved for special programs. These programs are temporarily overlaid in memory and are executed on-line.

Terminal message data is always in virtual terminal format when it is placed in a frame; that is, upline data must be processed by a TIP in the remote NPU before it is sent over the trunk, and downline data is not processed by a TIP until after it is transmitted over the trunk.

Either end of the link may initiate data transmission when conditions warrant. Once the interfacing LIPs have established the normal mode, data transmission can begin.

To understand the LIP requirements for message processing, it must be remembered that a remote NPU has no coupler to the host, and therefore no HIP. Terminal data passes through the multiplexer twice: once in terminal format as it passes between the terminal and the NPU, and once in IVT or PRU as it passes between local and remote NPUs. Upline data in the remote NPU is demultiplexed and passed to the appropriate TIP for conversion to IVT or PRU format. Completed, converted messages are passed to the LIP for framing and then passed through the multiplex subsystem, over the trunk to the local NPU. Trunk transmission rate is up to 19200 bps.

In this local NPU, upline data from the trunk is received by the LIP and reconstructed into a message in (chained) buffers. Then it is passed to the HIP for transmission to the host. Downline data is taken from a trunk message data buffer, assembled into frame format by the LIP and sent to the remote NPU. Once it is demultiplexed by the LIP/multiplex subsystem, it is in IVT or PRU format and is ready to be passed to the appropriate TIP for conversion to terminal format and processing.

#### LOADING/DUMPING OF REMOTE NPU

The local NPU must process the load/dump operation in its overlay area. The program information is transmitted to/from the local NPU overlay area in block form. The local LIP passes the programs (downline) and receives main memory contents (upline) in frame format. The remote NPU LIP is responsible for stripping the frame information from the downline subblocks and loading these subblocks (parts of programs) at the location indicated by the host. For dumping, the LIP is responsible for placing the main memory contents, starting at the address indicated by the host, into frames and sending the frames to the local NPU.

Configuring the remote NPU is handled by service messages, as in the case of configuring a local NPU. The service messages are transmitted across the trunk in the same manner as any other message data.

#### TRUNK TRANSMISSION PRIORITIES AND REGULATION

A high or low priority is assigned to each frame. This is the same priority scheme discussed previously for NPU regulation: high priority is associated with interactive terminals and low priority is associated with batch terminals. Each time a new frame can be transmitted the LIP scans the high and low priority queues. If high priority data is waiting, it is always transmitted ahead of low priority data.

On input (in either the local or the remote NPU), data from the multiplex subsystem which services the trunk can be rejected if the number of available buffers has dropped to the threshold level. First low-priority traffic is rejected, then high-priority traffic. Supervisory frames are not included in this priority scheme. These frames contain some command/status information, but do not include most service message instructions which are treated as high priority. Thus, some service messages can be rejected while other command/status information still passes over the trunk.

#### TRANSMISSION ASSURANCE

The CDCCP protocol requires that each frame be acknowledged. Since several frames may have been transmitted before an acknowledgment for a given frame is generated, all frames up to and including the last properly acknowledged frame are retransmitted. No frame is released from the sending NPU until it is properly acknowledged. Frame checking is provided by a cyclic redundancy checksum (CRC) which is generated by the sending LIP and included at the end of each frame.

#### TERMINAL INTERFACE PACKAGES

A terminal interface package (TIP) interfaces the terminal data (messages) to the network. The TIP's interface to the terminal or a controlling device is through the hardware, firmware, and software of the multiplex subsystem. The TIP's interface to the system is through line control blocks (LCBs) and terminal control blocks (TCBs). A user interface allows the terminal operator to change an interactive terminal's parameters (such as page width and length, cancel and break characters, and others).

Each TIP has the general ability to handle the protocol for its terminal type. Specialized additional information for any real terminals that do not fit the basic TIP processing pattern is contained in the TCB for that terminal. This gives the standard TIPs sufficient flexibility to handle many terminal variations.

A TIP includes both hardware and software elements. In interfacing with the communications network, the principal concerns of the TIP are mode control and error control with most of the software elements devoted to exception processing.

Batch and interactive protocols are treated differently:

- For interactive output in TIPs which support only interactive devices, IVT data is queued to the TIP which converts format and code and then passes the information directly to the terminal (ASYNC TIP) or to another network (X.25 TIP).
- For other protocols, downline IVT blocks or PRUBs are transformed into terminal transmission blocks and are then returned to the BIP. The BIP requeues the blocks to the terminals in interactive or batch queues. The TIPs pass the blocks to the terminals through the multiplex subsystem.
- One upline TIP (ASYNC) converts input data directly into IVT blocks and passes this to the host. Other TIPs have multistage upline processing. During the first stage, data is collected. During later stages data is formatted in PRUBs or IVT blocks as appropriate. At the same time, data on channels which service more than one device have the data segregated by connection number.

- Methods are supplied for either the terminal user or the host to interrupt messages.

## ASYNCR TIP

The asynchronous TIP supports dedicated and dial-up asynchronous lines servicing teletypewriter-like terminals operating at standard rates in the range 110 to 9600 baud.

The TIP supports the following codes: ASCII, Teletypewriter-paired APL ASCII, Bit-paired APL ASCII, External BCD, External BCD APL, Correspondence, and Correspondence APL. Transparent mode is also available.

The TIP provides software support for teletypewriters, for 2741 terminals, and for teletypewriter-compatible CRTs operating in an interactive mode with host applications programs.

There is a build-time option that excludes support of the IBM 2741 terminals and terminals which use APL code. This option makes a considerable amount of additional NPU memory available for message processing. If the user attempts to use APL features that were not included in the build, a rejection message is generated by CCP.

The interface between the host and the TIP is handled by the interactive virtual terminal. The TIP handles the interface to the terminal through the multiplex subsystem.

The Async TIP supports a terminal-to-virtual transform for seven types of terminals. To expand the usefulness of this TIP, a method is provided for the user at a terminal or a connected application to vary parameters and operating modes for any of the seven terminal types. This provides terminals which differ in detail from the terminal types. The terminals explicitly supported by the Async TIP and the seven associated classes are:

<u>Terminal Class</u>	<u>Manufacturer</u>	<u>Model Number</u>
1	Teletype	M33, 35, 37, 38
2	CDC	713-10
4	IBM	2741
5	Teletype	M40/2
6	Hazeltine	2000
7	CDC	LIAT 751, 752, 756
8	Tektronix	4014

Line types supported are:

- dedicated or dial-up
- two- or four-wire
- full-duplex

The terminal type is supplied by the user at the terminal or by the host software, as are any further variable parameters or modes. The TIP is prepared to receive input at all times (type ahead mode); therefore, the TIP attempts to deliver output whenever available, unless input is currently active, a page-wait condition exists, or an auto-input block has been output and the reply information (which must be placed in the output block) has not been returned with the requested information. When input is detected during an output cycle, the TIP suspends output operation. Later, this output is sent from the beginning of the logical line, unless the input was one of the user break commands.

IBM 2741 keyboards are locked after each logical line is input and the TIP does not unlock the keyboard until one or more messages have been output. Therefore, if an operator at a 2741 terminal wishes to use the type ahead mode when the keyboard is locked, he must press the ATTN key to unlock the keyboard so that the type ahead data can be entered.

Operators at all terminals have the responsibility for not using the type ahead feature if either auto-input or special edit mode (see appendix H) are currently being used.

All input and output in the character mode is transformed between the terminal and virtual terminal characteristics (code conversions, format effectors, format effector delays, line delimiters, special character recognitions, etc.). The transparent mode is available to suppress this transform where desired.

Autorecognition allows the TIP to determine both the terminal's transmission rate (if the rate is between 110 and 1200 baud) and the terminal's current code set. To activate the autorecognition function, the user at the terminal presses the carriage return key after the connection is established. This generates the appropriate character at the terminal, which is placed on the line at the terminal's normal line speed. The TIP samples the line at 800 baud. Depending on the speed of the line, one or more different characters will be sensed by the TIP. The TIP uses the received character to detect the true transmission speed of the terminal.

After the TIP resets the communications line adapter to the correct baud rate, the TIP sends the terminal two line feeds to inform the operator that character set recognition can begin. The operator responds by pressing the ) key and then a carriage return (ASCII terminal operators have the option of pressing only the carriage return).

If the TIP detects a terminal using a code set that is supported by the TIP but not available in the current variant, the terminal receives the message, "UNSUPPORTED CODE SET." This message is sent in the terminal's code set.

After determining the code set, the TIP sends two more line feeds to the terminal to inform the operator that autorecognition is complete. At the same time, the TIP sends a line operational service message to the host. This message contains the line speed and terminal character set. See appendix C of the CCP System Programmer's Reference Manual.

The user has one minute to enter each of the requested responses. If he fails to do so in this period, or if the code set is unsupported in the CCP variant, the line is disconnected.

Any terminal operating at a speed greater than 1200 baud must be dialed into a port where the communications line adapter is designed to operate at that particular speed.

## Input Processing

The basic input is the logical line (data followed by line feed/carriage return) or a physical line width of the device (number of characters in the line; for instance an 80-character line width on the CRT). Output is allowed only when input processing has a pause longer than 200 milliseconds following a line end. Output is interrupted if input starts during an output operation.



Parity is checked and the parity bit is stripped from the data character. Certain other control characters are discarded from the data (e.g., nulls). The input data in whatever form is converted to 7-bit ASCII form unless transparent mode has been selected.

Backspacing control is provided. Input characters within the current line which are corrected by subsequent backspacing are discarded.

The operator can cancel the current line by entering the cancel character (see appendix H for definition of the character). The TIP discards the line and confirms the change by sending a \*DEL\* message to the operator. Note that if the terminal is in special edit mode (appendix H), backspace, linefeed, and cancel characters are sent to the host as data; the TIP does not perform the control action which these characters usually cause.

Auto-input is provided. The output block is held while the terminal operator generates input data in response to output data. Then the first 20 characters of the output data are chained to the front of the input block and all of this data is returned to the host as the new input data stream. Further outputs are inhibited until the responsive input data is generated. The operator may stop the auto-input mode.

For keyboard inputs, the TIP provides logic to process line feed, carriage return, cancel, start of text, and upper/lowercase shift. Paper tape input is supported.

**Output Processing**

A single data block may contain several logical lines. The TIP fills the lines with nulls as required. Paging format effectors (FEs) are supported, as are upper/lowercase shifts. The TIP converts the ASCII terminal code from the IVT character set to the character set of the terminal.

A page-wait option feature for CRT output allows the user to view the display as long as he wishes. A page-over feature warns the viewer that there is more data in the message even though the current page is not full. Paper tape output is supported.

**User Interface**

The TIP supports the standard message input and output formats for TTY devices. The TIP also allows the operator at an interactive device to change some parameters during IVT processing. The commands and their effects are given in appendix H.

**MODE 4 TIP**

The Mode 4 TIP interfaces devices using Mode 4A or 4C protocols to the network. Not all features of the Mode 4 protocols nor all features of supported terminals are used. A typical Mode 4 device would be the card reader, printer, keyboard, and CRT display of a CDC 200 user terminal (UT). Mode 4 devices that have card readers and printers as optional devices are considered to be 200 UTs even though they may actually be CDC 731, 732, or 734 terminals.

Table 2-5 shows the Mode 4 equipment supported by the TIP and the mode and associates each device with batch or interactive operation. Some variations exist in the terminology associated with Mode 4 devices. Table 2-6 presents the equivalent terms.

TABLE 2-5. MODE 4 COMPONENTS

Terminals		Devices	
Type	ID	Type	ID
4A	200UT	CRT & Keyboard Printer Card Reader	Interactive Batch Batch
	731	CRT & Keyboard Printer Card Reader	Interactive Batch Batch
	732	CRT & Keyboard Printer Card Reader	Interactive Batch Batch
	734	CRT & Keyboard Printer Card Reader	Interactive Batch Batch
4C	711	CRT & Keyboard	Interactive
	714	CRT & Keyboard Printer	Interactive Batch

The TIP is insensitive to line speeds; it supports synchronous lines operating at rates up to 19.2K bps. Lines may be dedicated (with or without a transceiver) or switched (dial-up) with a modem. Lines are considered to be half-duplex; that is, the TIP is either transmitting to the line or receiving from the line, but not both simultaneously.

TABLE 2-6. MODE 4 TERMINOLOGY

Nomenclature Used in this Manual	Mode 4A Nomenclature	Mode 4C Nomenclature
NPU	data source	control station
cluster address	site address	station address
cluster controller	equipment controller	station
terminal address	station address	device address

Each line can have more than one cluster of equipment and each equipment cluster can have more than one terminal. Lines with multiple clusters must be dedicated. Where multiple terminals are on a line, the TIP services each terminal in sequential order without priority.

All Mode 4 terminals can have both interactive and batch devices attached. The Mode 4 TIP supports remote batch terminals as separate but dependent devices. The dependencies are reported to the host on demand when a conflict occurs.

#### Mode 4 Autorecognition

The TIP performs autorecognition when requested by the host. This procedure determines the code set of the terminal (ASCII or external BCD) and mode (Mode 4A or 4C). Autorecognition causes the TIP to return a service message to the host which contains the following information:

- terminal type
- cluster address
- terminal address
- device type

Multicluster autorecognition is not supported.

Autorecognition first determines the cluster address. A poll message allows the caller to hear an audible tone. The modem is allowed time to stabilize after the Modem Data switch is depressed.

To complete autorecognition during dial-up procedures, the remote operator presses the SEND key on at least one of the displays in the cluster. This allows code set recognition through the use of an escape code in a read message.

If the terminal uses BCD code, autorecognition is complete at this point. If the terminal uses ASCII code, the TIP sends a configuration poll. An error response or no response indicates the terminal is Mode 4A. A read response indicates the terminal is Mode 4C.

A line status (operational) service message is sent to the host to complete autorecognition.

#### Mode 4 Data Handling

Interactive data is passed to/from the IVT interface; batch data is passed to/from the PRU interface.

- **Input data:** the TIP polls the terminal to collect data that is ready to be input. The host requests polling, but the TIP controls the actual polling for data. A further throttling of input can occur if the NPU is regulating data input as a result of a low buffer availability condition.
- **Output data:** the TIP delivers interactive output to the display and batch output to a printer. Output is delayed if the printer is not ready.
- **Error processing:** the TIP performs recovery for line or terminal errors. If immediate recovery is not possible, the TIP reports the error to the host.

#### Host Interface

IVT or PRU blocks are used at the host interface. The TIP processes each line as an independent data channel. Devices on a terminal are checked for data in the sequence the devices were configured. The card reader and printer of the 200 UT are treated as separate terminals, but the console must be configured before the card reader and printer can be configured.

The terminal status of Mode 4C terminals is solicited before the TIP services devices on the terminal. The terminal returns the status of all the connected devices when requested. Console status indicates whether a read message is requested. Printer status indicates ready or busy condition. Status is saved in the TCB and is used to determine the action to be taken when subsequent events occur.

#### IVT Interface

The IVT interface to the Mode 4 TIP supports the CRT and keyboard which are collectively referenced as one device, the console.

#### Selecting the Mode 4 Console

Console activity is started by a start input command, console output data, or an input batch interrupt for the console. Console activity remains active and the TIP polls for input. Upon arrival of batch start or resume commands, console activity ceases and batch activity commences. When batch activity ceases due to normal processing of end of data and no further data is present, the TIP sends a clear write to the console and starts polling the console for input.

For the Mode 4A terminals, using the console interrupts the card reader connection and the printer connection. The TIP inhibits any further batch input or output activity until it receives a resume type of command from the host.

#### Mode 4 Interactive Input

When a start input command is issued to a Mode 4A terminal, the cursor is moved to the left-most character position. This command also clears the terminal transmission buffer of any previous card or print block. Polling for input continues until the terminal is deleted from the system configuration, an error occurs, buffer regulation occurs, logical link regulation occurs, or a stop input command is received. A stop (STP) block is sent whenever a communication error is detected; a start (STRT) block is subsequently sent when the error condition disappears.

The TIP polls the Mode 4C console for input only when a read request is indicated in the terminal's status.

It is possible for parts of a message to repeat on a 711 terminal in certain types of error conditions.

The operator can cancel part of a line by using the CN character (see appendix H). If this capability is used, the TIP confirms the cancellation by sending a \*DEL\* message to the interactive device. See appendix H for the alterations to the IVT interface which may be entered from a terminal.

Interactive input from the console can include multiple logical lines. The lines are separated by CRs.

The TIP allows autoinput. The first 20 characters of the autoinput message from the host are saved and are prefixed to the reply from the console.

The TIP supports transparent input, but this input applies only to the first message following transparent selection. The Mode 4 frame control characters are removed, but no other translation occurs. The cursor is not repositioned to the left margin following each input, and the keyboard is not unlocked. Since any further polling would result in retransmission of previous data, polling ceases. The host must request that polling resume by sending output or a start input command.

The TIP removes any E2 or E3 codes from Mode 4A cluster transparent data. The data is processed without transforms. E-codes and MTIs for Mode 4 protocol are described in the CCP System Programmer's Reference Manual.

An operator at a Mode 4 console can change the following IVT parameters for his terminal:

- Terminal class
- Page width and page length
- The characters used for cancel, IVT control, and user breaks one and two
- Input device for transparent mode (Mode 4C only)
- Page wait feature

The operator can also send a message to the NOP console.

Each IVT command (including the message to the NOP console) is preceded by the control character and followed by a carriage return or an end of message. Multiple line inputs can have an IVT command only in the first line. If the IVT command in a multiline input is a request for transparent input, transparency will not be applied to the current set of input lines, but will be applied to the next message.

#### Mode 4 Interactive Output

The cursor is returned to the left margin following each output of a logical line. For a Mode 4A console, any ASCII control character is replaced with a blank, and lower case characters are folded into upper case. For a Mode 4C console, a full 128 ASCII character set is supported.

The format effector transforms performed by the TIP for both interactive and batch devices is given in the CCP System Programmer's Reference Manual.

The IVT transform is not performed on transparent output data. However, the Mode 4 frame control is added to the data, but no code or format effector conversion is performed. The parity bit for each character is also added before the data reaches the line. Autoinput and page wait are supported for transparent data. However, page wait occurs following each MSG block only.

The console operator requests a message break by using either the user break one or two character.

The page wait feature assures that output is delivered at a readable rate. Data from the host is displayed on the screen until the end of page is reached. Page turning is accomplished whenever the console operator responds with a request for the next data display.

#### Card Reader Interface

The Mode 4A card reader is activated by sending a command to the TIP to start accepting input. The TIP polls the card reader for data.

Upline data is translated and trailing spaces are stripped to the first even character boundary following the last data character. The data is stored in buffers which are subsequently passed to the BIP. The BIP builds the PRUBs to be transmitted to the host.

The TIP indicates end of card in standard host file format. If the last non-blank character is on an odd character boundary, one blank is inserted. Two to ten binary zeros are then added to insure that the host can decode end of card and also to insure that the data stream ends on a modulo ten character boundary. If the last data character of the card is a colon in the 64 character set, the TIP inserts one or two spaces.

The TIP counts each card. Polling continues until an abort input occurs, a slipped card is detected, a console interrupt occurs, the card reader becomes not ready, or an EOI card is read (6, 7, 8, 9 punch in column 1 or /\*EOI in columns 1-5). The TIP handles these events as follows:

- Abort input: card reading stops and accounting data is sent to the host. If the printer is not active, the TIP polls the console. If the printer is active, the cluster remains in batch mode. Card reader input restarts upon receipt of a start input command from the host.
- Slipped card: host is informed with an input stopped, card slip command.
- Card reader not ready and last card read not an EOI card: the TIP stops polling and notifies the host. Polling resumes when the TIP receives another start input command from the host.
- Console interrupt: the TIP reports that input is stopped and sends a batch interrupt to the host. Card reading resumes when the host sends a resume input command.
- EOR card read: TIP checks columns 2/3 or 6/7 for level number and adds this information to the PRUB. Since an EOI or EOR card ends a PRUB, it is possible for a short PRUB to be sent to the host.
- EOI card read: the current data, including accounting data (card count), is sent to the BIP. The BIP passes the data to the host in a PRUB and the TIP continues polling. If an EOI is read and the card reader is found to be not ready (empty), the TIP notifies the host that the card reader is at end of a data stream. To get more card data, the host sends another start input command to the TIP.

## Printer Interface

The printer is activated by sending downline PRUB data to the BIP. The BIP passes the PRUB to the TIP. The TIP transforms the PRUB into transmission blocks (blocks of data that fit the particular printer buffer being addressed) and returns it to the BIP. The BIP adds the transmission blocks to the TIP's queue and, if necessary, notifies the TIP that data is ready for the printer.

As the TIP sends blocks to the printer, the BIP monitors the queue. When necessary, the BIP notifies the host. The host can send another PRUB if one is available.

When Mode 4A printing has completed and the accounting message has been generated, the TIP returns to polling of the console for input if the card reader is not active. Otherwise, the terminal remains in batch mode.

## Skipping Printer Data

Interrupt commands from the host can cause the TIP to skip a specified portion of the printer data. The point in the data stream where the skip is to end is marked. After receiving the interrupt, the TIP continues to receive data, but discards all of it until the end skip marker is received. Then the TIP sends accounting data to the host.

## Printer Busy

Busy status permits the operator to stop printing, to inspect the printed output, and to resume printing without console input.

If a printer is ready but busy, the TIP holds data and periodically checks status. When the printer is again ready, the TIP resumes printing. The host is not notified.

Since some Mode 4A printers do not always report printer not ready status, a different method is used. To interrupt printing or to generate a ready status, the operator presses the interrupt key. This toggles the printer between ready and busy status.

Mode 4C printer status is determined by the terminal status request. Printer not ready condition is not reported to the host; printing automatically resumes when the printer becomes ready.

In no case does the remote terminal operator receive a console message indicating that the printer is not ready. The printer should normally be left in the ready state to avoid unnecessary recovery processing.

## Page Eject

Two types of Mode 4C printers are supported: impact and nonimpact.

The impact printer supports page eject and is controlled by vertical carriage control characters.

The nonimpact printer does not support page eject, so the TIP formats a virtual page image. The number of lines on the page is specified when the device is configured. Sixty lines is the default page length; six lines separate pages. Therefore, the TIP varies the number of line feeds it generates to support page eject.

## Print Message

If a print message is received (TIP detects PM at the beginning of a print line), the TIP builds a separate PM message and sends it to the BIP, which in turn sends it to the host. This allows the host to send messages to the console before continuing the printed output. When the host sends an interrupt resume command, the TIP restarts printing with the print line following the PM line.

## Mode 4 Error Handling

When the TIP detects a failure that cannot be corrected by a set number of retry attempts, the terminal is reported as failed and long-term error recovery begins. For Mode 4A terminals, failure of one device causes failure of all devices on the cluster.

Recovery attempts occur every 10 seconds during long-term error recovery.

## BINARY SYNCHRONOUS COMMUNICATIONS (BSC) TIP

The BSC TIP provides data interchange between a host application program and a remote IBM 2780, 3780 or compatible batch terminal. In addition to the terminal's batch capabilities, BSC terminals simulate an interactive console device by sending interactive input from the card reader and receiving interactive output on the line printer.

Exchange of information between the NPU and a terminal uses the point-to-point binary synchronous communications protocol with contention resolution (not all features of that protocol are supported). The NPU converts BSC batch data to/from PRUB format, and BSC interactive data to/from IVT blocks. The normal code of a 2780/3780 is EBCDIC. Provision is made for transmitting to or receiving from these terminals in transparent mode.

2780 and 3780 have unique subTIP types. For the purposes of the application interface, the 2780 and the 3780 terminals have exactly the same attributes as HASP terminals.

BSC terminals can be attached to an NPU through dedicated or dial-up lines. The TIP is insensitive to line speeds; it supports synchronous lines operating at speeds up to 19200 bps. All lines are treated as half-duplex, that is, the TIP is either transmitting or receiving but not both simultaneously. Each BSC line is connected to one 2780 or 3780 terminal. A terminal consists of:

- A required card reader which sends interactive as well as batch input data
- A required line printer which receives interactive as well as batch output data
- An optional card punch

## Terminal Device Selection

The following rules apply to terminal device selection:

- Input has precedence over output
- Interactive data has precedence over batch data

Batch card reader input is allowed if the simulated console input is not active. Batch output can be interrupted to accept card reader input; the interrupted output is resumed when input ends. Card reader input (either batch or interactive) is not interruptable.

A new batch output can be started if no input is active and no simulated console data is queued. If the terminal user interrupts to send card reader input, the batch output is suspended. Batch output restarts when an upline end of transmission (EOT) is received, and continues until the end of job (EOJ) before any new batch output can be started. There is one exception: a print message (PM). Print messages are explained in the Mode 4 TIP description.

#### Batch Input Characteristics of 2780 and 3780 Terminals

Terminals normally operate in non-transparent mode. If the feature is supported by the terminal, a terminal can operate in transparent mode. Five types of batch input are supported:

- 2780 non-transparent
- 2780 transparent
- 3780 non-transparent
- 3780 transparent
- 2780/3780 transparent

The BSC TIP checks for data mode information (026, 029) in columns 79/80 of job deck and EOR cards.

If the host becomes unavailable or the NPU reaches buffer saturation, the TIP stops or delays input until the reason for input regulation is removed. If input is already active, the TIP can delay input by sending a wait/acknowledgment (WACK). If the regulation occurs before the first input data arrives, the TIP stops input by sending an EOT.

The 2780 non-transparent characteristics are:

- First card is assumed to be a job card
- Job is terminated by (1) /\*EOI, in columns 1-5, or (2) an ETX in column 80 of the last card or in column 1 of the next card, or (3) last card is sent with the EOF toggle switch on.
- Trailing blanks are transmitted except after EM or ETX
- Blank compression is accepted
- Up to seven records per transmission block
- Multiple batch jobs can be stacked in the reader. Each job terminates with a /\*EOI. Blank cards, /\*EOR cards and extra /\*EOI cards after a /\*EOI are discarded.

The 2780 transparent characteristics are the same as the 2780 non-transparent characteristics except:

- Transparent switch is on
- A full 80 characters are transferred for each card (one record)
- One record per transmission block.

The 3780 non-transparent characteristics are the same as the 2780 non-transparent characteristics except:

- Job cannot be terminated by an ETX in column 80 of last card.
- For multiple jobs, the last job must be input with the EOF toggle switch on.
- Trailing blanks are truncated
- Data can be compressed
- Transmission block is limited by character count (usually 512) rather than record count

The 3780 transparent characteristics are the same as the 3780 non-transparent characteristics except:

- Transparent switch is on
- 80 characters transmitted per card (no truncation or compression)

The TIP provides another batch input transparent mode for both 2780 and 3780 terminals. This mode of input can be specified only when a terminal is operating in the 2780 or 3780 transparent mode. Characteristics of this transparent mode are:

- Mode activates when TIP detects TR in columns 79/80 of an EOR card
- Neither EOR or EOI cards are recognized
- Input file is terminated by setting the EOF toggle switch on
- Terminal transparent switch must remain on until the file is ended
- The TIP returns to the non-transparent mode for the next batch job.
- Data is stored in a PRUB without marking record boundaries (such as 80 column card boundary) or transmission block boundaries
- Transmission block can be split between PRUBS

#### Batch Output Characteristics of 2780 and 3780 Terminals

Four types of batch output are supported:

- 2780 non-transparent
- 2780 transparent
- 3780 non-transparent
- 3780 transparent

The BSC TIP bids for the line whenever the host sends downline data and the line is available. Once downline data transfer starts, it continues until an EOJ PRUB is sent from the host or a print message (PM) is detected on the print stream.

For non-transparent output, the TIP supplies appropriate carriage control transformations (format effector processing). The host can supply preprint or postprint format effectors; BSC terminals support only postprint carriage controls. The BSC format effector transforms are given in the CCP System Programmer's Reference Manual.

Card punch and printer connections appear the same to the TIP except for punching a lace card and changing data mode. Punching a lace card and changing data mode are activated by a batch device file command from the host. Three card punch modes are available: 026, 029 and transparent. PRUBs containing EOR or EOI cause a 7/8/9 card with level numbers or /\*EOI card to be punched. Print message and carriage control are not supported on card punch connections.

The 2780 non-transparent output characteristics are:

- Streams directed to line printer or card punch (provided punch option is present)
- Host determines device to receive output (separate connections for each device)
- TIP converts PRUB data to EBCDIC 64/96 character set
- TIP formats print lines into BSC transmission blocks
- 1 to 7 print lines (records) per transmission block
- Maximum transmission block size (default is 400 characters)
- Print line is never split across transmission block boundaries
- Short line is terminated by unit separator (US)
- Transmission block is terminated at the last data character of a PRUB block that is marked as an EOR, EOI, or EOJ block
- Blank compression if terminal supports that feature

The 2780 transparent output characteristics are:

- Transparent output only if output is specified as transparent (designated transparent by a preceding command)
- No code conversion or carriage control transforms
- PRUB characters packed into transmission block until maximum size or EOR/EOI packed (no record markers)
- Characters in transmission block formatted into records; record size defined by page width (if page width field is zero, record size limited only by transmission block size)
- EOR PRUB terminates only the transmission block; next transmission continues with next PRUB block and a new transmission block
- EOI PRUB terminates the file
- No EOR or EOI cards punched on card punch connection.

The 3780 non-transparent output characteristics are the same as the 2780 characteristics except:

- Number of print line records or card records limited only by the transmission block size (normally 512 characters). Short records (print lines or cards) terminated by the EBCDIC IRS character
- Trailing blanks in the PRUB record are truncated

The 3780 transparent output characteristics are identical to the 2780 transparent output characteristics.

#### Print Message (PM)

The characters PM at the beginning of a print line activate the print message logic. If the TIP detects a PM, the print line prior to the PM is sent to the line printer. Output is then stopped and the host is notified with a message of 80 or fewer characters. This enables the host to send an interactive output message to the printer. Batch output to the printer does not resume until ICMD, resume, or terminate output command is received.

#### Interactive Input and Output Mode

The interactive virtual terminal input mode characteristics are:

- All interactive cards begin with /\*; the TIP strips this interactive card indicator
- IVT commands from the terminal have the special control character CT=% in the third character position
- Input is sent to the host as a MSG block
- Interactive input is on a separate card stream from batch input (inputs must be separated by EOT)
- No transparent data mode

The interactive virtual terminal output mode characteristics are:

- Message output preceded by triple space to position the message for reading
- Message output followed by double space to position the message for reading
- Interactive output is single spaced
- Message output occurs at input and output file boundaries or when the printer is stopped for PM message; all interactive output messages in queue are delivered before any more batch output
- No transparent data mode

## Autorecognition

Autorecognition allows the terminal to report its own type, cluster address, and terminal address (the latter is used for the optional card punch). A /\*CONFIG card must be the first card received from a terminal after an autorecognition line is enabled. Information from this card is extracted by the TIP and passed to the host. If the TIP detects a card error, it sends an error message to the printer. Then the TIP waits for retransmission of the correct card. The /\*CONFIG card format is:

```
/*CONFIG, terminal, CO=M, CR=1, LP=1, CP=N
```

where:

terminal = subTIP (2780 or 3780; default is 2780)

M = Cluster Address (range 1-255; default = 0)

N = Card punch (1 = none, 2 or 3 = terminal address of punch; default = 1)

Any input immediately following a configuration card is discarded; input is allowed only after the input connection is established and started.

## IVT Commands

The TIP supports these IVT commands:

- MS, Operator message
- CT, Change control character

An error message is returned to any terminal which sends an illegal IVT command.

## Downline File/Device Commands

The TIP supports the following output file types:

LP - Display code, ASCII - 96  
CP - 026, 029

## HASP MULTILEAVING TIP

The TIP provides network interfacing to a HASP multileaving workstation. A workstation can contain both interactive and batch devices and has computer-like functions. The term multileaving describes the computer-to-computer communications technique used by a HASP terminal. The system uses fully synchronized, pseudo-simultaneous bidirectional transmission of several data streams between computers and requires BSC protocol as a basis for transmitting HASP blocks.

A HASP terminal consists of a required console, one to seven card readers, one to seven printers, and one to seven card punches or plotters (in combination). Each device has a separate data stream identification.

## Summary of HASP Protocol

The basic element of multileaved transmission is a character string which is embedded in a data (message) block. One or more character strings are formed from the smallest external element of transmission - the physical record. The physical records, which serve as input data, may be of any normal record types (card images, printed lines, mass storage records, etc.). For efficiency in transmission, each record is reduced to a series of character strings of two basic types: a variable-length nonidentical series of characters or a variable number of identical characters. Since blanks appear frequently, a special case of the identical character string is the string of blanks. A string control byte (SCB) precedes each character string to identify the type and length of the string. A nonduplicate character string is represented by an SCB followed by the nonduplicate characters. A consecutive, duplicate, nonblank character string is represented by an SCB (which contains the character count) and a single character. For an all-blank character string, only the SCB itself is required.

The transmitting program segments the data record to be transmitted into an optimum number of character strings, a number determined to take full advantage of the identical character compression. A special SCB indicates the grouping of character strings which compose the original physical record. The receiving program then reconstructs the original record for processing.

In order to allow multiple physical records of various types to be grouped together in a single transmission block, a record control byte (RCB) precedes the group of character strings representing the original physical record. The RCB identifies the general type and function of the physical record (input stream, print stream, Data Set, etc.). A particular RCB type is designated to allow the passage of control information between the various systems. To provide for simultaneous transmission of similar functions (multiple input streams), a stream identification code is included in the RCB. A subrecord control byte (SRCB) is also included immediately following the RCB. The SRCB supplies additional information concerning the record to the receiving program. (For example, if the transmitted data is to be printed, the SRCB can hold carriage control information.)

For a multileaving transmission, a variable number of records may be combined into a variable block size; e.g., RCB,SRCB,SCB1,SCB2,...SCBn,RCB,SRCB,SCB1,... Multileaving allows two computers to exchange transmission blocks containing multiple data streams in an interleaved fashion. For optimum use of this capability, a system must be able to control the flow of one data stream while continuing normal transmission of others. This requirement is obvious in the case of simultaneous transmission of two data streams to a system for immediate transcription to physical I/O devices with differing speeds, such as two print streams. To meter the flow of individual data streams, a function control sequence (FCS) is added to each block. The FCS is a sequence of bits, each one representing a particular transmission stream. The receiver of several data streams can temporarily stop the transmission of a particular stream by setting the corresponding FCS bit OFF in the next transmission to the sender of that stream. The stream can subsequently be resumed by setting the bit ON. In this release multileaving is used only by the HASP terminal. The host does not regulate device data; rather the host's output is regulated by the devices' use of FCS bits.

For error detection and correction purposes, a block control byte (BCB) is added as the first character of each block transmitted. The BCB contains control information and a block sequence count. This count is maintained and verified both by the sending and by the receiving systems to control lost or duplicated transmission blocks.

In addition to the normal binary synchronous text control characters (STX, ETB, etc.), multileaving uses two acknowledgment signals, ACK0 and NAK. ACK0 is the normal block received acknowledgment and it is also utilized as a filler by all systems to maintain communications when data is not available for transmission. NAK is used as the negative response; it indicates that the previous transmission was not successfully received.

Information blocks are of two types:

- control blocks which contain control information and the SCB
- data blocks which contain data and the other control bytes described above

### Protocol Operation

The terminal software is loaded and the communications line is initialized. After the sign-on command is transmitted, the NPU and the terminal transmit idle blocks until a function is desired.

When a function other than a console message or console command is desired, the process initiating the function transmits a request to initiate function transmission RCB.

The receiving process transmits a permission to initiate function transmission RCB if the data from the requesting process can be processed. If the data cannot be processed, or the function is now in process, the request to initiate a function transmission RCB is ignored.

When permission to initiate a function transmission RCB is received, the requesting process begins transmitting data blocks to the other process. Data blocks are transmitted until an EOF is encountered. If more data blocks on the same device stream are to be transmitted following an end of file (EOF), the request to initiate function transmission RCB sequence must be reinitiated. If a request to initiate a function transmission is not received before data blocks are received, the data blocks are ignored.

Data blocks are transmitted one at a time. Before another block can be transmitted, the receiving process must transmit a positive response in the form of an acknowledge control block or a data block.

Console functions (operator messages/commands) do not have to follow the request to initiate-permission to initiate sequence. A console function may be initialized at any time when the wait flag in the FCS is not set and the remote console flag is set.

### Control Blocks

Four types of control blocks are used in the multileaving protocol. These control blocks are:

- acknowledge blocks which contain synchronous control, data link escape control, and positive acknowledgment information

- negative acknowledge blocks which contain synchronous control and negative acknowledgment information
- enquiry blocks which contain synchronous control, start of header and enquiring control information
- idle blocks which maintain communications; an idle block is transmitted at least once every two seconds in the absence of data transmissions

### Data Blocks

In addition to the control bytes described earlier, data blocks contain synchronous, escape, start of header or text, end of block transmission, and cyclic redundancy check (CRC) information.

Special short blocks are defined for:

- operator console blocks which deliver console messages in addition to other control information
- EOF blocks (sign-off indication)
- FCS mode change blocks (for instance, a low-speed printer has all the information it can currently handle as input)
- sign-on blocks
- BCB error blocks

### Error Handling

Errors are recognized for:

- CRC errors
- illegal block format
- unknown responses
- timeout over the line
- BCB-recognized errors (break in sequence of transmitted blocks)

For bad downline data, the TIP attempts to retransmit the block three times. On the fourth failure, the TIP forces a line inoperative status on the terminal. For upline data, the TIP will attempt to receive a bad block four times. On the fourth failure, the TIP forces a line-inoperative status on the terminal.

### Data Conversion

HASP terminals use EBCDIC code; host programs use ASCII code in IVT blocks and display or ASCII code in PRUBs (transparent data is permitted for both batch and interactive devices). Upline, the TIP performs code conversions at the same time that the data is transformed to IVT or PRUB format. Downline, the TIP converts data to EBCDIC when the HASP transmission blocks are generated. Note that there is no code conversion and minimum formatting conversion if the message data is transparent.



## HASP Console Conversions

Downline, the TIP accepts IVT messages from the host and delivers them to the console. Upline messages received from the console are converted to ASCII IVT format and sent to the host.

## HASP IVT Commands

An operator at a HASP console can change the following IVT parameters for his terminal:

- Page width
- The characters used for cancel, IVT control, and user breaks one and two

The operator can also send a message to the NOP console.

## HASP Input Batch Data

The card reader is the only HASP batch input device. The reader is activated by a start input command. A card reader stream remains active unless terminated by:

- An EOF block from the reader
- An abort input command from the host
- A terminal reconfiguration command from the host
- A workstation or line failure

All data following an abort is discarded until a start input command is received from the host.

A /\*EOI card or EOF block indicates normal termination of a job; the TIP/BIP terminates the PRUB and sends the (short) PRUB to the host. The TIP discards any /\*EOI cards following an end of file.

The HASP workstation does not report a card reader not ready condition.

Card reader data is transformed to PRUB format in either transparent or non-transparent mode. Transparent mode is selected by one of two methods:

- TR in columns 79/80 of an EOR card
- A start transparent input command from the host

If a TR is detected in the input stream, the host is notified. In this transparent mode neither /\*EOR (7/8/9 punch) nor /\*EOI cards are recognized. The file is read until an EOF block is received.

The HASP TIP examines columns 79/80 of all job and EOR cards to determine if the code translation should be the 026 or 029 character set (26 specifies 026 set; 29 specifies 029 set). Code translation reverts to the terminal's default code (a terminal configuration parameter) after a /\*EOI card or EOF block is detected.

EOR cards are examined for level numbers. The level number is stored in the PRUB.

## Card Reader Non-Transparent Mode

In non-transparent data mode, card reader characters are expanded from HASP compressed format, translated to display code, and stored in PRUB blocks. The TIP indicates an end of card in standard host format (insertion of blank fill to an even character boundary, then filling with two or more zeros to reach card character count divisible by 10).

If the last data character is a colon in the 64 character set, one or two spaces are inserted (depending on character boundary). In 64-character set, contiguous colons on input cards should be avoided since two binary zeros signal the end of card.

## Card Reader Transparent Mode

Transparent 8-bit characters are expanded from the HASP compressed format and are stored in the PRUB without translation or marking card boundaries. Records or transmission blocks are stored contiguously within the PRUB and can be split across PRUB boundaries. Data is stored until an EOF block is received. The PRUB receiving the EOF is marked as the end of input.

The card reader stream remains in the transparent data mode. The TIP waits for a start input command to determine the next input data mode.

## Card Reader Accounting Data

Accounting data consists of the number of input cards received by the TIP. In non-transparent mode, standard text cards are counted; in transparent mode, the number of characters received is divided by 80 to calculate the number of cards.

Accounting data is sent to the host when an EOI is recognized or when the host aborts the input data stream.

## HASP Printer Output Data

Output to the printer is activated by the host sending a downline data block (PRUB) to a printer. Subsequent PRUBs are converted to output transmission blocks according to the BSC point-to-point and the HASP multileaving protocols.

The terminal mode (transparent or non-transparent) has been previously determined and saved in the TCB. Data is converted accordingly.

The TIP checks file limits. If a file limit is reached, the host is notified. The BIP does not send more transmission blocks to the TIP unless the host restarts the data stream. The host also has the option of terminating the stream. Note that file limits can be changed by a batch file command from the host.

## HASP Printer Non-Transparent Mode

Non-transparent output data is deemed to have the form of print lines. The end of each line is marked by an FF<sub>16</sub>. If the print line from the PRUB exceeds printer line width, the excess characters are printed on the next line. Print lines are never split across transmission blocks. The first character of each line is normally interpreted as a carriage control character.

Output of files is continuous as long as the printer is available and ready or the last block of a file is transmitted and acknowledged. When the terminal acknowledges the last block of a file, accounting data is sent to the host. The host interprets this accounting data as delivery assurance.

If the HASP TIP detects PM at the beginning of a print line, the TIP terminates the current transmission block and generates a print message for the host. No more batch data is sent to the terminal until the host sends the print message to the HASP console. The host then restarts the print stream.

## HASP Printer Transparent Mode

Print lines are not detected within the PRUB. Characters are placed in the transmission block without code conversion, carriage control, or end of line processing. However, characters are compressed whenever possible. Transparent transmission blocks are filled to the device width, except for the final data record, which may be short.

## Printer Accounting Data

Accounting data for a printer consists of the number of output lines sent to the device. An output line is based on device width (the host can change device width with a PRU command). Accounting data is sent to the host after the EOI block is transmitted and acknowledged or when the host interrupts and terminates the output stream. In the termination case, all further output data is discarded until the TIP receives the terminate marker (see the skipped data description in the BSC TIP).

## HASP Postprint Carriage Control

Files for the HASP printer can have either preprint or postprint carriage control format effectors. The HASP TIP converts the pre/post print format effectors to pre/post print SRCBs, depending on whether the printer has been configured as preprint or postprint. Note that some HASP printers cannot suppress carriage control. These printers will sometimes generate extra spaces on output and will not overprint.

## HASP Card Punch Output Data

Card Punch output is processed in a manner similar to print output except:

- There is no carriage control
- Output records have a maximum of 80 characters
- In some cases, a lace card (80 columns of punches in rows 8, 9, 11, and 12) is punched.

Transparent data can be sent to the punch. Transparent mode is specified in the same manner as for the printer. Files are handled as for transparent line printer files except a lace card is punched in place of a printer banner page.

Accounting data handling and file limit checking are handled in the same manner as for printer files. The device width for the punch is 80 characters.

## HASP Plotter Output Data

Plotter output is processed in a manner similar to transparent printer output. Accounting data handling and file limit checking are similar to that described for printer files.

## HASP Error Recovery Procedures

A NAK block informs the receiving process of a transmission error.

For output errors, the TIP saves the last downline data block so that it can retransmit the data if necessary. If retransmission continues to fail after several successive attempts, the TIP forces the line into inoperative status.

The workstation has similar retransmission ability for failed upline transmissions. If the TIP receives the same block incorrectly on several successive attempts, the TIP marks the line as inoperative.

## HASP Terminal Start-Up and Termination

Terminal start-up is accomplished by a three-step process:

- Terminal initialization
- Communication line initialization
- Sign-on

### Terminal Initialization

Terminal software is loaded into the workstation and executed. For an autorecognition line, the workstation sends a signon record (a /\*CONFIG or /\*SIGNON card). The signon record format is described in the CCP System Programmer's Reference Manual.

### Communications Line Initialization

The configure line service message from the host starts line initialization. Communications between the HASP TIP and the terminal are established by the following procedure:

- The terminal sends an ENQ
- The TIP returns an ACK
- The terminal sends a sign-on record. If the TIP detects an error in the card, it sends a message to the HASP console detailing the error. Then the TIP waits for resubmission of the card. The TIP acknowledges a good signon record with an ACK. The terminal is then ready to do normal processing.
- The HASP TIP passes configuration parameters to other NPU modules. Then it waits for the batch devices to be configured. After each device is configured, the HASP TIP allows output data streams processing. Input data streams processing does not begin until start input commands are received from the host.

### Signoff Record

A /\*SIGNOFF card from the terminal has the same effect as an EOF block if the card reader is active; otherwise, it is ignored.

## X.25 TIP/PAD SUBTIP

A public data network (PDN) uses the CCITT X.25 protocol to transfer data over a high-speed link.

The packet assembly/disassembly (PAD) access of the PDN uses CCITT X.3 protocol to process data from TTY-type terminals connected to the PDN. Processing consists of collecting individual characters into packets (upline) or extracting individual characters from packets to send over the voice-grade terminal lines (downline). Parameter variations for PAD access transforms are governed by the CCITT X.28 and X.29 protocols.

Level 2 of the X.25 TIP provides the NPU's interface to the PDN for transferring information (level 2 is assisted by the NPU's multiplex subsystem).

Level 3 of the X.25 TIP provides the NPU's interface to the PDN for multiplexing several logical channels through a single, physical level 2 interconnection.

Table 2-7 summarizes the data transfer characteristics between terminals and the public data network devices and the X.25 TIP in the NPU.

The normal mode for the subTIP is conversion to/from IVT format. However, transparent mode is supported on both input and output.

#### X.25 Input Sequence

Messages originate in a TTY-type terminal as an ASCII character string preceded by a header and followed by a trailer. A message is transmitted asynchronously, one character at a time in bit-serial format, over a voice-grade line. The PDN's PAD access collects the characters in line-related (virtual channel) packets. When a packet is filled or the end-of-message signal is encountered, the packet is released for transmission through the PDN.

The PDN frames the data for transmission to the NPU. A single frame has data for only one virtual channel. After a frame is given some control information and a redundancy-check field, the frame is dispatched to the NPU over a high-speed, synchronous line. Transmission over the link is in bit-serial format.

The receiving NPU's level 2 module reassembles the incoming data into bit-parallel format, checks the frames for transmission accuracy, discards the frame fields, and directs the data to the level 3 module.

The level 3 module controls the packet level protocol; it discards the packet control fields and sends the data to the subTIP. At this time the data is associated with a specific virtual channel.

The subTIP reformats the data into blocks (the terminal's header and trailer are discarded to meet IVT requirements). Then the terminal-related blocks are passed to the block interface package (BIP) for final formatting as IVT blocks. IVT blocks are transmitted to the host through the HIP.

#### X.25 Output Sequence

On output, the subTIP receives IVT blocks from the BIP. The subTIP performs the format conversion necessary to place the data in ASCII terminal format. This includes generation of the terminal's header and trailer, as well as the format changes which supply the proper line length and number of lines per page. A page-wait capability is supplied for terminals with displays. The subTIP repacks the ASCII characters into data blocks. Data blocks are sent to the packet level (3) of the TIP.

The packet level module maintains queues of packets. When the frame level TIP needs more information blocks, it requests them of the packet level. The packet level responds by sending a set of information blocks from a single packet queue.

The frame level (2) places the information blocks into frames. Appropriate control and redundancy checking logic is attached to the frame so that the PDN can check the data for accuracy. Frames are sent continuously to the PDN on the high-speed synchronous line. Copies of frames

TABLE 2-7. X.25/PAD TIP AND PDN TRANSFER CHARACTERISTICS

<p><b>TERMINAL</b></p> <ul style="list-style-type: none"> <li>. Asynchronous lines</li> <li>. ASCII code set</li> <li>. Dial-in or dedicated lines</li> <li>. Single character transfers to/from PAD access in bit-serial format</li> <li>. Logical line sized message</li> </ul>
<p><b>PAD ACCESS IN PDN</b></p> <ul style="list-style-type: none"> <li>. Packet disassembly downline</li> <li>. Downline routing to individual terminals as a bit-serial character stream</li> <li>. Packet assembly upline</li> </ul>
<p><b>PUBLIC DATA NETWORK</b></p> <ul style="list-style-type: none"> <li>. Network routing</li> <li>. Interface to level 2 and level 3 of the NPU's X.25 TIP</li> </ul>
<p><b>X.25 TIP FRAME LEVEL</b></p> <ul style="list-style-type: none"> <li>. Link synchronization and maintenance</li> <li>. Frame formation downline (information from level 3 placed in frames; all information in a frame from one virtual channel)</li> <li>. Downline frame retransmission as necessary</li> <li>. Frame checking upline</li> <li>. Discards frame fields upline (passes information to level 3 TIP)</li> </ul>
<p><b>X.25 TIP PACKET LEVEL</b></p> <ul style="list-style-type: none"> <li>. Packet queues maintained downline (one queue for each virtual channel)</li> <li>. Passes groups of packets as information queues to frame level on request (a group consists of packets selected on a strict rotational basis from a single queue)</li> <li>. Packet queues maintained upline (one queue for each virtual channel)</li> <li>. Requests retransmission of missing packets upline</li> <li>. Supplies data to subTIP upline (the data consists of one or more packets with the packet header removed)</li> </ul>
<p><b>PAD SUBTIP</b></p> <ul style="list-style-type: none"> <li>. IVT block formation upline (conversion to host format)</li> <li>. IVT blocks passed to BIP for transmission to host</li> <li>. Conversion from IVT block format downline to terminal format</li> <li>. Terminal formatted data placed in downline data blocks</li> <li>. Blocks passed to packet level downline (downline data blocks passed to level 3 are sized to fit packet rules)</li> </ul>

are retained so that if errors occur during transmission, frames can be retransmitted. Acknowledged frames are discarded.

The PDN checks frame accuracy and requests retransmission if necessary. The PDN routes the data to the appropriate PAD access, which disassembles the data and sends the messages to the destination terminals one ASCII character at a time.

#### Supported Terminal Classes

The X.25/PAD subTIP supports the following terminal classes shown in table 2-8. Only the ASCII mode of these terminals is supported.

TABLE 2-8. X.25/PAD SUBTIP TERMINAL CLASSES

Class	Identifier	Characteristics
1	Teletype M33, M35, M37, M38	Typewriter input, hard copy print output
2	CDC 713-10	Keyboard input; scrolling display output
5	Teletype M40	Keyboard input; scrolling display output
6	Hazeltine 2000	Keyboard input; scrolling display output
7	CDC LIAT 751, 752, 756	Keyboard input; scrolling display output
8	Tektronix 4014	Keyboard input; scrolling display output

#### Transparent Mode

The X.25 TIP allows transparent input and output. Transparent input mode can be commanded either from the terminal or from the host; transparent output mode is selected by the application program. In either direction, transparent mode terminates at the end of the message.

All data following the start of transparent mode are considered to be transparent characters; however, the subTIP scans all characters to detect the transparent delimiter (this is often chosen to be a carriage return). Upon detecting the transparent delimiter, the subTIP returns to normal mode.

During output, the TIP waits for a page-turn signal at the end of the transparent message if page-wait mode is selected.

#### Autoinput

If the downline message specifies autoinput, the subTIP saves the first 20 characters of the output. When the requested input arrives, the subTIP appends the input to the saved data up to the length of one logical line, and transmits the composite message to the host.

#### Parity

On input, character parity is carried in the ASCII character as far as the subTIP. The subTIP ignores parity, but it strips the parity bit from the character before releasing the block to the host. Parity is not stripped from transparent input if the parity selection is none (PA=N).

On output, parity actions are taken as shown in table 2-9.

TABLE 2-9. PARITY ACTIONS

Parity Type	Mode	TIP Action
odd	transparent	supplies correct parity
odd	normal	supplies correct parity
even	transparent	supplies correct parity
even	normal	supplies correct parity
zero	transparent	sets parity to zero
zero	normal	sets parity to zero
none	transparent	sends any existing parity
none	normal	sets parity to zero

#### Typeahead Input from the Terminal

The CCITT X.3 standard does not specify typeahead; therefore the X.25 TIP cannot guarantee typeahead. Some PDNs may provide support typeahead as an option. The X.25 TIP does not exclude the use of typeahead.

#### Block Mode

Supporting block-mode terminals is largely determined by the PAD access. This includes definition of the block-forwarding signal and the input device's flow control logic.

Fragmentation caused by packet assembly and the PAD subTIP's physical line processing makes reconstruction of a single block-mode transmission from a terminal difficult. Since physical line boundaries are generally eliminated, data may be lost if the message-forwarding signal is not consistent throughout the CDC and packet switching networks.

#### Backspacing from the Terminal

After the backspace character itself is discarded, it causes the TIP to discard the previous character unless that character was a part of the previous physical line. In that case, the backspace character is ignored. Note that some data characters are control codes without a graphic representation, and other data characters move the cursor on the display. For this reason, a physical line boundary may not be obvious from the terminal.

## Cancel Input

An input line can be cancelled by the terminal operator entering the cancel character followed by the forwarding character. The input line is discarded and a \*DEL\* message is returned to the terminal. If part of the line has already been sent to the host, a cancel message is sent to the host.

## Break Key Processing

Break processing occurs in the PAD access and in the PAD subTIP if the CCITT X.3 break option is chosen.

On the PAD access level, all data queued for the terminal and all subsequent data received from the PSN is discarded. The PAD access notifies the subTIP.

The subTIP suspends output until the next input is received from the terminal. The PAD subTIP notifies the PAD access to allow subsequent output messages.

At the PAD subTIP, processing differs according to whether the input following the break key is a user break or not:

- Not a user break: output to the terminal resumes after input. Data discarded by the PAD access is lost. Recovery of data is the responsibility of higher level processes.
- User breaks: subTIP discards data and notifies the host.

## USER BREAKS

A user break can occur during any input message; it need not follow an indication of a break key from the PAD access.

## Formatting on Output

For a given output message, formatting occurs on either a preprint or a postprint basis, but never both.

Some formatting can occur as a result of the subTIP converting format effectors to the appropriate number of carriage returns, line feeds, escape characters, and the like.

For displays, the subTIP supplies the appropriate line length, the number of lines on a display, and a pause at the end of a display page. The terminal operator must answer the pause by requesting a page turn. When this occurs, the TIP sends the next full page of data.

For printers, the subTIP supplies the appropriate line length, the number of lines on a page, and the proper formatting to advance the form-feed mechanism to the top of the next page.

## IVT Commands

The user can alter any of the IVT parameters shown below at the terminal. These altered values remain a part of the TIP's processing until changed from the terminal, or by a host program. When the NPU is stopped and restarted, the default IVT parameters are again used.

## Command

## Allowable Value

TC - terminal class	1, 2, 5 - 8.
PW - page width	0 - 255
PL - page length	0 - 255
PA - parity	Z (zero), O (odd), E (even), N (none)
CN - cancel	Any keyboard character
B1 - user break 1	Any keyboard character
B2 - user break 2	Any keyboard character
CT - control character	Any keyboard character
CI - CR idle count	0 - 255
LI - LF idle count	0 - 255
DL - transparent text delimiter	Xhh where hh is the character's hexadecimal value
IN - Input device	X (transparent keyboard), K (keyboard), XK (transparent keyboard)
MS - message to network console operator	Any text up to 50 characters in length
PG - page-wait mode	Y (yes), N (no)

## Build-Time Selections

At the time the user subscribes to the public data network, he purchases certain interface options. In several cases, these options effect the network definition language (NDL) selections required by the NOS network. Table 2-10 defines these parameters and gives the recommended settings for use with the NOS network.

## MESSAGE PRIORITIES AND INPUT REGULATION

Messages are defined to be high or low priority as a function of the type of terminal which handles the message. Regulation of messages is provided because all messages require buffer space, and it is possible that combined peak load demands from terminals, from the host, and from neighboring NPUs (if any) may require more buffers than the NPU can assign.

To prevent NPU stoppage for lack of buffers, the NPU is allowed to reject input messages on the basis of priority or because the channel seeking to input the messages already has its maximum share of buffers assigned. For terminals which are polled for input, regulation is handled indirectly: the NPU does not poll the terminals until more buffers are available. As current messages are processed and output, more buffers become available and the regulation level can change to accept message types previously rejected. Two types of regulation are provided:

- Input message regulations: Varying criteria apply according to the message source: host, neighboring NPU, or terminal.
- Logical link regulation: Varying criteria apply according to traffic direction: upline or downline.

## MESSAGE PRIORITIES

Three levels of message priority are defined for CCP:

- Service message traffic (priority 0): This level handles much of the node-to-node command/reply/status information.

TABLE 2-10. CCITT PAD PARAMETERS AND RECOMMENDED SETTINGS

Parameter/ Values	Description	Recommended Setting	Cautions
1 0 1	Escape from data transfer (DLE) DLE is treated as data character DLE is a PAD control character	Any	Setting = 1 allows the terminal user to change other PAD parameters. However, it eliminates the DLE character as a valid input character.
2 0 1	Echo character to terminal No echo Echo	Any	
3 0 2 126	Select data forwarding signal No data forwarding signal Carriage return Any ASCII character in the range 0 - 31	2	The data forwarding signal for the PAD subTIP should be the same as the data forwarding signal for the IVT. IVT requires CR. Other settings cause unnecessary packets and lost data.
4 0 1-255	Selecting idle timer delay No timer Time in 1/20th second increments	0	Use of the PAD timer as a data forwarding signal can be supported for line or block mode terminals. Nonzero values can be used in this fashion.
5 0 1	Ancillary device control PAD does not supply X-ON or X-OFF PAD generates X-ON and X-OFF	Any	
6 0 1	PAD service signal suppression No service signals Service signals	Any	
7 0 1 2 8 21	Selecting a terminal break signal No break signals PAD sends interrupt packet to NPU PAD sends reset packet to NPU BREAK replaces DLE PAD sends interrupt packet to NPU, clears terminal's output queues, and sets parameter 8 to 1	21	The PAD subTIP uses the BREAK key to interrupt output. The PAD sends a break-indication PAD message to stop output. Any other setting of this parameter does not stop output, but does not cause any other problems.
8 0 1	Discard output Don't discard Discard	0	Parameter is set to 1 by pressing BREAK key if parameter 7 is 21. PAD subTIP resets to 0 when it detects the break condition.
9 0 1-255	Padding characters after a CR None Number of padding characters used	0	PAD subTIP supplies number of padding characters according to the terminal class (see appendix C, CCP System Programmer's Reference Manual). Selection of this parameter is unnecessary but not detrimental. The IVT padding can also be suppressed.
10 0 1-255	Line folding after a CR None Number of characters per line	0	PAD subTIP provides line folding and screen and page formatting based on the IVT page width (PW) parameter. Additional line folding by the PAD parameter can cause double spacing and page or screen overflow.
11 0 1 2 4 6 8 10	Transmission rate (bps) of X.25 controller 110 300 1200 600 150 200 50	Any	

TABLE 2-10. CCITT PAD PARAMETERS AND RECOMMENDED SETTINGS (Contd)

Parameter/ Values	Description	Recommended Setting	Cautions
12	Controller support of PAD flow control	Any	
0	Doesn't use X-ON and X-OFF for flow control		
1	Uses X-ON and X-OFF for flow control		
NOTE			
<p>The PAD subTIP does not require that the PAD access support recommendation X.28. In general, it is not necessary for the user to change the references for normal operation of an asynchronous terminal when connected to the CDC network. Similarly, the PAD subTIP does not require supporting recommendation X.29. The PAD references are not checked for compatibility, nor are they changed as a result of any command or data. However, upon receipt of a break indication PAD message, the existence of PAD reference 7 and 8 is assumed. Further, the X.29 set PAD parameters message is assumed to reset PAD reference 8 to allow subsequent output. If PAD reference 7 is not set to 21, then support of X.29 is not required of the PAD.</p>			

- High-level (priority 1): This level is intended for messages associated with the interactive type of terminal. The size of the message is normally small but the message is quickly processed so that no processing delay is visible to the terminal user.
- Low-level (priority 2): This level is intended for messages associated with batch-type terminals. The size of the message is large (often a thousand bytes or more) but since there is no operator interaction required, a small delay in message processing is acceptable. The actual assignment of priorities by terminals is an installation time function.

**INPUT REGULATION**

Four states of regulation are available to correspond to the three message priorities. Table 2-11 indicates the type of messages which are rejected during each state of regulation.

**HOST INTERFACE REGULATION**

Regulation applies to the high-speed DMA channel of the coupler. The PPU separates its output data into three queues:

- service message queue (highest priority)
- high-priority queue
- low-priority queue

Prior to outputting data to the NPU across the coupler, the PPU sets the orderword which informs the NPU of the type and length of the next message. The NPU returns status information indicating acceptance or rejection of the message based on the NPU's current regulation state.

- NOREG: All host output messages are accepted.
- STPLOW: Messages from the low-priority queue are rejected.

- STPALL: Messages from the low- and high-priority queues are rejected.
- ALERT: No messages are accepted from the host.

**TRUNK INTERFACE REGULATION**

The input frame (see LIP description in the CCP 3 System Programmer's Reference Manual) from the sending NPU can contain low-priority, high-priority, or service message information, or combinations of priorities. Therefore, all frames are accepted until the ALERT state occurs. Then all frames are rejected. The sending NPU periodically attempts to retransmit the rejected frame. If the ALERT causes more than n rejections (n is an installation-time parameter selection), the sending NPU declares the trunk inoperative.

**TERMINAL INTERFACE REGULATION**

Prior to inviting new input from a terminal, the NPU examines its buffer state. For high-priority terminals, STPALL and ALERT stop the terminal's ability to input messages. For low-priority terminals, STPLOW, STPALL and ALERT stop the terminal (if not already stopped). Either polling stops (Mode 4 terminals), request for input is denied (HASP terminals), or input will be discarded as long as the conditions for stop exist (Async terminals). The appropriate TIP for any interactive (console-type) terminal generates an input-stopped message for the terminal. When the condition for stoppage disappears (NOREG for low, STPLOW or NOREG for high-priority), input messages are again accepted. The appropriate TIP generates an input-resumed message to all interactive terminals that received the input stopped message.

During the period of stopped input, uncontrolled interactive terminals (Async TIP) may send input to the NPU. The NPU discards this input and sends an input discarded message to the terminal. Since NPU traffic load is variable, buffer availability may improve after the NPU sends some of its output data. This may lower the

TABLE 2-11. REGULATION

Regulation Level	State	Priorities Accepted	Remarks
3	NOREG	0, 1, 2	Sufficient buffers are available for all inputs. No regulation is necessary. This regulation applies to host and terminals.
2	STPLOW	0, 1	Buffers are low. NPU rejects all low priority message blocks. This regulation applies to host and terminals.
1	STPALL	0	Buffers are critically low. Both low and high priority message blocks are rejected but service messages are accepted. This regulation applies to host and terminals.
0	ALERT	NONE	Buffers are so alarmingly low that any input message blocks could cause the NPU to run out of buffers and therefore to stop. All input blocks are rejected. This regulation applies to host, trunks, and terminals.

regulation level so that previously stopped input can be restarted. This in turn may quickly lower the buffer availability, raise the regulation level, and therefore cause the terminals to stop again. Note, however, that the buffer state is examined only prior to inviting new input from a terminal. Because of this, heavy data traffic may cause oscillation of the buffer state, causing frequent start-stop terminal input sequences, especially for low-priority data.

Since traffic, especially high-speed batch traffic, is capable of saturating an NPU faster than interactive traffic, low priority (which is regulated first), should be assigned to terminals featuring large blocks and/or high-speed capability. Interactive terminals, on the other hand, should have high priority assigned, because a high frequency of input stopped and input resumed messages could have an irritating effect on the terminal user.

**LOGICAL LINK REGULATION**

Logical link (LL) regulation controls data input from remote NPUs although it also operates in systems which have no remote NPUs. Prior to any logical connection assignment, logical links are created for any unique physical path between the host and terminal node (see figure 2-6). CS in the host distributes connection assignments between the operational logical links to level the traffic load in the network.

Since LL regulation generally affects remote data sources, there is a round-trip delay until such a regulation becomes effective. To compensate for this, LL regulation occurs prior to NPU input regulation for a given regulation level as shown in figure 2-7. The LL regulation logic is executed periodically, rather than as a function of TIP's checking input traffic prior to inviting new input traffic (see NPU input regulation, described previously).

**Upline Data**

Regulation for LLs is accomplished as a function of the origin of the problem:

- **Host interface:** The host usually does not regulate its input. The local NPU has a single output queue to the coupler. It can happen (rarely) that the host does not take that input.

- **NPU buffers:** The local NPU, which provides transient storage for the LL data, regulates upline LL data streams according to its own buffer availability.

For remote NPUs, a trunk regulation level is sent to the terminal node whenever necessary. The trunk regulation level is sent initially with the CLR-element of the trunk protocol. Subsequent trunk regulations are sent with the REGL-element.

The following trunk regulation levels are sent by the local NPU to the remote node as a function of buffer availability: NOREG, no regulation; STPLOW, stop low-priority data; STPALL, stop all data.

- **Coupler failure:** If the local NPU detects a coupler failure, it generates an ALERT-LL regulation which is sent to the terminal node.
- **Trunk failure:** If the local NPU detects a trunk failure, it sets the trunk regulation level to ALERT and the trunk becomes inoperative. This action is the same as if an ALERT LL occurred because of a coupler failure.
- **Remote NPU buffers:** The remote NPU node has its own buffers independent of those in the local NPU.

The terminal node has two regulation levels that have to be examined prior to inviting new input from a terminal:

- the terminal node's own buffer state (affects all terminals on the NPU)
- the LL regulation level (affects all terminals on that LL)

The minimum of both regulation levels is used to determine whether terminal input has to be stopped or restarted.

The ALERT level on the LL regulation indicates that a link to the host has been broken, so in this case the terminal node will generate the message HOST UNAVAILABLE to all interactive terminals on that LL. The ALERT level in the terminal node's buffer state prompts only the message INPUT STOPPED, which is probably a transient situation, whereas the message HOST UNAVAILABLE is a unique indication that either the host is down, or the link to the host has been broken.



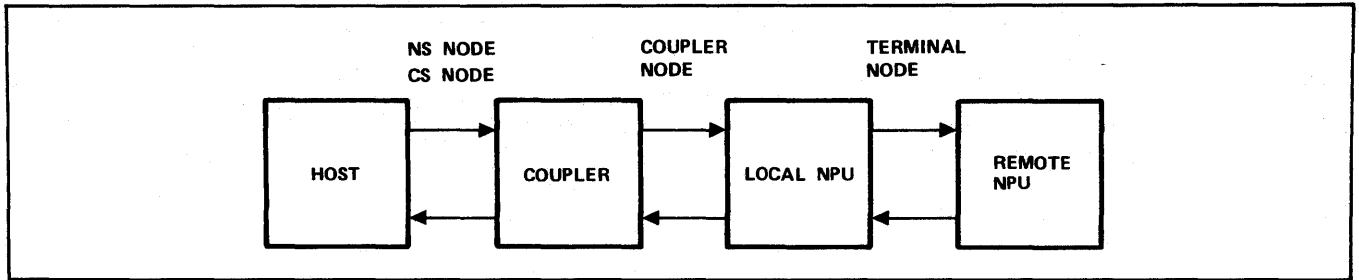

Figure 2-6. Sample Logical Link Connections (Shown for Local and Remote NPUs)

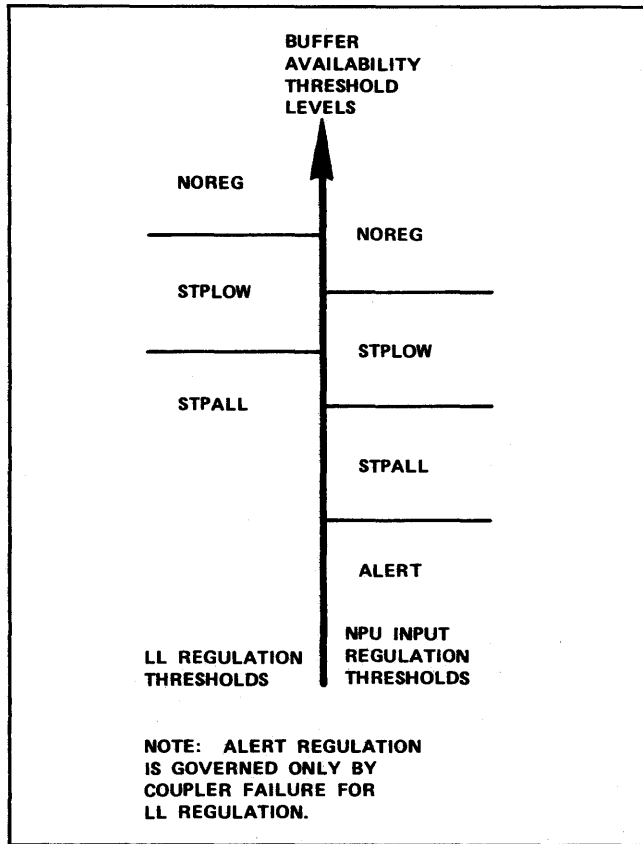

Figure 2-7. Buffer Availability Threshold Levels for Regulation

**Downline Data**

Again, regulation action depends on the origin of the problem.

- Host interface: The host monitors the received LL regulation level prior to output on that LL. If STPALL regulation is in effect on that LL, all output for that LL is stopped. If a STPLOW regulation is in effect, low-priority output is stopped by the host. All output is sent to the terminal node if a NOREG state exists.

In the ALERT case, the LL has failed and all logical connections are broken by the local NPU.

- Local NPU buffers: The local NPU which receives an REGL message over the logical link converts it to an LL-Status SM. This SM is sent to the NS in the host.
- Coupler failure: This is handled by the deadman timer in the NPU and a similar timer in the host.
- Trunk failure: When the local NPU detects a trunk failure, an LL-Status SM is sent to NS in the host. The LL-Status SM indicates the failure of the LL. The LL regulation level is set to ALERT. The host receives an ALERT-LL regulation only in case of LL failure.
- Remote NPU node: Since the remote NPU node is the receiver of downline data, it is the source of LL regulation for that data. As the host is the data source, it is informed about regulation of its output.

The remote NPU node's buffer availability determines the LL regulation level. This level is reported initially from the local NPU with the PRST-response to the CLR; it is reported subsequently by the REGL-element of the LL-protocol.

The following LL regulations are sent to the local NPU according to the terminal node's buffer availability:

- NOREG - no regulation
- STPLOW - stop low-priority data
- STPALL - stop all data

A three-step process makes each NPU into a fully operational network node. These steps are:

- Dumping the NPU to the host (This is an optional but usual procedure. A host applications program, network dump analyzer (NDA), can be executed via IAF to output the dump in a standard format for later analysis.)
- Loading the NPU from the host (A special overlay loading capability is available for on-line diagnostics if these are a part of the system. These diagnostics are not downline-loaded from the host until called.)
- Initializing the NPU by configuring the network logical links, lines and terminals that have physical connections to this NPU

The host normally attempts to load/dump an NPU only if the NPU fails or if the network operator specifically requests a load. (Note that the host itself may fail; the NPU is reloaded when the host comes back on-line.) In the case of a failure or suspected failure, the host first dumps the NPU contents. The NPU is then loaded. If the first attempt to load the NPU fails, no further dumps are taken.

Failure of a local NPU is always detected by the host PPU channel coupler driver. Upon detecting a failure condition or upon receiving a Force-Load SM (which results from the operator's load request), the NPU stops servicing the channel coupler. The PPU is then able to detect the NPU failure by a timeout of the protocol over the channel coupler.

The load/dump process varies with the type and location of the failed NPU. NPUs that are local to the host are loaded and dumped via the CYBER Coupler. NPUs are loaded and dumped using a downline procedure.

When a remote NPU fails, the deadman timer is activated. A primitive load/dump program is read into the NPU from a cassette, and that bootstrap program starts execution. The failed NPU establishes contact with a neighbor NPU, which is itself a local NPU to the host. The neighbor NPU communicates with the failed NPU using a restricted set of the communications protocol during this load/dump procedure. From this point forward, the load/dump procedure is controlled by the host.

## LOAD/DUMP PHASES FOR LOCAL NPUs

Both load and dump operations for a 2551 are multiphase and are shown in table 3-1.

### LOCAL NPU LOADING

Any NPU connected to the host is a local NPU and is loaded directly over a channel coupler by a PPU. Micromemory (RAM) is always loaded before main memory.

TABLE 3-1. LOAD/DUMP PHASES

Operation	2551
Dump	<ol style="list-style-type: none"> <li>1. Dumps main memory</li> <li>2. Loads main memory to host with small program to: <ul style="list-style-type: none"> <li>• read file 1 registers</li> <li>• checksum the RAM</li> </ul> </li> <li>3. Dumps results of program to host</li> </ol>
Load	<ol style="list-style-type: none"> <li>1. Loads RAM contents into main memory. Loads and executes programs to load RAM.</li> <li>2. Loads main memory</li> </ol>

Micromemory cannot be directly loaded by the PPU; it is loaded only by a program executing in the NPU. The PPU loads (in a manner described below) a special micromemory loading program into the NPU main memory and causes the program to be executed. The NPU then loads its own micromemory and issues an idle response to the PPU.

Main memory is written directly by the PPU to the NPU. The NPU first specifies a start location by writing memory addresses zero and one. The PPU then performs successive data transfers to the NPU, re-reading each area and comparing it word for word to ensure a correct transfer. When loading is completed, the PPU issues a start-NPU function. The NPU executes the program just loaded and responds to the PPU with an idle response. If there is no idle response, the NPU has failed.

### Load File Format

Typically, NPU operating programs and tables are formatted into a load file that is resident in the mass storage of the host. To start NPU operation, that load file (containing both the main memory-resident programs and writable micromemory-resident programs) is transferred (loaded) into the NPU.

The CCP load file contains all programs and tables except line control blocks and terminal control blocks. Since the load file defines a contiguous space in main memory, the maximum number of line control blocks that can be configured is fixed. Terminal control blocks, however, are built in dynamically acquired space and, therefore, are not similarly limited.

The format of a load file record includes a prefix made up of 15 60-bit words, a header that is a single 60-bit word, one or more blocks (each having a maximum of 120 16-bit words), and an end-of-record.

Figure 3-1 gives the typical load file format. A complete description is given in the Cross Link Loader Reference Manual.

### LOCAL NPU DUMPING, 2551 NPU

As noted previously, 2551 dumps consist of a main memory image, file register image, and a firmware checksum. The program which loads the file registers and makes the checksum is in the main memory at the time the latter two images are saved, so that program is also dumped. Coupler registers are saved by the host and are also dumped.

To transfer (dump) information from the NPU to the host, the host executes the following procedure:

1. The host reads the three coupler registers (coupler status register, NPU status register, and order-word register), and retains these values for incorporation into the register dump record.
2. The host builds the dump header record (Record 1) containing the channel and equipment number of the coupler, the date, and the time.
3. The host reads the entire NPU main memory (starting at address zero) and formats the data into blocks containing up to 120 16-bit words each, with the entire group of blocks thus constructed comprising the main memory dump record (Record 2) of the dump file.
4. The host loads a dump bootstrap program into the NPU main memory starting at address zero and causes the program to be executed. This program overwrites a portion of the micromemory with a micromemory dump routine that generates a 16-bit micromemory checksum. The dump bootstrap program then copies the 2551 File 1 registers, writes the value 8 (decimal) into the NPU status register of the coupler (to indicate ready for dump), and halts.
5. The host then again reads the NPU main memory and formats the register dump record.

Format of the 2551 dump is shown in figure 3-2. Format of the various types of words used in the dump are shown in figure 3-3.

Format of the dump as processed and output by the host NDA program is given in appendix B. A sample dump is shown in appendix B.

### REMOTE NPU LOADING

NPUs which are not coupled to the host computer (remote NPUs) are downline loaded from the host through a local NPU (neighbor NPU). The failed remote NPU and its neighbor must have a trunk between them that is operational. The sequence of events necessary to dump and then load the failed NPU are as follows:

1. The remote NPU sends a load request to its neighbor NPU (this is the request-initialization mode, RIM-element of the CDCCP protocol).
2. The LIP in the neighbor NPU sends a load-request service message (SM) to the network supervisor (NS) in the host. Format of the load-request SM is:

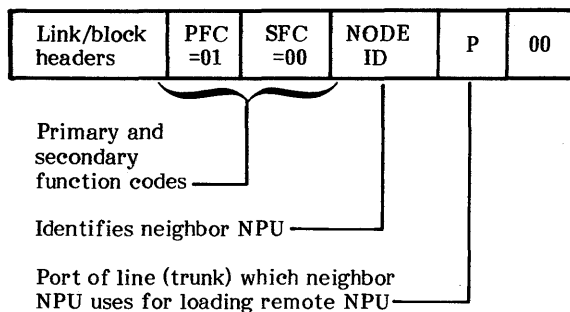

3. NS responds by loading an overlay program into the neighbor NPU's overlay area.
4. NS sends an overlay-data-clear SM to start the load/dump process. Format of the message is:

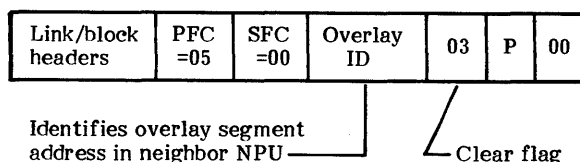

5. The dump phase is commanded by the NS. The dump is handled in the neighbor NPU by the overlay program received from the host. Blocks of remote NPU main memory are transferred until the dump is completed. This dump process is described in detail under Remote NPU Dumping. After the dump is completed, the load-remote-NPU phase starts.
6. For a load phase of the multiphase dump/load process, NS starts sending load commands to the overlay in the neighbor NPU. The load command contains an address and one or more words of object code to be loaded into the remote NPU.
7. The load commands are sent between the NPUs in batches with an acknowledgment being required from the overlay for each batch of commands successfully executed in the remote NPU. NS in the host sets the response count field of the last command of each batch to the batch value. The overlay acknowledges the batch complete when the number of commands specified has been processed.
8. NS continues to send batches of load commands from the host until the load of the remote NPU is completed. It is an NS responsibility to restrict the number of load commands outstanding to a level which avoids overloading the network by regulating traffic in the neighbor NPU while continuing the load process in the remote NPU at a reasonable rate.
9. When NS receives an acknowledgment for all load commands, the command is sent to the overlay in the neighbor NPU. The command is passed to the remote NPU. If this is the last load phase of the multiphase load/dump, the remote NPU enters its configuration procedure and attains operational status.

PREFIX IN DISPLAY CODE:

WORD	59	48	47	36	35	24	23	18	17	0
0	7700		0016		BINARY ZERO FILL					
1	DECK NAME				7777		BINARY ZERO FILL			
2	DATE									
3	TIME									
4	OPERATING SYSTEM NAME						OPERATING SYSTEM VERSION			
5	LANGUAGE PROCESSOR NAME						LANGUAGE PROCESSOR VERSION			
6	LANGUAGE PROCESSOR MOD. LEVEL					BINARY ZERO FILL				
7	BINARY ZERO FILL									
8	LANGUAGE PROCESSOR INFORMATION OR BINARY ZERO FILL									
9										
10										
11	USER COMMENTS OR BINARY ZERO FILL									
12										
13										
14										

VALUES ARE IN OCTAL NOTATION

GENERAL HEADER FOR ALL INPUT FILE RECORDS:

WORD	59	44	43	42	40	39	35	34	28	27	24	23	22	12	11	0
0	WCOUNT		N	HT	NU	PN	PR	PD	MCOUNT		NAME					
1	NAME										COMMENTS					
2	COMMENTS										COMMENTS					
7	COMMENTS										COMMENTS					

WORD	FIELD	MEANING
0	WCOUNT	NUMBER OF 16-BIT WORDS IN THE FOLLOWING MEMORY IMAGE RECORD IF HT = 1, 2, 4, OR ZERO IF HT = 0
	N	TRAILER RECORD FLAG
	HT	HEADER TYPE 0 = MEMORY RESIDENT HEADER 1 = OVERLAY AREA HEADER 2 = OVERLAY HEADER 4 = MEMORY IMAGE HEADER
	NU	NOT USED
	PN	PAGE NUMBER (NOT USED IF HT = 0)
	PR	PAGE REGISTER (FOR HT = 1, 2, 4 ONLY)
	PD	PAGE DISPLACEMENT (FOR HT = 1, 2, 4 ONLY)
	MCOUNT	MODULE COUNT (HT = 0 ONLY)
	NAME	UPPER PART OF SIX 8-BIT CHARACTER NAME OF RECORD
1	NAME	LOWER PART OF NAME
	COMMENTS	FIRST OF COMMENT FIELD
2 TO 7	COMMENTS	COMMENT FIELD

MEMORY IMAGE RECORD

WORD	59	56	55	44	43	28	27	12	11	0	
0	DATA 1			DATA 2			DATA 3		DATA 4		
1	DATA 4										
N									0	0	

ZERO FILL AS NECESSARY

Figure 3-1. Load File Format

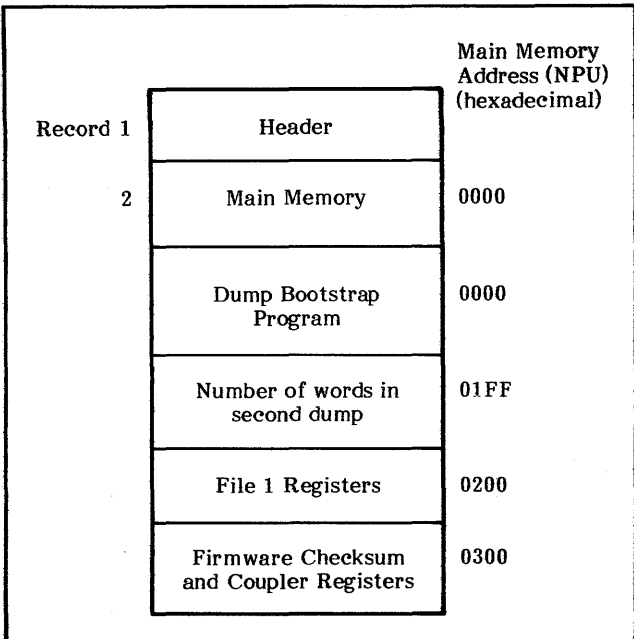

Loading is controlled by service messages, and must appear to start from the remote NPU itself. This is accomplished in one of two ways:

- Forced loading:

A command entered by the network operator requests loading or disabling an NPU. This starts the deadman timer in the remote NPU which forces the NPU to an inoperative status so it can be reloaded. Communication to the remote NPU takes the form of a force-load SM. Format of the message is:

Link/block headers	PFC =01	SFC =01
--------------------	---------	---------

No parameters are necessary. Source node is the NS; destination node is the remote NPU to be reloaded.

Figure 3-2. Format of 2551 Dump

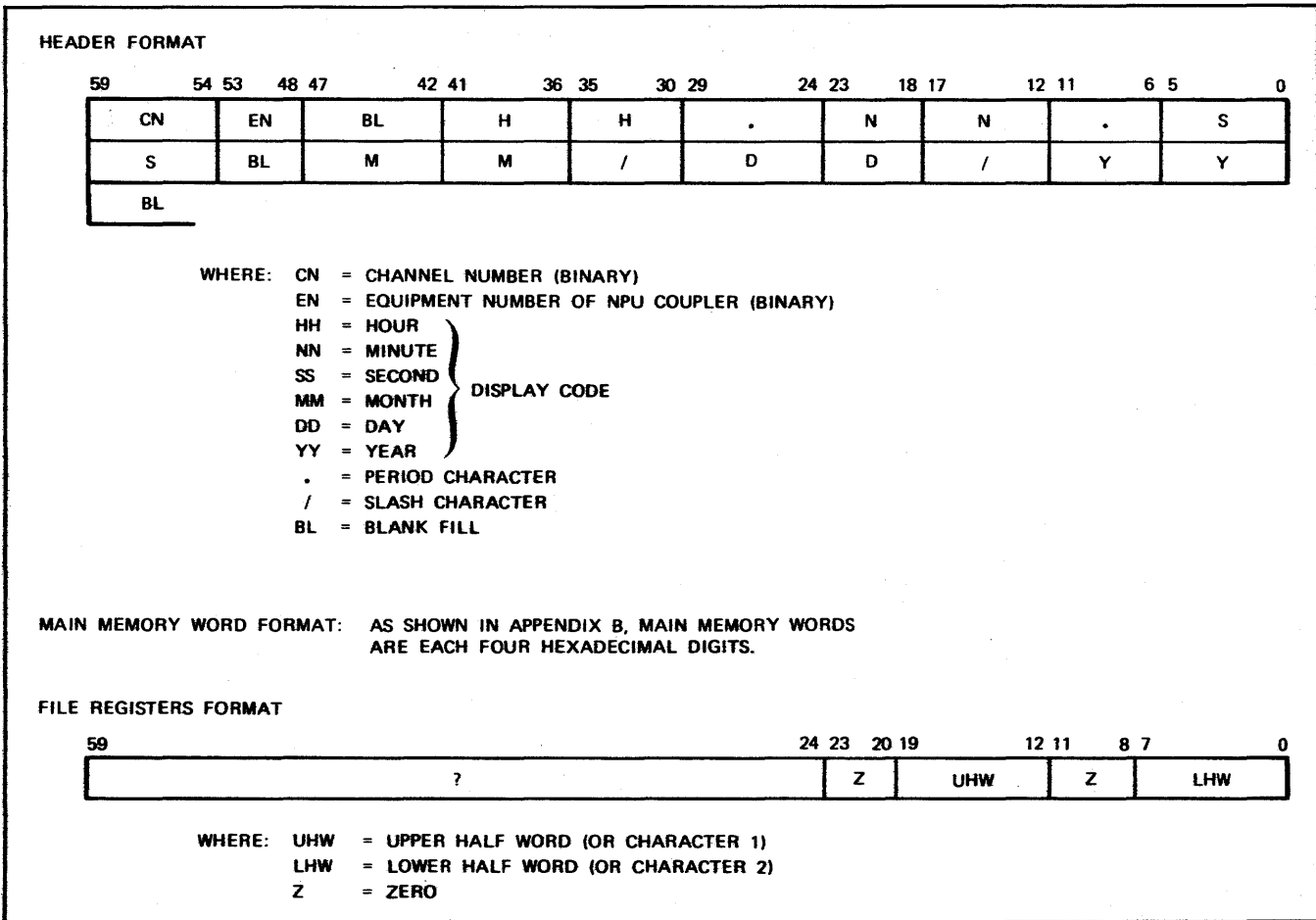

Figure 3-3. Format of Words in Dumps

- Failure-initiated loading:

Each remote NPU is provided with a deadman timer, which is reset periodically. If the timer expires, the NPU has failed. A bootstrap program loaded from a tape cassette starts the attempt to reload the NPU. This program sends a request for initialization over a trunk, using a nonsequenced element of the CDCCP protocol. This request is sent over the selected trunk for a time period and, should no reply be received, the request is repeated over a different trunk. The request is sent to neighbor NPUs, in sequence, until a reply is received. The NPU is programmed to receive the load operation over the replying trunk. If the loading does not commence after a predetermined interval, the deadman timer is activated and the NPU re-enters the request-initialization-mode sequence.

When a neighbor NPU accepts the nonsequenced element and calls its LIP to process the message, the LIP generates a load-request SM to the host which has the message source format shown previously. Parameters for the message are the neighbor node ID, and the port ID from the neighbor NPU to the remote NPU.

Upon receipt of the load-request SM from the neighbor NPU, NS in the host initiates the remote-NPU-load procedure if that NPU is enabled. The load/dump overlay is installed in the neighbor NPU that originated the load-request SM. As each block is loaded, the overlay program sends an overlay data response. Any error causes the procedure to restart with the load-request SM.

The overlay data is transmitted through the trunk to the remote NPU. The LIP in the neighbor NPU processes the data (programs) into frame format so that the data is compatible to the CDCCP trunk protocol. The general format of the protocol is:

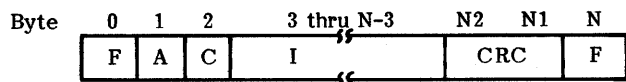

F Frame flag

A Trunk address

C Control

= 1 for remote NPU

= 0 for local NPU

RIM (17<sub>16</sub>) request for initialization (from remote NPU)

UA (73<sub>16</sub>) unnumbered acknowledgment

UI (13<sub>16</sub>) unnumbered information

SIM (07<sub>16</sub>) set initialization mode (from neighbor NPU)

I Information (allowed only on UI frame)

CRC Cyclic redundancy check

Data transmission and service messages use UI frames.

The loading and initialization of the remote NPU proceeds almost entirely under the control of a series of overlay-data SMs. The overlay-data service message has the basic form:

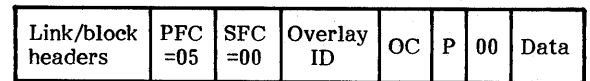

Overlay code = 0, 1, 2, or 3

(where applicable)

The four variations specified by the overlay code are:

Code = 0: Dumps the remote NPU

Code = 1: Loads neighbor NPU

Code = 2 Starts neighbor NPU to execute the loaded overlay (sends load information to remote NPU over trunk)

Code = 3: Clear overlay. This recycles pointers in the overlay to start a new loading attempt.

When a neighbor NPU detects an initialization request, it sends a load-request SM (format as shown previously) to NS requesting a load of the failed element. NS first installs the load/dump overlay in the neighbor NPU program using overlay-program-block SMs in order to provide the additional code necessary to perform the load of the failed NPU. Format of the overlay-program-block SM is:

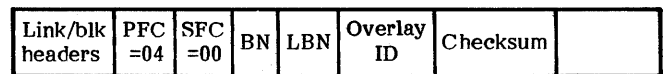

This block number

Last block number

Words m to n of overlay program for neighbor NPU

It should be noted that NS preempts an already existing overlay in the NPU in order to execute the load operation. Thus, a diagnostic overlay may be terminated to make room for the NPU load overlay.

Parameters for the load-overlay-data SM are: overlay ID, overlay code = 1, port from neighbor NPU to remote NPU, block count, beginning address to store this block of data in remote NPU, block checksum, and up to 105 words of overlay data. The overlay program attempts to load each block into the failed NPU using nonsequenced elements of the CDCCP protocol. The program in the failed NPU checksums and verifies each block received and causes an incorrectly received block to be retransmitted. Form of the load command as it is transmitted over the trunk is:

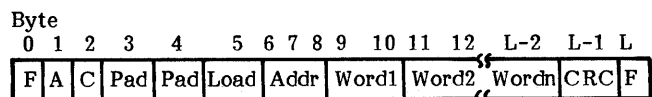

Pad Zero byte

Load Load flag



- Steps 1 and 2 are repeated, dumping all blocks of the remote NPU main memory within the region specified by the overlay in the neighbor NPU.

Then the loading process can begin.

The dumping operation is controlled by two types of SMs: The overlay-data SM dump commands, and the overlay-data SM dump response.

When NS is set to dump the remote NPU, it sends the neighbor NPU a series of overlay-data SM dump commands. Format of the SM is:

Link/block headers	PFC =05	SFC =00	Overlay ID	00	P	00	00	00	Begin Addr	End Addr
--------------------	---------	---------	------------	----	---	----	----	----	------------	----------

Required parameters are: overlay ID, overlay code = 0, port/subport number from the neighbor NPU to the remote NPU, and beginning and ending addresses of the remote NPU main memory to be dumped in this block. By regulating the size of the blocks, the NS can meter the amount of dump data from the remote NPU. Note that no more than 105 main memory words can be dumped in any one block.

Note that these overlay-data SMs include provisions to load the bootstrap and to execute the bootstrap in order to save files, registers, and micromemory checksum.

The neighbor NPU commands the data transfer by sending an unnumbered information (UI) frame to the remote NPU. This frame specifies the block of core to be dumped. The remote NPU replies with a UI frame prefacing the requested words of data (main memory).

After the remote NPU responds with the block of data requested, the neighbor NPU embeds this data in an overlay-data SM dump response. Format of the response is:

Link/block hdrs	PFC =05	SFC =40 <sub>16</sub>	Overlay ID	00	P	00	RC	00	Begin Addr	Data
-----------------	---------	-----------------------	------------	----	---	----	----	----	------------	------

Response code \_\_\_\_\_  
Data words (1 - 105) \_\_\_\_\_

Parameters for this SM are: overlay ID, overlay code = 0, port number from neighbor NPU to remote NPU, response code, beginning address of the dump, and 1 to 105 words of dumped main memory. Response code indicates success or failure of this dump block transmission.

## CONFIGURING NPUs

After the NPU is loaded, the host configures the unit by establishing all logical links and logical connections for

that NPU. A logical connection is the association of two stations made by the assignment of a network logical address. The network logical address is a set of three numbers: two node IDs followed by a connection number. The two node IDs represent the nodes at which each station interfaces to the network. The order in which they appear in the network logical address specifies the direction of the connection (the destination node appearing first, then the source node). The connection number specifies a full-duplex logical channel connecting the stations. Connection number zero is reserved as a permanent service channel for service message communications.

The set of logical connections which potentially exists between stations supported by a node pair is referred to as a logical link. A logical link must be explicitly established before logical connections may be assigned to it. (The service channel, which is designated as zero, is an exception to this rule.)

The network supervisor (NS) program and the communications supervisor (CS) program in the CYBER host are responsible for the control of logical links and connections, respectively, in the network. All logical links and connections are explicitly configured, reconfigured, and deleted by NS/CS use of network service messages (SMs). Note that the configuration is part of the general scheme of making a network operational. Reconfiguration and deletion can occur at any time while the network is running. All three processes are described together in this section. Configuration proceeds in three stages:

- establishing logical links
- configuring logical lines
- connecting terminal over the lines

NS establishes all logical links which the current state of the network permits. First NS notifies CS of each logical link to be established. The network also informs CS of the initial logical link regulation level. CS configures the lines or recovers the configuration status of the lines, depending upon NPU status. Whenever a line is reported to CS as operational, CS configures the line and attempts to connect each terminal on the line.

To connect the terminal, the line must be enabled. The terminal is connected by the NPU building a terminal control block (TCB) for the terminal. This process is initiated in the NPU when CS dispatches a configure or reconfigure-terminal SM. The message includes the CN assigned by CS for the connection. When the configure or reconfigure action has been performed, the block protocol is initiated and the connection is in use. CS is informed of the successful completion of the configuration by a normal response. NS is informed of an NPU entering this active state by the arrival of an NPU-initialized SM (in the case of restoring a failed NPU) or by the arrival of the first-trunk-status response SM (where the response indicates the trunk is operational). The latter occurs when an operational NPU rejoins the network.



---

Failure and recovery of CCP depends on a number of factors:

- **Host failure:** If a host fails, the NPU and its software must necessarily stop message processing.
- **NPU failure:** If an NPU fails, it must be reloaded and reinitiated from the host. Off-line diagnostic tests may be desirable during this period to help identify the cause of failure.
- **Logical link failure:** Host failure was mentioned above. Link CDCCP protocol failure leads to higher and higher levels of regulation until message traffic ceases on the link.
- **Line failure:** Lines are disconnected and terminal control blocks (TCBs) associated with the lines are deleted.
- **Terminal failure:** Terminal status is reported and message is discarded.

To aid recovery and to assure dependable network operations that involve the CCP, three sets of diagnostic programs are available.

- **Inline diagnostics.** These include CE error and alarm messages, statistics messages, halt code messages that specify the reason for an NPU failure, and off-line dumps.
- **Optional on-line diagnostic tests that allow checking of circuits to terminals.** These aids are available only if a network maintenance contract is purchased.
- **Off-line diagnostics.** These hardware tests for NPU circuits are described in detail in the Network Processor Unit Hardware Maintenance Manual.

The diagnostic commands are summarized in appendix B.

# CODED CHARACTER DATA INPUT, OUTPUT, AND CENTRAL MEMORY REPRESENTATION

A

This appendix describes the code and character sets used by host computer operating system local batch device drivers, magnetic tape drivers, and terminal communication products. Some software products assume that certain graphic or control characters are associated with specific binary code values for collating or syntax processing purposes. This appendix does not describe those associations for all products.

All references within this manual to the ASCII character set or the ASCII code set refer to the character set and code set defined in the American National Standard Code for Information Interchange (ASCII, ANSI Standard X3.4-1977). References in this manual to the ASCII character set do not necessarily apply to the ASCII code set.

## CHARACTER SETS AND CODE SETS

A character set differs from a code set. A character set is a set of graphic and/or control characters. A code set is a set of codes used to represent each character within a character set. Characters exist outside the computer system and communication network; codes are received, stored, retrieved, and transmitted within the computer system and network.

## GRAPHIC AND CONTROL CHARACTERS

A graphic character can be displayed at a terminal or printed by a line printer. Examples of graphic characters are the characters A through Z, a blank, and the digits 0 through 9. A control character initiates, modifies, or stops a control operation. An example of a control character is the backspace character, which moves the terminal carriage or cursor back one space. Although a control character is not a graphic character, some terminals can produce a graphic representation when they receive a control character.

## CODED AND BINARY CHARACTER DATA

Character codes can be interpreted as coded character data or as binary character data. Coded character data is converted from one code set representation to another as it enters or leaves the computer system; for example, data received from a terminal or sent to a magnetic tape unit is converted. Binary character data is not converted as it enters or leaves the system. Character codes are not converted when moved within the system; for example, data transferred to or from mass storage is not converted.

The distinction between coded character data and binary character data is important when reading or punching cards and when reading or writing magnetic tape. Only coded character data can be properly reproduced as characters on a line printer. Only binary character data can properly represent characters on a punched card when the data cannot be stored as display code.

The distinction between binary character data and characters represented by binary data (such as peripheral equipment instruction codes) is also important. Only such binary noncharacter data can properly reproduce characters on a plotter.

## FORMATTED AND UNFORMATTED CHARACTER DATA

Character codes can be interpreted by a product as formatted character data or as unformatted character data. Formatted data can be stored or retrieved by a product in the form of the codes described for coded character data in the remainder of this appendix, or formatted data can be altered to another form during storage or retrieval; for example, 1 can be stored as a character code or as an integer value. Treatment of unformatted data by a product includes both coded character data and binary character data as described in this appendix.

## NETWORK OPERATING SYSTEM

The Network Operating System (NOS) supports the following character sets:

- CDC graphic 64-character set
- CDC graphic 63-character set
- ASCII graphic 64-character set
- ASCII graphic 63-character set
- ASCII graphic 95-character set
- ASCII 128-character graphic and control set

Each installation must select either a 64-character set or a 63-character set. The differences between the codes of a 63-character set and the codes of a 64-character set are described under Character Set Anomalies. Any reference in this appendix to a 64-character set implies either a 63- or 64-character set unless otherwise stated.

To represent its six listed character sets in central memory, NOS supports the following code sets:

- 6-bit display code
- 12-bit ASCII code
- 6/12-bit display code

The 6-bit display code is a set of 6-bit codes from 00<sub>g</sub> to 77<sub>g</sub>.

The 12-bit ASCII code is the ASCII 7-bit code (as defined by ANSI Standard X3.4-1977) right-justified in a 12-bit byte. Assuming that the bits are numbered from the right starting with 0, bits 0 through 6 contain the ASCII code, bits 7 through 10 contain zeros, and bit 11 distinguishes the 12-bit ASCII 0000<sub>g</sub> code from the end-of-line byte. The 12-bit codes are 0001<sub>g</sub> through 0177<sub>g</sub> and 4000<sub>g</sub>.

The 6/12-bit display code is a combination of 6-bit codes and 12-bit codes. The 6-bit codes are 00g through 77g, excluding 74g and 76g. (The interpretation of the 00g and 63g codes is described under Character Set Anomalies later in this appendix.) The 12-bit codes begin with either 74g or 76g and are followed by a 6-bit code. Thus, 74g and 76g are considered escape codes and are never used as 6-bit codes within the 6/12-bit display code set. The 12-bit codes are 7401g, 7402g, 7404g, 7407g, and 7601g through 7677g. All other 12-bit codes (74xxg and 7600g) are undefined.

## CHARACTER SET ANOMALIES

The operating system input/output software and some products interpret two codes differently when the installation selects a 63-character set rather than a 64-character set. If an installation uses a 63-character set, the colon graphic character is always represented by a 63g code, display code 00g is undefined (it has no associated graphic or punched card code), and the % graphic does not exist.

If the installation uses a 64-character set, output of a 7404g 6/12-bit display code or a 00g display code produces a colon. A colon can be input only as a 7404g 6/12-bit display code. The use of undefined 6/12-bit display codes in output files produces unpredictable results and should be avoided.

Two consecutive 00g codes can be confused with an end-of-line byte and should be avoided.

## CHARACTER SET TABLES

The character set tables A-1 and A-2 are designed so that the user can find the character represented by a code (such as in a dump) or find the code that represents a character. To find the character represented by a code, the user looks up the code in the column listing the appropriate code set and then finds the character on that line in the column listing the appropriate character set. To find the code that represents a character, the user looks up the character and then finds the code on the same line in the appropriate column.

### Conversational Terminal Users

Table A-1 shows the character sets and code sets available to an Interactive Facility (IAF) user at an ASCII code terminal using an ASCII character set. Table A-9 (later in this appendix) shows the octal and hexadecimal 7-bit ASCII code for each ASCII character, and can be used to convert codes from octal to hexadecimal. (Under NOS using network product software, certain Terminal Interface Program commands require specification of an ASCII code.)

#### IAF Usage

When in normal time-sharing mode (specified by the IAF NORMAL command), IAF assumes the ASCII graphic 64-character set is used and translates all input and output to or from display code. When in ASCII time-sharing mode (specified by the IAF ASCII command), IAF assumes the ASCII 128-character set is used and translates all input and output to or from 6/12-bit display code.

The IAF user can convert a 6/12-bit code file to a 12-bit ASCII code file using the NOS FCOPY control statement. The resulting 12-bit ASCII file can be routed to a line printer but cannot be output through IAF.

IAF supports both character mode and transparent mode transmissions through the network. These transmission modes are described under Network Access Method Terminal Transmission Code Sets in this appendix. IAF treats character mode transmissions as coded character data; IAF converts these transmissions to or from either 6-bit or 6/12-bit display code. IAF treats transparent mode transmissions as binary character data; transparent mode communication between IAF and ASCII terminals using any parity setting occurs in the 12-bit ASCII code shown in table A-1.

### Local Batch Users

Table A-2 lists the CDC graphic 64-character set, the ASCII graphic 64-character set, and the ASCII graphic 95-character set. This table also lists the code sets and card keypunch codes (026 and 029) that represent the characters.

The 64-character sets use display code as their code set; the 95-character set uses 12-bit ASCII code. The 95-character set is composed of all the characters in the ASCII 128-character set that can be printed at a line printer (refer to Line Printer Output). Only 12-bit ASCII code files can be printed using the ASCII graphic 95-character set. To print a 6/12-bit display code file (usually created in IAF ASCII mode), the user must convert the file to 12-bit ASCII code. To do this, the NOS FCOPY control statement must be issued. The 95-character set is represented by the 12-bit ASCII codes 0040g through 0176g.

#### Line Printer Output

The batch character set printed depends on the print train used on the line printer to which the file is sent. The following are the print trains corresponding to each of the batch character sets:

<u>Character Set</u>	<u>Print Train</u>
CDC graphic 64-character set	596-1
ASCII graphic 64-character set	596-5
ASCII graphic 95-character set	596-6

The characters of the default 596-1 print train are listed in the table A-2 column labeled CDC Graphic (64-Character); the 596-5 print train characters are listed in the table A-2 column labeled ASCII Graphic (64-Character); and the 596-6 print train characters are listed in the table A-2 column labeled ASCII Graphic (95-Character).

If a transmission error occurs during the printing of a line, NOS prints the line again. The CDC graphic print train prints a concatenation symbol (↵) in the first printable column of a line containing errors. The ASCII print trains print an underline instead of the concatenation symbol.

If an unprintable character exists in a line (that is, a 12-bit ASCII code outside of the range 0040g through 0176g), the number sign (#) appears in the first printable column of a print line and a space replaces the unprintable character.

## Punched Card Input and Output

Under NOS, coded character data is exchanged with local batch card readers or card punches according to the translations shown in table A-2. As indicated in the table, additional card keypunch codes are available for input of the ASCII and CDC characters ] and [. The 95-character set cannot be read or punched as coded character data.

Depending on an installation or deadstart option, NOS assumes an input deck has been punched either in 026 or 029 keypunch code (regardless of the character set in use). The alternate keypunch codes can be specified by a 26 or 29 punched in columns 79 and 80 of any 6/7/9 card or 7/8/9 card. The specified code translation remains in effect throughout the job unless it is reset by specification of the alternate code translation on a subsequent 6/7/9 card or 7/8/9 card.

NOS keypunch code translation can also be changed by a card containing a 5/7/9 punch in column 1. A blank (no punch) in column 2 indicates 026 conversion mode; a 9 punch in column 2 indicates 029 conversion mode. The conversion change remains in effect until another change card is encountered or the job ends.

The 5/7/9 card also allows literal input when 4/5/6/7/8/9 is punched in column 2. Literal input can be used to read 80-column binary character data within a punched card deck of coded character data.

Literal cards are stored with each column in a 12-bit byte (a row 12 punch is represented by a 1 in bit 11, row 11 by bit 10, row 0 by bit 9, and rows 1 through 9 by bits 8 through 0 of the byte), 16 central memory words per card. Literal input cards are read until a card identical to the previous 5/7/9 card (4/5/6/7/8/9 in column 2) is read. The next card can specify a new conversion mode.

## **Remote Batch Users**

When card decks are read from remote batch devices, the ability to select alternate keypunch code translations depends upon the remote terminal equipment.

Remote batch terminal line printer, punched card, and plotter character set support is described under Input Deck Structure in the Remote Batch Facility (RBF) reference manual. RBF supports only character mode transmission to and from consoles through the network. Character mode is described under Network Access Method Terminal Transmission Code Sets in this appendix.

## **Magnetic Tape Users**

Coded character data to be copied from mass storage to magnetic tape is assumed to be represented in display code. NOS converts the data to external BCD code when writing a coded 7-track tape and to ASCII or EBCDIC code (as specified on the tape assignment statement) when writing a coded 9-track tape.

Because only 63 characters can be represented in 7-track even parity, one of the 64 display codes is lost in conversion to and from external BCD code. Figure A-1 shows the differences in conversion that depend on which character set (63 or 64) the system uses. The ASCII character for the specified character code is shown in parentheses. The output arrow shows how the display code changes when it is written on tape in external BCD. The input arrow shows how the external BCD code changes when the tape is read and converted to display code.

63-Character Set				
Display Code		External BCD		Display Code
00		16(%)		00
33(0)	Output →	12(0)	← Input	33(0)
63(:)		12(0)		33(0)
64-Character Set				
Display Code		External BCD		Display Code
00(:)		12(0)		33(0)
33(0)	Output →	12(0)	← Input	33(0)
63(%)		16(%)		63(%)

Figure A-1. Magnetic Tape Code Conversions

Tables A-3 and A-4 show the character set conversions for nine-track tapes. Table A-3 lists the conversions to and from 7-bit ASCII character code and 6-bit display code. Table A-4 lists the conversions between 8-bit EBCDIC character code and 6-bit display code. Table A-5 shows the character set conversions between 6-bit external BCD and 6-bit display code for seven-track tapes.

If a lowercase ASCII or EBCDIC code is read from a 9-track coded tape, it is converted to its uppercase 6-bit display code equivalent. To read and write lowercase ASCII or EBCDIC characters, the user must assign the tape in binary mode and then convert the binary character data.

During binary character data transfers to or from 9-track magnetic tape, the 7-bit ASCII codes shown in table A-3 are read or written unchanged; the 8-bit hexadecimal EBCDIC codes shown in table A-4 also can be read or written unchanged. ASCII and EBCDIC codes cannot be read or written to 7-track magnetic tape as binary character data.

Tables A-6 and A-7 list the magnetic tape codes and their punch code equivalents on IBM host computers.

Two CDC utility products, FORM and the 8-Bit Subroutines, can be used to convert to and from EBCDIC data. Table A-7 contains the octal values of each EBCDIC code right-justified in a 12-bit byte with zero fill. This 12-bit EBCDIC code can also be produced using FORM and the 8-Bit Subroutines.

TABLE A-1. CONVERSATIONAL TERMINAL CHARACTER SETS

ASCII Graphic (64-Character Set)	ASCII Character (128-Character Set)	Octal 6-Bit Display Code	Octal 6/12-Bit Display Code†	Octal 12-Bit ASCII Code	ASCII Graphic (64-Character Set)	ASCII Character (128-Character Set)	Octal 6-Bit Display Code	Octal 6/12-Bit Display Code†	Octal 12-Bit ASCII Code
: colon††		00††				^ circumflex		7402	0136
A	A	01	01	0101		: colon††		7404††	0072
B	B	02	02	0102		` grave accent		7407	0140
C	C	03	03	0103		a		7601	0141
D	D	04	04	0104		b		7602	0142
E	E	05	05	0105		c		7603	0143
F	F	06	06	0106		d		7604	0144
G	G	07	07	0107		e		7605	0145
H	H	10	10	0110		f		7606	0146
I	I	11	11	0111		g		7607	1047
J	J	12	12	0112		h		7610	0150
K	K	13	13	0113		i		7611	0151
L	L	14	14	0114		j		7612	0152
M	M	15	15	0115		k		7613	0153
N	N	16	16	0116		l		7614	0154
O	O	17	17	0117		m		7615	0155
P	P	20	20	0120		n		7616	0156
Q	Q	21	21	0121		o		7617	0157
R	R	22	22	0122		p		7620	0160
S	S	23	23	0123		q		7621	0161
T	T	24	24	0124		r		7622	0162
U	U	25	25	0125		s		7623	0163
V	V	26	26	0126		t		7624	0164
W	W	27	27	0127		u		7625	0165
X	X	30	30	0130		v		7626	0166
Y	Y	31	31	0131		w		7627	0167
Z	Z	32	32	0132		x		7630	0170
0	0	33	33	0060		y		7631	0171
1	1	34	34	0061		z		7632	0172
2	2	35	35	0062		{ left brace		7633	0173
3	3	36	36	0063		vert. line		7634	0174
4	4	37	37	0064		} right brace		7635	0175
5	5	40	40	0065		~ tilde		7636	0176
6	6	41	41	0066		NUL		7640	4000
7	7	42	42	0067		SOH		7641	0001
8	8	43	43	0070		STX		7642	0002
9	9	44	44	0071		ETX		7643	0003
+ plus	+ plus	45	45	0053		EOT		7644	0004
- minus	- minus	46	46	0055		ENQ		7645	0005
* asterisk	* asterisk	47	47	0052		ACK		7646	0006
/ slash	/ slash	50	50	0057		BEL		7647	0007
( l. paren.	( l. paren.	51	51	0050		BS		7650	0010
) r. paren.	) r. paren.	52	52	0051		HT		7651	0011
\$ dollar	\$ dollar	53	53	0044		LF		7652	0012
= equal to	= equal to	54	54	0075		VT		7653	0013
space	space	55	55	0040		FF		7654	0014
, comma	, comma	56	56	0054		CR		7655	0015
. period	. period	57	57	0056		SO		7656	0016
# number	# number	60	60	0043		SI		7657	0017
[ l. bracket	[ l. bracket	61	61	0133		DEL		7637	0177
] r. bracket	] r. bracket	62	62	0135		DLE		7660	0020
% percent††	% percent††	63††	63††	0045		DC1		7661	0021
" quote	" quote	64	64	0042		DC2		7662	0022
_ underline	_ underline	65	65	0137		DC3		7663	0023
! exclam.	! exclam.	66	66	0041		DC4		7664	0024
& ampersand	& ampersand	67	67	0046		NAK		7665	0025
' apostrophe	' apostrophe	70	70	0047		SYN		7666	0026
? question	? question	71	71	0077		ETB		7667	0027
< less than	< less than	72	72	0074		CAN		7670	0030
> grtr. than	> grtr. than	73	73	0076		EM		7671	0031
@ coml. at	@ coml. at	74				SUB		7672	0032
\ rev. slant	\ rev. slant	75	75	0134		ESC		7673	0033
^ circumflex		76				FS		7674	0034
; semicolon	; semicolon	77	77	0073		GS		7675	0035
@ coml. at	@ coml. at		7401	0100		RS		7676	0036
						US		7677	0037

† Generally available only on NOS, or through BASIC on NOS/BE.

†† The interpretation of this character or code depends on its context. Refer to Character Set Anomalies in the text.

TABLE A-2. LOCAL BATCH DEVICE CHARACTER SETS

CDC Graphic (64-Character Set)	ASCII Graphic (64-Character Set)	ASCII Graphic (95-Character Set)	Octal 6-Bit Display Code	Octal 6/12-Bit Display Code†	Octal 12-Bit ASCII Code	Card Keypunch Code	
						026	029
: colon <sup>††</sup>	: colon <sup>††</sup>		00 <sup>††</sup>			8-2	8-2
A	A	A	01	01	0101	12-1	12-1
B	B	B	02	02	0102	12-2	12-2
C	C	C	03	03	0103	12-3	12-3
D	D	D	04	04	0104	12-4	12-4
E	E	E	05	05	0105	12-5	12-5
F	F	F	06	06	0106	12-6	12-6
G	G	G	07	07	0107	12-7	12-7
H	H	H	10	10	0110	12-8	12-8
I	I	I	11	11	0111	12-9	12-9
J	J	J	12	12	0112	11-1	11-1
K	K	K	13	13	0113	11-2	11-2
L	L	L	14	14	0114	11-3	11-3
M	M	M	15	15	0115	11-4	11-4
N	N	N	16	16	0116	11-5	11-5
O	O	O	17	17	0117	11-6	11-6
P	P	P	20	20	0120	11-7	11-7
Q	Q	Q	21	21	0121	11-8	11-8
R	R	R	22	22	0122	11-9	11-9
S	S	S	23	23	0123	0-2	0-2
T	T	T	24	24	0124	0-3	0-3
U	U	U	25	25	0125	0-4	0-4
V	V	V	26	26	0126	0-5	0-5
W	W	W	27	27	0127	0-6	0-6
X	X	X	30	30	0130	0-7	0-7
Y	Y	Y	31	31	0131	0-8	0-8
Z	Z	Z	32	32	0132	0-9	0-9
0	0	0	33	33	0060	0	0
1	1	1	34	34	0061	1	1
2	2	2	35	35	0062	2	2
3	3	3	36	36	0063	3	3
4	4	4	37	37	0064	4	4
5	5	5	40	40	0065	5	5
6	6	6	41	41	0066	6	6
7	7	7	42	42	0067	7	7
8	8	8	43	43	0070	8	8
9	9	9	44	44	0071	9	9
+ plus	+ plus	+ plus	45	45	0053	12	12-8-6
- minus	- minus	- minus	46	46	0055	11	11
* asterisk	* asterisk	* asterisk	47	47	0052	11-8-4	11-8-4
/ slash	/ slash	/ slash	50	50	0057	0-1	0-1
( left paren.	( left paren.	( left paren.	51	51	0050	0-8-4	12-8-5
) right paren.	) right paren.	) right paren.	52	52	0051	12-8-4	11-8-5
\$ dollar	\$ dollar	\$ dollar	53	53	0044	11-8-3	11-8-3
= equal to	= equal to	= equal to	54	54	0075	8-3	8-6
space	space	space	55	55	0040	no punch	no punch
, comma	, comma	, comma	56	56	0054	0-8-3	0-8-3
. period	. period	. period	57	57	0056	12-8-3	12-8-3
≡ equivalence	# number	# number	60	60	0043	0-8-6	8-3
[ left bracket	[ left bracket	[ l. bracket	61	61	0133	8-7	12-8-2 or 12-0 <sup>†††</sup>
] right bracket	] right bracket	] r. bracket	62	62	0135	0-8-2	11-8-2 or 11-0 <sup>†††</sup>
% percent <sup>††</sup>	% percent <sup>††</sup>	% percent <sup>††</sup>	63	63	0045	8-6	0-8-4

TABLE A-2. LOCAL BATCH DEVICE CHARACTER SETS (Contd)

CDC Graphic (64-Character Set)	ASCII Graphic (64-Character Set)	ASCII Graphic (95-Character Set)	Octal 6-Bit Display Code	Octal 6/12-Bit Display Code†	Octal 12-Bit ASCII Code	Card Keypunch Code	
						026	029
≠ not equal	" quote	" quote	64	64	0042	8-4	8-7
⌢ concat.	_ underline	_ underline	65	65	0137	0-8-5	0-8-5
∨ logical OR	! exclamation	! exclamation	66	66	0041	11-0	12-8-7
∧ logical AND	& ampersand	& ampersand	67	67	0046	0-8-7	12
↑ superscript	' apostrophe	' apostrophe	70	70	0047	11-8-5	8-5
↓ subscript	? question	? question	71	71	0077	11-8-6	0-8-7
< less than	< less than	< less than	72	72	0074	12-0	12-8-4
> greater than	> greater than	> greater than	73	73	0076	11-8-7	0-8-6
<= less/equal	@ commercial at		74			8-5	8-4
>= greater/equal	\ reverse slant	\ rev. slant	75	75	0134	12-8-5	0-8-2
¬ logical NOT	^ circumflex		76			12-8-6	11-8-7
; semicolon	; semicolon	; semicolon	77	77	0073	12-8-7	11-8-6
		@ comL. at		7401	0100		
		^ circumflex		7402	0136		
		: colon††		7404††	0072		
		` grave accent		7407	0140		
		a		7601	0141		
		b		7602	0142		
		c		7603	0143		
		d		7604	0144		
		e		7605	0145		
		f		7606	0146		
		g		7607	0147		
		h		7610	0150		
		i		7611	0151		
		j		7612	0152		
		k		7613	0153		
		l		7614	0154		
		m		7615	0155		
		n		7616	0156		
		o		7617	0157		
		p		7620	0160		
		q		7621	0161		
		r		7622	0162		
		s		7623	0163		
		t		7624	0164		
		u		7625	0165		
		v		7626	0166		
		w		7627	0167		
		x		7630	0170		
		y		7631	0171		
		z		7632	0172		
		{ left brace		7633	0173		
		vert. line		7634	0174		
		} right brace		7635	0175		
		- tilde		7636	0176		

†Generally available only on NOS, or through BASIC on NOS/BE.

††The interpretation of this character or code depends on its context. Refer to Character Set Anomalies in the text.

†††Available for input only, on NOS.

TABLE A-3. ASCII 9-TRACK CODED TAPE CONVERSION

ASCII				Display Code <sup>†††</sup>		ASCII				Display Code <sup>†††</sup>	
Code Conversion <sup>†</sup>		Character and Code Conversion <sup>††</sup>				Code Conversion <sup>†</sup>		Character and Code Conversion <sup>††</sup>			
Code (Hex)	Char	Code (Hex)	Char	ASCII Char	Code (Octal)	Code (Hex)	Char	Code (Hex)	Char	ASCII Char	Code (Octal)
20	space	00	NUL	space	55	40	@	60	`	@	74
21	!	7D	J	!	66	41	A	61	a	A	01
22	"	02	STX	"	64	42	B	62	b	B	02
23	#	03	ETX	#	60	43	C	63	c	C	03
24	\$	04	EOT	\$	53	44	D	64	d	D	04
25	%	05	ENQ	%	63	45	E	65	e	E	05
25	%	05	ENQ	space	55	46	F	66	f	F	06
26	&	06	ACK	&	67	47	G	67	g	G	07
27	'	07	BEL	'	70	48	H	68	h	H	10
28	(	08	BS	(	51	49	I	69	i	I	11
29	)	09	HT	)	52	4A	J	6A	j	J	12
2A	*	0A	LF	*	47	4B	K	6B	k	K	13
2B	+	0B	VT	+	45	4C	L	6C	l	L	14
2C	,	0C	FF	,	56	4D	M	6D	m	M	15
2D	-	0D	CR	-	46	4E	N	6E	n	N	16
2E	.	0E	SO	.	57	4F	O	6F	o	O	17
2F	/	0F	SI	/	50	50	P	70	p	P	20
30	0	10	DLE	0	33	51	Q	71	q	Q	21
31	1	11	DC1	1	34	52	R	72	r	R	22
32	2	12	DC2	2	35	53	S	73	s	S	23
33	3	13	DC3	3	36	54	T	74	t	T	24
34	4	14	DC4	4	37	55	U	75	u	U	25
35	5	15	NAK	5	40	56	V	76	v	V	26
36	6	16	SYN	6	41	57	W	77	w	W	27
37	7	17	ETB	7	42	58	X	78	x	X	30
38	8	18	CAN	8	43	59	Y	79	y	Y	31
39	9	19	EM	9	44	5A	Z	7A	z	Z	32
3A	:	1A	SUB	:	00	5B	[	1C	FS	[	61
Display code 00 is undefined at sites using the 63-character set.											
3A	:	1A	SUB	:	63	5C	\	7C		\	75
3B	;	1B	ESC	;	77	5D	]	01	SOH	]	62
3C	<	7B	{	<	72	5E	^	7E	-	^	76
3D	=	1D	GS	=	54	5F	_	7F	DEL	_	65
3E	>	1E	RS	>	73						
3F	?	1F	US	?	71						

<sup>†</sup>When these characters are copied from or to a tape, the characters remain the same and the code changes from/to ASCII to/from display code.

<sup>††</sup>These characters do not exist in display code. When the characters are copied from a tape, each ASCII character is changed to an alternate display code character. The corresponding codes are also changed. Example: When the system copies a lowercase a, 61<sub>16</sub>, from tape, it writes an uppercase A, 01<sub>16</sub>.

<sup>†††</sup>A display code space always translates to an ASCII space.



TABLE A-4. EBCDIC 9-TRACK CODED TAPE CONVERSION

EBCDIC				Display Code <sup>†††</sup>		EBCDIC				Display Code <sup>†††</sup>	
Code Conversion <sup>†</sup>		Character and Code Conversion <sup>††</sup>				Code Conversion <sup>†</sup>		Character and Code Conversion <sup>††</sup>			
Code (Hex)	Char	Code (Hex)	Char	ASCII Char	Code (Octal)	Code (Hex)	Char	Code (Hex)	Char	ASCII Char	Code (Octal)
40	space	00	NUL	space	55	C6	F	86	f	F	06
4A	¢	1C	IFS	[	61	C7	G	87	g	G	07
4B	.	0E	SO	.	57	C8	H	88	h	H	10
4C	<	C0	¸	<	72	C9	I	89	i	I	11
4D	(	16	BS	(	51	D1	J	91	j	J	12
4E	+	0B	VT	+	45	D2	K	92	k	K	13
4F		D0	¸	!	66	D3	L	93	l	L	14
50	&	2E	ACK	&	67	D4	M	94	m	M	15
5A	!	01	SOH	]¸	62	D5	N	95	n	N	16
5B	\$	37	EOT	\$	53	D6	O	96	o	O	17
5C	*	25	LF	*	47	D7	P	97	p	P	20
5D	)	05	HT	)	52	D8	Q	98	q	Q	21
5E	;	27	ESC	;	77	D9	R	99	r	R	22
5F	¸	A1	¸	/	76	E0	\	6A	¸	\	75
60	-	0D	CR	-	46	E2	S	A2	s	S	23
61	'	0F	SI	'	50	E3	T	A3	t	T	24
6B	/	0C	FF	/	56	E4	U	A4	u	U	25
6C	%	2D	ENQ	%	63	E5	V	A5	v	V	26
6E	>	1E	DEL	>	73	E6	W	A6	w	W	27
6F	?	1F	IUS	?	71	E7	X	A7	x	X	30
7A	:	3F	SUB	:	63	E8	Y	A8	y	Y	31
Display code 00 is undefined at sites using the 63-character set.											
7A	:	3F	SUB	:	63	E9	Z	A9	z	Z	32
7B	#	03	ETX	#	60	F0	0	10	DLE	0	33
7C	@	79	\	@	74	F1	1	11	DC1	1	34
7D	'	2F	BEL	'	70	F2	2	12	DC2	2	35
7E	=	1D	IGS	=	54	F3	3	13	TM	3	36
7F	"	02	STX	"	64	F4	4	3C	DC4	4	37
C1	A	81	a	A	01	F5	5	3D	NAK	5	40
C2	B	82	b	B	02	F6	6	32	SYN	6	41
C3	C	83	c	C	03	F7	7	26	ETB	7	42
C4	D	84	d	D	04	F8	8	18	CAN	8	43
C5	E	85	e	E	05	F9	9	19	EM	9	44

<sup>†</sup>ALL EBCDIC codes not listed translate to display code 55g (space). A display code space always translates to an EBCDIC space.

<sup>††</sup>These characters do not exist in display code. When the characters are copied from a tape, each EBCDIC character is changed to an alternate display code character. The corresponding codes are also changed. Example: When the system copies a lowercase a, 81<sub>16</sub>, from tape, it writes an uppercase A, 01<sub>16</sub>.

<sup>†††</sup>When these characters are copied from or to a tape, the characters remain the same (except EBCDIC codes 4A<sub>16</sub>, 4F<sub>16</sub>, 5A<sub>16</sub>, and 5F<sub>16</sub>) and the code changes from/to EBCDIC to/from display code.

TABLE A-5. 7-TRACK CODED TAPE CONVERSIONS

External BCD	ASCII Character	Octal Display Code	External BCD	ASCII Character	Octal Display Code
01	1	34	40	-	46
02	2	35	41	J	12
03	3	36	42	K	13
04	4	37	43	L	14
05	5	40	44	M	15
06	6	41	45	N	16
07	7	42	46	O	17
10	8	43	47	P	20
11	9	44	50	Q	21
12†	0	33	51	R	22
13	=	54	52	!	66
14	"	64	53	\$	53
15	@	74	54	*	47
16†	%	63	55	.	70
17	[	61	56	?	71
20	space	55	57	>	73
21	/	50	60	+	45
22	S	23	61	A	01
23	T	24	62	B	02
24	U	25	63	C	03
25	V	26	64	D	04
26	W	27	65	E	05
27	X	30	66	F	06
30	Y	31	67	G	07
31	Z	32	70	H	10
32	]	62	71	I	11
33	^	56	72	<	72
34	(	51	73	.	57
35	#	65	74	)	52
36	&	60	75	\	75
37		67	76	^	76
			77	;	77

†As explained in the text of this appendix, conversion of these codes depends on whether the tape is being read or written.

TABLE A-6. AMERICAN NATIONAL STANDARD CODE FOR INFORMATION INTERCHANGE (ASCII) PUNCHED CARD CODES AND EBCDIC TRANSLATION

		0	0	0	0	0	0	0	0	1	1	1	1	1	1	1	1
		0	0	0	0	0	0	0	0	0	0	0	0	0	0	0	0
		0	1	2	3	4	5	6	7	8	9	10	11	12	13	14	15
		0	1	2	3	4	5	6	7	8	9	10	11	12	13	14	15
b8 b7 b6 b5	COL	0	1	2	3	4	5	6	7	8	9	10	11	12	13	14	15
b4 b3 b2 b1	ROW	0	1	2	3	4	5	6	7	8	9	10	11	12	13	14	15
0 0 0 0	0	NUL 12-0-9-8-1 NUL 00	DLE 12-11-9-8-1 DLE 10	SP no-punch SP 40	0 0 FO	@ 8-4 @ 7C	P 11-7 P D7	' 8-1 79	p 12-11-7 p 97	11-0-9-8-1 DS 20	12-11-0-9-8-1 30	12-0-9-1 41	12-11-9-8 58	12-11-0-9-6 76	12-11-8-7 9F	12-11-0-8 88	12-11-9-8-4 DC
0 0 0 1	1	SOH 12-9-1 SOH 01	DC1 11-9-1 DC1 11	 12-8-7 4F	1 1 F1	A 12-1 A C1	Q 11-8 Q D8	a 12-0-1 a 81	q 12-11-8 q 98	0-9-1 SOS 21	9-1 31	12-0-9-2 42	11-8-1 59	12-11-0-9-7 77	11-0-8-1 A0	12-11-0-9 B9	12-11-9-8-5 DD
0 0 1 0	2	STX 12-9-2 STX 02	DC2 11-9-2 DC2 12	" 8-7 7F	2 2 F2	B 12-2 B C2	R 11-9 R D9	b 12-0-2 b 82	r 12-11-9 r 99	0-9-2 FS 22	11-9-8-2 CC 1A	12-0-9-3 43	11-0-9-2 62	12-11-0-9-8 78	11-0-8-2 AA	12-11-0-8-2 BA	12-11-9-8-6 DE
0 0 1 1	3	ETX 12-9-3 ETX 03	DC3 11-9-3 TM 13	# 8-3 7B	3 3 F3	C 12-3 C C3	S 0-2 S E2	c 12-0-3 c 83	s 11-0-2 s A2	0-9-3 23	9-3 33	12-0-9-4 44	11-0-9-3 63	12-0-8-1 80	11-0-8-3 AB	12-11-0-8-3 BB	12-11-9-8-7 DF
0 1 0 0	4	EOT 9-7 EOT 37	DC4 9-8-4 DC4 3C	\$ 11-8-3 5B	4 4 F4	D 12-4 D C4	T 0-3 T E3	d 12-0-4 d 84	t 11-0-3 t A3	0-9-4 BYP 24	9-4 PN 34	12-0-9-5 45	11-0-9-4 64	12-0-8-2 8A	11-0-8-4 AC	12-11-0-8-4 BC	11-0-9-8-2 EA
0 1 0 1	5	ENQ 0-9-8-5 ENQ 2D	NAK 9-8-5 NAK 3D	% 0-8-4 6C	5 5 F5	E 12-5 E C5	U 0-4 U E4	e 12-0-5 e 85	u 11-0-4 u A4	11-9-5 NL 15	9-5 RS 35	12-0-9-6 46	11-0-9-5 65	12-0-8-3 8B	11-0-8-5 AD	12-11-0-8-5 BD	11-0-9-8-3 EB
0 1 1 0	6	ACK 0-9-8-6 ACK 2E	SYN 9-2 SYN 32	& 12 & 50	6 6 F6	F 12-6 F C6	V 0-5 V E5	f 12-0-6 f 86	v 11-0-5 v A5	12-9-6 LC 06	9-6 UC 36	12-0-9-7 47	11-0-9-6 66	12-0-8-4 8C	11-0-8-6 AE	12-11-0-8-6 BE	11-0-9-8-4 EC
0 1 1 1	7	BEL 0-9-8-7 BEL 2F	ETB 0-9-6 ETB 26	' 8-5 7D	7 7 F7	G 12-7 G C7	W 0-6 W E6	g 12-0-7 g 87	w 11-0-6 w A6	11-9-7 IL 17	12-9-8 GE 08	12-0-9-8 48	11-0-9-7 67	12-0-8-5 8D	11-0-8-7 AF	12-11-0-8-7 BF	11-0-9-8-5 ED
1 0 0 0	8	BS 11-9-6 BS 16	CAN 11-9-8 CAN 18	( 12-8-5 4D	8 8 F8	H 12-8 H C8	X 0-7 X E7	h 12-0-8 h 88	x 11-0-7 x A7	0-9-8 28	9-8 38	12-8-1 49	11-0-9-8 68	12-0-8-6 8E	12-11-0-8-1 B0	12-0-9-8-2 CA	11-0-9-8-6 EE
1 0 0 1	9	HT 12-9-5 HT 05	EM 11-9-8-1 EM 19	) 11-8-5 5D	9 9 F9	I 12-9 I C9	Y 0-8 Y E8	i 12-0-9 i 89	y 11-0-8 y A8	0-9-8-1 29	9-8-1 39	12-11-9-1 51	0-8-1 69	12-0-8-7 8F	12-11-0-1 B1	12-0-9-8-3 CB	11-0-9-8-7 EF
1 0 1 0	10 (A)	LF 0-9-5 LF 25	SUB 9-8-7 SUB 3F	* 11-8-4 5C	8-2 7A	J 11-1 J D1	Z 0-9 Z E9	j 12-11-1 j 91	z 11-0-9 z A9	0-9-8-2 SM 2A	9-8-2 3A	12-11-9-2 52	12-11-0 70	12-11-8-1 90	12-11-0-2 B2	12-0-9-8-4 CC	12-11-0-9-8-2 (LVM) FA
1 0 1 1	11 (B)	VT 12-9-8-3 VT 0B	ESC 0-9-7 ESC 27	+ 12-8-6 4E	; 11-8-6 5E	K 11-2 K D2	12-8-2 4A	k 12-11-2 k 92	{ 12-0 C0	0-9-8-3 CU2 2B	9-8-3 CU3 3B	12-11-9-3 53	12-11-0-9-1 71	12-11-8-2 9A	12-11-0-3 B3	12-0-9-8-5 CD	12-11-0-9-8-3 FB
1 1 0 0	12 (C)	FF 12-9-8-4 FF 0C	FS 11-9-8-4 IFS 1C	< 12-8-4 4C	< 12-8-4 4C	L 11-3 L D3	0-8-2 E0	l 12-11-3 l 93	 12-11 6A	0-9-8-4 2C	12-9-4 PF 04	12-11-9-4 54	12-11-0-9-2 72	12-11-8-3 9B	12-11-0-4 B4	12-0-9-8-6 CE	12-11-0-9-8-4 FC
1 1 0 1	13 (D)	CR 12-9-8-5 CR 0D	GS 11-9-8-5 IGS 1D	- 11 60	= 8-6 7E	M 11-4 MD4	11-8-2 5A	m 12-11-4 m 94	~ 11-0 D0	12-9-8-1 RLF 09	11-9-4 RES 14	12-11-9-5 55	12-11-0-9-3 73	12-11-8-4 9C	12-11-0-5 B5	12-0-9-8-7 CF	12-11-0-9-8-5 FD
1 1 1 0	14 (E)	SO 12-9-8-6 SO 0E	RS 11-9-8-6 IRS 1E	12-8-3 4B	> 0-8-6 6E	N 11-5 ND5	11-8-7 5F	n 12-11-5 n 95	~ 11-0-1 A1	12-9-8-2 SMM 0A	9-8-6 3E	12-11-9-6 56	12-11-0-9-4 74	12-11-8-5 9D	12-11-0-6 B6	12-11-9-8-2 DA	12-11-0-9-8-6 FE
1 1 1 1	15 (F)	SI 12-9-8-7 SI 0F	US 11-9-8-7 IUS 1F	/ 0-1 61	? 0-8-7 6F	O 11-6 OD6	0-8-5 6D	o 12-11-6 o 96	DEL 12-9-7 DEL 07	11-9-8-3 CU1 1B	11-0-9-1 E1	12-11-9-7 57	12-11-0-9-5 75	12-11-8-6 9E	12-11-0-7 B7	12-11-9-8-3 DB	EO 12-11-0-9-8-7 FF

LEGEND

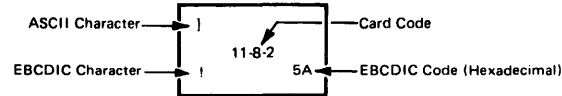

TABLE A-7. EXTENDED BINARY CODED DECIMAL INTERCHANGE CODE (EBCDIC)  
PUNCHED CARD CODES AND ASCII TRANSLATION

BITS 4 5 6 7	1ST HEX 2ND	0	1	2	3	4	5	6	7	8	9	A (10)	B (11)	C (12)	D (13)	E (14)	F (15)
		0 0 0 0	0 0 0 1	0 0 1 0	0 0 1 1	0 1 0 0	0 1 0 1	0 1 1 0	0 1 1 1	1 0 0 0	1 0 0 1	1 0 1 0	1 0 1 1	1 1 0 0	1 1 0 1	1 1 1 0	1 1 1 1
0 0 0 0	0	NUL 12-0-9-8-1 NUL 00	DLE 12-11-9-8-1 DLE 10	DS 11-0-9-8-1 80	12-11-0-9-8-1 90	SP no punch SP 20	& 12 & 26	- 11 - 2D	12-11-0 BA	12-0-8-1 C3	12-11-8-1 CA	11-0-8-1 D1	12-11-0-8-1 D8	12-0 7B	11-0 7D	0-8-2 5C	0 0 30
0 0 0 1	1	SOH 12-9-1 SOH 01	DC1 11-9-1 DC1 11	SOS 0-9-1 81	9-1 91	12-0-9-1 A0	12-11-9-1 A9	/- 0-1 2F	12-11-0-9-1 BB	a 12-0-1 61	i 12-11-1 6A	~ 11-0-1 7E	12-11-0-1 D9	A 12-1 A 41	J 11-1 J 4A	11-0-9-1 9F	1 1 31
0 0 1 0	2	STX 12-9-2 STX 02	DC2 11-9-2 DC2 12	FS 0-9-2 82	SYN 9-2 SYN 16	12-0-9-2 A1	12-11-9-2 AA	11-0-9-2 B2	12-11-0-9-2 BC	b 12-0-2 62	k 12-11-2 6B	s 11-0-2 73	12-11-0-2 DA	B 12-2 B 42	K 11-2 K 4B	S 0-2 S 53	2 2 32
0 0 1 1	3	ETX 12-9-3 ETX 03	TM 11-9-3 DC3 13	0-9-3 83	9-3 93	12-0-9-3 A2	12-11-9-3 AB	11-0-9-3 B3	12-11-0-9-3 BD	c 12-0-3 63	l 12-11-3 6C	t 11-0-3 74	12-11-0-3 DB	C 12-3 C 43	L 11-3 L 4C	T 0-3 T 54	3 3 33
0 1 0 0	4	PF 12-9-4 9C	RES 11-9-4 9D	BYP 0-9-4 84	PN 9-4 94	12-0-9-4 A3	12-11-9-4 AC	11-0-9-4 B4	12-11-0-9-4 BE	d 12-0-4 64	m 12-11-4 6D	u 11-0-4 75	12-11-0-4 DC	D 12-4 D 44	M 11-4 M 4D	U 0-4 U 55	4 4 34
0 1 0 1	5	HT 12-9-5 HT 09	NL 11-9-5 85	LF 0-9-5 LF 0A	RS 9-5 95	12-0-9-5 A4	12-11-9-5 AD	11-0-9-5 B5	12-11-0-9-5 BF	e 12-0-5 65	n 12-11-5 6E	v 11-0-5 76	12-11-0-5 DD	E 12-5 E 45	N 11-5 N 4E	V 0-5 V 56	5 5 35
0 1 1 0	6	LC 12-9-6 86	BS 11-9-6 BS 08	ETB 0-9-6 ETB 17	UC 9-6 96	12-0-9-6 A5	12-11-9-6 AE	11-0-9-6 B6	12-11-0-9-6 C0	f 12-0-6 66	o 12-11-6 6F	w 11-0-6 77	12-11-0-6 DE	F 12-6 F 46	O 11-6 O 4F	W 0-6 W 57	6 6 36
0 1 1 1	7	DEL 12-9-7 DEL 7F	IL 11-9-7 87	ESC 0-9-7 ESC 1B	EOT 9-7 EOT 04	12-0-9-7 A6	12-11-9-7 AF	11-0-9-7 B7	12-11-0-9-7 C1	g 12-0-7 67	p 12-11-7 67	x 11-0-7 78	12-11-0-7 DF	G 12-7 G 47	P 11-7 P 50	X 0-7 X 58	7 7 37
1 0 0 0	8	GE 12-9-8 97	CAN 11-9-8 CAN 18	0-9-8 88	9-8 98	12-0-9-8 A7	12-11-9-8 B0	11-0-9-8 B8	12-11-0-9-8 C2	h 12-0-8 68	q 12-11-8 67	y 11-0-8 79	12-11-0-8 E0	H 12-8 H 48	Q 11-8 Q 51	Y 0-8 Y 59	8 8 38
1 0 0 1	9	RLF 12-9-8-1 8D	EM 11-9-8-1 EM 19	0-9-8-1 89	9-8-1 99	12-8-1 A8	11-8-1 B1	0-8-1 B9	8-1 60	i 12-0-9 69	r 12-11-9 62	z 11-0-9 7A	12-11-0-9 E1	I 12-9 I 49	R 11-9 R 52	Z 0-9 Z 5A	9 9 39
1 0 1 0	A (10)	SMM 12-9-8-2 8E	CC 11-9-8-2 92	SM 0-9-8-2 8A	9-8-2 9A	12-8-2 5B	11-8-2 5D	12-11 7C	8-2 3A	12-0-8-2 C4	12-11-8-2 CB	11-0-8-2 D2	12-11-0-8-2 E2	12-0-9-8-2 E8	12-11-9-8-2 EE	11-0-9-8-2 F4	(LVM) 12-11-0-9-8-2 FA
1 0 1 1	B (11)	VT 12-9-8-3 VT 0B	CU1 11-9-8-3 8F	CU2 0-9-8-3 8B	CU3 9-8-3 9B	12-8-3 2E	\$ 11-8-3 24	0-8-3 2C	# 8-3 23	12-0-8-3 C5	12-11-8-3 CC	11-0-8-3 D3	12-11-0-8-3 E3	12-0-9-8-3 E9	12-11-9-8-3 EF	11-0-9-8-3 F5	12-11-0-9-8-3 FB
1 1 0 0	C (12)	FF 12-9-8-4 FF 0C	IFS 11-9-8-4 FS 1C	0-9-8-4 8C	DC4 9-8-4 DC4 14	< 12-8-4 3C	* 11-8-4 2A	% 0-8-4 25	@ 8-4 24	12-0-8-4 C6	12-11-8-4 CD	11-0-8-4 D4	12-11-0-8-4 E4	J <sup>h</sup> 12-0-9-8-4 EA	12-11-9-8-4 F0	h <sup>h</sup> 11-0-9-8-4 F6	12-11-0-9-8-4 FC
1 1 0 1	D (13)	CR 12-9-8-5 CR 0D	IGS 11-9-8-5 GS 1D	ENQ 0-9-8-5 ENQ 05	NAK 9-8-5 NAK 15	( 12-8-5 28	) 11-8-5 29	0-8-5 5F	8-5 27	12-0-8-5 C7	12-11-8-5 CE	11-0-8-5 D5	12-11-0-8-5 E5	12-0-9-8-5 EB	12-11-9-8-5 F1	11-0-9-8-5 F7	12-11-0-9-8-5 FD
1 1 1 0	E (14)	SO 12-9-8-6 SO 0E	IRS 11-9-8-6 RS 1E	ACK 0-9-8-6 ACK 06	9-8-6 9E	+ 12-8-6 2B	; 11-8-6 3B	> 0-8-6 3E	= 8-6 3D	12-0-8-6 C8	12-11-8-6 CF	11-0-8-6 D6	12-11-0-8-6 E6	U <sup>h</sup> 12-0-9-8-6 EC	12-11-9-8-6 F2	11-0-9-8-6 F8	12-11-0-9-8-6 FE
1 1 1 1	F (15)	SI 12-9-8-7 SI 0F	IUS 11-9-8-7 US 1F	BEL 0-9-8-7 BEL 07	SUB 9-8-7 SUB 1A	 12-8-7 21	^ 11-8-7 5E	? 0-8-7 3F	" 8-7 22	12-0-8-7 C9	12-11-8-7 D0	11-0-8-7 D7	12-11-0-8-7 E7	12-0-9-8-7 ED	12-11-9-8-7 F3	11-0-9-8-7 F9	12-11-0-9-8-7 FF

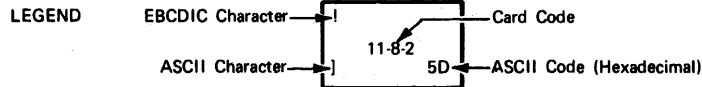

TABLE A-8. FULL EBCDIC CHARACTER SET

Hexa- decimal EBCDIC Code	Octal 12-Bit EBCDIC Code	EBCDIC Graphic Character†	EBCDIC Control Character	Hexa- decimal EBCDIC Code	Octal 12-Bit EBCDIC Code	EBCDIC Graphic Character†	EBCDIC Control Character
00	0000		NUL	41	0101		undefined
01	0001		SOH	thru	thru		
02	0002		STX	49	0111		
03	0003		ETX	4A	0112	¢	
04	0004		PF	4B	0113	.	
05	0005		HT	4C	0114	<	
06	0006		LC	4D	0115	(	
07	0007		DEL	4E	0116	+	
08	0010		undefined	4F	0117		
09	0011		undefined	50	0120	&	
0A	0012		SMM	51	0121		undefined
0B	0013		VT	thru	thru		
0C	0014		FF	59	0131		
0D	0015		CR	5A	0132	!	
0E	0016		SO	5B	0133	\$	
0F	0017		SI	5C	0134	*	
10	0020		DLE	5D	0135	)	
11	0021		DC1	5E	0136	;	
12	0022		DC2	5F	0137	]	
13	0023		TM	60	0140	-	
14	0024		RES	61	0141	/	
15	0025		NL	62	0142		undefined
16	0026		BS	thru	thru		
17	0027		IL	69	0151	!	
18	0030		CAN	6A	0152	!	
19	0031		EM	6B	0153	/	
1A	0032		CC	6C	0154	x	
1B	0033		CU1	6D	0155		
1C	0034		IFS	6E	0156	>	
1D	0035		IGS	6F	0157	?	
1E	0036		IRS	70	0160		undefined
1F	0037		IUS	thru	thru		
20	0040		DS	78	0170		
21	0041		SOS	79	0171	.	
22	0042		FS	7A	0172	:	
23	0043		undefined	7B	0173	#	
24	0044		BYP	7C	0174	@	
25	0045		LF	7D	0175	'	
26	0046		ETB or EOB	7E	0176	=	
27	0047		ESC or PRE	7F	0177	"	
28	0050		undefined	80	0200		undefined
29	0051		undefined	81	0201	a	
2A	0052		SM	82	0202	b	
2B	0053		CU2	83	0203	c	
2C	0054		undefined	84	0204	d	
2D	0055		ENQ	85	0205	e	
2E	0056		ACK	86	0206	f	
2F	0057		BEL	87	0207	g	
30	0060		undefined	88	0210	h	
31	0061		undefined	89	0211	i	
32	0062		SYN	8A	0212		undefined
33	0063		undefined	thru	thru		
34	0064		PN	90	0220		
35	0065		RS	91	0221	j	
36	0066		UC	92	0222	k	
37	0067		EOT	93	0223	l	
38	0070		undefined	94	0224	m	
39	0071		undefined	95	0225	n	
3A	0072		undefined	96	0226	o	
3B	0073		CU3	97	0227	p	
3C	0074		DC4	98	0230	q	
3D	0075		NAK	99	0231	r	
3E	0076		undefined	9A	0232		undefined
3F	0077		SUB	thru	thru		
40	0100	space		A0	0240		

TABLE A-8. FULL EBCDIC CHARACTER SET (Contd)

Hexa- decimal EBCDIC Code	Octal 12-Bit EBCDIC Code	EBCDIC Graphic Character†	EBCDIC Control Character	Hexa- decimal EBCDIC Code	Octal 12-Bit EBCDIC Code	EBCDIC Graphic Character†	EBCDIC Control Character
A1	0241	~		D7	0327	P	
A2	0242	s		D8	0330	Q	
A3	0243	t		D9	0331	R	
A4	0244	u		DA	0332		undefined
A5	0245	v		thru	thru		
A6	0246	w		DF	0337		
A7	0247	x		E0	0340	\	
A8	0250	y		E1	0341		undefined
A9	0251	z		E2	0342	S	
AA	0252		undefined	E3	0343	T	
thru	thru			E4	0344	U	
BF	0277			E5	0345	V	
C0	0300	{		E6	0346	W	
C1	0301	A		E7	0347	X	
C2	0302	B		E8	0350	Y	
C3	0303	C		E9	0351	Z	
C4	0304	D		EA	0352		undefined
C5	0305	E		EB	0353		undefined
C6	0306	F		EC	0354	h	
C7	0307	G		ED	0355		undefined
C8	0310	H		thru	thru		
C9	0311	I		EF	0357		
CA	0312		undefined	F0	0360	0	
CB	0313		undefined	F1	0361	1	
CC	0314	¶		F2	0362	2	
CD	0315	¥	undefined	F3	0363	3	
CE	0316			F4	0364	4	
CF	0317		undefined	F5	0365	5	
D0	0320	}		F6	0366	6	
D1	0321	J		F7	0367	7	
D2	0322	K		F8	0370	8	
D3	0323	L		F9	0371	9	
D4	0324	M		FA	0372		
D5	0325	N		FB	0373		undefined
D6	0326	O		thru	thru		
				FF	0377		

†Graphic characters shown are those used on the IBM System/370 standard (PN) print train. Other devices support subsets or variations of this character graphic set.

## NETWORK ACCESS METHOD

### TERMINAL TRANSMISSION CODE SETS

There are two modes in which coded character data can be exchanged with a network terminal console. These two modes, character mode and transparent mode, correspond to the type of character code editing and translation performed by the network software during input and output operations. The transmission mode used by the network software for input can be selected by the terminal operator, using a Terminal Interface Program command (sometimes referred to as a terminal definition command). The transmission mode used by the network software for output can be selected by the application program providing the terminal facility service.

#### Character Mode Transmissions

Character mode is the initial and default mode used for both input and output transmissions. When the network software services the terminal in character mode, it translates input characters from the transmission code used by the terminal into the ASCII code shown in table A-9. The translation of a specific transmission code to a specific ASCII code depends on the terminal class the network software associates with the terminal. In character mode input, the parity of the terminal transmission code is not preserved in the corresponding ASCII code; the ASCII code received by the terminal-servicing facility program always has its eighth bit set to zero.

Character mode output is translated in a similar manner. The network software provides the parity bit setting appropriate for the terminal being serviced, even though translating from ASCII characters with zero parity bit settings.

Tables A-10 through A-21 show the character mode translations performed for each terminal class. The parity shown in the terminal transmission codes is the parity used as a default for the terminal class. The parity setting actually used by a terminal can be identified to the network software through a TIP command.

Tables A-10 through A-21 contain the graphic and control characters associated with the transmission codes used by the terminal because of the terminal class and code set in use. The network ASCII graphic and control characters shown are those of the standard ASCII character set associated with the ASCII transmission codes of table A-9.

The general case for code translations of character mode data is summarized in the following paragraphs. This generalized description permits use of only table A-9 to explain all specific cases. The reader can logically extend this generalized description to allow use of tables A-1 through A-8 as descriptions of character set mapping for various functions initiated from a terminal. Tables A-1 through A-8 are provided for the reader's use while coding an application program to run under the operating system. They do not describe character transmissions between an application program and the network.

Table A-9 contains the ASCII 128-character set supported by the Network Access Method. A 96-character subset consists of the rightmost six columns and includes the 95-character graphic subset referenced previously in this appendix; the deletion character (DEL) is not a graphic character. A 64-character subset consists of the middle four columns. Note that 6-bit display code equivalents exist for the characters in this 64-character subset only.

Although the network supports the 128-character set, some terminals restrict output to a smaller subset. This restriction is supported by replacing the control characters in columns 0 and 1 of table A-9 with blanks to produce the 96-character subset, and, additionally, replacing the characters in columns 6 and 7 with the corresponding characters from columns 4 and 5, respectively, to produce the 64-character subset.

Similarly, input from a device may be limited to a smaller subset by the device itself because the device cannot produce the full 128-character set. A character input from a device using a character set other than ASCII is converted to an equivalent ASCII character; characters without ASCII character equivalents are replaced by the ASCII blank character.

An application can also cause character replacement (as described previously for output) as well as character conversion, by requesting display-coded input from the network.

The 7-bit hexadecimal code value for each character consists of the character's column number in the table, followed by its row number. For example, N is in row E of column 4, so its value is 4E<sub>16</sub>.

#### Transparent Mode Transmissions

Transparent mode is selected separately for input and output transmissions. During transparent mode input, the parity bit is stripped from each terminal transmission code (unless the N parity option has been selected by a Terminal Interface Program command), and the transmission code is placed in an 8-bit byte without translation to 7-bit ASCII code. Line transmission protocol characters are deleted from a mode 4C terminal input stream.

When the 8-bit bytes arrive in the host computer, a terminal servicing facility program such as the Interactive Facility can right-justify the bytes within a 12-bit byte. Upon transmission of 12-bit bytes from the host computer, the leftmost 4 bits (bits 11 through 8) are discarded.

During transparent mode output, processing similar to that performed for input occurs. The code in each 8-bit byte received by the network software from the terminal servicing facility program is not translated. The parity bit appropriate for the terminal class being used is altered as indicated by the parity option in effect for the terminal. The codes are then output in transmission bytes appropriate for the codes associated with the terminal class being used. Line transmission protocol characters are inserted into a mode 4C terminal output stream.

TABLE A-9. FULL ASCII CHARACTER SET

← 128-Character Set →

← 96-Character Subset →

← 64-Character Subset →

					0	0	0	0	1	1	1	1	
					0	0	1	1	0	0	1	1	
					0	1	2	3	4	5	6	7	
Bits	b <sub>4</sub>	b <sub>3</sub>	b <sub>2</sub>	b <sub>1</sub>	Row	Column							
	0	0	0	0	0	NUL 000	DLE 020	SP 040	0 060	a 100	P 120	· 140	p 160
	0	0	0	1	1	SOH 001	DC1 021	! 041	1 061	A 101	q 121	a 141	q 161
	0	0	1	0	2	STX 002	DC2 022	" 042	2 062	B 102	R 122	b 142	r 162
	0	0	1	1	3	ETX 003	DC3 023	# 043	3 063	C 103	S 123	c 143	s 163
	0	1	0	0	4	EOT 004	DC4 024	\$ 044	4 064	D 104	T 124	d 144	t 164
	0	1	0	1	5	ENQ 005	NAK 025	% 045	5 065	E 105	U 125	e 145	u 165
	0	1	1	0	6	ACK 006	SYN 026	& 046	6 066	F 106	V 126	f 146	v 166
	0	1	1	1	7	BEL 007	ETB 027	' 047	7 067	G 107	W 127	g 147	w 167
	1	0	0	0	8	BS 010	CAN 030	( 050	8 070	H 110	X 130	h 150	x 170
	1	0	0	1	9	HT 011	EM 031	) 051	9 071	I 111	Y 131	i 151	y 171
	1	0	1	0	A	LF 012	SUB 032	* 052	: 072	J 112	Z 132	j 152	z 172
	1	0	1	1	B	VT 013	ESC 033	+ 053	; 073	K 113	[ 133	k 153	{ 173
	1	1	0	0	C	FF 014	FS 034	, 054	< 074	L 114	\ 134	l 154	 174
	1	1	0	1	D	CR 015	GS 035	- 055	= 075	M 115	] 135	m 155	} 175
	1	1	1	0	E	SO 016	RS 036	. 056	> 076	N 116	^ 136	n 156	~ 176
	1	1	1	1	F	SI 017	US 037	/ 057	? 077	O 117	<u>      </u> 137	o 157	DEL 177

LEGEND:

Numbers under characters are the octal values for the 7-bit character codes used within the network.



TABLE A-10. CHARACTER CODE TRANSLATIONS, CONSOLE TERMINAL CLASSES 9, 14, 16, AND 17

Terminal EBCDIC			Network ASCII (Character Mode Use)		
Octal Code	Graphic†	Control Character	Octal Code††	Graphic	Control Character
000		NUL	000		null
001		SOH	001		start of header
002		STX	002		start of text
003		ETX	003		end of text
004		PF	040	space	
005		HT	011		horizontal tabulate
006		LC	040	space	
007		DEL	177		delete
010		undefined	040	space	
011		undefined	040	space	
012		SMM	040	space	
013		VT	013		vertical tabulate
014		FF	014		form feed
015		CR	015		carriage return
016		SO	016		shift out
017		SI	017		shift in
020		DLE	020		data link escape
021		DC1	021		device control 1
022		DC2	022		device control 2
023		TM	023		device control 3
024		RES	040	space	
025		NL	040	space	
026		BS	010		backspace
027		IL	040	space	
030		CAN	030		cancel
031		EM	031		end of medium
032		CC	040	space	
033		CU1	040	space	
034		IFS	034		file separator
035		IGS	035		group separator
036		IRS	036		record separator
037		IUS	037		unit separator
040		DS	040	space	
041		SOS	040	space	
042		FS	040	space	
043		undefined	040	space	
044		BYP	040	space	
045		LF	012		linefeed
046		ETB or EOB	027		end of transmission block
047		ESC or PRE	033		escape
050		undefined	040	space	
051		undefined	040	space	
052		SM	040	space	
053		CU2	040	space	
054		undefined	040	space	
055		ENQ	005		enquiry
056		ACK	006		positive acknowledgment
057		BEL	007		bell
060		undefined	040	space	
061		undefined	040	space	
062		SYN	026		synchronous idle
063		undefined	040	space	
064		PN	040	space	
065		RS	040	space	
066		UC	040	space	
067		EOT	004		end of transmission
070		undefined	040	space	
071		undefined	040	space	
072		undefined	040	space	
073		CU3	040	space	
074		DC4	024		device control 4
075		NAK	025		negative acknowledgement
076		undefined	040	space	
077		SUB	032		substitute
100	space		040	space	

TABLE A-10. CHARACTER CODE TRANSLATIONS, CONSOLE TERMINAL CLASSES 9, 14, 16, AND 17 (Contd)

Terminal EBCDIC			Network ASCII (Character Mode Use)		
Octal Code	Graphic†	Control Character	Octal Code††	Graphic	Control Character
101 thru 111		undefined	040	space	
112	¢		133	[	
113	•		056	•	
114	<		074	<	
115	(		050	(	
116	+		053	+	
117			041	!	
120	&		046	&	
121 thru 131		undefined	040	space	
132	!		135	]	
133	\$		044	\$	
134	*		052	*	
135	)		051	)	
136	;		073	;	
137	⌋		136	^	
140	-		055	-	
141	/		057	/	
142 thru 151		undefined	040	space	
152	!		174	!	
153	,		054	,	
154	%		045	%	
155			137	>	
156	>		076	>	
157	?		077	?	
160 thru 170		undefined	040	space	
171	\		140	\	
172	:		172	:	
173	#		043	#	
174	@		100	@	
175	'		047	'	
176	=		075	=	
177	"		042	"	
200		undefined	040	space	
201	a		141	a	
202	b		142	b	
203	c		143	c	
204	d		144	d	
205	e		145	e	
206	f		146	f	
207	g		147	g	
210	h		150	h	
211	i		151	i	
212 thru 220		undefined	040	space	
221	j		152	j	
222	k		153	k	
223	l		154	l	
224	m		155	m	
225	n		156	n	
226	o		157	o	
227	p		160	p	
230	q		161	q	
231	r		162	r	
232 thru 240		undefined	040	space	

TABLE A-10. CHARACTER CODE TRANSLATIONS, CONSOLE TERMINAL CLASSES 9, 14, 16, AND 17 (Contd)

Terminal EBCDIC			Network ASCII (Character Mode Use)		
Octal Code	Graphic†	Control Character	Octal Code††	Graphic	Control Character
241	~		176	~	
242	s		163	s	
243	t		164	t	
244	u		165	u	
245	v		166	v	
246	w		167	w	
247	x		170	x	
250	y		171	y	
251	z		172	z	
252		undefined	040	space	
thru					
277					
300	}		173	}	
301	A		101	A	
302	B		102	B	
303	C		103	C	
304	D		104	D	
305	E		105	E	
306	F		106	F	
307	G		107	G	
310	H		110	H	
311	I		111	I	
312		undefined	040	space	
313		undefined	040	space	
314	␣		040	space	
315		undefined	040	space	
316	␣		040	space	
317		undefined	040	space	
320	}		175	}	
321	J		112	J	
322	K		113	K	
323	L		114	L	
324	M		115	M	
325	N		116	N	
326	O		117	O	
327	P		120	P	
330	Q		121	Q	
331	R		122	R	
332		undefined	040	space	
thru					
337					
340	\		134	\	
341		undefined	040	space	
342	S		123	S	
343	T		124	T	
344	U		125	U	
345	V		126	V	
346	W		127	W	
347	X		130	X	
350	Y		131	Y	
351	Z		132	Z	
352		undefined	040	space	
353		undefined	040	space	
354	␣		040	space	
355		undefined	040	space	
thru					
357					
360	0		060	0	
361	1		061	1	
362	2		062	2	
363	3		063	3	
364	4		064	4	
365	5		065	5	
366	6		066	6	
367	7		067	7	

TABLE A-10. CHARACTER CODE TRANSLATIONS, CONSOLE TERMINAL CLASSES 9, 14, 16, AND 17 (Contd)

Terminal EBCDIC			Network ASCII (Character Mode Use)		
Octal Code	Graphic <sup>†</sup>	Control Character	Octal Code <sup>††</sup>	Graphic	Control Character
370 371 372 373 thru 377	8 9 	undefined	070 071 040 040	8 9 space space	
<sup>†</sup> Graphic characters shown are those used on the IBM System/370 standard (PN) print train. Other devices support subsets or variations of this character graphic set. <sup>††</sup> Shown with zero parity (eighth or uppermost bit is always zero).					

TABLE A-11. AMERICAN NATIONAL STANDARD CODE FOR INFORMATION INTERCHANGE (ASCII) WITH 029 PUNCHED CARD CODES AND EBCDIC TRANSLATION (BATCH OUTPUT DEVICES, TERMINAL CLASSES 9, 14, 16, AND 17)

ASCII Bit					ASCII Bit															
b <sub>8</sub>	b <sub>7</sub>	b <sub>6</sub>	b <sub>5</sub>		b <sub>8</sub>	b <sub>7</sub>	b <sub>6</sub>	b <sub>5</sub>												
0	0	0	0		0	0	0	0												
1	1	1	1		1	1	1	1												
0	0	0	0		0	0	0	0												
1	1	1	1		1	1	1	1												
b <sub>4</sub>	b <sub>3</sub>	b <sub>2</sub>	b <sub>1</sub>	Col	b <sub>4</sub>	b <sub>3</sub>	b <sub>2</sub>	b <sub>1</sub>	Col											
				Row					Row											
				2					2											
				3					3											
				4					4											
				5					5											
0	0	0	0	0	SP no punch SP	0	0	0	0	@ 8-4 @ 7C	P 11-7 P D7	1	0	0	0	8	( 12-8-5 ( 4D	8 8 8 F8	H 12-8 H C8	X 0-7 X E7
0	0	0	1	1	! 12-8-7 !	1	1	1	1	A 12-1 A C1	Q 11-8 Q D8	1	0	0	1	9	) 11-8-5 ) 5D	9 9 9 F9	I 12-9 I C9	Y 0-8 Y E8
0	0	1	0	2	" 8-7 "	2	2	2	2	B 12-2 B C2	R 11-9 R D9	1	0	1	0	10	* 11-8-4 * 5C	: 8-2 : 7A	J 11-1 J D1	Z 0-9 Z E9
0	0	1	1	3	# 8-3 #	3	3	3	3	C 12-3 C C3	S 0-2 S E2	1	0	1	1	11	+ 12-8-6 + 4E	; 11-8-6 ; 5E	K 11-2 K D2	[ 12-8-2 [ 4A
0	1	0	0	4	\$ 11-8-3 \$	4	4	4	4	D 12-4 D C4	T 0-3 T E3	1	1	0	0	12	, 0-8-3 , 6B	< 12-8-4 < 4C	L 11-3 L D3	\ 0-8-2 \ E0
0	1	0	1	5	% 0-8-4 %	5	5	5	5	E 12-5 E C5	U 0-4 U E4	1	1	0	1	13	- 11 - 60	= 8-6 = 7E	M 11-4 M D4	] 11-8-2 ] 5A
0	1	1	0	6	& 12 &	6	6	6	6	F 12-6 F C6	V 0-5 V E5	1	1	1	0	14	. 12-8-3 . 4B	> 0-8-6 > 6E	N 11-5 N D5	^ 11-8-7 ^ 5F
0	1	1	1	7	' 8-5 '	7	7	7	7	G 12-7 G C7	W 0-6 W E6	1	1	1	1	15	/ 0-1 / 61	? 0-8-7 ? 6F	0 11-6 0 D6	<u>0</u> -8-5 - 6D

LEGEND:

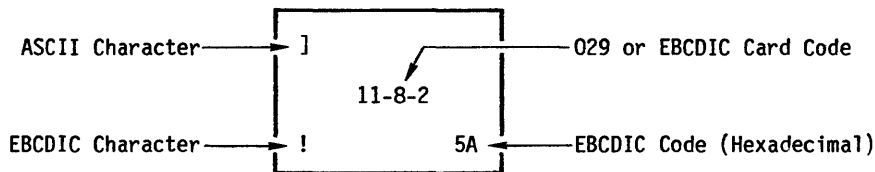
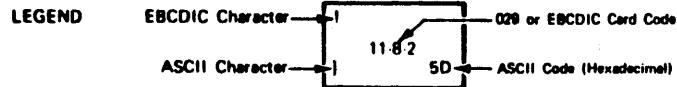

TABLE A-12. EXTENDED BINARY CODED DECIMAL INTERCHANGE CODE (EBCDIC) WITH 029 PUNCHED CARD CODES AND ASCII TRANSLATION (BATCH INPUT DEVICES, TERMINAL CLASSES 9, 14, 16, AND 17)

EBCDIC BITS 8 7 6 5	4 3 2 1	1ST HEX ZND	0	1	2	3	4	5	6	7	8	9	A (10)	B (11)	C (12)	D (13)	E (14)	F (15)
			0000	0	NUL 12-0-9-8-1 SP 20	DLE 12-11-9-8-1 SP 20	DS 11-0-9-8-1 SP 20	12-11-0-9-8-1 SP 20	SP no punch SP 20	A 12 26	11 20	12-11-0 SP 20	12-0-8-1 SP 20	12-11-8-1 SP 20	11-0-8-1 SP 20	12-11-0-8-1 SP 20	12-0 3C	11-0 21
0001	1	SOH 12-9-1 SP 20	DC1 11-9-1 SP 20	SOS 0-9-1 SP 20	9-1 SP 20	12-0-8-1 SP 20	12-11-8-1 SP 20	0-1 2F	12-11-0-8-1 SP 20	12-0-1 A 41	12-11-1 J 4A	11-0-1 ^ 5E	12-11-0-1 SP 20	A 12-1 A 41	J 11-1 J 4A	11-0-8-1 9F	1 1	31
0010	2	STX 12-9-2 SP 20	DC2 11-9-2 SP 20	FS 0-9-2 SP 20	SYN 9-2 SP 20	12-0-8-2 SP 20	12-11-9-2 SP 20	11-0-9-2 SP 20	12-11-0-9-2 SP 20	b 12-0-2 B 42	k 12-11-2 K 4B	l 11-0-2 S 53	12-11-0-2 SP 20	B 12-2 B 42	K 11-2 K 4B	S 0-2 S 53	2 2	32
0011	3	ETX 12-9-3 SP 20	TM 11-9-3 SP 20	0-9-3 SP 20	9-3 SP 20	12-0-9-3 SP 20	12-11-9-3 SP 20	11-0-9-3 SP 20	12-11-0-9-3 SP 20	c 12-0-3 C 43	l 12-11-3 L 4C	t 11-0-3 T 54	12-11-0-3 SP 20	C 12-3 C 43	L 11-3 L 4C	T 0-3 T 54	3 3	33
0100	4	FF 12-9-4 SP 20	RES 11-9-4 SP 20	BYP 0-9-4 SP 20	PN 9-4 SP 20	12-0-9-4 SP 20	12-11-9-4 SP 20	11-0-9-4 SP 20	12-11-0-9-4 SP 20	d 12-0-4 D 44	m 12-11-4 M 4D	u 11-0-4 U 55	12-11-0-4 SP 20	D 12-4 D 44	M 11-4 M 4D	U 0-4 U 55	4 4	34
0101	5	HT 12-9-5 SP 20	NL 11-9-5 SP 20	LF 0-9-5 SP 20	RS 9-5 SP 20	12-0-9-5 SP 20	12-11-9-5 SP 20	11-0-9-5 SP 20	12-11-0-9-5 SP 20	e 12-0-5 E 45	n 12-11-5 N 4E	v 11-0-5 V 56	12-11-0-5 SP 20	E 12-5 E 45	N 11-5 N 4E	V 0-5 V 56	5 5	35
0110	6	LC 12-9-6 SP 20	BS 11-9-6 SP 20	ETB 0-9-6 SP 20	UC 9-6 SP 20	12-0-9-6 SP 20	12-11-9-6 SP 20	11-0-9-6 SP 20	12-11-0-9-6 SP 20	f 12-0-6 F 46	o 12-11-6 O 4F	w 11-0-6 W 57	12-11-0-6 SP 20	F 12-6 F 46	O 11-6 O 4F	W 0-6 W 57	6 6	36
0111	7	DEL 12-9-7 SP 20	IL 11-9-7 SP 20	ESC 0-9-7 SP 20	EOT 9-7 SP 20	12-0-9-7 SP 20	12-11-9-7 SP 20	11-0-9-7 SP 20	12-11-0-9-7 SP 20	g 12-0-7 G 47	p 12-11-7 P 50	x 11-0-7 X 58	12-11-0-7 SP 20	G 12-7 G 47	P 11-7 P 50	X 0-7 X 58	7 7	37
1000	8	GE 12-9-8 SP 20	CAN 11-9-8 SP 20	0-9-8 SP 20	9-8 SP 20	12-0-9-8 SP 20	12-11-9-8 SP 20	11-0-9-8 SP 20	12-11-0-9-8 SP 20	h 12-0-8 H 48	q 12-11-8 Q 51	y 11-0-8 Y 59	12-11-0-8 SP 20	H 12-8 H 48	Q 11-8 Q 51	Y 0-8 Y 59	8 8	38
1001	9	RLF 12-9-8-1 SP 20	EM 11-9-8-1 SP 20	0-9-8-1 SP 20	9-8-1 SP 20	12-8-1 SP 20	11-8-1 SP 20	0-8-1 SP 20	8-1 40	i 12-0-9 I 49	r 12-11-9 R 52	z 11-0-9 Z 5A	12-11-0-9 SP 20	I 12-9 I 49	R 11-9 R 52	Z 0-9 Z 5A	9 9	39
1010	A (10)	SMM 12-9-8-2 SP 20	CC 11-9-8-2 SP 20	SM 0-9-8-2 SP 20	9-8-2 SP 20	12-8-2 5B	11-8-2 5D	0-8-2 5C	8-2 3A	12-0-8-2 SP 20	12-11-8-2 SP 20	11-0-8-2 SP 20	12-11-0-8-2 SP 20	12-0-8-2 SP 20	12-11-8-2 SP 20	11-0-8-2 SP 20	8-2 1(LVM) 12-11-0-8-2 SP 20	20
1011	B (11)	VT 12-9-8-3 SP 20	CU1 11-9-8-3 SP 20	CU2 0-9-8-3 SP 20	CU3 9-8-3 SP 20	12-8-3 2E	11-8-3 24	0-8-3 2C	8-3 23	12-0-8-3 SP 20	12-11-8-3 SP 20	11-0-8-3 SP 20	12-11-0-8-3 SP 20	12-0-8-3 SP 20	12-11-8-3 SP 20	11-0-8-3 SP 20	8-3 SP 20	20
1100	C (12)	FF 12-9-8-4 SP 20	IFS 11-9-8-4 SP 20	0-9-8-4 SP 20	DC4 9-8-4 SP 20	12-8-4 3C	11-8-4 2A	0-8-4 25	8-4 40	12-0-8-4 SP 20	12-11-8-4 SP 20	11-0-8-4 SP 20	12-11-0-8-4 SP 20	12-0-8-4 SP 20	12-11-8-4 SP 20	11-0-8-4 SP 20	8-4 SP 20	20
1101	D (13)	CR 12-9-8-5 SP 20	IGS 11-9-8-5 SP 20	ENQ 0-9-8-5 SP 20	NAK 9-8-5 SP 20	12-8-5 26	11-8-5 29	0-8-5 5F	8-5 27	12-0-8-5 SP 20	12-11-8-5 SP 20	11-0-8-5 SP 20	12-11-0-8-5 SP 20	12-0-8-5 SP 20	12-11-8-5 SP 20	11-0-8-5 SP 20	8-5 SP 20	20
1110	E (14)	SO 12-9-8-6 SP 20	IRS 11-9-8-6 SP 20	ACK 0-9-8-6 SP 20	9-8-6 SP 20	12-8-6 28	11-8-6 3B	0-8-6 3E	8-6 3D	12-0-8-6 SP 20	12-11-8-6 SP 20	11-0-8-6 SP 20	12-11-0-8-6 SP 20	12-0-8-6 SP 20	12-11-8-6 SP 20	11-0-8-6 SP 20	8-6 SP 20	20
1111	F (15)	SI 12-9-8-7 SP 20	IUS 11-9-8-7 SP 20	BEL 0-9-8-7 SP 20	SUB 9-8-7 SP 20	12-8-7 21	11-8-7 5E	0-8-7 3F	8-7 22	12-0-8-7 SP 20	12-11-8-7 SP 20	11-0-8-7 SP 20	12-11-0-8-7 SP 20	12-0-8-7 SP 20	12-11-8-7 SP 20	11-0-8-7 SP 20	8-7 EO 12-11-0-8-7 SP 20	20



NOTE: A card with the character SUB punched in column 1 functions as a /EOR separator card.

TABLE A-13. AMERICAN NATIONAL STANDARD CODE FOR INFORMATION INTERCHANGE (ASCII) WITH 026 PUNCHED CARD CODES AND EBCDIC TRANSLATION (BATCH OUTPUT DEVICES, TERMINAL CLASSES 9, 14, 16, AND 17)

ASCII Bit		b <sub>8</sub> b <sub>7</sub> b <sub>6</sub> b <sub>5</sub>	0 0 1	0 0 1	0 1 0	0 1 0	ASCII Bit	b <sub>8</sub> b <sub>7</sub> b <sub>6</sub> b <sub>5</sub>	0 0 1	0 0 1	0 1 0	0 1 0
b <sub>4</sub> b <sub>3</sub> b <sub>2</sub> b <sub>1</sub>	Col	2	3	4	5	b <sub>4</sub> b <sub>3</sub> b <sub>2</sub> b <sub>1</sub>	Col	2	3	4	5	
Row	Row	2	3	4	5	Row	Row	2	3	4	5	
0 0 0 0	0	SP no punch SP 40	0 0 0 F0	≤ 8-5 ' 7D	P 11-7 P D7	1 0 0 0	8	( 0-8-4 % 6C	8 8 8 F8	H 12-8 H C8	X 0-7 X E7	
0 0 0 1	1	! 12-8-7 ! 4F	1 1 1 F1	A 12-1 A C1	Q 11-8 Q D8	1 0 0 1	9	) 12-8-4 < 4C	9 9 9 F9	I 12-9 I C9	Y 0-8 Y E8	
0 0 1 0	2	# 8-4 @ 7C	2 2 2 F2	B 12-2 B C2	R 11-9 R D9	1 0 1 0	10 (A)	* 11-8-4 * 5C	: 8-2 : 7A	J 11-1 J D1	Z 0-9 Z E9	
0 0 1 1	3	≡ 0-8-6 > 6E	3 3 3 F3	C 12-3 C C3	S 0-2 S E2	1 0 1 1	11 (B)	+ 12 & 50	; 12-8-7 ; 4F	K 11-2 K D2	[ 8-7 " 7F	
0 1 0 0	4	\$ 11-8-3 \$ 5B	4 4 4 F4	D 12-4 D C4	T 0-3 T E3	1 1 0 0	12 (C)	, 0-8-3 , 6B	< 12-0 { C0	L 11-3 L D3	≥ 12-8-5 ( 4D	
0 1 0 1	5	% 8-6 = 7E	5 5 5 F5	E 12-5 E C5	U 0-4 U E4	1 1 0 1	13 (D)	- 11 - 60	= 8-3 # 7B	M 11-4 M D4	] 0-8-2 \ E0	
0 1 1 0	6	^ 0-8-7 ? 6F	6 6 6 F6	F 12-6 F C6	V 0-5 V E5	1 1 1 0	14 (E)	. 12-8-3 . 4B	> 11-8-7 ~ 5F	N 11-5 N D5	⌋ 12-8-6 + 4E	
0 1 1 1	7	↑ 0-8-5 ) 5D	7 7 7 F7	G 12-7 G C7	W 0-6 W E6	1 1 1 1	15 (F)	/ 0-1 / 61	↓ 11-8-6 ; 5E	O 11-6 O D6	→ 0-8-5 - 6D	

LEGEND:

CDC Character → A

EBCDIC Character → A

12-1

← 026 or EBCDIC Card Code

← EBCDIC Code (Hexadecimal) C1

TABLE A-14. CHARACTER CODE TRANSLATIONS, CONSOLE TERMINAL CLASSES 1, 2, AND 5 THROUGH 8

Terminal ASCII (Transparent Mode Use)			Network ASCII (Character Mode Use)		
Octal Code <sup>†</sup>	ASCII Graphic	Control Character <sup>††</sup>	Octal Code <sup>†††</sup>	ASCII Graphic	Control Character
000		NUL or ⓐ	000		null
003	▲	ETX or ⓐ	003		end of text
005		ENQ or WRU or ⓔ	005		enquiry
006		ACK or RU or ⓕ	006		positive acknowledgement
011		HT or ⓘ	011		horizontal tabulate
012		LF or NL or ↓ or ⓙ	012		linefeed
014		FF or FORM or ⓘ	014		formfeed
017	➤	SI or ⓘ	017		shift in

TABLE A-14. CHARACTER CODE TRANSLATIONS, CONSOLE TERMINAL CLASSES 1, 2, AND 5 THROUGH 8 (Contd)

Terminal ASCII (Transparent Mode Use)			Network ASCII (Character Mode Use)		
Octal Code	ASCII Graphic	Control Character††	Octal Code††	ASCII Graphic	Control Character
021		DC1 or X-ON or ⓐ	021		device control 1
022		DC2 or TAPE or ⓑ	022		device control 2
024		DC4 or TAPE or ⓒ	024		device control 4
027		ETB or ⓓ	027		end transmission block
030		CAN or CLEAR or ⓔ	030		cancel
033		ESC or ESCAPE or ⓕ	033		escape
035		GS or ⓖ	035		group separator
036		RS or ⓗ	036		record separator
041	'		041	'	
042	"		042	"	
044	\$		044	\$	
047	'		047	'	
050	(		050	(	
053	+		053	+	
055	-		055	-	
056	.		056	.	
060	0		060	0	
063	3		063	3	
065	5		065	5	
066	6		066	6	
071	9		071	9	
072	:		072	:	
074	<		074	<	
077	?		077	?	
101	A		101	A	
102	B		102	B	
104	D		104	D	
107	G		107	G	
110	H		110	H	
113	K		113	K	
115	M		115	M	
116	N		116	N	
120	P		120	P	
123	S		123	S	
125	U		125	U	
126	V		126	V	
131	Y		131	Y	
132	Z		132	Z	
134	\		134	\	
137	or ←		137	or ←	
140	or ←		140	or ←	
143	c		143	c	
145	e		145	e	
146	f		146	f	
151	i		151	i	
152	j		152	j	
154	l		154	l	
157	o		157	o	
161	q		161	q	
162	r		162	r	
164	t		164	t	
167	w		167	w	
170	x		170	x	
173	or		173	or	
174	or		174	or	
175	or		175	or	
176	or ←		176	or ←	
201		SOH or Ⓐ	001		start of header
202		STX or Ⓑ	002		start of text
204		EOT or Ⓒ	004		end of transmission
207		BELL or Ⓓ	007		bell
210		BS or ← or Ⓔ	010		backspace
213		VT or Ⓕ	013		vertical tabulate
215		CR or RETURN or Ⓜ	015		carriage return



TABLE A-14. CHARACTER CODE TRANSLATIONS, CONSOLE TERMINAL CLASSES 1, 2, AND 5 THROUGH 8 (Contd)

Terminal ASCII (Transparent Mode Use)			Network ASCII (Character Mode Use)		
Octal Code	ASCII Graphic	Control Character <sup>††</sup>	Octal Code <sup>†††</sup>	ASCII Graphic	Control Character
216	◀	SO or $\text{N}$	016		shift out
220		DLE or $\text{P}$	020		data link escape
223		DC3 or X-OFF or $\text{S}$	023		device control 3
225		NAK or $\text{U}$	025		negative acknowledgement
226		SYN or LINE CLEAR or $\text{V}$	026		synchronous idle
231		EM or RESET or $\text{Y}$	031		end of medium
232		SUB or $\text{Z}$	032		substitute
234		FS or $\text{[}$	034		file separator
237		US or $\text{C}$	037		unit separator
240	SPACE or blank		040	space	
243	#		043	#	
245	%		045	%	
246	&		046	&	
251	)		051	)	
252	*		052	*	
254	,		054	,	
257	/		057	/	
261	1		061	1	
262	2		062	2	
264	4		064	4	
267	7		067	7	
270	8		070	8	
273	;		073	;	
275	=		075	=	
276	>		076	>	
300	@		100	@	
303	C		103	C	
305	E		105	E	
306	F		106	F	
311	I		111	I	
312	J		112	J	
314	L		114	L	
317	O		117	O	
321	Q		121	Q	
322	R		122	R	
324	T		124	T	
327	W		127	W	
330	X		130	X	
333	[		133	[	
335	]		135	]	
336	^ or $\text{—}$		136	^	
341	a		141	a	
342	b		142	b	
344	d		144	d	
347	g		147	g	
350	h		150	h	
353	k		153	k	
355	m		155	m	
356	n		156	n	
360	p		160	p	
363	s		163	s	
365	u		165	u	
366	v		166	v	
371	y		171	y	
372	z		172	z	
377	■	DEL or RUBOUT	177		delete

<sup>†</sup>Shown with even parity, which is the default for these terminal classes (unless PA=N, an application program receives the same code as in character mode).

<sup>††</sup>A circle around a character indicates that the character key is pressed in conjunction with a CTL, CTRL, CNTRL, or CONTROL key to generate the code.

<sup>†††</sup>Shown with zero parity (eighth or uppermost bit is always zero).

TABLE A-15. CHARACTER CODE TRANSLATIONS, ASCII TERMINAL CLASSES 10 AND 15

Terminal ASCII <sup>†</sup>					Network ASCII (Character Mode Use)		
Octal Code <sup>††</sup>	Keyboard or Printer Graphic		029 Card Code	026 Card Code	Octal Code <sup>†††</sup>		Graphic
	ASCII	CDC			Input or Output	Console Output Only	
040	blank	Blank	no punch	no punch	040		space
043	#		8-3	0-8-6	043		#
045	%	%	0-8-4	8-6	045		%
046	&		12	0-8-7	046		&
051	)	)	11-8-5	12-8-4	051		)
052	*	*	11-8-4	11-8-4	052		*
054	/	/	0-8-3	0-8-3	054		/
057	/	/	0-1	0-1	057		/
061	1	1	1	1	061		1
062	2	2	2	2	062		2
064	4	4	4	4	064		4
067	7	7	7	7	067		7
070	8	8	8	8	070		8
073	;	;	11-8-6	12-8-7	073		;
075	=	=	8-6	8-3	075		=
076	>	>	0-8-6	11-8-7	076		>
100	@	<	8-4	11-8-5	100	140	@
103	C	C	12-3	12-3	103	143	C
105	E	E	12-5	12-5	105	145	E
106	F	F	12-6	12-6	106	146	F
111	I	I	12-9	12-9	111	151	I
112	J	J	11-1	11-1	112	152	J
114	L	L	11-3	11-3	114	154	L
117	O	O	11-6	11-6	117	157	O
121	Q	Q	11-8	11-8	121	161	Q
122	R	R	11-9	11-9	122	162	R
124	T	T	0-3	0-3	124	164	T
127	W	W	0-6	0-6	127	167	W
130	X	X	0-7	0-7	130	170	X
133	[	[	12-0 or 12-8-2	12-0 or 12-8-3	133	173	[
135	]	]	11-0 or 11-8-2	11-0 or 11-8-2	135	175	]
136	^	^	11-8-7	12-8-6	136	176	^
241	!	!	12-8-7	0-8-2	041		!
242	"	"	8-7	8-4	042		"
244	\$	\$	11-8-3	11-8-3	044		\$
247	'	'	8-5	8-7	047		'
250	(	(	12-8-5	0-8-4	050		(
253	+	+	12-8-6	12	053		+
255	-	-	11	11	055		-
256	.	.	12-8-3	12-8-3	056		.
260	0	0	0	0	060		0
263	3	3	3	3	063		3
265	5	5	5	5	065		5
266	6	6	6	6	066		6
271	9	9	9	9	071		9
272	:	:	8-2	8-2	072		:
274	<	<	12-8-4	8-5	074		<
277	?	?	0-8-7	11-8-6	077		?
301	A	A	12-1	12-1	101	141	A
302	B	B	12-2	12-2	102	142	B
304	D	D	12-4	12-4	104	144	D
307	G	G	12-7	12-7	107	147	G
310	H	H	12-8	12-8	110	150	H
313	K	K	11-2	11-2	113	153	K
315	M	M	11-4	11-4	115	155	M
316	N	N	11-5	11-5	116	156	N
320	P	P	11-7	11-7	120	160	P
323	S	S	0-2	0-2	123	163	S
325	U	U	0-4	0-4	125	165	U

TABLE A-15. CHARACTER CODE TRANSLATIONS, ASCII TERMINAL CLASSES 10 AND 15 (Contd)

Terminal ASCII <sup>†</sup>				Network ASCII (Character Mode Use)			
Octal Code <sup>††</sup>	Keyboard or Printer Graphic		029 Card Code	026 Card Code	Octal Code <sup>†††</sup>		Graphic
	ASCII	CDC			Input or Output	Console Output Only	
326	V	V	0-5	0-5	126	166	V
331	Y	Y	0-8	0-8	131	171	Y
332	Z	Z	0-9	0-9	132	172	Z
334	\	>	0-8-2	12-8-5	134	174	\
337	-	↵	0-8-5	0-8-5	135	177	-

<sup>†</sup>Escape codes and control codes are not listed. These are not treated as network data and have no equivalent character mode translations.

<sup>††</sup>Shown with odd parity, the only possible parity selection for these terminal classes.

<sup>†††</sup>Shown with zero parity (eighth or uppermost bit is always zero). During output, codes 000 through 037<sub>8</sub> are converted to code 040<sub>8</sub> (blank). Codes for lowercase ASCII characters sent to the console are converted to the codes for the equivalent uppercase characters supported by the terminal, as shown; codes for these lowercase characters cannot be sent to batch devices without causing errors.

TABLE A-16. CHARACTER CODE TRANSLATIONS, BCD TERMINAL CLASSES 10 AND 15

Terminal External BCD <sup>†</sup>				Network ASCII (Character Mode Use)			
Octal Code <sup>††</sup>	Keyboard or Printer Graphic		029 Card Code	026 Card Code	Octal Code <sup>†††</sup>		Graphic
	ASCII	CDC			Input or Output	Console Output Only	
020	:	:	8-2	8-2	072		:
040	-	-	11	11	055		-
043	L	L	11-3	11-3	114	154	L
045	N	N	11-5	11-5	116	156	N
046	O	O	11-6	11-6	117	157	O
051	R	R	11-9	11-9	122	162	R
052	!	V	12-8-7	11-0	041		!
054	*	*	11-8-4	11-8-4	052		*
057	>	>	0-8-6	11-8-7	076		>
061	A	A	12-1	12-1	101	141	A
062	B	B	12-2	12-2	102	142	B
064	D	D	12-4	12-4	104	144	D
067	G	G	12-7	12-7	107	147	G
070	H	H	12-8	12-8	108	148	H
073	.	.	12-8-3	12-8-3	056		.
075			12-0	12-8-5	134	174	\
103	3	3	3	3	063		3
105	5	5	5	5	065		5
106	6	6	6	6	066		6
111	9	9	9	9	071		9
112	0	0	0	0	060		0
114	"	=	8-5 or 8-7	8-4	042		"
117	[	[	8-4	8-7	133	173	[
121	/	/	0-1	0-1	057		/
122	S	S	0-2	0-2	123	163	S
124	U	U	0-4	0-4	125	165	U
127	X	X	0-7	0-7	130	170	X
130	Y	Y	0-8	0-8	131	171	Y
133	'	'	0-8-3	0-8-3	054		'
135	-	↵	0-8-5	0-8-5	137	177	-

TABLE A-16. CHARACTER CODE TRANSLATIONS, BCD TERMINAL CLASSES 10 AND 15 (Contd)

Octal Code <sup>††</sup>	Terminal External BCD <sup>†</sup>				Network ASCII (Character Mode Use)		
	Keyboard or Printer Graphic		029 Card Code	026 Card Code	Octal Code <sup>†††</sup>		Graphic
	ASCII	CDC			Input or Output	Console Output Only	
136	#	≡	8-3	0-8-6	043		#
241	J	J	11-1	11-1	112	152	J
242	K	K	11-2	11-2	113	153	K
244	M	M	11-4	11-4	115	155	M
247	P	P	11-7	11-7	120	160	P
250	Q	Q	11-8	11-8	121	161	Q
253	\$	\$	11-8-3	11-8-3	044		\$
255	'	↑	12	11-8-5	047		'
256	?	↓	12-8-7	11-8-6	077		?
263	C	C	12-3	12-3	103	143	C
265	E	E	12-5	12-5	105	145	E
266	F	F	12-6	12-6	106	146	F
271	I	I	12-9	12-9	111	151	I
272	<	<	12-8-4	12-0	074		<
274	)	)	11-8-5	12-8-4	051		)
277	;	;	11-8-6	12-8-7	073		;
301	1	1	1	1	061		1
302	2	2	2	2	062		2
304	4	4	4	4	064		4
307	7	7	7	7	067		7
310	8	8	8	8	070		8
313	=	=	8-6	8-3	075		=
315	a	<	11-8-7	8-5	100	140	a
316	%	%	0-8-4	8-6	045		%
320	blank	blank	no punch	no punch	040		space
323	T	T	0-3	0-3	124	164	T
325	V	V	0-5	0-5	126	166	V
326	W	W	0-6	0-6	127	167	W
331	Z	Z	0-9	0-9	132	172	Z
332	J	J	0-8-2	0-8-2	135	175	J
334	(	(	12-8-5	0-8-4	050		(
337	&	^	0-8-7	0-8-7	046		&
320	^ or blank	␣ or ■ or none	none	none		136, 176	^ §

<sup>†</sup>Escape codes and control codes are not listed. These are not treated as network data and have no equivalent character mode translations.

<sup>††</sup>Shown with odd parity, the only possible parity selection for these terminal classes.

<sup>†††</sup>Shown with zero parity (eighth or uppermost bit is always zero). During output, codes 000 through 037<sub>g</sub> are converted to code 320<sub>g</sub> (blank). Codes for lowercase ASCII characters sent to the console are converted to the codes for the equivalent uppercase characters supported by the terminal, as shown; codes for these lowercase characters cannot be sent to batch devices without causing errors.

<sup>§</sup>Input and output of this symbol is not possible on some terminals. BCD transmission conventions support the rubout symbol ■ as an internal terminal memory parity error indicator instead. The ASCII codes 136<sub>g</sub> and 176<sub>g</sub> are output as a blank.

TABLE A-17. CHARACTER CODE TRANSLATIONS, CONSOLE TERMINAL CLASSES 11, 12, AND 13

Terminal ASCII (Transparent Mode Use)			Network ASCII (Character Mode Use)		
Octal Code†	ASCII Graphic	Control Character††	Octal Code†††	ASCII Graphic	Control Character
001		SOH or (A)	001		start of header
002		STX or (B)	002		start of text
004		EOT or (D)	004		end of transmission
007		BELL or (G)	007		bell
010		BS or ← or (H)	010		backspace
013		VT or (K)	013		vertical tabulate
015		CR or RETURN or (M)	015		carriage return
016		SO or (N)	016		shift out
020		DLE or (P)	020		data link escape
025		NAK or → or (U)	025		negative acknowledgement
026		SYN or LINE CLEAR or (V)	026		synchronous idle
031		EM or RESET or (Y)	031		end of medium
032		SUB or ↑ or (Z)	032		substitute
034		FS or (⊘)	034		file separator
037		US or (⊖)	037		unit separator
040	SPACE or blank		040	space	
043	#		043	#	
045	%		045	%	
046	&		046	&	
051	)		051	)	
052	*		052	*	
054	,		054	,	
057	/		057	/	
061	1		061	1	
062	2		062	2	
064	4		064	4	
067	7		067	7	
070	8		070	8	
073	:		073	:	
075	=		075	=	
076	>		076	>	
100	@		100	@	
103	C		103	C	
105	E		105	E	
106	F		106	F	
111	I		111	I	
112	J		112	J	
114	L		114	L	
117	O		117	O	
121	Q		121	Q	
122	R		122	R	
124	T		124	T	
127	W		127	W	
130	X		130	X	
133	[		133	[	
135	]		135	]	
136	^ or ~		136	^	
141	a		141	a	
142	b		142	b	
144	d		144	d	
147	g		147	g	
150	h		150	h	
153	k		153	k	
155	m		155	m	
156	n		156	n	
160	p		160	p	
163	s		163	s	
165	u		165	u	
166	v		166	v	
171	y		171	y	
172	z		172	z	
177	■	DEL or RUBOUT	177		delete

TABLE A-17. CHARACTER CODE TRANSLATIONS, CONSOLE TERMINAL CLASSES 11, 12, AND 13 (Contd)

Terminal ASCII (Transparent Mode Use)			Network ASCII (Character Mode Use)		
Octal Code†	ASCII Graphic	Control Character††	Octal Code††	ASCII Graphic	Control Character
200		NUL or Ⓚ	000		null
203		ETX or Ⓢ or SEND	003		end of text
205		ENQ or WRU or ⓔ	005		enquiry
206		ACK or RU or ⓕ	006		positive acknowledgement
211		HT or Ⓢ	011		horizontal tabulate
212		LF or NL or ↓ or Ⓤ or NEW LINE	012		linefeed
214		FF or FORM or Ⓛ	014		formfeed
217		SI or Ⓢ	017		shift in
221		DC1 or X-ON or Ⓚ	021		device control 1
222		DC2 or TAPE or Ⓡ	022		device control 2
223		DC3 or X-OFF or Ⓢ	023		device control 3
224		DC4 or TAPE or Ⓣ	024		device control 4
227		ETB or Ⓜ	027		end transmission block
230		CAN or CLEAR or Ⓧ	030		cancel
233		ESC or ESCAPE or Ⓛ	033		escape
235		GS or Ⓢ	035		group separator
236		RS or Ⓢ	036		record separator
241	'		041	'	
242	"		042	"	
244	\$		044	\$	
247	'		047	'	
250	(		050	(	
253	+		053	+	
255	-		055	-	
256	.		056	.	
260	0		060	0	
263	3		063	3	
265	5		065	5	
266	6		066	6	
271	9		071	9	
272	:		072	:	
274	<		074	<	
277	?		077	?	
301	A		101	A	
302	B		102	B	
304	D		104	D	
307	G		107	G	
310	H		110	H	
313	K		113	K	
315	M		115	M	
316	N		116	N	
320	P		120	P	
323	S		123	S	
325	U		125	U	
326	V		126	V	
331	Y		131	Y	
332	Z		132	Z	
334	\		134	\	
337	or ←		137		
340	▽		140	▽	
343	c		143	c	
345	e		145	e	
346	f		146	f	
351	i		151	i	
352	j		152	j	
354	l		154	l	
357	o		157	o	
361	q		161	q	
362	r		162	r	
364	t		164	t	
367	w		167	w	
370	x		170	x	

TABLE A-17. CHARACTER CODE TRANSLATIONS, CONSOLE TERMINAL CLASSES 11, 12, AND 13 (Contd)

Terminal ASCII (Transparent Mode Use)			Network ASCII (Character Mode Use)		
Octal Code†	ASCII Graphic	Control Character††	Octal Code†††	ASCII Graphic	Control Character
373 374 375 376	{   or † or   } ~ or ~		173 174 175 176	{   } ~	

†Shown with odd parity, which is the default for these terminal classes (unless PA=N, an application program receives the same code as in character mode).

††A circle around a character indicates that the character key is pressed in conjunction with a CTL, CTRL, CNTRL, or CONTROL key to generate the code.

†††Shown with zero parity (eighth or uppermost bit is always zero).

TABLE A-18. ASCII CHARACTER CODE TRANSLATIONS, EBCD CONSOLE TERMINAL CLASS 4

Terminal EBCD (Transparent Mode Use)			Network ASCII (Character Mode Use)		
Octal Code†	EBCD Graphic††	Control Character	Octal Code†††	ASCII Graphic	Control Character
000	space		040	space	
001	or -		137 or 055	or -	
002	¢ or @		140 or 100	or @	
003	+ or &		053 or 046	+ or &	
004	* or 8		052 or 070	* or 8	
005	Q or q		121 or 161	Q or q	
006	Y or y		131 or 171	Y or y	
007	H or h		110 or 150	H or h	
010	: or 4		072 or 064	: or 4	
011	M or m		115 or 155	M or m	
012	U or u		125 or 165	U or u	
013	D or d		104 or 144	D or d	
014		PN or PUNCH ON	021		device control 1 (tape on)
015		RES or RESTORE	000		null
016		BY or BYPASS	000		null
017		PF or PUNCH OFF	023		device control 3 (tape off)
020	< or 2		074 or 062	< or 2	
021	K or k		113 or 153	K or k	
022	S or s		123 or 163	S or s	
023	B or b		102 or 142	B or b	
024	) or 0		051 or 060	) or 0	
025		undefined	000		null
026		undefined	000		null
027		undefined	000		null
030	' or 6		041 or 066	' or 6	
031	0 or o		117 or 157	0 or o	
032	W or w		127 or 167	W or w	
033	F or f		106 or 146	F or f	
034		UCS or UPPERCASE	017		shift in <sup>s</sup>
035		BS or BACKSPACE	010		backspace
036		EOB	027		end transmission block <sup>s</sup>
037		LCS or LOWERCASE	016		shift out <sup>s</sup>
040	= or 1		075 or 061	= or 1	
041	J or j		112 or 152	J or j	
042	? or /		077 or 057	? or /	
043	A or a		101 or 141	A or a	
044	( or 9		050 or 071	( or 9	
045	R or r		122 or 162	R or r	
046	Z or z		132 or 172	Z or z	
047	I or i		111 or 151	I or i	

TABLE A-18. ASCII CHARACTER CODE TRANSLATIONS, EBCD CONSOLE TERMINAL CLASS 4 (Contd)

Terminal EBCD (Transparent Mode Use)			Network ASCII (Character Mode Use)		
Octal Code†	EBCD Graphic††	Control Character	Octal Code†††	ASCII Graphic	Control Character
050	% or 5		045 or 065	% or 5	
051	N or n		116 or 156	N or n	
052	V or v		126 or 166	V or v	
053	E or e		105 or 145	E or e	
054		RO or READER STOP	000		null
055		NL or CR or RETURN	015		carriage return
056		LF or LINE FEED	012		line feed
057		HT or TAB	006		horizontal tabulate
060	; or 3		073 or 063	; or 3	
061	L or l		114 or 154	L or l	
062	T or t		124 or 164	T or t	
063	C or c		103 or 143	C or c	
064	" or #		042 or 043	" or #	
065	! or \$		041 or 044	! or \$	
066	or ,		174 or 054	or ,	
067	┘ or .		136 or 056	┘ or .	
070	> or 7		076 or 067	> or 7	
071	P or p		120 or 160	P or p	
072	X or x		130 or 170	X or x	
073	G or g		107 or 147	G or g	
074		EOT	004		end of transmission <sup>§</sup>
075		IL or IDLE or NULL	000		null
076		PRE or PREFIX	001		start of header <sup>§</sup>
077		DEL	177		delete
100	space		040	space	
101	~ or -		137 or 055	~ or -	
102	⌘ or @		140 or 100	⌘ or @	
103	+ or &		053 or 046	+ or &	
104	* or 8		052 or 070	* or 8	
105	Q or q		121 or 161	Q or q	
106	Y or y		131 or 171	Y or y	
107	H or h		110 or 150	H or h	
110	: or 4		072 or 064	: or 4	
111	M or m		115 or 155	M or m	
112	U or u		125 or 165	U or u	
113	D or d		104 or 144	D or d	
114		PN or PUNCH ON	021		device control 1 (tape on)
115		RES or RESTORE	000		null
116		BY or BYPASS	000		null
117		PF or PUNCH OFF	023		device control 3 (tape off)
120	< or 2		074 or 062	< or 2	
121	K or k		113 or 153	K or k	
122	S or s		123 or 163	S or s	
123	B or b		102 or 142	B or b	
124	) or 0		051 or 060	) or 0	
125		undefined	000		null
126		undefined	000		null
127		undefined	000		null
130	' or 6		041 or 066	' or 6	
131	O or o		117 or 157	O or o	
132	W or w		127 or 167	W or w	
133	F or f		106 or 146	F or f	
134		UCS or UPPERCASE	017		shift in <sup>§</sup>
135		BS or BACKSPACE	010		backspace
136		EOB	027		end transmission block <sup>§</sup>
137		LCS or LOWERCASE	016		shift out <sup>§</sup>
140	= or 1		075 or 061	= or 1	
141	J or j		112 or 152	J or j	
142	? or /		077 or 057	? or /	
143	A or a		101 or 141	A or a	
144	( or 9		050 or 071	( or 9	
145	R or r		122 or 162	R or r	
146	Z or z		132 or 172	Z or z	
147	I or i		111 or 151	I or i	



TABLE A-18. ASCII CHARACTER CODE TRANSLATIONS, EBCD CONSOLE TERMINAL CLASS 4 (Contd)

Terminal EBCD (Transparent Mode Use)			Network ASCII (Character Mode Use)		
Octal Code <sup>†</sup>	EBCD Graphic <sup>††</sup>	Control Character	Octal Code <sup>†††</sup>	ASCII Graphic	Control Character
150	% or 5		045 or 065	% or 5	
151	N or n		116 or 156	N or n	
152	V or v		126 or 166	V or v	
153	E or e		105 or 145	E or e	
154		RO or READER STOP	000		null
155		NL or CR or RETURN	015		carriage return
156		LF or LINE FEED	012		line feed
157		HT or TAB	006		horizontal tabulate
160	; or 3		073 or 063	; or 3	
161	L or l		114 or 154	L or l	
162	T or t		124 or 164	T or t	
163	C or c		103 or 143	C or c	
164	" or #		042 or 043	" or #	
165	! or \$		041 or 044	! or \$	
166	or ,		174 or 054	or ,	
167	^ or .		136 or 056	^ or .	
170	> or 7		076 or 067	> or 7	
171	P or p		120 or 160	P or p	
172	X or x		130 or 170	X or x	
173	G or g		107 or 147	G or g	
174		EOT	004		end of transmission <sup>§</sup>
175		IL or IDLE or NULL	000		null
176		PRE or PREFIX	001		start of header <sup>§</sup>
177		DEL	177		delete
000	space <sup>§§</sup>		133 thru	[ or \	
			135	or ]	
000	space <sup>§§</sup>		140	{	
000	space <sup>§§</sup>		173	}	
			175 or 176	or ~	
175		IL or IDLE or NULL <sup>§§</sup>	002		start of text
175		IL or IDLE or NULL <sup>§§</sup>	003		end of text
175		IL or IDLE or NULL <sup>§§</sup>	005		enquire
175		IL or IDLE or NULL <sup>§§</sup>	007		bell
175		IL or IDLE or NULL <sup>§§</sup>	013 or 014		vertical tabulate
					or form feed
175		IL or IDLE or NULL <sup>§§</sup>	020		data link escape
175		IL or IDLE or NULL <sup>§§</sup>	022		device control 2
175		IL or IDLE or NULL <sup>§§</sup>	024 thru		device control 4,
			026		negative acknowledge,
					or synchronize
175		IL or IDLE or NULL <sup>§§</sup>	030 thru		cancel, end of media,
			037		substitute, escape,
					file separator, group
					separator, record
					separator, or unit
					separator

<sup>†</sup>Shown with odd and even parity; odd parity is the default for this terminal class. (Unless PA=N, the application program receives the same code as in character mode.)

<sup>††</sup>Each input line is assumed to begin in lowercase. Input characters are translated to lowercase ASCII characters unless prefixed by the UCS code. Once a case shift occurs, it remains in effect until another case shift code is received, the page width is reached, or the line is transmitted to the host computer. During output, case is preserved by insertion of case shift codes where needed.

<sup>†††</sup>Shown with zero parity (eighth or uppermost bit is always zero).

<sup>§</sup>Not transmitted to the host computer after translation during input.

<sup>§§</sup>Output translation only.

TABLE A-19. APL CHARACTER CODE TRANSLATIONS, EBCD CONSOLE TERMINAL CLASS 4

Terminal EBCD-APL (Transparent Mode Use)			Network ASCII (Character Mode Use)		
Octal Code†	EBCD-APL Graphic††	Control Character	Octal Code†††	ASCII-APL Graphic	Control Character
000	space		040	space	
001	— or +		137 or 053	— or +	
002	→ or ←		161 or 160	→ or ←	
003	+ or X		045 or 146	+ or X	
004	≠ or 8		042 or 070	≠ or 8	
005	? or Q		077 or 121	? or Q	
006	↑ or Y		171 or 131	↑ or Y	
007	△ or H		150 or 110	△ or H	
010	< or 4		100 or 064	< or 4	
011	or M		174 or 115	or M	
012	↓ or U		165 or 125	↓ or U	
013	L or D		144 or 104	L or D	
014		undefined	000		null
015		undefined	000		null
016		undefined	000		null
017		undefined	000		null
020	- or 2		055 or 062	- or 2	
021	⊥ or K		153 or 113	⊥ or K	
022	⌈ or S		163 or 123	⌈ or S	
023	⌊ or B		142 or 102	⌊ or B	
024	⤴ or 0		046 or 060	⤴ or 0	
025		undefined	000		null
026		undefined	000		null
027		undefined	000		null
030	∞ or 6		174 or 066	∞ or 6	
031	∅ or 0		157 or 117	∅ or 0	
032	∞ or W		167 or 127	∞ or W	
033	∞ or F		136 or 106	∞ or F	
034		UCS or UPPERCASE	017		shift in <sup>s</sup>
035		BS or BACKSPACE	010		backspace
036		EOB	027		end transmission block <sup>s</sup>
037		LCS or LOWERCASE	016		shift out <sup>s</sup>
040	" or 1		042 or 061	" or 1	
041	° or J		152 or 112	° or J	
042	\ or /		134 or 057	\ or /	
043	α or A		141 or 101	α or A	
044	∇ or 9		041 or 071	∇ or 9	
045	ρ or R		162 or 122	ρ or R	
046	⊂ or Z		172 or 132	⊂ or Z	
047	∖ or I		151 or 111	∖ or I	
050	= or 5		075 or 065	= or 5	
051	τ or N		156 or 116	τ or N	
052	U or V		166 or 126	U or V	
053	ε or E		145 or 105	ε or E	
054		undefined	000		null
055		NL or CR or RETURN	015		carriage return
056		LF or LINE FEED	012		line feed
057		HT or TAB	006		horizontal tabulate
060	< or 3		074 or 063	< or 3	
061	□ or L		154 or 114	□ or L	
062	~ or T		164 or 124	~ or T	
063	∩ or C		143 or 103	∩ or C	
064	) or ]		051 or 135	) or ]	
065	( or [		050 or 133	( or [	
066	; or ,		073 or 054	; or ,	
067	: or .		072 or 056	: or .	
070	> or 7		076 or 067	> or 7	
071	* or P		052 or 120	* or P	
072	▷ or X		170 or 130	▷ or X	
073	▽ or G		147 or 107	▽ or G	
074		EOT	004		end of transmission <sup>s</sup>
075		IL or IDLE or NULL	000		null

TABLE A-19. APL CHARACTER CODE TRANSLATIONS, EBCD CONSOLE TERMINAL CLASS 4 (Contd)

Terminal EBCD-APL (Transparent Mode Use)			Network ASCII (Character Mode Use)		
Octal Code†	EBCD-APL Graphic††	Control Character	Octal Code†††	ASCII-APL Graphic	Control Character
076		PRE or PREFIX	001		start of header <sup>s</sup>
077		DEL	177		delete
100	space		040	space	
101	— or +		137 or 053	— or +	
102	→ or ←		161 or 160	→ or ←	
103	÷ or X		045 or 146	÷ or X	
104	≠ or 8		042 or 070	≠ or 8	
105	? or Q		077 or 121	? or Q	
106	↑ or Y		171 or 131	↑ or Y	
107	△ or H		150 or 110	△ or H	
110	≤ or 4		100 or 064	≤ or 4	
111	or M		174 or 115	or M	
112	↓ or U		165 or 125	↓ or U	
113	L or D		144 or 104	L or D	
114		undefined	000		null
115		undefined	000		null
116		undefined	000		null
117		undefined	000		null
120	- or 2		055 or 062	- or 2	
121	→ or K		153 or 113	→ or K	
122	↑ or S		163 or 123	↑ or S	
123	⊥ or B		142 or 102	⊥ or B	
124	▲ or 0		046 or 060	▲ or 0	
125		undefined	000		null
126		undefined	000		null
127		undefined	000		null
130	≥ or 6		174 or 066	≥ or 6	
131	≤ or 0		157 or 117	≤ or 0	
132	∞ or W		167 or 127	∞ or W	
133	∞ or F		136 or 106	∞ or F	
134		UCS or UPPERCASE	017		shift in <sup>s</sup>
135		BS or BACKSPACE	010		backspace
136		EOB	027		end transmission block <sup>s</sup>
137		LCS or LOWERCASE	016		shift out <sup>s</sup>
140	" or 1		042 or 061	" or 1	
141	° or J		152 or 112	° or J	
142	\ or /		134 or 057	\ or /	
143	∞ or A		141 or 101	∞ or A	
144	∞ or 9		041 or 071	∞ or 9	
145	p or R		162 or 122	p or R	
146	∞ or Z		172 or 132	∞ or Z	
147	∞ or I		151 or 111	∞ or I	
150	= or 5		075 or 065	= or 5	
151	τ or N		156 or 116	τ or N	
152	U or V		166 or 126	U or V	
153	ε or E		145 or 105	ε or E	
154		undefined	000		null
155		NL or CR or RETURN	015		carriage return
156		LF or LINE FEED	012		line feed
157		HT or TAB	006		horizontal tabulate
160	< or 3		074 or 063	< or 3	
161	□ or L		154 or 114	□ or L	
162	~ or T		164 or 124	~ or T	
163	∞ or C		143 or 103	∞ or C	
164	) or ]		051 or 135	) or ]	
165	( or [		050 or 133	( or [	
166	; or ,		073 or 054	; or ,	
167	: or .		072 or 056	: or .	
170	> or 7		076 or 067	> or 7	
171	* or P		052 or 120	* or P	
172	> or X		170 or 130	> or X	
173	∇ or G		147 or 107	∇ or G	
174		EOT	004		end of transmission <sup>s</sup>

TABLE A-19. APL CHARACTER CODE TRANSLATIONS, EBCD CONSOLE TERMINAL CLASS 4 (Contd)

Terminal EBCD-APL (Transparent Mode Use)			Network ASCII (Character Mode Use)			
Octal Code <sup>†</sup>	EBCD-APL Graphic <sup>††</sup>	Control Character	Octal Code <sup>†††</sup>	ASCII-APL Graphic	Control Character	
175	space <sup>§§</sup>	IL or IDLE or NULL	000	,	null	
176		PRE or PREFIX	001		start of header <sup>§</sup>	
177		DEL	177		delete	
000			047			
000			140			
000			173			
000			175			
175			002			start of text
175			003			end of text
175			005			enquire
175		007		bell		
175		IL or IDLE or NULL <sup>§§</sup>	013 or 014		vertical tabulate	
175		IL or IDLE or NULL <sup>§§</sup>	020 thru		or form feed	
175		IL or IDLE or NULL <sup>§§</sup>	026		data link escape, device	
175		IL or IDLE or NULL <sup>§§</sup>	030 thru		control 1 thru device	
175		IL or IDLE or NULL <sup>§§</sup>	037		control 4,	
175		IL or IDLE or NULL <sup>§§</sup>			negative acknowledge,	
175		IL or IDLE or NULL <sup>§§</sup>			or synchronize	
175		IL or IDLE or NULL <sup>§§</sup>			cancel, end of media,	
175		IL or IDLE or NULL <sup>§§</sup>			substitute, escape,	
175		IL or IDLE or NULL <sup>§§</sup>			file separator, group	
175		IL or IDLE or NULL <sup>§§</sup>			separator, record	
175		IL or IDLE or NULL <sup>§§</sup>			separator, or unit	
175		IL or IDLE or NULL <sup>§§</sup>			separator	

<sup>†</sup>Shown with odd and even parity; odd parity is the default for this terminal class. (Unless PA=N, the application program receives the same code as in character mode.)

<sup>††</sup>Each input line is assumed to begin in lowercase. Input characters are translated to lowercase ASCII characters unless prefixed by the UCS code. Once a case shift occurs, it remains in effect until another case shift code is received, the page width is reached, or the line is transmitted to the host computer. During output, case is preserved by insertion of case shift codes where needed.

<sup>†††</sup>Shown with zero parity (eighth or uppermost bit is always zero).

<sup>§</sup>Not transmitted to the host computer after translation during input.

<sup>§§</sup>Output translation only.

TABLE A-20. ASCII CHARACTER CODE TRANSLATIONS, CORRESPONDENCE CODE CONSOLE TERMINAL CLASS 4

Terminal Correspondence Code (Transparent Mode Use)			Network ASCII (Character Mode Use)		
Octal Code <sup>†</sup>	Correspondence Code Graphic <sup>††</sup>	Control Character	Octal Code <sup>†††</sup>	ASCII Graphic	Control Character
000	space		040	space	
001	¼ or ½		137 or 135	[ or ]	
002	T or t		124 or 164	T or t	
003	J or j		112 or 152	J or j	
004	\$ or 4		044 or 064	\$ or 4	
005	0 or o		117 or 157	0 or o	
006	L or l		114 or 154	L or l	
007	? or /		077 or 057	? or /	
010	% or 5		045 or 065	% or 5	
011	" or '		042 or 041	" or '	
012	E or e		105 or 145	E or e	
013	P or p		120 or 160	P or p	

TABLE A-20. ASCII CHARACTER CODE TRANSLATIONS, CORRESPONDENCE  
CODE CONSOLE TERMINAL CLASS 4 (Contd)

Terminal Correspondence Code (Transparent Mode Use)			Network ASCII (Character Mode Use)		
Octal Code <sup>f</sup>	Correspondence Code Graphic <sup>tt</sup>	Control Character	Octal Code <sup>ttt</sup>	ASCII Graphic	Control Character
014		PN or PUNCH ON	021		device control 1 (tape on)
015		RES or RESTORE	000		null
016		BY or BYPASS	000		null
017		PF or PUNCH OFF	023		device control 3 (tape off)
020	@ or 2		100 or 062	@ or 2	
021	.		056	.	
022	N or n		116 or 156	N or n	
023	+ or =		053 or 075	+ or =	
024	Z or z		132 or 172	Z or z	
025		undefined	000		null
026		undefined	000		null
027		undefined	000		null
030	¢ or 6		041 or 066	! or 6	
031	I or i		111 or 151	I or i	
032	K or k		113 or 153	K or k	
033	Q or q		121 or 161	Q or q	
034		UCS or UPPERCASE	017		shift in <sup>s</sup>
035		BS or BACKSPACE	010		backspace
036		EOB	027		end transmission block <sup>s</sup>
037		LCS or LOWERCASE	016		shift out <sup>s</sup>
040	± or 1		174 or 061	! or 1	
041	M or m		115 or 155	M or m	
042	X or x		130 or 170	X or x	
043	G or g		107 or 147	G or g	
044	) or 0		051 or 060	) or 0	
045	S or s		123 or 163	S or s	
046	H or h		110 or 150	H or h	
047	Y or y		131 or 171	Y or y	
050	& or 7		046 or 067	& or 7	
051	R or r		122 or 162	R or r	
052	D or d		104 or 144	D or d	
053	: or ;		072 or 073	: or ;	
054		RO or READER STOP	000		null
055		NL or CR or RETURN	015		carriage return
056		LF or LINE FEED	012		line feed
057		HT or TAB	006		horizontal tabulate
060	# or 3		043 or 063	# or 3	
061	V or v		126 or 166	V or v	
062	U or u		125 or 165	U or u	
063	F or f		106 or 146	F or f	
064	( or 9		050 or 071	( or 9	
065	W or w		127 or 167	W or w	
066	B or b		102 or 142	B or b	
067	or -		137 or 055	or -	
070	or 8		052 or 070	or 8	
071	A or a		101 or 141	A or a	
072	C or c		103 or 143	C or c	
073	,		054	,	
074		EOT	004		end of transmission <sup>s</sup>
075		IL or IDLE or NULL	000		null
076		PRE or PREFIX	033		escape
077		DEL	177		delete
100	space		040	space	
101	½ or ½		133 or 135	[ or ]	
102	T or t		124 or 164	T or t	
103	J or j		112 or 152	J or j	
104	\$ or 4		044 or 064	\$ or 4	
105	O or o		117 or 157	O or o	
106	L or l		114 or 154	L or l	
107	? or /		077 or 057	? or /	
110	% or 5		045 or 065	% or 5	
111	" or '		042 or 041	" or '	

TABLE A-20. ASCII CHARACTER CODE TRANSLATIONS, CORRESPONDENCE  
CODE CONSOLE TERMINAL CLASS 4 (Contd)

Terminal Correspondence Code (Transparent Mode Use)			Network ASCII (Character Mode Use)		
Octal Code†	Correspondence Code Graphic††	Control Character	Octal Code†††	ASCII Graphic	Control Character
112	E or e		105 or 145	E or e	
113	P or p		120 or 160	P or p	
114		PN or PUNCH ON	021		device control 1 (tape on)
115		RES or RESTORE	000		null
116		BY or BYPASS	000		null
117		PF or PUNCH OFF	023		device control 3 (tape off)
120	@ or 2		100 or 062	@ or 2	
121	.		056	.	
122	N or n		116 or 156	N or n	
123	+ or =		053 or 075	+ or =	
124	Z or z		132 or 172	Z or z	
125		undefined	000		null
126		undefined	000		null
127		undefined	000		null
130	¢ or 6		041 or 066	! or 6	
131	I or i		111 or 151	I or i	
132	K or k		113 or 153	K or k	
133	Q or q		121 or 161	Q or q	
134		UCS or UPPERCASE	017		shift in <sup>§</sup>
135		BS or BACKSPACE	010		backspace
136		EOB	027		end transmission block <sup>§</sup>
137		LCS or LOWERCASE	016		shift out <sup>§</sup>
140	± or 1		174 or 061	± or 1	
141	M or m		115 or 155	M or m	
142	X or x		130 or 170	X or x	
143	G or g		107 or 147	G or g	
144	) or 0		051 or 060	) or 0	
145	S or s		123 or 163	S or s	
146	H or h		110 or 150	H or h	
147	Y or y		131 or 171	Y or y	
150	& or 7		046 or 067	& or 7	
151	R or r		122 or 162	R or r	
152	D or d		104 or 144	D or d	
153	: or ;		072 or 073	: or ;	
154		RO or READER STOP	000		null
155		NL or CR or RETURN	015		carriage return
156		LF or LINE FEED	012		line feed
157		HT or TAB	006		horizontal tabulate
160	# or 3		043 or 063	# or 3	
161	V or v		126 or 166	V or v	
162	U or u		125 or 165	U or u	
163	F or f		106 or 146	F or f	
164	( or 9		050 or 071	( or 9	
165	W or w		127 or 167	W or w	
166	B or b		102 or 142	B or b	
167	_ or -		137 or 055	_ or -	
170	* or 8		052 or 070	* or 8	
171	A or a		101 or 141	A or a	
172	C or c		103 or 143	C or c	
173	,		054	,	
174		EOT	004		end of transmission <sup>§</sup>
175		IL or IDLE or NULL	000		null
176		PRE or PREFIX	033		escape
177		DEL	177		delete
000	space <sup>§§</sup>		047		
000	space <sup>§§</sup>		134		
000	space <sup>§§</sup>		136		
000	space <sup>§§</sup>		140		
000	space <sup>§§</sup>		173		
000	space <sup>§§</sup>		175 or 176		
175		IL or IDLE or NULL <sup>§§</sup>	001		start of header
175		IL or IDLE or NULL <sup>§§</sup>	002		start of text

TABLE A-20. ASCII CHARACTER CODE TRANSLATIONS, CORRESPONDENCE  
CODE CONSOLE TERMINAL CLASS 4 (Contd)

Terminal Correspondence Code (Transparent Mode Use)			Network ASCII (Character Mode Use)		
Octal Code <sup>†</sup>	Correspondence Code Graphic <sup>††</sup>	Control Character	Octal Code <sup>†††</sup>	ASCII Graphic	Control Character
175		IL or IDLE or NULL <sup>§§</sup>	003		end of text
175		IL or IDLE or NULL <sup>§§</sup>	005		enquire
175		IL or IDLE or NULL <sup>§§</sup>	007		bell
175		IL or IDLE or NULL <sup>§§</sup>	013 or 014		vertical tabulate or form feed
175		IL or IDLE or NULL <sup>§§</sup>	020		data link escape
175		IL or IDLE or NULL <sup>§§</sup>	022		device control 2
175		IL or IDLE or NULL <sup>§§</sup>	024 thru 026		device control 4, negative acknowledge, or synchronize
175		IL or IDLE or NULL <sup>§§</sup>	030 thru 037		cancel, end of media, substitute, file separator, group separator, record separator, or unit separator

<sup>†</sup>Shown with odd and even parity; odd parity is the default for this terminal class. (Unless PA=N, the application program receives the same code as in character mode.)

<sup>††</sup>Each input line is assumed to begin in lowercase. Input characters are translated to lowercase ASCII characters unless prefixed by the UCS code. Once a case shift occurs, it remains in effect until another case shift code is received, the page width is reached, or the line is transmitted to the host computer. During output, case is preserved by insertion of case shift codes where needed.

<sup>†††</sup>Shown with zero parity (eighth or uppermost bit is always zero).

<sup>§</sup>Not transmitted to the host computer after translation during input.

<sup>§§</sup>Output translation only.

TABLE A-21. APL CHARACTER CODE TRANSLATIONS, CORRESPONDENCE  
CODE CONSOLE TERMINAL CLASS 4

Terminal Correspondence Code (Transparent Mode Use)			Network ASCII (Character Mode Use)		
Octal Code <sup>†</sup>	Correspondence Code APL Graphic <sup>††</sup>	Control Character	Octal Code <sup>†††</sup>	ASCII-APL Graphic	Control Character
000	space		040	space	
001	→ or ←		161 or 160	→ or ←	
002	~ or T		164 or 124	~ or T	
003	. or J		056 or 112	. or J	
004	≤ or 4		100 or 064	≤ or 4	
005	o or 0		157 or 117	o or 0	
006	□ or L		154 or 114	□ or L	
007	\ or /		134 or 057	\ or /	
010	= or 5		075 or 065	= or 5	
011	) or ]		051 or 035	) or ]	
012	ε or E		145 or 105	ε or E	
013	* or P		052 or 120	* or P	
014		undefined	000		null
015		undefined	000		null
016		undefined	000		null
017		undefined	023		null
020	— or 2		136 or 062	— or 2	
021	: or .		072 or 056	: or .	
022	τ or N		156 or 116	τ or N	

TABLE A-21. APL CHARACTER CODE TRANSLATIONS, CORRESPONDENCE  
CODE CONSOLE TERMINAL CLASS 4 (Contd)

Terminal Correspondence Code (Transparent Mode Use)			Network ASCII (Character Mode Use)		
Octal Code†	Correspondence Code APL Graphic††	Control Character	Octal Code†††	ASCII-APL Graphic	Control Character
023	+ or X		045 or 146	+ or X	
024	< or Z		172 or 132	< or Z	
025		undefined	000		null
026		undefined	000		null
027		undefined	000		null
030	> or 6		174 or 066	> or 6	
031	\ or I		151 or 111	\ or I	
032	or K		153 or 113	or K	
033	? or Q		077 or 121	? or Q	
034		UCS or UPPERCASE	017		shift in <sup>s</sup>
035		BS or BACKSPACE	010		backspace
036		EOB	027		end transmission block <sup>s</sup>
037		LCS or LOWERCASE	016		shift out <sup>s</sup>
040	" or 1		042 or 061	" or 1	
041	or M		174 or 115	or M	
042	> or X		170 or 130	> or X	
043	∇ or G		147 or 107	∇ or G	
044	^ or O		045 or 060	^ or O	
045	⌈ or S		163 or 123	⌈ or S	
046	△ or H		150 or 110	△ or H	
047	↑ or Y		171 or 131	↑ or Y	
050	> or 7		076 or 067	> or 7	
051	p or R		162 or 122	p or R	
052	⌊ or D		144 or 104	⌊ or D	
053	( or [		050 or 133	( or [	
054		undefined	000		null
055		NL or CR or RETURN	015		carriage return
056		LF or LINE FEED	012		line feed
057		HT or TAB	006		horizontal tabulate
060	< or 3		074 or 063	< or 3	
061	U or V		166 or 126	U or V	
062	↓ or U		165 or 125	↓ or U	
063	or F		137 or 106	or F	
064	↙ or 9		041 or 071	↙ or 9	
065	ε or W		167 or 127	ε or W	
066	⊥ or B		142 or 102	⊥ or B	
067	- or +		055 or 053	- or +	
070	≠ or 8		042 or 070	≠ or 8	
071	α or A		141 or 101	α or A	
072	∅ or C		143 or 103	∅ or C	
073	; or ,		073 or 054	; or ,	
074		EOT	004		end of transmission <sup>s</sup>
075		IL or IDLE or NULL	000		null
076		PRE or PREFIX	033		escape
077		DEL	177		delete
100	space		040	space	
101	→ or ←		161 or 160	→ or ←	
102	~ or T		164 or 124	~ or T	
103	. or J		056 or 112	. or J	
104	≤ or 4		100 or 064	≤ or 4	
105	0 or 0		157 or 117	0 or 0	
106	□ or L		154 or 114	□ or L	
107	\ or /		134 or 057	\ or /	
110	= or 5		075 or 065	= or 5	
111	) or ]		051 or 035	) or ]	
112	ε or E		145 or 105	ε or E	
113	* or P		052 or 120	* or P	
114		undefined	000		null
115		undefined	000		null
116		undefined	000		null
117		undefined	023		null
120	— or 2		136 or 062	— or 2	



TABLE A-21. APL CHARACTER CODE TRANSLATIONS, CORRESPONDENCE  
CODE CONSOLE TERMINAL CLASS 4 (Contd)

Terminal Correspondence Code (Transparent Mode Use)			Network ASCII (Character Mode Use)		
Octal Code†	Correspondence Code APL Graphic††	Control Character	Octal Code†††	ASCII-APL Graphic	Control Character
121	: or .		072 or 056	: or .	
122	τ or N		156 or 116	τ or N	
123	+ or X		045 or 146	+ or X	
124	c or Z		172 or 132	c or Z	
125		undefined	000		null
126		undefined	000		null
127		undefined	000		null
130	≥ or 6		174 or 066	≥ or 6	
131	∖ or I		151 or 111	∖ or I	
132	⊥ or K		153 or 113	⊥ or K	
133	? or Q		077 or 121	? or Q	
134		UCS or UPPERCASE	017		shift in <sup>s</sup>
135		BS or BACKSPACE	010		backspace
136		EOB	027		end transmission block <sup>s</sup>
137		LCS or LOWERCASE	016		shift out <sup>s</sup>
140	" or 1		042 or 061	" or 1	
141	or M		174 or 115	or M	
142	∩ or X		170 or 130	∩ or X	
143	∇ or G		147 or 107	∇ or G	
144	⋈ or O		045 or 060	⋈ or O	
145	⌈ or S		163 or 123	⌈ or S	
146	Δ or H		150 or 110	Δ or H	
147	† or Y		171 or 131	† or Y	
150	> or 7		076 or 067	> or 7	
151	ρ or R		162 or 122	ρ or R	
152	⌊ or D		144 or 104	⌊ or D	
153	( or [		050 or 133	( or [	
154		undefined	000		null
155		NL or CR or RETURN	015		carriage return
156		LF or LINE FEED	012		line feed
157		HT or TAB	006		horizontal tabulate
160	< or 3		074 or 063	< or 3	
161	U or V		166 or 126	U or V	
162	↓ or U		165 or 125	↓ or U	
163	⌋ or F		137 or 106	⌋ or F	
164	∨ or 9		041 or 071	∨ or 9	
165	ω or W		167 or 127	ω or W	
166	⊥ or B		142 or 102	⊥ or B	
167	- or +		055 or 053	- or +	
170	≠ or 8		042 or 070	≠ or 8	
171	α or A		141 or 101	α or A	
172	∏ or C		143 or 103	∏ or C	
173	; or ,		073 or 054	; or ,	
174		EOT	004		end of transmission <sup>s</sup>
175		IL or IDLE or NULL	000		null
176		PRE or PREFIX	033		escape
177		DEL	177		delete
000	space <sup>§§</sup>		047		
000	space <sup>§§</sup>		140	◇	
000	space <sup>§§</sup>		173	⋮	
000	space <sup>§§</sup>		175 or 176	⋮ or ⋮	
175		IL or IDLE or NULL <sup>§§</sup>	001		start of header
175		IL or IDLE or NULL <sup>§§</sup>	002		start of text
175		IL or IDLE or NULL <sup>§§</sup>	003		end of text
175		IL or IDLE or NULL <sup>§§</sup>	005		enquire
175		IL or IDLE or NULL <sup>§§</sup>	007		bell
175		IL or IDLE or NULL <sup>§§</sup>	013 or 014		vertical tabulate or form feed
175		IL or IDLE or NULL <sup>§§</sup>	020		data link escape
175		IL or IDLE or NULL <sup>§§</sup>	022		device control 2

TABLE A-21. APL CHARACTER CODE TRANSLATIONS, CORRESPONDENCE  
CODE CONSOLE TERMINAL CLASS 4 (Contd)

Terminal Correspondence Code (Transparent Mode Use)			Network ASCII (Character Mode Use)		
Octal Code <sup>†</sup>	Correspondence Code APL Graphic <sup>††</sup>	Control Character	Octal Code <sup>†††</sup>	ASCII-APL Graphic	Control Character
175		IL or IDLE or NULL <sup>§§</sup>	024 thru 026		device control 4, negative acknowledge, or synchronize cancel, end of media, substitute, file separator, group separator, record separator, or unit separator
175		IL or IDLE or NULL <sup>§§</sup>	030 thru 037		

<sup>†</sup>Shown with odd and even parity; odd parity is the default for this terminal class. (Unless PA=N, the application program receives the same code as in character mode.)

<sup>††</sup>Each input line is assumed to begin in lowercase. Input characters are translated to lowercase ASCII characters unless prefixed by the UCS code. Once a case shift occurs, it remains in effect until another case shift code is received, the page width is reached, or the line is transmitted to the host computer. During output, case is preserved by insertion of case shift codes where needed.

<sup>†††</sup>Shown with zero parity (eighth or uppermost bit is always zero).

<sup>§</sup>Not transmitted to the host computer after translation during input.

<sup>§§</sup>Output translation only.

Four types of in-line diagnostics are available for CCP.

- Halt messages. These are delivered to the NPU console when the NPU stops. Normally the NPU contents are dumped to the host prior to restarting. These dumps are processed into a dump listing by the host's Network Dump Analyzer (NDA).
- Alarm messages. These are delivered to the network operator's (NOP) console. These alarm messages alert the NOP to check the recent performance of the NPU and the NPU's controlled devices (including terminals). This performance is recorded on the host's engineering file by CE error messages and statistics messages.

NOTE

If the user has elected to purchase a network maintenance contract the contents of the engineering file can be easily analyzed by the Hardware Performance Analyzer (HPA). Otherwise the user must devise his own method for making the host's engineering file contents available.

- CE error messages. These messages which reflect hardware errors are delivered to the host's engineering file. The messages should be processed by the HPA or the user's analysis program.
- Statistics messages. These messages which reflect hardware performance (normal or erroneous) are delivered to the host's engineering file. The messages should be processed by the HPA or the user's analysis program.

ALARM MESSAGES

Alarm messages and the appropriate actions to take in responding to the messages are described in table B-1.

NOTE

If the user has not elected to purchase a maintenance contract for CCP, the NOP should devise a system for dumping the engineering day file in the host, and for analyzing NPU error messages in that file.

TABLE B-1. ALARM MESSAGES

Message	Action
From NPU ii/resident MAINTENANCE ALARM COUPLER	Find coupler error codes in host day file
From NPU ii/resident MAINTENANCE ALARM MLIA	Find MLIA error codes in host day file
From NPU ii/resident MAINTENANCE ALARM PORT jj	Find CLA, modem messages in host day file

CE ERROR MESSAGES

CE error messages can be divided into five categories as follows:

- Modem signal messages (error codes 01 through 03, 0B and 0C)
- CLA messages (error codes 04 through 0A and 0D through 10)
- MLIA messages (error code 11)
- Coupler messages (error codes 20 through 24 and 26 through 29)
- TIP or LIP related messages (2A through 37).

All other codes are unused. These messages are described in tables B-2 and B-3.

STATISTICS MESSAGE

Refer to table B-4 for statistics message text definition.

HALT CODE MESSAGES AND DUMP INTERPRETATION

When the CCP stops the NPU because of an unrecoverable condition caused by either hardware or software errors, the CCP delivers a halt message to the NOP console. See table B-5. This information is also included in the NPU dump. Format of the halt message is:

```
HALT xxxxx yyyy
      wwww PORT
      zzzz BUFFER ADDR
```

- xxxxx is the address of the program in control at the time when the halt condition occurred or information relating to the halt code.
- yyyy is the halt code (hexadecimal format)
- wwww appears only on CLA address out of range (0005) and CLA status overflow (000D) codes
- zzzz appears only on buffer halt codes (000A, 000B, 000C)

TABLE B-2. CE ERROR CODES

Code (Hexadecimal)	Significance	Action
01	Not used	None.
02	Abnormal data set ready (DSR) or clear to send (CTS)	None. This is not an error. It occurs as part of the normal disconnect sequence on some lines.
03	Abnormal data carrier detect ( $\overline{\text{DCD}}$ )	If this occurs occasionally, ignore it. Otherwise, call a CE or analyst.
04	Unsolicited output data demand (ODD)	Check for CLA duplicate address or CLA address switch set between two numbers. This error should not cause concern unless it occurs frequently; if it occurs frequently, call a CE or analyst.
05	CLA address out of range	Same as code 04
06	Illegal mux loop cell format	Same as code 03
07	Unsolicited input	Same as code 04
08	Input mux loop error	Same as code 03
09	Output mux loop error	Same as code 03
0A	TIP event receiver timeout for ODD	Same as code 03
0B	TIP event receiver timeout for DCD	Same as code 03
0C	Abnormal secondary data carrier detect (SDCD)	This is normal for channels using reverse channel interrupts. For other channels, call a CE or analyst.
0D	Excessive CLA status messages	If this occurs frequently, call a CE or analyst.
0E	Not used	None.
0F	Next character not available (output)	Put CLAs in proper priority positions so higher speed or high-use channels are serviced first. If this does not solve problem, call a CE or analyst.
10	Data transfer overrun (input)	Same as code 0F
11	MLIA error status	Same as code 03
12 thru 1F	Not used	None. The CE error code part of the CE message is evidently garbled.
20	Deadman timeout	None. This can occur normally due to the host locking out the 255x due to host processing higher priority batch tasks.
21	Spurious coupler interrupt	This will occur occasionally. If frequent occurrence, call a CE or analyst.
22	Not used	Same as code 12

TABLE B-2. CE ERROR CODES (Contd)

Code (Hexadecimal)	Significance	Action
23	Coupler hardware timeout on input	Same as code 03
24	Input data transfer terminated by PPU	Same as code 03
25	Not used	Same as code 12
26	Not used	Same as code 12
27	Output data transfer terminated by PPU	Same as code 03
28	Hardware timeout on output	Same as code 03
29	End of operation (EOP) missing	Same as code 03
2A	HASP TIP: Too many NAKs received	Same as code 03
2B	HASP TIP: Bad BCB from HASP TIP	Same as code 03
2C	HASP TIP: Bad BCB from HASP workstation	Same as code 03
2D	HASP TIP: Workstation restart	Not an error if workstation is restarting. Otherwise, call CE or analyst.
2E	Mode 4 TIP: Card slip error	Notify person responsible for maintaining the terminal. Call CE or analyst.
2F	Mode 4 TIP: Auto recognition failed	If port shows unusually low volume of traffic, someone may have called wrong number. Otherwise, call CE or analyst.
30	Mode 4 TIP: No response from terminal	Contact terminal operator; have him verify that terminal is properly configured with all switches in correct position. Then call CE or analyst.
31	Mode 4 TIP: Bad response (unexpected response)	Same as code 30
32	Mode 4 TIP: Error response from terminal	Same as code 30
33	LIP: Timeout on idle block	Same as code 03
34	LIP: Protocol failure (no response to frame)	Same as code 03
35	LIP: Remote NPU rejected command from local NPU	Same as code 03
36	LIP: Bad frame detected by CRC	An occasional bad frame is normal. If bad frames occur frequently, call CE or analyst.
37	ASYNC TIP: Parity errors	Check for mismatch in parity between terminal and CCP. If not mismatch, check CLA. Call a CE or analyst.



TABLE B-3. CE ERROR MESSAGE TEXT DEFINITIONS (Contd)

Error Codes (Hexadecimal)	Text Definition
21 thru 24	<div style="text-align: center; border: 1px solid black; padding: 2px;">CP ST</div> <p>where: CP and ST Coupler status word</p>
27 thru 29	<div style="text-align: center; border: 1px solid black; padding: 2px;">CP ST</div> <p>where: CP and ST Coupler status word</p>
2A thru 2D	<div style="text-align: center; border: 1px solid black; padding: 2px;">P 00</div> <p>where: P Port number (CLA address)</p>
2E thru 32	<div style="text-align: center; border: 1px solid black; padding: 2px;">P 00 CA TA DT ERR</div> <p>where: P Port number (CLA address) CA Cluster address TA Terminal address DT Device type ERR Error count (not used on message number 37)</p>
33 thru 36	<div style="text-align: center; border: 1px solid black; padding: 2px;">P 00 NID</div> <p>where: P Port number (CLA address) NID Node ID of remote NPU</p>
37	<div style="text-align: center; border: 1px solid black; padding: 2px;">P 00 CA TA DT TC</div> <p>where: P Port number (CLA address) CA Cluster address TA Terminal address DT Device type TC Terminal class</p>
<p><b>Coupler Status Word (CP and ST)</b></p> <div style="text-align: center; margin-bottom: 10px;"> <span style="margin-right: 10px;">15</span> <span style="margin-right: 10px;">14</span> <span style="margin-right: 10px;">13</span> <span style="margin-right: 10px;">12</span> <span style="margin-right: 10px;">11</span> <span style="margin-right: 10px;">10</span> <span style="margin-right: 10px;">9</span> <span style="margin-right: 10px;">8</span> <span style="margin-right: 10px;">7</span> <span style="margin-right: 10px;">6</span> <span style="margin-right: 10px;">5</span> <span style="margin-right: 10px;">4</span> <span style="margin-right: 10px;">3</span> <span style="margin-right: 10px;">2</span> <span style="margin-right: 10px;">1</span> <span>0</span> </div> <div style="display: flex; justify-content: space-between; align-items: center;"> <div style="width: 45%;"> <p>Alarm ———</p> <p>Chain address zero ———</p> <p>Not used ———</p> <p>CYBER channel parity error ———</p> <p>Hardware timeout ———</p> <p>NPU status accepted ———</p> <p>Orderword loaded ———</p> </div> <div style="width: 10%; text-align: center;"> </div> <div style="width: 45%; text-align: right;"> <p>Memory parity error ———</p> <p>Memory protect fault ———</p> <p>NPU status register loaded ———</p> <p>Memory address register loaded ———</p> <p>External cabinet alarm ———</p> <p>Transmission complete ———</p> <p>Transfer terminated by NPU ———</p> <p>Transfer terminated by PPU ———</p> </div> </div>	

TABLE B-4. STATISTICS MESSAGE TEXT DEFINITIONS

Secondary Function Code	Text Definition													
01	<p><b>NPU STATISTICS</b></p> <table border="1" data-bbox="448 394 1019 457"> <tr> <td>1</td><td>2</td><td>3</td><td>4</td><td>5</td><td>6</td><td>7</td><td>8</td><td>9</td><td>10</td><td>11</td> </tr> </table> <p style="text-align: right;">Statistics Words</p> <p>where: Word 1 Service messages generated            Word 2 Service messages processed            Word 3 Bad service messages received            Word 4 Blocks discarded due to bad address            Word 5 Packets/blocks discarded due to bad format            Word 6 Times at no regulation            Word 7 Times at regulation Level 3            Word 8 Times at regulation Level 2            Word 9 Times at regulation Level 1            Word 10 Times at regulation Level 0            Word 11 Packet protocol timeouts</p> <p>NOTE: Each word is composed of two bytes.</p>	1	2	3	4	5	6	7	8	9	10	11		
1	2	3	4	5	6	7	8	9	10	11				
02	<p><b>TRUNK/LINE STATISTICS</b></p> <table border="1" data-bbox="448 909 1013 978"> <tr> <td>P</td><td>00</td><td>HO</td><td>LRN</td><td>Word 1</td><td>Word 2</td><td>Word 3</td><td>Word 4</td> </tr> </table> <p>where: P Port            HO Host ordinal            LRN Link remote node - ID of NPU at opposite end of trunk (always 0 for lines)</p> <p>Trunk/line statistics words (2 bytes each)</p> <p>Word 1 Number of blocks transmitted            Word 2 Number of blocks received            Word 3 Number of characters transmitted in good blocks            Word 4 Number of characters received in good blocks</p>	P	00	HO	LRN	Word 1	Word 2	Word 3	Word 4					
P	00	HO	LRN	Word 1	Word 2	Word 3	Word 4							
03	<p><b>TERMINAL STATISTICS</b></p> <table border="1" data-bbox="448 1381 1109 1455"> <tr> <td>P</td><td>00</td><td>HO</td><td>CA</td><td>TA</td><td>DT</td><td>HO</td><td>Word 1</td><td>Word 2</td><td>Word 3</td> </tr> </table> <p>where: P Port            HO Host ordinal            CA Cluster address            TA Terminal address            DT Device type (see below)</p> <p>Terminal statistics words (2 bytes each)</p> <p>Word 1 Number of good blocks transmitted            Word 2 Number of good blocks received            Word 3 Number of bad blocks</p> <p>bit 7 5 4 0</p> <table border="1" data-bbox="453 1812 782 1885"> <tr> <td>DT =</td> <td>Device</td> <td>Terminal Class</td> </tr> </table> <p>Device type - byte 13</p>	P	00	HO	CA	TA	DT	HO	Word 1	Word 2	Word 3	DT =	Device	Terminal Class
P	00	HO	CA	TA	DT	HO	Word 1	Word 2	Word 3					
DT =	Device	Terminal Class												



TABLE B-4. STATISTICS MESSAGE TEXT DEFINITIONS (Contd)

Secondary Function Code	Text Definition					
03	TERMINAL STATISTICS (Contd)					
	Class	0 Console	1 Card Reader	Device 2 Line Printer	3 Card Punch	4 Plotter
	1	M33, etc.				
	2	713				
	4	2741				
	5	M40				
	6	H2000				
	7	751-1				
	8	T4014				
	9	HASP (postprint)	HASP (postprint)	HASP (postprint)	HASP (postprint)	HASP (postprint)
	10	200UT	200UT	200UT		
	11	714X		714X		
	12	711-10				
	13	714		714		
	14	HASP (preprint)	HASP (preprint)	HASP (preprint)	HASP (preprint)	HASP (preprint)
	15	734				
	16	2780	2780	2780	2780	
	17	3780	3780	3780	3780	
	Device = 5 reserved for internal host/NPU use = 6 reserved for expansion = 7 reserved for installations Terminal Class = 18-27 reserved for expansion = 28-31 reserved for installations					

When such a halt occurs, the host normally executes an upline dump of the NPU main memory, micromemory, and the file 1 registers. Thereafter, the host attempts to reload the NPU main memory. This is accomplished directly through the coupler for local NPUs; it is accomplished by use of overlays in the local NPU connected to the remote NPU in the case of a remote NPU.

For the first two loading attempts, a dump is normally taken. Thereafter, dumps are suppressed.

The NPU can be stopped locally by master clearing it using the MASTER CLEAR switch on the maintenance control panel.

TABLE B-5. HALT CODES

Code (Hexadecimal)	Significance	Action
0001	Power failure	Reapply power, reload CCP (for momentary failure). Call CE or analyst.
0002	Memory parity error	Call CE or analyst.
0003	Program protect error	Check that software breakpoint not accidentally left set. Call CE or analyst.
0004	Interrupt count <0	Same as code 0002
0005	MLIA failure (reported by MLIA hardware status)	Same as code 0002
0006	Overran CIB	Same as code 0002
0007	Branch to zero detected	Same as code 0002
0008	Invalid halt code	Same as code 0002
0009	Ran out of buffers	Check installation handbook to find if sufficient mem- ory available to handle system configuration. Call CE or analyst.
000A	Duplicate release of buffer	Same as code 0002
000B	Buffer chain error during buffer get	Same as code 0002
000C	Buffer out of range	Same as code 0002
000D	Coupler alarm condition	Same as code 0002
000E	Monitor stopped	Same as code 0002
000F	Too many worklists from one CLA	Same as code 0002
0010	Force load service message received	This is normal if a force load message was entered. Otherwise, take same action as code 0002.
0011	Bad MLIA initialization status	Same as code 0002
0012	Invalid halt code	Same as code 0002
0013	Chain address = 0	Same as code 0002
0014	Invalid halt code	Same as code 0002
0015	Invalid coupler orderword	Same as code 0002
0016	Invalid halt code	Same as code 0002
0017	Invalid halt code	Same as code 0002

In some cases, a halt code message is not generated. In these cases the dump listing, as generated from the host by the Network Dump Analyzer (NDA) program, must be consulted to find the cause of the failure.

In all cases where the cause of stoppage is not apparent, the CE or analyst will probably want to consult the dump listing. The format of the listing is shown later in this section.

## HALT CODES

Halt codes can be divided into three categories: 1) those primarily resulting from incorrect switch settings, 2) those caused by hardware malfunctions, and 3) those that can be either hardware or software problems.

The first category includes detection of a duplicate CLA address (halt code 0012). This condition is usually caused by two CLA switches being set to the same address. Such a fault can normally be corrected by the operator resetting the switches.

In the second category, the halt codes are the following:

- power failures (code 0001)
- memory parity error (code 0002)
- memory protect bit error (code 0003)
- bad MLIA initialization status (code 0011)

Such conditions are usually caused by some type of hardware failure and normally must be repaired by a CE.

The third category of halt codes (all those not already specified) are caused either by a hardware failure or by a software error. To correct this category of problems, the CE should normally first be called to check the hardware. If the hardware is functioning properly, a system analyst should be called.

## NOTE

Have all upline dumps taken by the host available for the CE and/or the system analyst.

## DUMP INTERPRETATION WITHOUT HALT MESSAGE

At most times when a halt occurs, halt codes are sent to the NOP console and dump interpretation is not needed. However, 1) if a halt occurs after loading but before completion of initialization, or 2) if the system becomes trapped in a looping condition during initialization (before the CCP header prints), dump interpretation may be necessary to determine which halt has occurred, or in which subroutine of the initiation section the program is looping.

## INTERPRETATION INSTRUCTIONS

When interpreting the upline dump printout to determine the cause of a halt or looping condition, first examine the contents of memory location 30<sub>16</sub> as reflected in the dump printout. If non-zero, a halt has occurred and the halt code value is contained in that location.

If memory location 30<sub>16</sub> equals zero, examine the address of the NPINTAB entry in the address table which begins at fixed memory address 150<sub>16</sub>. (This is the table which is displayed at the end of a successful initialization. NPINTAB has a fixed address; it is the last non-zero entry in the address table.) Table B-6 lists the contents of the address table. Entry NPINTAB gives the starting address for the NPINTAB table, the format of which is illustrated in figure B-1. The NPISFL entry in the NPINTAB table contains the flags which mark the initialization subroutines that have completed running when the looping condition occurred. This information should be given to the system analyst along with the dump printouts.

A sample dump, formatted by NDA, is shown in figure B-2.

TABLE B-6. ADDRESS TABLE

Location	Address	Title/Routine	
150 <sub>16</sub> 0	BYWLCB	Worklist control block	Base
1	JSWLADDR	WL entry by LEVELNO	
2	B1TCB	Internal processing TCB	
3	B1BUFF	Internal processing block	
4	JKMASK	Interrupt masks	
5	JKTMASK	PBAMASK save area	
6	CBTIMTBL	TIMAL table	
7	JACT	PD controller table	
8	BECTLBK	Buffer control block (BCB)	
9	BYSTAMP	Buffer stamp area	
A	CLBFSPACE	Buffer space in number of small buffers	
B	0		
C	NAPORT	Port table	Mux sub-system
D	BQCIB	Circular input buffer (CIB)	
E	0		
F	CGLCBS	Line control blocks (LCB)	Lines and TIPS
10	CHSUBLCB	Sub line control blocks	
11	CGTCBS	Terminal control blocks (TBC)	
12	BJTIPTYPT	TIP type table	
13	NJTECT	Terminal characteristics table	
14	0		
15	NPINTAB	Initialization complete table	Initializa-tion Infor-mation
16	0		
17	CCPVER	CCP version address	
18	CCPCYC	CCP cycle address	
19	CCPLEV	CCP level address	
1A	0		

NOTE: Fixed table begins at main memory location 150<sub>16</sub>. Contents of table are displayed at end of a successful initialization.

	15	14	13	12	11	10	9	8	7	6	5	4	3	2	1	0
WORD 0 (NPSODD)	0	0	0	0	0	0	0	0	X	X	X	X	X	X	X	X
WORD 1 (NPISFL)	B15	0	0	0	0	0	0	0	B7	B6	B5	B4	B3	B2	B1	B0
WORD 2 (NPBMLS)	Y	Y	Y	Y	Y	Y	Y	Y	Y	Y	Y	Y	Y	Y	Y	Y

NPSODD - Duplicate CLA address, where XX...XX is the duplicated CLA address between 01<sub>16</sub> and FE<sub>16</sub>. 00<sub>16</sub> indicates preset value (no duplicates), and FF<sub>16</sub> indicates no response.

NPISFL - Initialization completion sequence flags, where B15 and B7 through B0 indicate start or completion of various tasks as follows:

- B15 - All buffers initialized, system initialization completed
- B7 - Second phase of buffer initialization started/completed
- B6 - Initialization of fixed lines started/completed
- B5 - Initialization of MLIA started/completed
- B4 - Application initialization started/completed
- B3 - Miscellaneous NPU console initialization started/completed
- B2 - Initialization of worklist control blocks started/completed
- B1 - Initialization of buffers started/completed
- B0 - Set up program protect bits started/completed

NOTE

A function is completed if the next higher bit is set, otherwise it was started but not completed.

NPBMLS - Bad MLIA initialization status, where any value for YY..YY other than 0009<sub>16</sub> indicates bad status. Call a Customer Engineer.

Figure B-1. NPINTAB Table Starting Address Format

NPU DUMP = 0003      NDA (DN=03)      NDA VER 1.1

CHANNEL      04  
 EQUIPMENT    07  
 TIME          00.14.05  
 DATE          78/09/02  
 NPU NAME     NODE2

header information  
 Record 1

BASE FILE 1 REGISTERS

ADDRESS	0	1	2	3	D	E	F	
000000	0000	0508	0500	0000	AEE0	AEE3	3720	
000010	0560	0F00	0000	0D00	0004	00E0	BABE	
000020	007F	0064	0064	0001	0007	000F	7D55	
000030	AAD8	165E	ACD8	0000	0000	0001	0000	
000040	0001	B720	0000	00FE	0085	0000	0801	
000050	0000	0000	0200	8000	0000	0000	0304	
000060	0EDA	0000	36B2	B723	...	0000	000F	2000
000070	1175	0001	0005	0006	401F	0000	0008	
000080	0F16	0014	0000	0050	B590	B59F	000C	
000090	12B3	0000	B5B0	0000	A180	0000	0000	
0000A0	86C5	1F27	0018	0000	00F0	0000	00F8	
0000B0	004D	004D	0000	0000	0071	7D08	0000	
0000C0	0000	0000	0000	0000	0000	0000	0000	
0000D0	001F	0000	BDC0	0000	0000	0000	0000	
0000E0	BDF8	0000	2C83	BE85	0000	0000	0000	
0000F0	0000	0000	0000	0000	0000	0000	AA2D	

Micromemory dump  
 Record 2

File 1 registers in groups of 16 words per line. Code is hexadecimal

COUPLER STATUS REGISTER	0000	} A
NPU STATUS WORD	0000	
ORDERWORD	0000	

MACROMEMORY

ADDRESS	0	1	2	3	D	E	F	
000000	0B00	0B00	0B00	0B00	0B00	5400	A9F6	
000010	0011	0807	0000	0000	0000	0000	0000	
000020	0000	0000	0000	0000	0000	0000	0000	
000030	0000	0000	0000	0000	0000	0000	0000	
000040	0000	0044	00FE	0000	0002	0001	0001	
000050	0001	0000	0044	0000	0030	0052	0000	
000060	0001	472C	1263	111F	FFFE	0091	0001	
000070	0002	0019	0001	0019	0001	0002	0001	
000080	0001	0001	457A	0001	...	0000	0000	0000
000090	0000	0000	0000	0000	0000	0000	0000	
0000F0**	0000	0000	0000	0000	0000	0000	0040	
000100	0000	1400	1BA8	0000	1400	1C0F	0000	
000110	0000	1400	3715	0000	1400	372D	0000	
000120	F010	1400	1C4E	0000	1400	3751	0000	
000130	0000	1400	375D	0000	1400	3781	0000	
000140	1400	0000	1400	D108	1400	3781	0000	
000150	1125	11F5	1064	1065	0000	0000	0000	
000160	1518	1563	15CA	1699	AAD8	0000	AF21	
000170	0000	0000	E8FD	E600	0000	0000	0000	
000180	5400	4761	12AF	1071	CEF6	6400	12B3	
	.	.	.	.	.	.	.	
	.	.	.	.	.	.	.	
	.	.	.	.	.	.	.	

For a 2552, both base and mux sides of main memory are dumped. The base side precedes the mux side. Identify a record by addresses

Main memory dump  
 Record 3

If lines have identical information, lines after the first are omitted. New line with unique information is flagged with \*\*. Sixteen words per line. Code is hexadecimal.

Figure B-2. Sample NPU Dump

**Accounting Data -**

Data collected by the TIP which counts the amount of I/O batch data passed to or received from a terminal. Examples: at the end of a card reader input job, the TIP informs the host of the number of cards read; at the end of a printer output, the TIP informs the host of the number of lines of text sent to the printer.

**Address -**

A location of data (as in the main or micro NPU memory) or of a device (as a peripheral device or terminal). The NPU main memory is paged.

**APL -**

A scientific programming language characterized by powerful operators defined as single keyboard symbols.

**Application Program -**

A program resident in a host computer. The program provides an information storage, a retrieval, and/or processing service to a remote user via the data communications network and the Network Access Method.

**Async Protocol -**

The protocol used by asynchronous, teletypewriter-like devices. For CCP, the protocol is actually the set of protocols for eight types of real terminals. The NPU/terminal interface is handled by the ASYNC TIP.

**Autoinput -**

An output mode that appends the first 20 characters of the output message to the input reply.

**Autorecognition -**

A capability offered to most terminals which allows the TIP to generate some device characteristics for the terminal, rather than having the terminal generate the information for itself.

**Bandwidth -**

For CCP, bandwidth indicates the transfer rate (in characters per second) between the NPU and the terminal.

**Base System Software -**

The relatively invariant set of programs in CCP that supplies the monitor, timing, interrupt handling, and multiplexing functions for the NPU. Base software also includes common areas, diagnostics, and debugging utilities.

**Batch File Command -**

A command from RBF in the host which alters the file characteristics of subsequent data transfers for a batch device. The characteristics which can be changed include: code type, suppressing carriage control on output, changing file limits (maximum size of a file in characters), and whether or not lace cards should be generated for a card punch. For HASP and BSC terminals, transparent mode and 026/029 card type can be changed from a terminal through a request to RBF.

**Binary Synchronous Communications (BSC) -**

A communications protocol supported by the BSC TIP. This protocol connects IBM 2780 or 3780 terminals to the NPU using half-duplex synchronous transmissions in a point-to-point mode. The terminals have batch devices which use EBCDIC code. Transparent data exchanges are permitted. The terminals are structured to have a virtual console (interactive device). This is composed of a card reader for input and a printer for output.

**BIP -**

Block interface package. A group of modules that provide routing, service message handling, and some common TIP subroutines including assistance in IVT block and PRUB formation for upline messages. By making hold/queue decisions for downline batch messages, the BIP also has some batch data stream flow control capability.

**Block -**

A unit of information used by networks. A block consists of one or more words (2 bytes/word) and contains sufficient information to identify the type of block, its origin, destination, and routing. Differing block protocols apply to the host/NPU and the NPU/terminal interfaces.

**Block Protocol -**

The protocol governing block transfers of information between the host and the local NPU. Data is transferred in IVT blocks or PRU blocks (PRUBs).

**Break -**

An element of a protocol indicating an interruption in the data stream. User breaks (a break normally entered by an operator at an interactive terminal) stops delivery of a message from the host.

**Broadcast Message -**

A message generated by the system or by an operator using the system. The message is sent to one (broadcast one) or all (broadcast all) of the terminals in the system.

**Buffer -**

A collection of data in contiguous words. CCP assigns two sizes of buffers for data and two other sizes of buffers for internal processing. A buffer usually has a header of one or more words. Data within a data buffer is delimited by pointers to the first and last characters (data buffers are character oriented). If the data cannot all fit into one buffer, an additional buffer is assigned and is chained to the current buffer. Buffer assignment continues until the entire message is contained in the chain of buffers. Buffers are chained together only to the forward direction.

**Buffering -**

The process of collecting data together in buffers. Ordinarily, no action on the data is taken until the buffer is filled. Filled buffers include the case where data is terminated before the end of the buffer and the remaining space is filled with extraneous matter.

**Buffer Threshold -**

The minimum number of buffers available for assignment to new tasks. As the buffer level falls toward the threshold, new tasks are rejected (regulation).

**Byte -**

A group of contiguous bits. For data handling within the NPU/host interface, a byte is 8 bits; IVT uses 7-bit ASCII characters with the eighth bit reserved for parity; PRU uses 6-bit display code right justified in the 8-bit space.

**Cassette -**

The magnetic tape device in an NPU used for bootstrap loading of off-line diagnostics and (in remote NPUs) the bootstrap load/dump operation.

**CCP -**

Communications Control Program. This set of modules performs the tasks delegated to the NPU in the network message processing system.

**CE Error Message -**

A diagnostic message sent upline to the host from the NPU. The message contains information concerning hardware and/or software malfunctions.

**Character -**

A coded byte of data. Host applications processing interactive data expect ASCII characters; host applications processing batch data expect display code. Terminals expect a wide range of codes. The TIPs are responsible for translating between terminal codes and host codes.

**CIB -**

Circular Input Buffer. This fixed buffer is used by the mux subsystem to collect all data passing upline from the multiplexer. The buffer is controlled by a put pointer for the multiplexer and a pick pointer used to demultiplex data to individual line-oriented data buffers.

**Command Driver -**

The hardware driver that controls the mux subsystem.

**Common Area -**

Areas of main memory dedicated to system and global data. These are usually below address 1000<sub>16</sub>.

**Communications Supervisor (CS) -**

A portion of the network software resident in the host. CS is written as an application program; the Communications Supervisor coordinates the network-oriented activities of the host computer and of the lines and terminals logically linked to it.

**Configuration -**

See System Configuration.

**Connection Number (CN) -**

A number specifying the path (line) used to connect the terminal through the NPU to the host.

**Console -**

A terminal devoted to network control processing. Examples of consoles are the Network Operator's (NOP) terminal and the Local Operator's (LOP) terminal. A console attached to the NPU can be used for offline processing.

**Contention -**

The state that exists in a bidirectional transmission line when both ends of the line try to use the line for transmission at the same time. All protocols contain logic to resolve the contention situation.

**Control Blocks -**

(1) The types of blocks used to transmit control (as opposed to data) information; (2) Blocks assigned for special configuration/status purposes in the NPU. The major blocks are line control blocks (LCB), logical link control blocks (LLCB), logical channel control blocks (LCCB), terminal control blocks (TCB), queue control blocks (QCB), buffer maintenance control blocks (BCB), mux line control blocks (MLCB), text processing control blocks (TPCB), and diagnostics control blocks (DCB).

**Coupler -**

The hardware interface between the local NPU and the host. Transmissions across the coupler use block protocol.

**CRC -**

Cyclic Redundancy Check. A check code transmitted with blocks/frames of data. It is used by several protocols including the HASP and CDCCP protocols.

**Cross -**

The software support system for CCP. These programs, which are run on the host, support source code programming in PASCAL, macroassembler, and microassembler languages. The compiled or assembled outputs of the Cross programs are in object code format on host computer files (source code is also kept in host files). The object code files are processed by other Cross programs and host installation programs into a downline load file for an NPU.

**Data -**

Information processed by the network or some components of the network. Data usually has the form of messages, but commands and status are frequently transmitted by using the same information packets as data (for instance, system messages).

**Data Compression -**

The technique of transmitting a sequence of identical characters as a control character and a number representing the length of the sequence. HASP and BSC protocols support data compression.

**Data Set -**

A hardware interface which transforms analog data to digital data and the converse.

**DDLTs -**

Special diagnostic programs which use a highly structured table technique to aid the troubleshooter in isolating a problem.

**Debugging -**

The process of running a program to rid it of anomalies. CCP supplies debugging aids for programs (TUP, PBTIPDG, and PBDEBUG) and for run-time PASCAL programs (QDEBUG and its associated programs).

**Diagnostics -**

Software programs or combinations of programs or tables which aid the troubleshooter in isolating problems.



#### Direct Calls -

The method of passing control directly from one program to another. This is the usual transfer mode for CCP. Some CCP calls are indirect, through the monitor. Such OPS level indirect calls pass information to the called program through parameter areas called worklists. See Worklist.

#### Directories -

Tables in CCP which contain information used to route blocks to the proper interface and line. There are directories for source and destination node and for connection number. A routed message is attached to the TCB for the line over which the message will pass.

#### DMA -

Direct Memory Access. The high-speed I/O channel to the NPU main memory. This channel is used for host/NPU buffered transfers.

#### DN -

Destination Node. The network node to which a message is directed; for instance, the DN of an upline message may be the host process (CS) which passes the message to the application program responsible for processing the message.

#### Downline -

The direction of output information flow, from host to NPU to terminal.

#### Dump -

The process of transferring the contents of the NPU main memory, registers, and file 1 registers to the host. The dump can be processed by the Network Dump Analyzer in the host to produce a listing of the dumped hexadecimal information.

#### Echo -

The process of displaying a keystroke on a terminal's display. Echoing can be done from the TIP, from a modem, or from the terminal itself.

#### FE -

Format Effectors. See below.

#### File -

A unit of batch data. Files are transferred between application programs and terminals by using PRUBs on the NPU's host side and transmission blocks on the NPU's terminal side. A file contains one or more records. Example: a card reader job can consist of a file containing the card image records of all the cards in the job deck.

#### File Registers -

The two sets of microregisters (file 1 and file 2) in the NPU. File 1 registers contain parameter information that is reloaded whenever the NPU is initialized. Microprograms using file 1 registers may also change values in them. File 2 registers are invariant firmware registers that come preprogrammed with the NPU.

#### Format Effectors -

Characters in an output data stream that determine the appearance of data at the terminal. A format effector usually takes the form of a single character in the output message. For printers, the character is translated by the output side of the TIP into a combination of carriage returns, line feeds, or spaces. Similarly, FEs for displays can command new lines, screen clearing, or cursor positioning.

#### Frame -

A medium for transmitting data across a high-speed link. Frames of different types are used by the LIP and by the X.25 TIP. A frame provides high data density in bit-serial format over data-grade lines. Data assurance is also provided.

#### Frame (LIP) -

The basic communications unit used in trunk (NPU to NPU) communications. Frames are composed of control bytes, a CRC sum, and (in some cases) data bytes in sub-block sequence. A sub-block may be a block protocol block or a part of a block. Frames are transmitted as a sequence of bytes through the mux subsystem.

#### Frame (MUX) -

The mux subsystem uses a hardware-controlled frame on the input and output mux loops.

#### Full Duplex (FDX) -

A transmission mode allowing data transfer in both directions at the same time. An FDX system requires a dual set of data lines, each set dedicated to transmission in one direction only.

#### Function Codes -

Codes used by the service module to designate the type of function (command or status) being transmitted. Two codes are defined: Primary Function Code (PFC) and Secondary Function Code (SFC). See Appendix C of the CCP System Programmer's Reference Manual for definitions of these codes.

#### Global Variables -

PASCAL variables which are defined for use by any CCP program. Contrast global variables with local variables, which are identified only within a program.

#### Halt Codes -

Codes generated by the NPU when it executes a soft-stop. These codes, which indicate the cause of the stoppage, are sent to the host's engineering file. They are also contained in a CCP dump.

#### Half Duplex (HDX) -

A transmission mode allowing data transfer in one direction at a time. Normally a single set of data lines carry input, output, and part of the control information. Contention for use is possible in HDX mode and must be resolved by the protocol governing line transfers.

#### HASP -

A protocol based on the BSC protocol; it is used by HASP workstations. A workstation has both interactive and batch devices. The standard code of all HASP devices is EBCDIC; however, transparent data exchanges with the host are also permitted. The HASP TIP converts interactive HASP data between EBCDIC transmission blocks and ASCII IVT blocks; it converts batch HASP data between EBCDIC transmission blocks and display code PRUBs.

#### Header -

The portion or portions of a message holding information about the message source, destination, and type. During network movement, a message can acquire several headers. For example, during movement of a message from a terminal to the host over an X.25/NOS network, the message acquires the following headers: one at the terminal (also a trailer), one for the frame, one for the packet, and another for the host block. Headers are discarded by the appropriate stage of processing, so that in this example, the host sees only the host block header. Conversely, headers are generated and discarded as needed downline, so that the terminal sees only the terminal header (and trailer).

#### High-Speed Synchronous Line -

A data transmission line operating at or above 19,200 baud. These lines are normally used for local LIP/remote LIP transfers and for PDN/NOS network transfers.

#### HIP -

Host Interface Package. The CCP program which handles block transfers across the host/local NPU interface. The HIP transfers control blocks and data blocks (IVT blocks or PRUBs).

#### Host -

The computer that controls the network and contains the applications programs that process network messages.

#### ID -

Identifiers. Identifiers can refer to port/subport, nodes, lines, links, or terminals. Any hardware element or connection can have an ID, normally a sequentially assigned number.

#### Initialization -

The process of loading an NPU and optionally dumping the NPU contents. After downline loading from the host, the NPU network-oriented tables are configured by the host so that all network processors have the same IDs for all network terminals, lines, trunks, etc.

#### Input Buffer -

A data buffer reserved by CCP for receiving an upline message for the host. These buffers are assigned and released dynamically. Contrast with the CIB on the mux subsystem interface.

#### Interface (NPU) -

The set of hardware and software that permits transfers between the NPU and an external device. There are three principal interfaces: to the host through a coupler (block protocol in IVT or PRU format handled by a HIP), to a neighbor NPU via the mux subsystem (CDCCP protocol handled by a LIP), and to the terminals (various protocols). Standard terminal protocols are handled by the ASYNC, BSC, MODE 4, HASP, and X.25 TIPs.

#### Interrupts -

A set of hardware lines and software programs that allow external events to interrupt NPU processing. Interrupting programs allow preferential processing on a priority basis. The lowest priority level is processed by an OPS monitor.

#### IVT -

Interactive Virtual Terminal. A block protocol format for interactive terminals. CCP TIPs convert all upline interactive messages to this format (exception: no transformations are made to transparent data except to put the messages into block format). By this method, application programs in the host need only to be able to process interactive data in IVT format rather than in the multiplicity of formats that real terminals use. Downline messages from the host to interactive terminals (including virtual consoles) are converted from IVT to real terminal format. IVT processing is controlled by the TIPs; the TIPs use some common IVT modules.

#### IVT Commands -

A group of commands that allow the operator at the terminal or a host application program to control some of the IVT transforms made by a TIP. These commands can (1) change the destination of the terminal characters for breaks and cancel signals, (2) select output page format (such as page width and length, number of padding characters after a line feed or carriage return), (3) designate parity type, terminal class, and other terminal-related features.

#### LCB -

Line Control Block. A table assigned to each active line in the system. It contains configuration information as well as current processing information.

#### LCCB -

Logical channel control block. A data structure holding information about logical channels. These are used by the X.25 TIP for terminals connected to the NOS network through a public data network.

#### Line -

A connection between an NPU and a terminal.

#### Link -

A connection between two NPUs or an NPU and a host. In release 3.1, a line which connects NPUs is the same as a trunk.

#### LIP -

Link Interface Package. The CCP program which handles frame transfers across a trunk; that is, across the connection between a local and a remote NPU. A LIP uses CDCCP protocol and interfaces on the local NPU side to the HIP. On the remote NPU side, the LIP interfaces with the appropriate TIP. In both local and remote NPUs, the LIP interfaces with the mux sub-system for transfer across the trunk.

#### LLCB -

Logical Link Control Block. A table assigned to each logical link in the system which touches this NPU. The table contains configuration information as well as current processing information.

#### Load -

The processing of moving programs downline from the host and storing them in the NPU main and micromemory. Loading of a remote NPU is accomplished by the host through the use of overlays in the local NPU.

**Local NPU -**

An NPU which is connected to the host via a coupler. A local NPU always contains a HIP for processing block protocol transfers across the host/local NPU interface.

**Logical Connection -**

A logical message path established between two application programs or between a network terminal and an application program. Until terminated, the logical connection allows messages to pass between the two entities.

**Logical Line -**

The basic message unit of a terminal. In most cases a logical line is designated by a carriage return. See Physical Line.

**Logical Link -**

See Link.

**Local Operator (LOP) -**

The operator of that terminal in the network that is connecting a specific application program in the host to the messages being processed. The terminal by default is the host terminal, but the LOP can be transferred to any other interactive terminal in the network. The operator manages the communications elements of the network within the local computer system by communicating with the Communications Supervisor in the host computer. Contrast with network operator. The local operator is an administrative operator within the network and need not be the host computer's operating system operator.

**Loop Multiplexer (LM) -**

The hardware which interfaces the CLAs (which convert data between bit-serial digital and bit-parallel digital character format) and the input and output loops.

**Low/Medium-Speed Voice-Grade Line -**

A line that operates at bit transmission rates at or below 19,200 baud. These lines characteristically connect individual terminals to an NPU or to a PAD access device. Such lines can be either dedicated or dial-up. Normal telephone lines operate in this transmission range.

**Main Memory -**

The macromemory of the NPU. It is partly dedicated to programs and common areas; the remainder is buffer area used for data and overlay programs. Word size is 16 data bits plus three additional bits for parity and program protection. Memory is packaged in 16K and 32K word increments.

**Mask -**

A bit pattern used in the interrupt subsystem to check if an interrupt is of sufficiently high priority to be processed now. An interrupt mask (M) register is used in this processing.

**Message -**

A logical unit of information, as processed by an application program. When transmitted over a network, a message can consist of one or more physical blocks.

**Mode 4 -**

A communications line transmission protocol for synchronous terminals. The protocol requires the polling of sources for input to the data communications network. CCP supports Mode 4A, 4B and 4C terminals. Mode 4A equipment is polled through a single hardware address (usually that of the console device), regardless of how many devices use the address as the point of interface to the network. Mode 4C equipment is polled through several hardware addresses, depending on the point each device uses to interface with the network. The Mode 4 TIP processes the interface between the NPU and the Mode 4 terminals.

**Modem -**

A hardware device for converting analog levels to digital signals and the converse. Long lines interface to digital equipment via modems. Modem is synonymous with data set.

**Micromemory -**

The micro portion of the NPU memory. This consists of 2048 words of 60-bit length. 1024 words are Read Only Memory (ROM); the remaining 1024 words are Random Access Memory (RAM) and are alterable. The ROM memory contains the emulator microprogram that allows use of assembly language.

**Microprocessor -**

The portion of the NPU that processes the programs.

**MLIA -**

Multiplex Loop Interface Adapter. The hardware portion of the mux subsystem that controls the mux loops (input and output) as well as the interface between the NPU and the mux subsystem.

**Module -**

See program.

**Monitor -**

The portion of the NPU base system software responsible for time and space allocation within the computer. The principal monitor program is OPSMON, which executes OPS level programs by scanning a table of programs which have pending tasks.

**Mux Subsystem -**

The portion of the base NPU software which performs multiplexing tasks for upline and downline data, and also demultiplexes upline data from the CIB and places the data in line-oriented data input data buffers.

**NAM -**

See Network Access Method.

**Neighbor NPUs -**

Two NPUs connected to one another by means of a trunk. The NPU connected to the host via a coupler is designated as the local NPU. The other NPU is a remote NPU; it is not connected directly to the host in any fashion.

**Network -**

An interconnected set of network elements consisting of a host, one or more NPUs, and terminals.

**Network Access Method (NAM) -**

A software package that provides a generalized method of using a communications network for switching, buffering, queuing, and transmission of data. NAM resides in the host.

**Network Definition Language (NDL) -**

The compiler-level language used to define the network configuration file and local configuration file contents.

**Network Logical Address -**

The address used by block protocol to establish routing for the message. It consists of three parts; DN - the destination node, SN - the source node, and CN - the connection number.

**Network Operator (NOP) -**

An administrative operator at the network operator console. This terminal by default is the host console, but the NOP function can be assigned to any other terminal in the system. The network operator manages the NPU hardware, linkages, and other network elements of the entire data communications network by communicating with the Network Supervisor in the network control center host computer. Contrast with local operator. The network operator can also be a local operator, but need not be the operating system operator for the host computer at the network control center.

**Network Processing Unit (NPU) -**

The collection of 255X hardware and peripherals together with the software that includes Communications Control Processor (CCP) macromemory modules. These CCP programs buffer and transmit data between terminals and host computer.

**Network Supervisor (NS) -**

A portion of the network software which coordinates all of the NPUs in the communications network. NS is written as an application program.

**Node -**

A network element that creates, absorbs, switches, and/or buffers message blocks. Typical system nodes are NS and CS in the host, the coupler node of a local NPU and a terminal node of a remote NPU.

**Off-Line Diagnostics -**

Optional diagnostics for the NPU that require the NPU be disconnected from the network.

**On-Line Diagnostics -**

Optional diagnostics for the NPU that can be executed while the NPU is connected to, and operating as a part of the network. Individual lines being tested must, however, be disconnected from the network. These diagnostics are provided if the user purchases a network maintenance contract.

**OPS Monitor -**

The NPU monitor. See Monitor.

**Output Buffer -**

Any buffer which is currently used to output information from the NPU to another NPU or to a terminal via the mux subsystem.

**Overlay Area -**

An area in upper main memory which is used to execute overlay programs.

**Overlay Programs -**

Programs which are not normally resident in main memory but which are called into the buffer area of main memory to execute special tasks. These programs are downline loaded (usually) from the host and perform such tasks as NPU initialization debugging, loading/dumping a remote NPU, and on-line diagnostics.

**Packet -**

A group of binary digits, including data and call control signals, which is switched as a single unit. The data, control signals, and error-control information are arranged in a specific format.

**Packet Assembly/Disassembly (PAD) -**

Assembly: The accumulation of characters from an asynchronous device into data blocks for transmission via a PDN. Disassembly: The encoding of blocks for transmission to an asynchronous terminal.

**PAD SubTIP -**

A subTIP used with the X.25 TIP which allows a class of asynchronous terminals to communicate over a public data network.

**Paging (NPU) -**

A method of executing programs and accessing data in the NPU main memory region above 65K. Paging is required for addressing where the address is larger than 16 bits (NPU word size) in length.

**Paging (Screen) -**

The process of filling a CRT display with data and holding additional data for subsequent displays. Changing the paged display is an operator controlled function if the page wait option is selected.

**Parity -**

A type of data assurance. The most common parity is character parity; that is, the supplying of one extra bit per character so that the sum of all the bits in the character (including the parity bit) is always an even or odd number.

**PASCAL -**

A high level programming language used for CCP programs. Almost all CCP programs are written in PASCAL language.

**PFC -**

Primary Function Code. See Function Codes.

**Physical Line -**

A string of data that is determined by the terminal's physical characteristics (page width or line feed). Contrast with logical line, which is determined by a carriage return or other forwarding signal.

**Physical Link -**

A connection between two major network nodes such as neighboring nodes. Messages can be transmitted over active physical links.

**Polling -**

The action of checking terminals to find if an input device is ready to transmit upline data. Certain TIPs (such as Mode 4) poll terminal devices for data. The host requests such polling; the TIP determines the timing of the polling operation.

**Port (P) -**

The physical connection in the NPU through which data is transferred to/from the NPU. Each port is numbered and supports a single line. Supports are possible but not used in this version of CCP.

**PPU (Peripheral Processing Unit) -**

The part of the host dedicated to performing I/O transfers. The coupler connects the PPU directly to an NPU.

**Priority Level -**

A set of 17 levels of processing in the NPU. Priority levels are interrupt driven. The OPS monitor processes at the lowest priority level; that is, at a level below any interrupt-driven level.

**Program -**

A series of instructions which are executed by a computer to perform a task; usually synonymous with a module. A program can be composed of several subprograms.

**Protect System -**

A method of prohibiting one set of programs (unprotected) from accessing another set of programs (protected) and their associated data. The system uses a protect bit in the main memory word.

**Protocol -**

The complete set of rules used to transmit data between devices. This includes format of the data and commands, and the sequence of commands needed to prepare the devices to send and receive data.

**PRU -**

Physical record unit. A host batch file format. Batch data is exchanged with the host in PRU block (PRUB) format to minimize the amount of conversion a host performs to make network data compatible with host file handling capabilities.

**PRU Commands -**

A set of commands from the host or a terminal that changes batch device or batch file characteristics, alters batch data stream flow, or transmits accounting data to the host. All batch file and batch device commands can come from the host. A few batch file commands can also come from the terminal. Some batch stream flow commands come from the host; others come from the terminals. Accounting data commands come only from the terminals.

**PRUB -**

Physical record unit block. A block format for batch terminals that is compatible with the host's PRU (batch file) handling capabilities. CCP TIPs convert all upline batch messages to this format (exception: no transformations are made to transparent data except to put the messages into PRUBs). By this method, application programs in the host need only to be able to process batch data in PRU format rather than in the multiplicity of formats which real terminals use. Downline messages from the host to real batch devices are converted from PRUB to real terminal format. PRUB processing is controlled by the TIPs with the help of the BIP.

**Public Data Network -**

A network that supports the interface described in the CCITT protocol X.25.

**Queues -**

Sequences of blocks, tables, messages, etc. Most NPU queues are maintained by leaving the queued elements in place and using tables of pointers to the next queued element. Most queues operate on a first-in-first-out basis. A series of worklist entries for a TIP is an example of an NPU queue.

**Record -**

(1) A data unit defined for the host record manager (PRU); (2) a data unit defined for HASP workstations. In either case, a record contains space for at least one character of data and normally has a header associated with it. HASP records can be composed of subrecords.

**Regulation -**

The process of making an NPU or a host progressively less available to accept various classes of input data. The host has one regulation scheme, the host and mux interfaces of a local NPU have another scheme, and the mux interface to a neighbor NPU has a third regulation scheme. Some types of terminals (for instance, HASP workstations) may also regulate data. Data classifications are usually based on batch, interactive, and control message criteria.

**Remote NPU -**

An NPU connected only to other (local) NPUs. A remote NPU lacks a coupler; therefore it can have no direct connection to the host.

**Response Messages -**

A subclass of service (network control) messages directed to the host that are normally generated to respond to a service message from the host. Response messages normally contain the requested information or indicate the requested task has been started/performed. Error responses are sent when the NPU cannot deliver the information or start the task. A class of unsolicited response messages is generated by the NPU to report hardware failures.

**Routing -**

The process of sending data/commands through the NPU to the internal NPU process or to an external device (for instance, a terminal). The network logical address (DN, SN, CN) is the primary criterion for routing. The NPU directories are used to accomplish the routing function.

**Service Channel -**

The network logical link used for service message transmission. For this channel, CN=0. The channel is always configured, even at load time.

**Service Message (SM) -**

The network method of transmitting most command and status information to/from the NPU. Service messages use CMD blocks in the block protocol.

**Service Module (SVM) -**

The set of NPU programs responsible for processing service messages. SVM is a part of the BIP.

**SFC -**

Subfunction code. See Function Codes.

**Source Node (SN) -**

The network node originating a message or block of information.

#### State Programs -

Programs written in state programming language. These programs usually are part of a TIP (some are common to all TIPs), but do not operate on the OPS level. Instead they are reached by a call to the mux level or are operated automatically by the multiplex subsystem. State programs process modem signals, input data, and output data. Text processing is primarily performed by state programs.

#### State Program Tables -

Tables used by the mux subsystem to locate the next state program to execute.

#### Statistics Service Message -

A subclass of service messages that contain detailed information about the characteristics and history of a network element such as a line or a terminal.

#### Status -

Information relating to the current state of a device, line, etc. Service messages are the principal carriers of status information. Statistics are a special subclass of status.

#### String -

A unit of information transmission used by the HASP protocol. One or more strings compose a record. A string can be composed of different characters or contiguous identical characters. In the latter case, the string is normally compressed to a single character and a value indicating the number of times the character occurs.

#### Subport -

One of several addresses in a port. In this CCP configuration, subport is always equal to 0.

#### Subprogram -

A series of instructions which are executed by a computer to perform a task or part of a task. A subprogram may be called by several programs or may be unique to a single program. Subprograms are normally reached by a direct call from a program.

#### Supervisory Message -

A message block in the host not directly involved with the transmission of data, but which provides information for establishing and maintaining an environment for the communications of data between the application program and NAM, then through the network to a destination or from a source. Supervisory messages may be transmitted to an NPU in the format of a service message.

#### Switching -

The process of routing a message or block to the specified internal program or external destination.

#### System Configuration -

The process of setting tables and variables throughout the network to assign lines, links, terminals, etc., so that all elements of the network recognize a uniform addressing scheme. After configuration, network elements accept all data commands directed to/through themselves and reject all other data and commands.

#### Terminal -

An element connected to a network by means of a communications line. Terminals supply input messages to, and/or accept output messages from, an application program. A terminal can be a separately addressable device comprising a physical terminal or station, or the collection of all devices with a common address.

#### Terminal Control Block (TCB) -

A control block containing configuration and status information for an active terminal. TCBs are dynamically assigned.

#### Terminal Interface Packages (TIPs) -

NPU programs which provide the interface between real terminal format and IVT or PRU format. The standard TIPs are ASYNC, BSC, HASP, Mode 4, and X.25 with PAD subTIP. TIPs are responsible for data conversion and for some error processing.

#### Timeout -

The process of setting a time for completion of an operation and entering an error processing condition if the operation has not finished in the allotted time.

#### Timing Services -

The subset of base system programs which provide timeout processing and clock times for messages, status, etc. Timing services provide the drivers for the real-time clock.

#### Trailer -

Control information appended to the end of a message unit. A trailer contains the end-of-data control signals. Trailers can be generated by the terminal or by an intermediate device such as a frame generator. Not all headers are matched with trailers, although some devices split their control information between a header and a trailer. The trailer usually contains a data assurance field such as a CRC-16 or a checksum. Like headers, trailers are generated and discarded at various stages along a message unit's path.

#### Transparent Mode -

A data mode in which the TIP minimally formats the message and does no code translation. For most TIPs, transparency can occur on both upline and downline messages (files). If transparent mode is selected, the entire message/file must be in the receiving device's code and format (including all required header and trailer information). In some cases, transparent mode is specified by enclosing the message with transparent delimiting characters; in other cases, the mode of each file must be specified prior to beginning message transmission.

#### Trunk -

A line connecting two NPUs or an NPU and a host. The host/NPU trunk uses block protocol; the NPU/NPU trunk uses trunk protocol.

#### Trunk Protocol -

The protocol used for communicating between neighboring NPUs. It is a modified CDCCP protocol which uses the frame as the basic communications element.

**TUP (Test Utility Program) -**

A debugging utility that supports breakpoint debugging as well as other utility type operations such as loading and dumping.

**Typeahead (Terminal) -**

The ability of a terminal to enter input data at all times without losing output data currently in progress. This requires suspending the output operation until the input message is finished, and then resuming the interrupted output. The ASYNC TIP supports typeahead; the X.25 TIP supports typeahead if it is provided by the PDN.

**Unsolicited Service Messages -**

Service messages sent to the host which do not respond to a previous service message from the host. Unsolicited SMS report hardware or software failures to the host.

**Upline -**

The direction of message travel from a terminal through an NPU to the host.

**Virtual Channel (X.25/PAD) -**

A channel defined for moving data between a terminal and a host. Virtual channels are defined for the length of time that the terminal is connected to the PDN.

**Word -**

The basic storage and processing element of a computer. The NPU uses 16-bit word (main memory) and 32-bit word (internal to the microprocessor only).

All interfaces are 16-bit word (DMA) or in character format (mux loop interface). Characters are stored in main memory two per word. Hosts (CYBER series) use 60-bit words but a 12-bit byte interface to the NPU. Characters at the host side of the NPU host interface are stored in bits 19 through 12 and 7 through 0 of a dual-12-bit type.

Some terminals such as a HASP workstation can use any word size but must communicate to the NPU in character format. Therefore, workstation word size is transparent to the NPU.

**Worklists -**

Packets of information containing the parameters for a task to be performed. Programs use worklists to request tasks of OPS level programs. Worklist entries are queued to the called program. Entries are one to six words long, and a given program always has entries of the same size.

**Worklist Processor -**

The base system programs responsible for creating and queuing worklist entries.

**X.25 Protocol -**

A CCITT protocol used by the public data network. It is characterized by high-speed, framed data transfers over links. A PDN requires a PAD access for attaching asynchronous terminals.

**X.25 TIP -**

The CCP TIP that interfaces an NPU to a public data network.

# CCP MNEMONICS

D

ACK0/ACK1	Acknowledge Block (BSC/HASP protocol)	CMDR	Command Reject (trunk protocol)
ACN	Application Connection Number	CN	Connection Number (for blocks/SVM)
ACTL	Assurance Control Block	CND	Connection Number Directory
APL	A Programming Language	CR	Carriage Return
ARM	Asynchronous Response Mode	CRC	Cyclic Redundancy Check
ASCII	American Standard Code for Information Interchange	CRT	Cathode Ray Tube
ASYN	Asynchronous	CS	Communications Supervisor Program (in host)
BACK	Acknowledgment Block	CTL	Control Element (ASYN protocol)
BCB	Block Control Byte (HASP protocol)	DBC	Data Block Clarifier (for blocks/SVM)
BCD	Binary Coded Decimal	DCB	Diagnostics Control Block
BFC	Block Flow Control	DDLT	Diagnostic Decision Logic Table
BFR	Buffer	DEL	Delete Character
BIP	Block Interface Package	DM	Disconnect Mode (trunk protocol)
BLK	Message Block	DMA	Direct Memory Access (in NPU)
BN	Block Number (overlay)	DN	Destination Node (for blocks/SVM)
BRK	Break Block	DND	Destination Node Directory
BSC	Binary Synchronous Communication	DSR	Data Set Ready
BSN	Block Serial Number (for blocks/SVM)	DT	Device Type
BT	Block Type	EBCDIC	Extended Binary Coded Decimal Interchange Code
B1, B2	User defined breaks for HASP (protocols and other)	EC	Error Code
CA	Cluster Address	E-CODE	Device Codes (MODE 4 protocol)
CB	Control Block	ENQ	Enquiry Block (BSC/HASP protocol)
CCITT	Comite Consultif International Telephonique et Telegraphique (an international communications standards organization)	EOF	End of File
CDCCP	CDC Communications Protocol (trunk protocol)	EOI	End of Information
CDT	Conversational Display Terminal	EOJ	End of Job
CCP	Communications Control Program (in NPU)	EOM	End of Message
CE	Customer Engineer	EOR	End of Record (HASP protocol)
CFS	Configurator State (for SVM)	ETB	End of Transmission Block (HASP protocol)
CIB	Circular Input Buffer	ETX	End of Text
CLA	Communications Line Adapter	FCD	First Character Displacement (in buffer)
CMD	Command Block	FCS	Function Control Sequence (HASP protocol)
		FD	Forward Data (block protocol)



FDX	Full Duplex	LLREG	Logical Link Regulation
FE	Format Effector	LM	Loop Multiplex
FF	Forms Feed	LOP	Local Operator
FN	Field Number (for SVM)	LP	A series of TUP commands start with *LP
FRQ	Frame Retention Queue (trunk protocol)	LRN	Link Remote Node (for SVM)
FS	Forward Supervision (block protocol)	LT	Line Type
FV	Field Values (for SVM protocol)	M	Mask Register
HASP	Houston Automatic Spooling Protocol	MLCB	Mux Line Control Block
HCP	Host Communications Processor (alternate name for NPU)	MLIA	Mux Loop Interface Adapter
HDLC	High Level Data Link Control	MM	Main Memory
HDX	Half Duplex	MPLINK	The PASCAL Linking Editor
HIP	Host Interface Package	MSG	Message Block
HL	High Level	MTI	Message Type Indicators (MODE 4 protocol)
HO	Host Ordinal	M4	MODE 4
IAF	Interactive Facility Program (in host)	NAK	Negative Acknowledgment Block (BSC/HASP protocol)
ICMD	Interrupt Block	NAM	Network Access Method Program (in host)
ICMDR	Interrupt Response Block	NCF	Network Configuration File (in host) (NS controlled)
ID	Identifier (number of code)	NDA	Network Dump Analyzer (in host)
IDC	Internal Data Channel (in NPU)	NDLP	Network Definition Language (for host)
I-FRAME	Information Frame (for trunk protocol)	NHP	Network Host Products
INIT	Initialization Block	NIP	Network Interface Program
I/O	Input/Output	NOP	Network Operator
ISO	International Standards Organization	NPINTAB	NPU Table
IVT	Interactive Virtual Terminal Format	NPU	Network Processing Unit
LBN	Last Block Number (overlay)	NS	Network Supervisor Program (in host)
LCB	Line Control Block (in NPU)	NVF	Network Validation Facility (in host)
LCCB	Logical Channel Control Block (in NPU)	ODD	Output Data Demand (Mux subsystem)
LCD	Last Character Displacement (LCD)	OPS	Operational (OPS level = Monitor level programs)
LCF	Local Configuration File (in host) (CS controlled)	OPSMON	Monitor
LD	Load/Dump	P	Port
LF	Line Feed	PAD	Packet Assembly/Disassembly
LIDLE	Idle Element (trunk protocol)	PCB	Program Control Block
LINIT	Line Initialization Element (trunk protocol)	PDN	Public Data Network
LIP	Link Interface Package (in NPU)	PFC	Primary Function Code (for SVM)
LL	Logical Link	PL	Page Length (IVT)
LLCB	Logical Link Control Block (in NPU)		

PPU	Peripheral Processing Unit (in host)	SYNC	Synchronizing Element (MODE 4 protocol)
PRU	Physical Record Unit	TA	Terminal Address
PRUB	Physical Record Unit Block	TAF	Transaction Facility (in host)
PW	Page Width (IVT or PRU)	TC	Terminal Class
QCB	Queue Control Block	TCB	Terminal Control Block (in NPU)
QDEBUG	PASCAL Debugging Package	TDP	Time Dependent Program
RAM	Random Access Memory	TIP	Terminal Interface Package (in NPU)
RBF	Remote Batch Facility Program (in host)	TIPTQ	TIP Trunk Queues (trunk protocol)
RC	Reason Code (for SVM) (also called response code)	TO	Timeout
RCB	Record Control Byte (HASP protocol)	TOT	Total Number of Trunks (SM)
RCV	Receive State	TPCB	Text Processor Control Block
REJ	Reject (trunk or X.25 protocol)	TT	Terminal Type
RIM	Request Initialization Mode (trunk protocol)	TTF	Trunk Transmission Frame
RL	Regulation Level	TTY	Teletype (asynchronous device)
RM	Response Message (SM)	TUP	Test Utility Program
RNR	Receive Not Ready (trunk or X.25 protocol)	TVF	Terminal Verification Facility (in host)
RR	Receive Ready (trunk or X.25 protocol)	UA	Unnumbered Acknowledgment (trunk or X.25 protocol)
RS	Reverse Supervision (block protocol)	U-FRAME	See UA and UI
RST	Reset Block	UI	Unnumbered Information Frame (trunk or X.25 protocol)
RT	Record Type	US	Unit Separator
RTS	Ready to Send (trunk protocol)	UT	User Terminal
SARM	Set Asynchronous Mode (trunk or X.25 protocol)	VAR	PASCAL Variable
SCB	String Control Byte (HASP protocol)	WL	Worklist
S-FRAME	Supervisory Frame (trunk or X.25 protocol)	WLCB	Worklist Control Block
SFC	Secondary Function Code (for SVM)	WLE	Worklist Entry
SIM	Set Initialization Mode (trunk protocol)	WLP	Worklist Processor
SM	Service Message	X-OFF	Stop Punch Character (ASYNCR protocol)
SN	Source Node (for blocks/SVM)	X-ON	Start Punch Character (ASYNCR protocol)
SND	Source Node Directory	XPT	Transparent Bit, paper tape (ASYNCR TIP)
SP	Support	X.25	CCITT Protocol for Public Data Network
SRCB	Subrecord Control Byte (HASP protocol)	X.28	CCITT Protocol for Terminal Access to PDN/PAD
STP	Stop Data Block	X.29	CCITT Protocol for host access to PDN/PAD
STRT	Start Data Block	X.3	CCITT Protocol for Asynchronous Terminal Access to a PDN
STX	Start of Text (ASYNCR protocol)		
SVM	Service Module for Processing Service Messages		

# SAMPLE MAIN MEMORY MAP FOR NPU

E

Figure E-1 shows the locations of the principal CCP program groups in a 255x network processor unit with 96K words of memory. It is assumed that this is the smallest memory size that will be used with PRU, the HIP, a LIP, and at least one TIP. Note that the HIP, LIP, BIP, and all TIPs are paged. It is assumed that the standard build procedures described in the CYBER Cross Build Utilities Reference Manual and in the NOS Installation Handbook are being used. Therefore, the user need not be concerned with assigning modules to the various regions shown here. Autolink automatically optimizes the amount of memory left for message processing buffers. (Autolink is described in the CYBER Cross Build Utilities Reference Manual.)

The example shown is an autolink generated load file for a local NPU (which requires a HIP and BIP) and three options: a LIP, the Mode 4 TIP, and the HASP TIP.

<u>Locations in Hexadecimal</u>	<u>Program Name</u>	
0000	Jump to BEGINX	ZEROX
0100	Interrupt trap locations	PBINTRP
0140	Jump locations	JUMPS
0150	Address table	ADDRES
0DA0†	PASCAL globals	GLOBL\$
1FAE†	Some base routines	
2000	BIP modules assigned to this area. HIP, LIP, TIP and other BIP modules assigned to pages above FFFF have their addresses imaged to this 2K (hex) page.	} 2K (hex) page of memory
4000	Base routines, mux routines, and routines associated with paged applications above FFFF are loaded in this base area by Autolink. Parts of TIPs that must be in base are always loaded in this region.	
8B83†	ID table - must be last base application (see Autolink directives)	PIDTBL
D897†		MAIN\$ } Reserved by autolink for buffers
D8AF†	Start of the initialization programs	BEGINX } Area released for use as buffers after initialization
FFFF	Initialization routines	} There is some mixing of modules from one application on the page assigned to another application. See autolink directives in the CYBER Cross Build Utilities Reference Manual
10000	Mode 4 TIP	
12000	HASP TIP	
14000	LIP and HIP	
16000	BIP	

†These addresses can fluctuate because of local mods, TIP selection differences, and PSR level.

Figure E-1. Sample CCP Memory Map

# CCP NAMING CONVENTIONS

F

The following naming conventions for the CCP PASCAL programs should be regarded as guidelines rather than as strict requirements.

The general format of a label is:

**PIRRRRSSS**

Where the usual length is six bytes, but additional bytes can be used.

P values are:	A - O	Global data
	P	Procedure or function
	Q - W	Local data
	X - Z	NonCDC
I values are:	0	Transparent or not tied down
	1 - 9	Not a structure
	A - Z	A structure

For procedures and functions:

P = P, I =	A	Assurance programs
	B	Base system or BIP programs
	D	Diagnostic programs
	M	Mux subsystem programs (part of the base system)

N	Network Communications programs
P	Packets
T	TIPs, HIP, LIP

For types, variables, fields, etc.:

BA...	Overlay
BF...	Buffer
BL...	Logical Link Control Block (LLCB)
BS...	Terminal CB (TCB)
BW...	Intermediate array for Worklist
BY...	Worklist CB (WLCB)
BZ...	Line CB (LCB)
D...	Service Module
J...	Input/Output (I/O)
JU...	TUP table
LD...	Load/dump
M...	Mux subsystem
MM...	Event interface
N...	Mux subsystem
NC...	Mux Line CB (MLCB) or Test Processing CB (TPCB)
NK...	Mux command driver inputs
NZ...	Diagnostics CB (DCB)

**TERMINAL MESSAGES**

All interactive terminals controlled by the NPU receive preformatted messages when the host becomes unavailable, and when the host is again available. A few output batch devices also receive these messages. The messages are:

- Host unavailable message:  
 HOST UNAVAILABLE
  
- Reply to a message sent upline to a host after the host unavailable message has been sent to the terminals:  
 INPUT DISCARDED
  
- Host again available message:  
 INPUT RESUMED

**INTERACTIVE TERMINAL COMMANDS**

An interactive terminal has a limited ability to alter certain IVT processing parameters. A summary of these alterable parameters is shown in figure G-1.

The general format of the command message that changes these parameters is:

CTL1 PARAMETER COMMAND CTL2

where CTL1 and CTL2 are the terminal's normal starting and ending characters to delimit messages. Each parameter command has the form of two characters followed by an equals sign followed by the selected value:

xx = value

If a TIP accepts the command, the TIP does not usually send a positive acknowledgment to the interactive device. However, if the TIP rejects the command (as in the case of a command that is invalid for the type of terminal being used), an error message is returned to the operator. The error message has the form:

ERR...

Table G-1 shows the IVT commands that can be entered from each type of terminal.

TC =	$\begin{bmatrix} 1 \\ 2 \\ 4 \\ \cdot \\ \cdot \\ 16 \\ 17 \end{bmatrix}$
PW =	< NNN >
PL =	< NNN >
PA =	$\begin{bmatrix} Z \\ O \\ E \\ N \end{bmatrix}$
CN =	< SELECTED CHAR >
BS =	< SELECTED CHAR >
CT =	< SELECTED CHAR >
CI =	$\begin{bmatrix} CA \\ < NN > \end{bmatrix}$
LI =	$\begin{bmatrix} CA \\ < NN > \end{bmatrix}$
SE =	$\begin{bmatrix} N \\ Y \end{bmatrix}$
DL =	(X<HH>) (,C<NNNN>) (,TO)
IN =	$\begin{bmatrix} KB \\ XK \\ PT \\ XP \\ X \end{bmatrix}$
OP =	$\begin{bmatrix} PR \\ DI \\ PT \end{bmatrix}$
CD =	A
EP =	$\begin{bmatrix} Y \\ N \end{bmatrix}$
PG =	$\begin{bmatrix} Y \\ N \end{bmatrix}$
AL =	< SELECTED CHAR >
B1 =	< SELECTED CHAR >
B2 =	< SELECTED CHAR >
MS =	< TEXT >

Figure G-1. Summary of IVT Commands Entered From a Terminal

TABLE G-1. TERMINAL PARAMETERS AS USED BY STANDARD TIPS

Command	MD4	BSC	HASP	ASYNC	X.25 with PAD
TC Terminal Class	AR††	B	B	AR††	AR
PW Page Width	AR	B	AR	AR	AR
PL Page Length	AR	B	B	AR	AR
PA Parity	B	B	B	A	A
CN Cancel Input Line Chain	A	B	A	A	A
BS Backspace	B	B	B	A	A
CT Control Character	A	A	A	A	A
CI CR Idle Count	B	B	B	A	A
LI LF Idle Count	B	B	B	A	A
SE Special Edit Mode	B	B	B	A	C
DL Transparent Delimiter	B	B	B	A/B†	A/I§§
IN Input Mode	A/B†††	B	B	A	I
OP Output Mode	B	B	B	A	I
CD Character Set Detect	B	B	B	A§	I
EP Echoplex Mode	B	B	B	A	I
PG Page	A	B	B	A	A
AL Abort Output Line	B	B	B	A	I
B1 User Break 1	A	B	A	A	A
B2 User Break 2	A	B	A	A	A
MS Message to Operator	C	C	C	C	C
Other or Invalid Parameters	B	B	B	B	B

A Take the commanded action  
 AR Take the commanded action and report to CS  
 B No action; send BRK block to host and ERR... message to terminal  
 C Valid only from user  
 I Ignore

†These commands are valid only for certain terminal classes. DL is not a valid command for terminal class 4 (IBM 2741). A BRK block will be sent to the application if any of these commands are received for a terminal in a class which does not support the command.

††An error will occur for any attempt to change mode between subTIPs. For ASYNC, terminal class 4 is not allowed if the extended ASYNC feature is not configured.

†††Transparent mode can be used only on mode 4C devices.

§The command is legal only if the NPU is configured to support the extended ASYNC feature. Otherwise, CCP sends BRK or ERR... message to the terminal.

§§Only the K, X, and KX options are allowed.

PARAMETER COMMAND DEFINITIONS

Terminal parameter definitions are:

- Terminal Class (TC)

TC establishes a class for the terminal with default values for all parameters as defined in table E-7. A TIP will not execute the command if the class is not supported. This change must be reported to CS in the host.

- Page Width (PW)

PW establishes the physical line width in characters for output. For non-transparent blocks, the TIP inserts the character sequence defined for the terminal class to move the carriage or cursor to the next line at the point where the number of characters to be transmitted equals the page width. The parameter NNN varies between 0 and 255; 0 means "new line" and is never inserted. This change must be reported to CS in the host.

- Page Length (PL)

PL establishes the number of physical lines in a page for output. The TIP inserts the character sequence defined for the terminal class to advance the carriage or cursor to the next page length. Also, if the page wait feature is selected, the TIP will wait for an operator input before continuing. The parameter NN varies between 0 and 255; 0 means no paging. This change must be reported to CS in the host.

NOTE

None of the remaining IVT parameter changes need be reported to the host (CS).

- Parity Selection (PA)

PA specifies the type of parity which the TIP expects on input and generates on output. See description of parity in the asynchronous TIP section of this manual.

- **Cancel Character (CN)**

CN establishes the character which is used to delete the current logical input line. If special edit mode is engaged, the CN character is treated as data and is sent to the host; the delete action is not performed.

- **Backspace Character (BS)**

BS establishes the character which is used to delete the previous input character from the current input buffer. If special edit mode is engaged, the BS character is treated as data and is sent to the host; the backspace action is not performed.

- **Control Character (CT)**

CT establishes the character which is used to enter operational control messages.

- **Carriage Return Idle Count (CI)**

CI establishes the number of idle characters to be inserted in the output stream following carriage return (CR). The use of CI-*nn* overrules the default value and CI-CA restores the default value.

- **Line Feed Idle Count (LI)**

LI establishes the number of idle characters to be inserted in the output stream following line feed (LF). The use of LI-*nn* overrules the default value and LI-CA restores the default value.

- **Special Edit Mode (SE)**

A SE = Y selection places the terminal in special edit mode; an SE = N selection returns the terminal to the normal character edit mode. Special edit mode provides two types of special operations:

- (1) backspace (BS), linefeed (LF), and cancel input control symbols are not treated as control characters by the TIP; instead, they are sent upline as data.
- (2) a character delete sequence (one or more backspaces followed by a linefeed) causes the TIP to issue a caret prompt to the terminal, and then to continue with input processing.

- **Transparent Text Delimiter (DL)**

DL establishes the transparent text delimiter for input. The delimiter may be a character, a character count or a timeout of 300 ± 100 ms. One or more of the delimiters may be active simultaneously.

- **Input Device (IN)**

IN specifies the input device as a keyboard or paper tape reader in character or transparent mode. Note that paper tape input is allowed in keyboard mode, but that the TIP does not send the <X-ON> characters to start the paper tape reader.

- **Output Device (OP)**

OP specifies the output device as printer, CRT display, or paper tape punch. Printer and CRT display are functionally equivalent. The user may punch a paper tape in any mode, but the TIP provides the X-OFF character only if OP=PT and if data is not transparent.

- **Character Set Detect (CD)**

This restarts the character set recognition logic when changing a character set during a message exchange sequence. First, the terminal operator enters the IVT command: CD = A. Then the operator has 60 seconds to (1) physically change the terminal's code set (for instance, by changing the type element on a typewriter), and (2) activate the TIP's code set recognition sequence by pressing the carriage return key.

- **Echoplex Mode (EP)**

EP specifies where input character echoing will take place. EP=N implies the terminal is doing its own input echoing and EP=Y causes the TIP to set the CLA to provide character echoing.

- **Page Wait (PG)**

PG selects the page wait feature. It allows the user to control output by demanding each page explicitly after the previous page has been viewed for the desired period of time.

- **Abort Output Line Character (AL)**

AL selects the character which, when input followed by a carriage return, will result in the current output line being discarded.

- **User Break 1 (B1)**

B1 selects the character which, when input followed by a carriage return, will cause the TIP to send an upline BRK block with reason code specifying "user break 1". Conventionally user break 1 is used to abort the queue.

- **User Break 2 (B2)**

B2 selects the character which, when input followed by a carriage return, will cause the TIP to send an upline BRK block reason code specifying "user break 2". Conventionally user break 2 is used to abort the job.

**NOTE**

At 2741 terminal, when an operator uses a break 1 or break 2 character, he must precede it by an ATTN character.

- **Message (MS)**

MS defines the character used to delimit messages to the LOP.

## **BATCH TERMINAL FILE CHARACTERISTIC COMMANDS**

In the current release only the BSC and HASP batch terminals can send requests to the host remote batch facility (RBF) to change the operating characteristics of batch files.

A BSC/HASP card reader can change the card punching characteristics (026/029) or the device data mode

(transparent/non-transparent) by entering information in columns 79/80 of a job or EOR card.

- 26 selects 026 mode
- 29 selects 029 mode
- TR selects transparent mode (used on EOR card only; the terminal transparent switch must be on when this card is read)



---

Except for the diagnostics which are described elsewhere, the only operator actions that might be needed at the NPU concern loading the system. Even these actions are needed only in exceptional conditions, since once CCP has been successfully loaded, the host should control all subsequent load operations automatically. Nonetheless, following a failure, it may be desirable to check NPU control switch positions and initiate a CCP load manually.

## LOCAL NPU PROCEDURE

To prepare for a downline load, the NPU operator should perform the following steps:

1. Verify that ports (CLA addresses) to the communications network are correct.
2. On loop multiplexer circuit card, set power (PWR) switch to ON. See figure H-1.
3. On CLA circuit card, set CLA/OFF switches to CLA (on). See figure H-2. Only those cards that are configured are affected.
4. Verify that local console is in normal ON condition.

5. Stop the NPU at the maintenance panel by pressing the MASTER CLEAR switch (figure H-3).

The host discovers that NPU has stopped and initiates the dump and reload sequence.

Upon successful completion of the downline load operation by the host, the host is notified. The host then configures the NPU terminals and normal system operation begins.

If the downline load is unsuccessful, the host initiates and receives a dump of the NPU memory, micromemory checksum, and file 1 registers. The initiation of another downline load attempt is under control of the host.

## REMOTE NPU PROCEDURE

The procedure for the remote NPU is the same as that for the local NPU except for the following:

- Check bootstrap load (SAM-C) tape equipment mounted on NPU cabinet door. The SAM-C tape cassette should be loaded and the ENABLE/DISABLE switch should be set to ENABLE.
- The NPU is downline loaded via a local NPU.

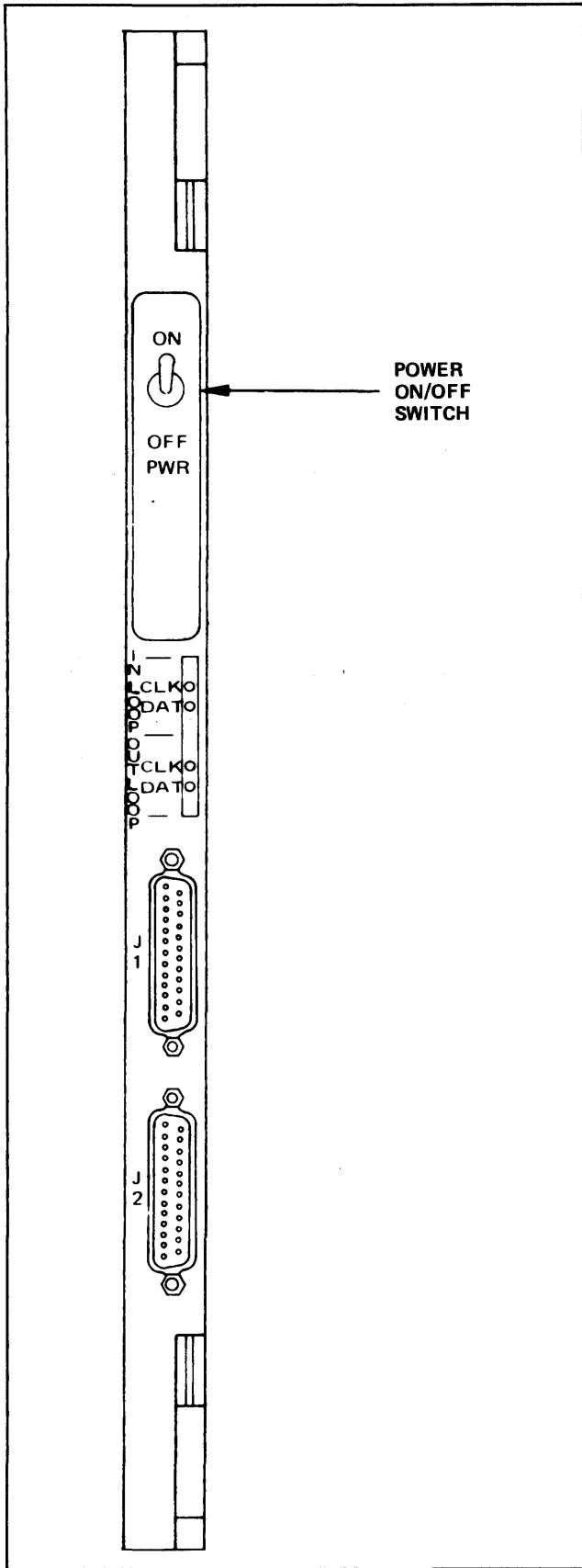

Figure H-1. Loop Multiplexer Circuit Card  
PWR ON/OFF Switch Location

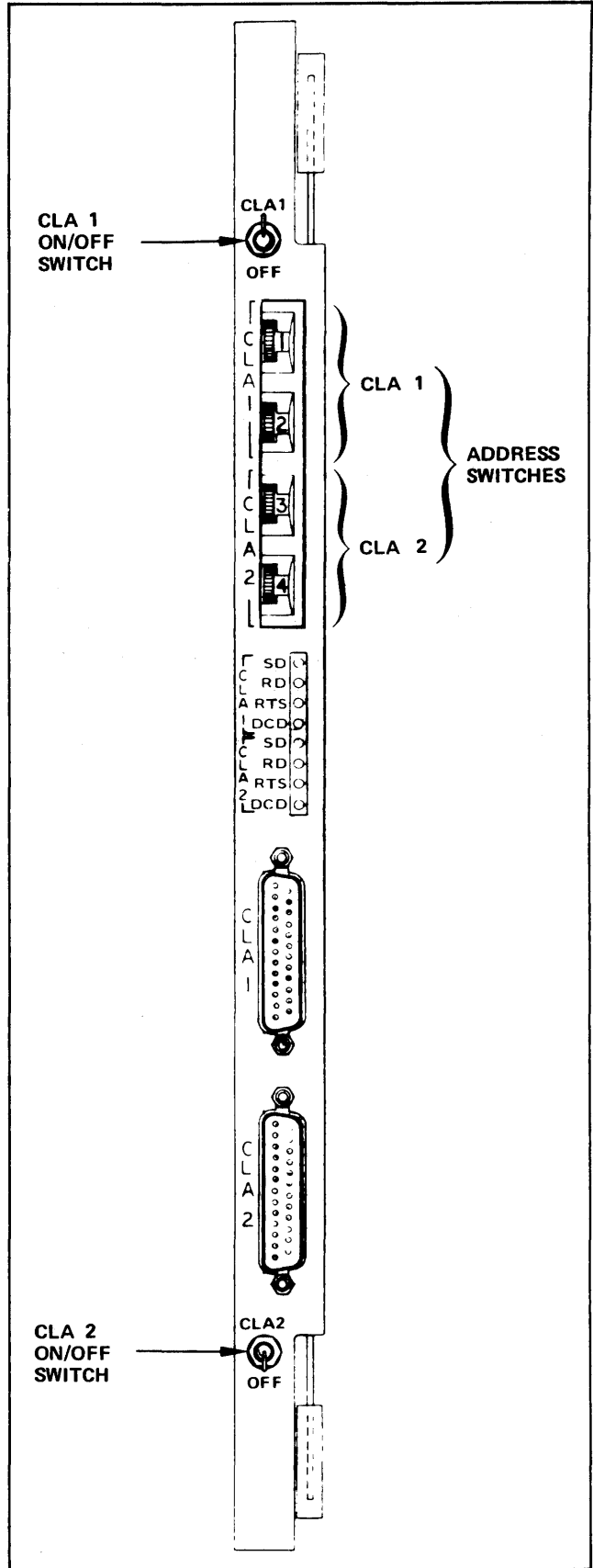

Figure H-2. CLA Circuit Card ON/OFF  
Switch Locations

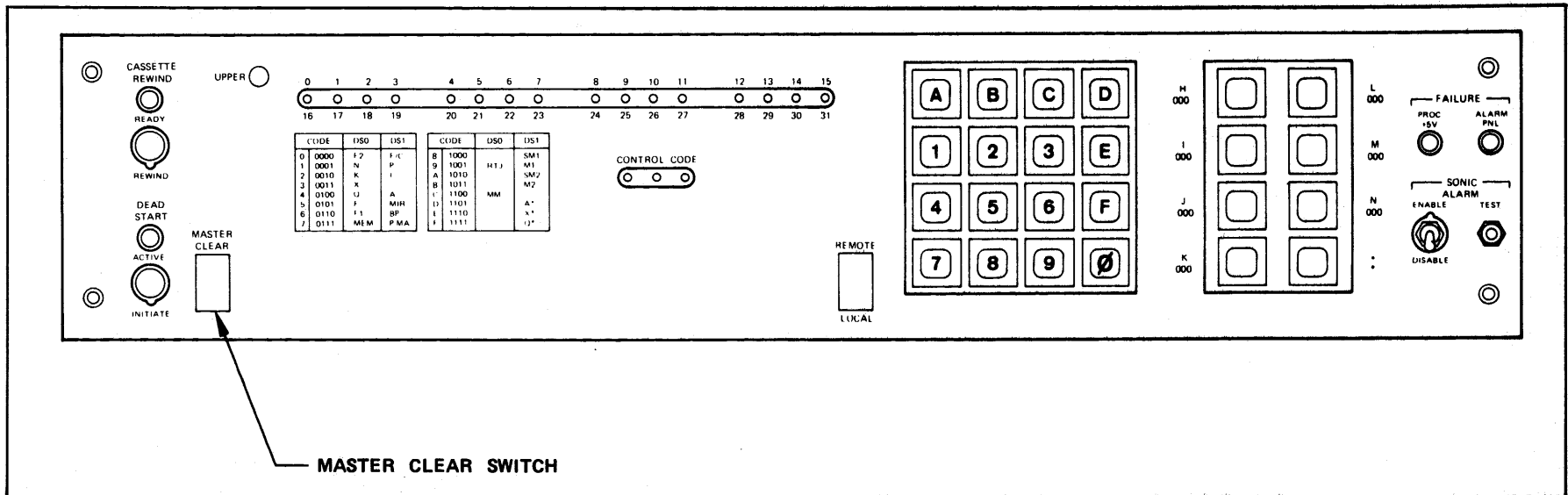

Figure H-3. Maintenance Panel MASTER CLEAR Switch Location .

# INDEX

- Address table B-10
- Alarm messages B-1
- ASCII A-1
- Async TIP 1-13, 2-20
  
- Base system 1-7, 1-10, 2-5
- BIP 2-8
- Block
  - Interface Package (BIP) 2-8
  - PRU 2-2
  - Routing 2-2
- Breakpoint 1-18
- Buffers 2-1, 2-5
  
- Card reader 2-21, 2-23, 2-24, 2-29
- Cassette 1-18, 3-1
- CCP 1-1, 1-6, 1-7
- CCP coding languages 1-7
- CE error messages B-1
- Character sets A-1
- CLA 1-7, 1-19
- Common TIP subroutines 2-9
- Communications
  - Control Program (CCP) 1-1, 1-7
  - Network products 1-6
  - Processor (NPU) 1-17
  - Supervisor (CS) 1-4
- Computer network 1-1
- Configuration 1-19
- Configure NPU 3-7
- Control blocks 2-5
- Control words 2-12
- Coupler 1-19
- CS 1-4
- CYBER Cross Build Utilities 1-16
  
- Data
  - Block 2-28
  - Conversion 2-1, 2-23
  - Downline 2-37
  - Transfer 1-7, 2-18
  - Upline 2-36
- Demultiplexing 2-7
- Diagnostics 1-7, 2-10, 4-1, appendix B
- Direct program calls 2-6
- Dump see Load/dump
  
- Errors 2-28
  
- Failure
  - Host 2-10
  - Line 2-10
  - Logical link 2-10
  - NPU 2-10
  - Terminal 2-10
  - Trunk 2-10
  
- Globals 2-7
  
- HALT codes B-8
- Hardware 1-6, 1-17, 2-4
- HASP 2-27
- HIP 1-11, 2-11
- Host
  - Failure 2-10
  - Interface 1-11, 2-11, 2-22
  - Regulation 2-35
  
- IAF 1-4
- Initialization 2-4, 3-1
- Input
  - Processing 1-7, 2-7, 2-20, 2-22, 2-25, 2-29, 2-31
  - Regulation 2-35
- Interactive Facility (IAF) 1-4
- Interface Packages 2-11
  - Hardware 2-11
  - Software 2-8, 2-10, 2-11
- Interfaces 1-7, 2-3, 2-22
- Internal processing 2-9
- Interrupts 1-18, 2-6
- IVT 1-9, 1-11, 2-19
  
- Languages 1-7, 1-15
- Line failure 2-10
- LIP 1-9, 1-10, 1-12, 2-10, 3-6
- Load/dump
  - Dump format B-12
  - Local NPU 2-11, 3-1
  - Remote NPU 1-13, 2-11, 3-2, 3-6
- Logical link failure 2-10
- Logical link regulation 2-36
- Loop multiplexer 1-18
  
- Macro assembler 1-15, 1-17
- Message
  - Movement 1-7
  - Processing, input 1-7
  - Processing, output 1-8
- Micromemory 1-11, 2-12
- MLIA 1-18
- Mode 4 1-13, 2-21
- Monitor 2-5
- Multiplex Loop Interface Adapter (MLIA) 1-18
- Multiplex subsystem 1-18, 2-7
- Multiplexing
  - Input 1-10, 2-1, 2-7
  - Output 1-10, 2-1, 2-7
  - Trunk 1-10, 2-7
  
- NAM 1-2 thru 1-5
- NDL 1-4
- Network
  - Access Method (NAM) 1-2
  - Communications 1-1
  - Communications software 1-7, 2-8
  - Computer 1-2
  - Concepts 1-1
  - Definition Language (NDL) 1-4
  - Message movement 1-7

Operating System (NOS) 1-2  
Processing 1-9  
Supervisor (NS) 1-4  
NPINTAB B-11  
NPU  
  Configuring 3-7  
  Description 1-1, 1-6, 1-12, 1-17, 2-1  
  Failure 2-10, 4-1  
  Load/dump 2-18, 3-1, 3-6, B-12  
  Memory 1-6, 1-11, 1-17, 1-18  
  Remote 1-12, 2-19  
NS 1-4  
  
ODD 1-10  
Operating procedures H-1  
OPS monitor 2-5  
Output 1-18  
Output processing 1-8, 2-7, 2-21, 2-23, 2-25, 2-29, 2-30

PASCAL 1-15  
PPU 2-11  
Printer 2-24, 2-26  
Priorities 1-12, 2-33  
Program protection 1-18  
Protocol  
  ASYNC 1-13, 2-20  
  Block 2-9  
  BSC 1-13, 2-24  
  HASP 1-14, 2-27  
  Mode 4 1-13, 2-21  
  X.25 1-15, 2-30

Queuing 2-6

RBF 1-4  
Recovery 2-10, 4-1  
Regulation  
  Host 2-35  
  Logical link 2-36  
  Terminal 2-35  
  Trunk 2-35  
Remote Batch Facility (RBF) 1-4  
Routing 2-9

Service module 2-9  
Standard subroutines 2-7  
State programs 1-17  
Statistics message B-6  
Status words 1-12, 2-18  
Switching 2-1  
System monitor 2-5  
  
TAF 1-4  
Terminal  
  Commands H-1  
  Failure 2-10  
  Interface Packages (TIP) 1-13, 2-19  
  Parameters H-1  
  Regulation 2-35  
Terminal Verification Facility (TVF) 1-5  
Timing services 2-6  
TIPs  
  ASYNC 1-13, 2-20  
  BSC 1-13, 2-24  
  Functions 2-12, 2-13, 2-19  
  HASP 1-14, 2-27  
  MODE 4 1-13, 2-21  
  Non-standard 1-15  
  Subroutine (common) 2-9  
  X.25 1-15, 2-30  
Transaction Facility (TAF) 1-4  
Transmission  
  Assurance 2-18  
  Media 2-3  
Trunk  
  Regulation 1-12, 2-19  
  Transmission priorities 1-12, 2-19  
TVF 1-5

UPDATE 1-16  
User interface 2-21

Virtual terminals 2-9

Worklists 2-5

X.25  
  Input sequence 2-30  
  Output sequence 2-30  
  TIP with PAD subTIP 1-15, 2-30

COMMENT SHEET

MANUAL TITLE: Communications Control Program Version 3 Reference Manual

PUBLICATION NO.: 60471400

REVISION: G

NAME:

COMPANY:

STREET ADDRESS:

CITY:

STATE:

ZIP CODE:

This form is not intended to be used as an order blank. Control Data Corporation welcomes your evaluation of this manual. Please indicate any errors, suggested additions or deletions, or general comments below (please include page number references).

Please reply

No reply necessary

NO POSTAGE STAMP NECESSARY IF MAILED IN U.S.A.

FOLD ON DOTTED LINES AND TAPE

TAPE

TAPE

FOLD

FOLD



NO POSTAGE  
NECESSARY  
IF MAILED  
IN THE  
UNITED STATES

**BUSINESS REPLY MAIL**  
FIRST CLASS      PERMIT NO. 8241      MINNEAPOLIS, MINN.

POSTAGE WILL BE PAID BY

**CONTROL DATA CORPORATION**

Publications and Graphics Division

215 Moffett Park Drive  
Sunnyvale, California 94086



CUT ALONG LINE

FOLD

FOLD

CORPORATE HEADQUARTERS, P.O. BOX 0, MINNEAPOLIS, MINN. 55440  
SALES OFFICES AND SERVICE CENTERS IN MAJOR CITIES THROUGHOUT THE WORLD

LITHO IN U.S.A.



**CONTROL DATA CORPORATION**