

# KMC11-B General Purpose Microprocessor User Guide

# **KMC11-B General Purpose Microprocessor User Guide**

**Prepared by Educational Services  
of  
Digital Equipment Corporation**

© Digital Equipment Corporation 1983  
All Rights Reserved

The information in this document is subject to change without notice and should not be construed as a commitment by Digital Equipment Corporation. Digital Equipment Corporation assumes no responsibility for any errors that may appear in this document.

Printed in U.S.A.

This document was set on DIGITAL's DECset Integrated Publishing System.

The following are trademarks of Digital Equipment Corporation:

**digital**™

DEC

DECmate

DECset

DECsystem-10

DECSYSTEM-20

DECUS

DECwriter

DIBOL

KMC

KMS

MASSBUS

PDP

P/OS

Professional

Rainbow

RSTS

RSX

UNIBUS

VAX

VMS

VT

Work Processor

# CONTENTS

		Page
<b>PREFACE</b>		
<b>CHAPTER 1 INTRODUCTION</b>		
1.1	INTRODUCTION .....	1-1
1.2	PHYSICAL DESCRIPTION .....	1-1
1.3	FUNCTIONAL DESCRIPTION .....	1-1
1.4	GENERAL SPECIFICATIONS .....	1-1
1.4.1	Mechanical Specifications .....	1-1
1.4.2	Operational Environment Specifications .....	1-2
1.4.3	Electrical Specifications .....	1-2
1.4.4	UNIBUS Conductor Specifications .....	1-2
1.5	GENERAL PARAMETERS .....	1-2
<b>CHAPTER 2 SITE PREPARATION AND INSTALLATION</b>		
2.1	INTRODUCTION .....	2-1
2.2	PHYSICAL AND OPERATIONAL ENVIRONMENTS .....	2-1
2.2.1	Physical Environment .....	2-1
2.2.2	Operational Environment .....	2-2
2.3	KMC11-B MICROPROCESSOR INSTALLATION .....	2-2
2.3.1	KMC11-B (M8206 - Etch Rev C) UNIBUS Microprocessor .....	2-2
2.3.2	KMC11-B (M8206 - Etch Rev D) UNIBUS Microprocessor .....	2-6
2.3.3	KMC11-B (M8206 - Etch Rev E) UNIBUS Microprocessor .....	2-10
<b>CHAPTER 3 PROGRAMMING</b>		
3.1	INTRODUCTION .....	3-1
3.2	MOVE INSTRUCTIONS .....	3-1
3.3	BRANCH INSTRUCTIONS .....	3-3
<b>CHAPTER 4 MAINTENANCE</b>		
4.1	INTRODUCTION .....	4-1
4.2	MAINTENANCE PHILOSOPHY .....	4-1
4.3	SPECIAL TOOLS AND EQUIPMENT .....	4-1
4.4	DIAGNOSTIC SOFTWARE .....	4-1
4.5	PDP-11 FAMILY DIAGNOSTICS .....	4-1
4.6	VAX-11 FAMILY DIAGNOSTICS .....	4-1
4.7	PREVENTIVE MAINTENANCE .....	4-3
4.8	DIAGNOSTIC LISTINGS .....	4-3

## FIGURES

Figure No.	Title	Page
2-1	KMC11-B Microprocessor Placement in a Nine-Slot Expansion Box .....	2-1
2-2	KMC11-B (M8206 – Etch Rev C) UNIBUS Microprocessor Board .....	2-3
2-3	KMC11-B (M8206 – Etch Rev C) UNIBUS Microprocessor Address Selection Switch E125.....	2-3
2-4	KMC11-B (M8206 – Etch Rev C) UNIBUS Microprocessor Vector Selection Switch E27.....	2-3
2-5	DD11-DK Nine-Slot Backplane with KMC11-B Board Locations (Viewed from the Backplane Pin-Side).....	2-6
2-6	KMC11-B (M8206 – Etch Rev D) UNIBUS Microprocessor Board .....	2-7
2-7	KMC11-B (M8206 – Etch Rev D) UNIBUS Microprocessor Address Selection Switch E129.....	2-7
2-8	KMC11-B (M8206 – Etch Rev D) UNIBUS Microprocessor Vector Selection Switch E31.....	2-7
2-9	DD11-DR Nine-Slot Backplane with KMC11-B Board Locations (Viewed from the Backplane Pin-Side).....	2-10
2-10	KMC11-B (M8206 – Etch Rev E) UNIBUS Microprocessor Board .....	2-11
2-11	KMC11-B (M8206 – Etch Rev E) UNIBUS Microprocessor Address Selection Switch E129.....	2-11
2-12	KMC11-B (M8206 – Etch Rev E) UNIBUS Microprocessor Vector Selection Switch E31.....	2-11
2-13	KMC11-B (M8206 – Etch Rev E) UNIBUS Microprocessor Programmer Timer Selection Switch E82.....	2-14
2-14	DD11-DR Nine-Slot Backplane with KMC11-B Board Locations (Viewed from the Backplane Pin-Side).....	2-14
3-1	Move Instruction Word Format.....	3-1
3-2	Move Instruction Set Summary .....	3-2
3-3	Branch Instruction Word Format.....	3-3
3-4	Branch Instruction Set Summary.....	3-4
4-1	KMC11-B Diagnostic Flowchart.....	4-2

## TABLES

Table No.	Title	Page
2-1	KMC11-B (M8206 – Etch Rev C) UNIBUS Microprocessor Address Selection Switch E125 Settings .....	2-4
2-2	KMC11-B (M8206 – Etch Rev C) UNIBUS Microprocessor Vector Selection Switch E27 Settings .....	2-5
2-3	KMC11-B (M8206 – Etch Rev D) UNIBUS Microprocessor Address Selection Switch E129 Settings .....	2-8
2-4	KMC11-B (M8206 – Etch Rev D) UNIBUS Microprocessor Vector Selection Switch E31 Settings.....	2-9
2-5	KMC11-B (M8206 – Etch Rev E) UNIBUS Microprocessor Address Selection Switch E129 Settings .....	2-12
2-6	KMC11-B (M8206 – Etch Rev E) UNIBUS Microprocessor Vector Selection Switch E31 Settings .....	2-13

## PREFACE

The *KMC11-B General Purpose Microprocessor User Guide* contains technical information that gives a basic description of the specifications and features of the KMC11-B general purpose microprocessor. Additional information about the KMC11-B general purpose microprocessor can be found in the manuals listed below:

- *KMC11-B UNIBUS Microprocessor Option Description* (YM-C093C-00)
- *KMC11-B Programmer's Manual* (YM-P093C-00)
- *KMC11 General Purpose Microprocessor User's Manual* (EK-KMC11-OP-001)
- *KMC11 General Purpose Microprocessor Maintenance Manual* (EK-KMC11-MM-001)



# CHAPTER 1 INTRODUCTION

## 1.1 INTRODUCTION

This chapter gives a physical description, functional description, and the general specifications of the KMC11-B general purpose microprocessor that is used on systems that have a UNIBUS conductor.

## 1.2 PHYSICAL DESCRIPTION

The KMC11-B general purpose microprocessor is a hex-height, multilayer module. The microprocessor plugs into any DD11-C or DD11-D small peripheral controller (SPC) system or equivalent backplane.

## 1.3 FUNCTIONAL DESCRIPTION

The KMC11-B general purpose microprocessor is an auxiliary processor unit that provides UNIBUS conductor interface and connection to line termination units. The microprocessor operates in parallel with the main computer and is specifically suited to data movement, character processing, address arithmetic, and other functions necessary for controlling I/O devices, formatting data, and processing communications protocols. The KMC11-B microprocessor can be used in conjunction with all UNIBUS conductor based PDP-11 processors.

The functions performed by the KMC11-B microprocessor are determined, for the most part, by the microprogram in the microprocessor control memory. This control memory is volatile and may be changed whenever desired by the PDP-11 processor. In normal operation, the PDP-11 operating system loads the microprogram into the KMC11-B microprocessor control memory as part of system initialization. The microprogram remains in the control memory until the system is reinitialized.

Since different applications require different types of microcode/software interfaces, the microprogram for the KMC11-B microprocessor must be tailored to the specific application being performed. For additional information on KMC11-B microprocessor programming, refer to the *KMC11-B Programmer's Manual* (YM-P093C-00).

## 1.4 GENERAL SPECIFICATIONS

General specifications\* for the KMC11-B microprocessor are broken into the following categories:

- Mechanical specifications,
- Operational environment specifications,
- Electrical specifications, and
- UNIBUS conductor specifications.

### 1.4.1 Mechanical Specifications

#### Mounting Requirements:

The KMC11-B mounts into any DD11-C or DD11-D SPC system or equivalent backplane. Space to accommodate a hex-height, extended-length, single-width module with extractor bracket is needed.

---

\* Specifications are subject to change without notice.



### 1.4.2 Operational Environment Specifications

Temperature:	10°C to 40°C (50°F to 104°F)
Relative Humidity:	10% to 90%
Maximum Wet Bulb:	28°C (82°F)
Minimum Dew Point:	2°C (36°F)

### 1.4.3 Electrical Specifications

Logic:	Transistor-transistor logic (TTL)
Power (Maximum):	+5 Vdc @ 7.9 A

### 1.4.4 UNIBUS Conductor Specifications

UNIBUS Conductor Loads	4 ac unit loads 1 dc unit load
Addresses	764100 - 764106 (typical)
Vectors	310 - 314 (typical)
Interrupt Levels	BR5, nonprocessor request (NPR)

#### NOTE

Addresses and vectors are switch selectable within the floating or user address and vector space. (For switchpack settings refer to Chapter 2.)

## 1.5 GENERAL PARAMETERS

### Instruction Timing

Move (Nonmultiport)	180 ns
Branch Not True	180 ns
Move Multiport	210 ns
Branch True	240 ns
Data Memory	4K bytes
Control Random Access Memory (RAM)	4K words
Scratch Pad	16 bytes
Instruction Length	16 bits
Data Path	8 bits
NPR Address	18 bits
Interrupt Vectors	2

<b>CSR (RAM) Microcode Defined</b>	<b>7 bytes</b>
<b>Arithmetic Logic Unit (ALU) Functions</b>	<b>16</b>
<b>NPR Data Transfers</b>	<b>Byte or word</b>
<b>Control Status Register (CSR) Transfers</b>	<b>Byte or word</b>
<b>Program Timer</b>	<b>75 <math>\mu</math>s or 115 ms (switch selectable on latest version)</b>
<b>Module Size</b>	<b>Hex-height, extended-length, single-width</b>



## CHAPTER 2 SITE PREPARATION AND INSTALLATION

### 2.1 INTRODUCTION

This chapter describes the installation, setup, and configuration for the KMC11-B general purpose microprocessor. It also describes the three revision levels for the KMC11-B microprocessor (Etch Rev C, D, and E).

### 2.2 PHYSICAL AND OPERATIONAL ENVIRONMENTS

#### 2.2.1 Physical Environment

The KMC11-B general purpose microprocessor requires adequate space in the BA11-K nine-slot expander box. (Refer to Figure 2-1 for the proper placement of the KMC11-B microprocessor module.)

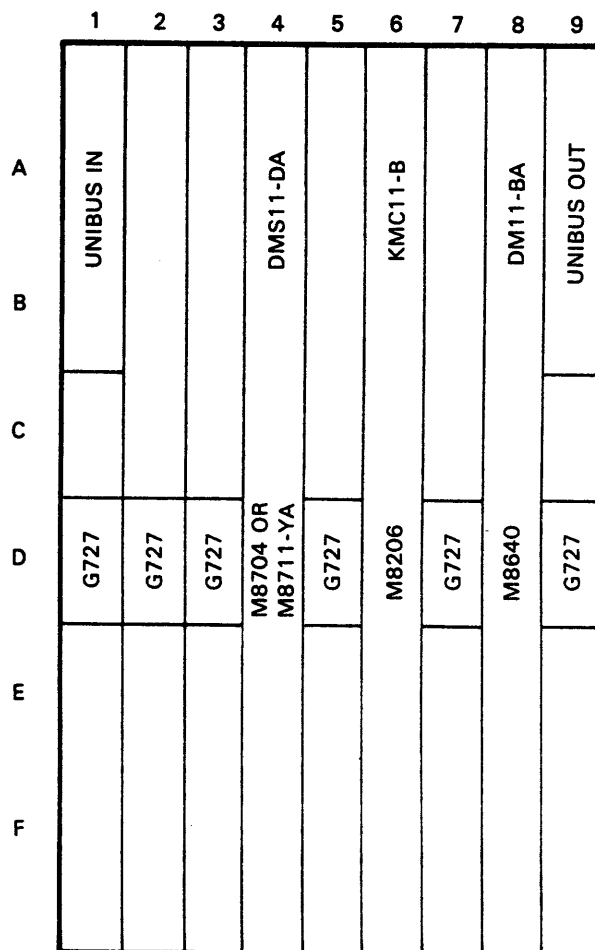

MK-3332

Figure 2-1 KMC11-B Microprocessor Placement  
in a Nine-Slot Expansion Box

Careful grounding is essential in order to avoid ground loops and poor noise rejection. To eliminate ground loops and have proper noise rejection, ensure that:

- The KMC11-B microprocessor and all equipment that it connects to share a common ac power source.
- No electrically noisy equipment shares the same power source.

### 2.2.2 Operational Environment

The KMC11-B microprocessor is designed to operate in a "Class B" environment. A "Class B" environment meets the following prerequisites:

- Temperature – 10°C to 40°C (50°F to 104°F)
- Relative humidity – 10% to 90%
- Maximum wet bulb – 28°C (82°F)
- Minimum dew point – 2°C (36°F)

### 2.3 KMC11-B MICROPROCESSOR INSTALLATION

This section covers the installation and setup of the three revision levels of the KMC11-B microprocessor.

The boards are listed numerically by the printed circuit board part number and revision level. Following the printed circuit board number, the option nomenclature is listed. For example:

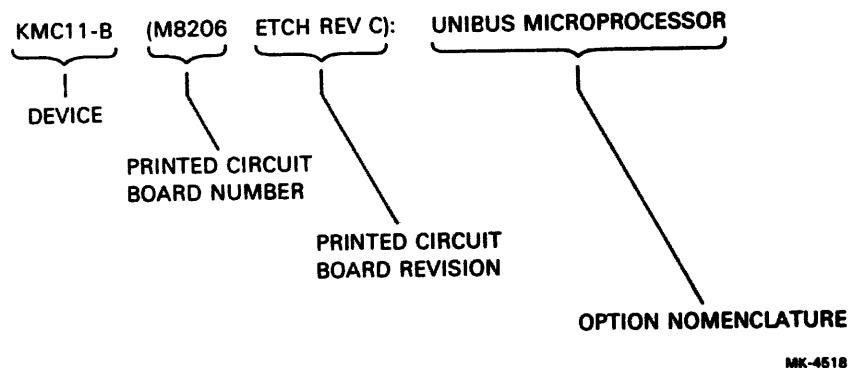

#### 2.3.1 KMC11-B (M8206 – Etch Rev C) UNIBUS Microprocessor

To install the KMC11-B (M8206 – Etch Rev C) general purpose UNIBUS microprocessor, perform the following:

1. Ensure that the priority plug (level 5) is properly inserted into its socket.
2. Ensure that jumper W1 (Figure 2-2) is installed.

#### NOTE

**Jumper W1 should not be removed. It is removed only during module testing at the factory.**

3. Set the E125 switchpack switches (Figure 2-3) so that the module will respond to its assigned address. (Refer to Table 2-1 for address switch settings.)
4. Set the E27 switchpack switches (Figure 2-4) to the proper vector selection. (Refer to Table 2-2 for vector switch settings.)

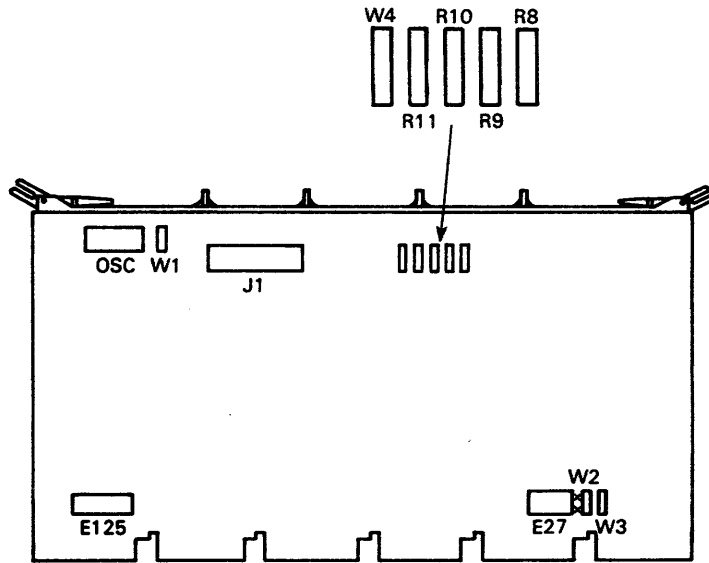

E27 = ADDRESS SELECT (10-POSITION SWITCH)  
 E125 = VECTOR SELECT (7-POSITION SWITCH)

**NOTE**

E27 MAY BE 10 POSITIONS. IF SO E27-9 REPLACES W2 AND  
 E27-10 REPLACES W3.

- W1 = ALWAYS IN
- W2 = ALWAYS IN
- W3 = NORMALLY IN (ALLOWS KMC11-B MICROPROCESSOR CONTROL OF AC LO)
- W4 = ALWAYS IN (ECO NU006)

MK-3333

Figure 2-2 KMC11-B (M8206 - Etch Rev C) UNIBUS Microprocessor Board

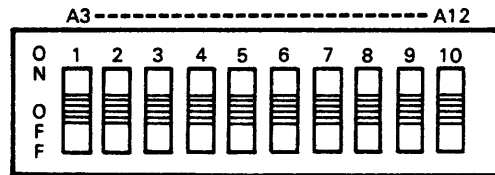

MK-3343

Figure 2-3 KMC11-B (M8206 - Etch Rev C) UNIBUS  
 Microprocessor Address Selection Switch E125

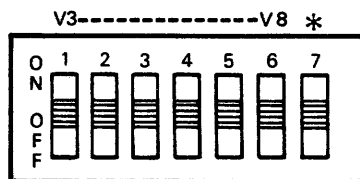

\* S7 (NOT USED)

MK-3344

Figure 2-4 KMC11-B (M8206 - Etch Rev C) UNIBUS  
 Microprocessor Vector Selection Switch E27

**Table 2-1 KMC11-B (M8206 - Etch Rev C) UNIBUS Microprocessor  
Address Selection Switch E125 Settings**

Address	E125 Switch Settings									
	S1 (A3)	S2 (A4)	S3 (A5)	S4 (A6)	S5 (A7)	S6 (A8)	S7 (A9)	S8 (A10)	S9 (A11)	S10 (A12)
760000	ON	ON	ON	ON	ON	ON	ON	ON	ON	ON
760010	OFF	ON	ON	ON	ON	ON	ON	ON	ON	ON
760020	ON	OFF	ON	ON	ON	ON	ON	ON	ON	ON
760030	OFF	OFF	ON	ON	ON	ON	ON	ON	ON	ON
760040	ON	ON	OFF	ON	ON	ON	ON	ON	ON	ON
760050	OFF	ON	OFF	ON	ON	ON	ON	ON	ON	ON
760060	ON	OFF	OFF	ON	ON	ON	ON	ON	ON	ON
760070	OFF	OFF	OFF	ON	ON	ON	ON	ON	ON	ON
760100	ON	ON	ON	OFF	ON	ON	ON	ON	ON	ON
- 760200	ON	ON	ON	ON	OFF	ON	ON	ON	ON	ON
- 760300	ON	ON	ON	OFF	OFF	ON	ON	ON	ON	ON
- 760400	ON	ON	ON	ON	ON	OFF	ON	ON	ON	ON
- 760500	ON	ON	ON	OFF	ON	OFF	ON	ON	ON	ON
- 760600	ON	ON	ON	ON	OFF	OFF	ON	ON	ON	ON
- 760700	ON	ON	ON	OFF	OFF	OFF	ON	ON	ON	ON
- 761000	ON	ON	ON	ON	ON	ON	OFF	ON	ON	ON
- 762000	ON	ON	ON	ON	ON	ON	ON	OFF	ON	ON
- 763000	ON	ON	ON	ON	ON	ON	OFF	OFF	ON	ON
- 764000	ON	ON	ON	ON	ON	ON	ON	ON	OFF	ON
- 765000	ON	ON	ON	ON	ON	ON	OFF	ON	OFF	ON
- 766000	ON	ON	ON	ON	ON	ON	ON	OFF	OFF	ON
- 767000	ON	ON	ON	ON	ON	ON	OFF	OFF	OFF	ON
- 770000	ON	ON	ON	ON	ON	ON	ON	ON	ON	OFF
- 777770	OFF	OFF	OFF	OFF	OFF	OFF	OFF	OFF	OFF	OFF

**Table 2-2 KMC11-B (M8206 – Etch Rev C) UNIBUS Microprocessor  
Vector Selection Switch E27 Settings**

Vector	E27 Switch Settings						
	S1 (V3)	S2 (V4)	S3 (V5)	S4 (V6)	S5 (V7)	S6 (V8)	S7 (Not Used)
300	OFF	OFF	OFF	ON	ON	OFF	
310	ON	OFF	OFF	ON	ON	OFF	
320	OFF	ON	OFF	ON	ON	OFF	
330	ON	ON	OFF	ON	ON	OFF	
340	OFF	OFF	ON	ON	ON	OFF	
350	ON	OFF	ON	ON	ON	OFF	
360	OFF	ON	ON	ON	ON	OFF	
370	ON	ON	ON	ON	ON	OFF	
400	OFF	OFF	OFF	OFF	OFF	ON	
- 500	OFF	OFF	OFF	ON	OFF	ON	
- 600	OFF	OFF	OFF	OFF	ON	ON	
- 700	OFF	OFF	OFF	ON	ON	ON	

5. Ensure that jumper W2 (Figure 2-2) is installed at all times.

**NOTE**

**Jumper W2 should not be removed. It is removed only during module testing at the factory.**

6. Ensure that jumper W3 (Figure 2-2) is installed.

**NOTE**

**Jumper W3 should only be removed if the KMC11-B microprocessor control of AC LO is inhibited.**

7. Install the M8206 (Etch Rev C) in the appropriate location in the DD11-DK nine-slot backplane (Figure 2-5).

**NOTE**

**Ensure that the nonprocessor request (NPR) grant continuity wire between pins CA1 and CB1 of the backplane is removed from the location in which the M8206 is being installed.**



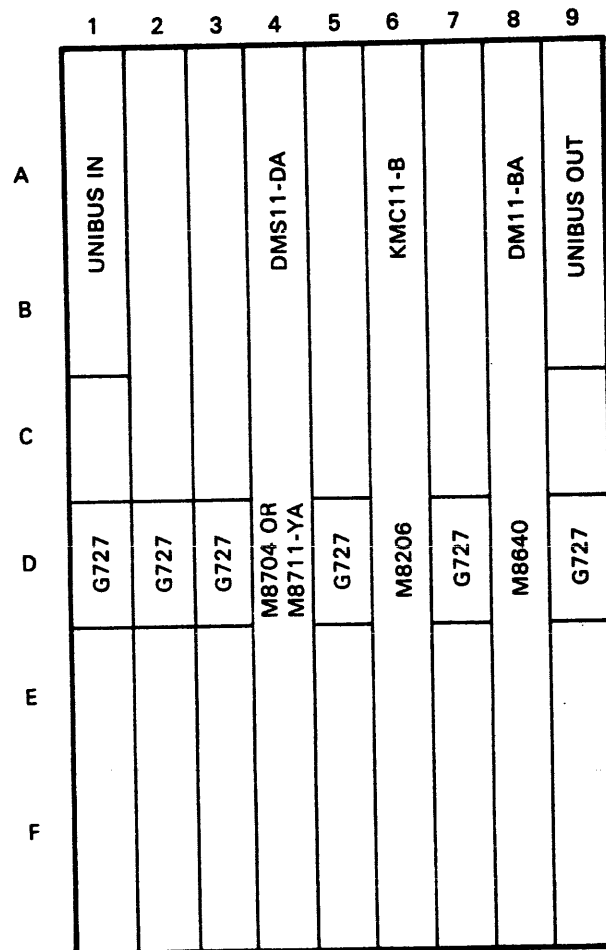

MK-3332

Figure 2-5 DD11-DK Nine-Slot Backplane with KMC11-B Board Locations (Viewed from the Backplane Pin-Side)

### 2.3.2 KMC11-B (M8206 – Etch Rev D) UNIBUS Microprocessor

To install the KMC11-B (M8206 – Etch Rev D) general purpose UNIBUS microprocessor, perform the following:

1. Ensure that the priority plug (level 5) is properly inserted into its socket.
2. Ensure that jumper W1 (Figure 2-6) is installed.

**NOTE**

**Jumper W1 should not be removed. It is removed only during module testing at the factory.**

3. Set the E129 switchpack switches (Figure 2-7) so that the module will respond to its assigned address. (Refer to Table 2-3 for address switch settings.)
4. Set the E31 switchpack switches (Figure 2-8) to the proper vector selection. (Refer to Table 2-4 for vector switch settings.)

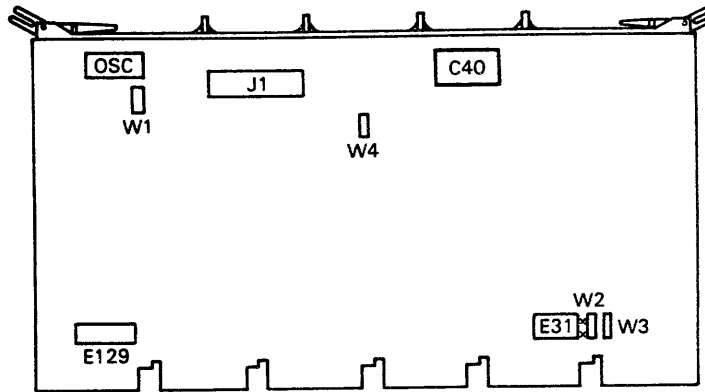

E31 = VECTOR SELECT (7-POSITION SWITCH)  
 E129 = ADDRESS SELECT (10-POSITION SWITCH)

**NOTE**

E31 MAY BE 10 POSITIONS. IF SO E31-9  
 REPLACES W2 AND E31-10 REPLACES W3.

W1 = ALWAYS IN

W2 = ALWAYS IN

W3 = NORMALLY IN (ALLOWS KMC11-B MICROPROCESSOR CONTROL OF AC LO)

W4 = ALWAYS IN (ECO NU006)

C40 = AT PRESENT THE TIMER VALUES REQUIRED FOR  
 KNOWN SOFTWARE IS AS FOLLOWS:

- DDCMP (CSS)            EITHER
- X.25 (CSS)            115 MS
- ADDCP (CSS)           115 MS
- BX.25 (BELL)          76  $\mu$ s

**NOTE**

WHEN C40 = 10  $\mu$ f 20 V, TIMEOUT = 115 MS

WHEN C40 = 4700 pf 100 V, TIMEOUT = 75  $\mu$ s

MK-3334

Figure 2-6 KMC11-B (M8206 - Etch Rev D) UNIBUS Microprocessor Board

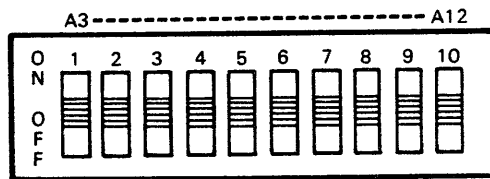

MK-3342

Figure 2-7 KMC11-B (M8206 - Etch Rev D) UNIBUS  
 Microprocessor Address Selection Switch E129

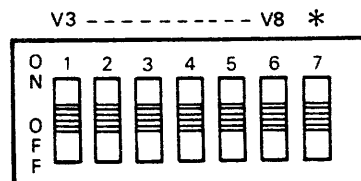

\* S7 NOT USED

MK-3338

Figure 2-8 KMC11-B (M8206 - Etch Rev D) UNIBUS  
 Microprocessor Vector Selection Switch E31

**Table 2-3 KMC11-B (M8206 – Etch Rev D) UNIBUS Microprocessor  
Address Selection Switch E129 Settings**

Address	E129 Switch Settings									
	S1 (A3)	S2 (A4)	S3 (A5)	S4 (A6)	S5 (A7)	S6 (A8)	S7 (A9)	S8 (A10)	S9 (A11)	S10 (A12)
760000	ON	ON	ON	ON	ON	ON	ON	ON	ON	ON
760010	OFF	ON	ON	ON	ON	ON	ON	ON	ON	ON
760020	ON	OFF	ON	ON	ON	ON	ON	ON	ON	ON
760030	OFF	OFF	ON	ON	ON	ON	ON	ON	ON	ON
760040	ON	ON	OFF	ON	ON	ON	ON	ON	ON	ON
760050	OFF	ON	OFF	ON	ON	ON	ON	ON	ON	ON
760060	ON	OFF	OFF	ON	ON	ON	ON	ON	ON	ON
760070	OFF	OFF	OFF	ON	ON	ON	ON	ON	ON	ON
760100	ON	ON	ON	OFF	ON	ON	ON	ON	ON	ON
-										
760200	ON	ON	ON	ON	OFF	ON	ON	ON	ON	ON
-										
760300	ON	ON	ON	OFF	OFF	ON	ON	ON	ON	ON
-										
760400	ON	ON	ON	ON	ON	OFF	ON	ON	ON	ON
-										
760500	ON	ON	ON	OFF	ON	OFF	ON	ON	ON	ON
-										
760600	ON	ON	ON	ON	OFF	OFF	ON	ON	ON	ON
-										
760700	ON	ON	ON	OFF	OFF	OFF	ON	ON	ON	ON
-										
761000	ON	ON	ON	ON	ON	ON	OFF	ON	ON	ON
-										
762000	ON	ON	ON	ON	ON	ON	ON	OFF	ON	ON
-										
763000	ON	ON	ON	ON	ON	ON	OFF	OFF	ON	ON
-										
764000	ON	ON	ON	ON	ON	ON	ON	ON	OFF	ON
-										
765000	ON	ON	ON	ON	ON	ON	OFF	ON	OFF	ON
-										
766000	ON	ON	ON	ON	ON	ON	ON	OFF	OFF	ON
-										
767000	ON	ON	ON	ON	ON	ON	OFF	OFF	OFF	ON
-										
770000	ON	ON	ON	ON	ON	ON	ON	ON	ON	OFF
-										
777770	OFF	OFF	OFF	OFF	OFF	OFF	OFF	OFF	OFF	OFF

**Table 2-4 KMC11-B (M8206 – Etch Rev D) UNIBUS Microprocessor  
Vector Selection Switch E31 Settings**

Vector	E31 Switch Settings						
	S1 (V3)	S2 (V4)	S3 (V5)	S4 (V6)	S5 (V7)	S6 (V8)	S7 (Not Used)
300	OFF	OFF	OFF	ON	ON	OFF	
310	ON	OFF	OFF	ON	ON	OFF	
320	OFF	ON	OFF	ON	ON	OFF	
330	ON	ON	OFF	ON	ON	OFF	
340	OFF	OFF	ON	ON	ON	OFF	
350	ON	OFF	ON	ON	ON	OFF	
360	OFF	ON	ON	ON	ON	OFF	
370	ON	ON	ON	ON	ON	OFF	
400	OFF	OFF	OFF	OFF	OFF	ON	
- 500	OFF	OFF	OFF	ON	OFF	ON	
- 600	OFF	OFF	OFF	OFF	ON	ON	
- 700	OFF	OFF	OFF	ON	ON	ON	

5. Ensure that jumper W2 (Figure 2-6) is installed at all times.

**NOTE**

**Jumper W2 should not be removed. It is removed only during module testing at the factory.**

6. Ensure that jumper W3 (Figure 2-6) is installed.

**NOTE**

**Jumper W3 should only be removed if the KMC11-B microprocessor control of AC LO is inhibited.**

7. Install the M8206 (Etch Rev D) in the DD11-DK nine-slot backplane (Figure 2-9).

**NOTE**

**Ensure that the nonprocessor request (NPR) grant continuity wire between pins CA1 and CB1 of the backplane is removed from the location in which the M8206 is being installed.**

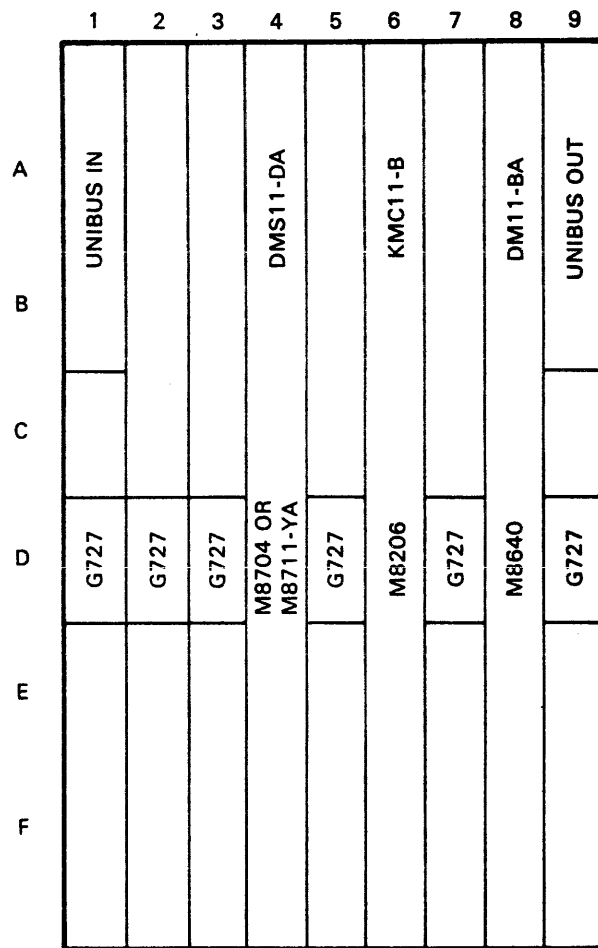

MK-3332

Figure 2-9 DD11-DK Nine-Slot Backplane with KMC11-B Board Locations (Viewed from the Backplane Pin-Side)

### 2.3.3 KMC11-B (M8206 – Etch Revision E) UNIBUS Microprocessor

To install the KMC11-B (M8206 – Etch Rev E) general purpose UNIBUS microprocessor, perform the following:

1. Ensure that the priority plug (level 5) is properly inserted into its socket.
2. Ensure that jumper W1 (Figure 2-10) is installed.

**NOTE**

**Jumper W1 should not be removed. It is removed only during module testing at the factory.**

3. Set the E129 switchpack switches (Figure 2-11) so that the module will respond to its assigned address. (Refer to Table 2-5 for address switch settings.)
4. Set the E31 switchpack switches (Figure 2-12) to the proper vector selection. (Refer to Table 2-6 for vector switch settings.)

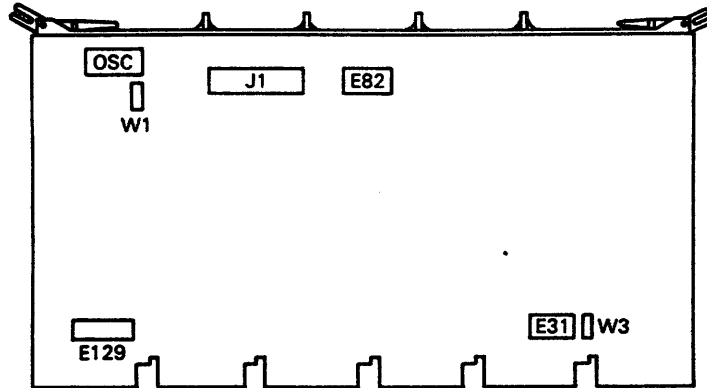

- E31 = VECTOR SELECT (7-POSITION SWITCH)
- E82-8 = PROGRAM TIMER SELECT (8-POSITION SWITCH)
- E129 = ADDRESS SELECT (10-POSITION SWITCH)
- W1 = ALWAYS IN
- W3 = NORMALLY IN (OFF TO DISABLE KMC11-B CONTROL OF AC LO)

MK-3335

Figure 2-10 KMC11-B (M8206 - Etch Rev E) UNIBUS Microprocessor Board

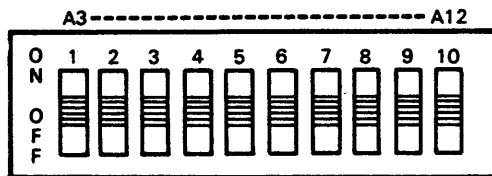

MK-3340

Figure 2-11 KMC11-B (M8206 - Etch Rev E) UNIBUS Microprocessor Address Selection Switch E129

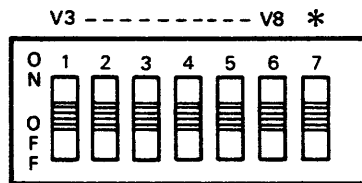

\* S7 NOT USED

MK-3338

Figure 2-12 KMC11-B (M8206 - Etch Rev E) UNIBUS Microprocessor Vector Selection Switch E31

**Table 2-5 KMC11-B (M8206 – Etch Rev E) UNIBUS Microprocessor  
Address Selection Switch E129 Settings**

Address	E129 Switch Settings									
	S1 (A3)	S2 (A4)	S3 (A5)	S4 (A6)	S5 (A7)	S6 (A8)	S7 (A9)	S8 (A10)	S9 (A11)	S10 (A12)
760000	ON	ON	ON	ON	ON	ON	ON	ON	ON	ON
760010	OFF	ON	ON	ON	ON	ON	ON	ON	ON	ON
760020	ON	OFF	ON	ON	ON	ON	ON	ON	ON	ON
760030	OFF	OFF	ON	ON	ON	ON	ON	ON	ON	ON
760040	ON	ON	OFF	ON	ON	ON	ON	ON	ON	ON
760050	OFF	ON	OFF	ON	ON	ON	ON	ON	ON	ON
760060	ON	OFF	OFF	ON	ON	ON	ON	ON	ON	ON
760070	OFF	OFF	OFF	ON	ON	ON	ON	ON	ON	ON
760100	ON	ON	ON	OFF	ON	ON	ON	ON	ON	ON
-										
760200	ON	ON	ON	ON	OFF	ON	ON	ON	ON	ON
-										
760300	ON	ON	ON	OFF	OFF	ON	ON	ON	ON	ON
-										
760400	ON	ON	ON	ON	ON	OFF	ON	ON	ON	ON
-										
760500	ON	ON	ON	OFF	ON	OFF	ON	ON	ON	ON
-										
760600	ON	ON	ON	ON	OFF	OFF	ON	ON	ON	ON
-										
760700	ON	ON	ON	OFF	OFF	OFF	ON	ON	ON	ON
-										
761000	ON	ON	ON	ON	ON	ON	OFF	ON	ON	ON
-										
762000	ON	ON	ON	ON	ON	ON	ON	OFF	ON	ON
-										
763000	ON	ON	ON	ON	ON	ON	OFF	OFF	ON	ON
-										
764000	ON	ON	ON	ON	ON	ON	ON	ON	OFF	ON
-										
765000	ON	ON	ON	ON	ON	ON	OFF	ON	OFF	ON
-										
766000	ON	ON	ON	ON	ON	ON	ON	OFF	OFF	ON
-										
767000	ON	ON	ON	ON	ON	ON	OFF	OFF	OFF	ON
-										
770000	ON	ON	ON	ON	ON	ON	ON	ON	ON	OFF
-										
777770	OFF	OFF	OFF	OFF	OFF	OFF	OFF	OFF	OFF	OFF

**Table 2-6 KMC11-B (M8206 – Etch Rev E) UNIBUS Microprocessor  
Vector Selection Switch E31 Settings**

Vector	E31 Switch Settings						
	S1 (V3)	S2 (V4)	S3 (V5)	S4 (V6)	S5 (V7)	S6 (V8)	S7 (Not Used)
300	OFF	OFF	OFF	ON	ON	OFF	
310	ON	OFF	OFF	ON	ON	OFF	
320	OFF	ON	OFF	ON	ON	OFF	
330	ON	ON	OFF	ON	ON	OFF	
340	OFF	OFF	ON	ON	ON	OFF	
350	ON	OFF	ON	ON	ON	OFF	
360	OFF	ON	ON	ON	ON	OFF	
370	ON	ON	ON	ON	ON	OFF	
400	OFF	OFF	OFF	OFF	OFF	ON	
- 500	OFF	OFF	OFF	ON	OFF	ON	
- 600	OFF	OFF	OFF	OFF	ON	ON	
- 700	OFF	OFF	OFF	ON	ON	ON	

5. Ensure that jumper W3 (Figure 2-10) is installed.

**NOTE**

**Jumper W3 should only be removed if the KMC11-B microprocessor control of AC LO is inhibited.**

6. Set the E82-8 switchpack switches (Figure 2-13) for the proper timeout value.

**NOTE**

**When switchpack E82-8 is ON, a timeout value of 115 milliseconds is provided. When switchpack E82-8 is OFF, a timeout value of 75 microseconds is provided.**

**At present, the timeout values required for known software are as follows:**

DDCMP (CSS)	Either
X.25 (CSS)	115 ms
ADDCP (CSS)	115 ms
BX.25 (Bell)	75 $\mu$ s



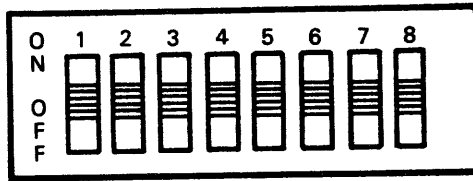

MK-3348

Figure 2-13 KMC11-B (M8206 - Etch Rev E) UNIBUS Microprocessor Programmer Timer Selection Switch E82

7. Install the M8206 (Etch Rev E) in the appropriate location in the DD11-DK nine-slot backplane (Figure 2-14).

**NOTE**

Ensure that the nonprocessor request (NPR) grant continuity wire between pins CA1 and CB1 of the backplane is removed from the location in which the M8206 is being installed.

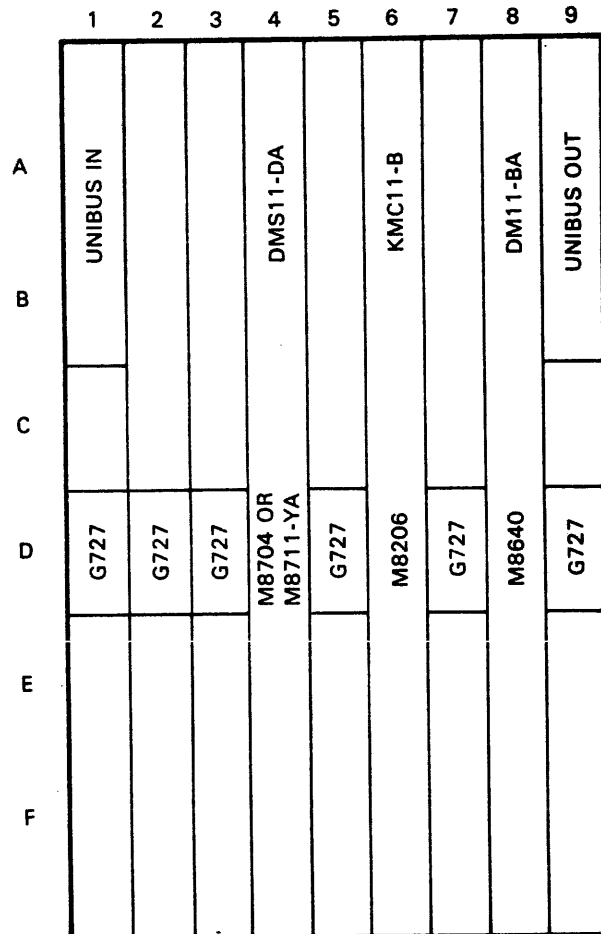

MK-3332

Figure 2-14 DD11-DK Nine-Slot Backplane with KMC11-B Board Locations (Viewed from the Backplane Pin-Side)

## CHAPTER 3 PROGRAMMING

### 3.1 INTRODUCTION

The KMC11-B microprocessor uses a 16-bit instruction code. The 16-bit instruction code for the KMC11-B microprocessor is divided into the following major instruction sets:

- Move class instruction set, and
- Branch class instruction set.

The basic functions of both move and branch class instructions include the ability to perform a designated arithmetic or logical operation on the source operands.

### 3.2 MOVE INSTRUCTIONS

The move instruction is made up of one 16-bit word consisting of two eight-bit bytes; the lower-order byte and the higher-order byte. (Refer to Figure 3-1.)

It is not the purpose or the intent of this section to be used for programming. This section is to be used only as a guide to the basic word formats of the move instruction set. For programming instructions, refer to the *KMC11-B Programmer's Manual* (YM-P093C-00).

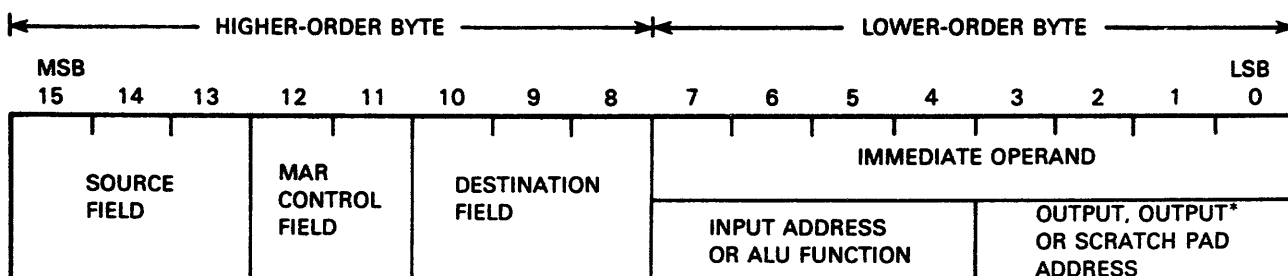

MK-4519

Figure 3-1 Move Instruction Word Format

#### Lower-Order Byte (Bits 0 to 7)

- Bits 0 to 3 (OUTPUT, OUTPUT\*, or SCRATCH PAD ADDRESS)
- Bits 4 to 7 (INPUT ADDRESS or ALU FUNCTION)

#### Higher-Order Byte (Bits 8 to 15)

- Bits 8 to 10 (DESTINATION FIELD)
- Bits 11 to 12 (MAR CONTROL FIELD)
- Bits 13 to 15 (SOURCE FIELD)

Refer to Figure 3-2 for a summary of the move instructions.

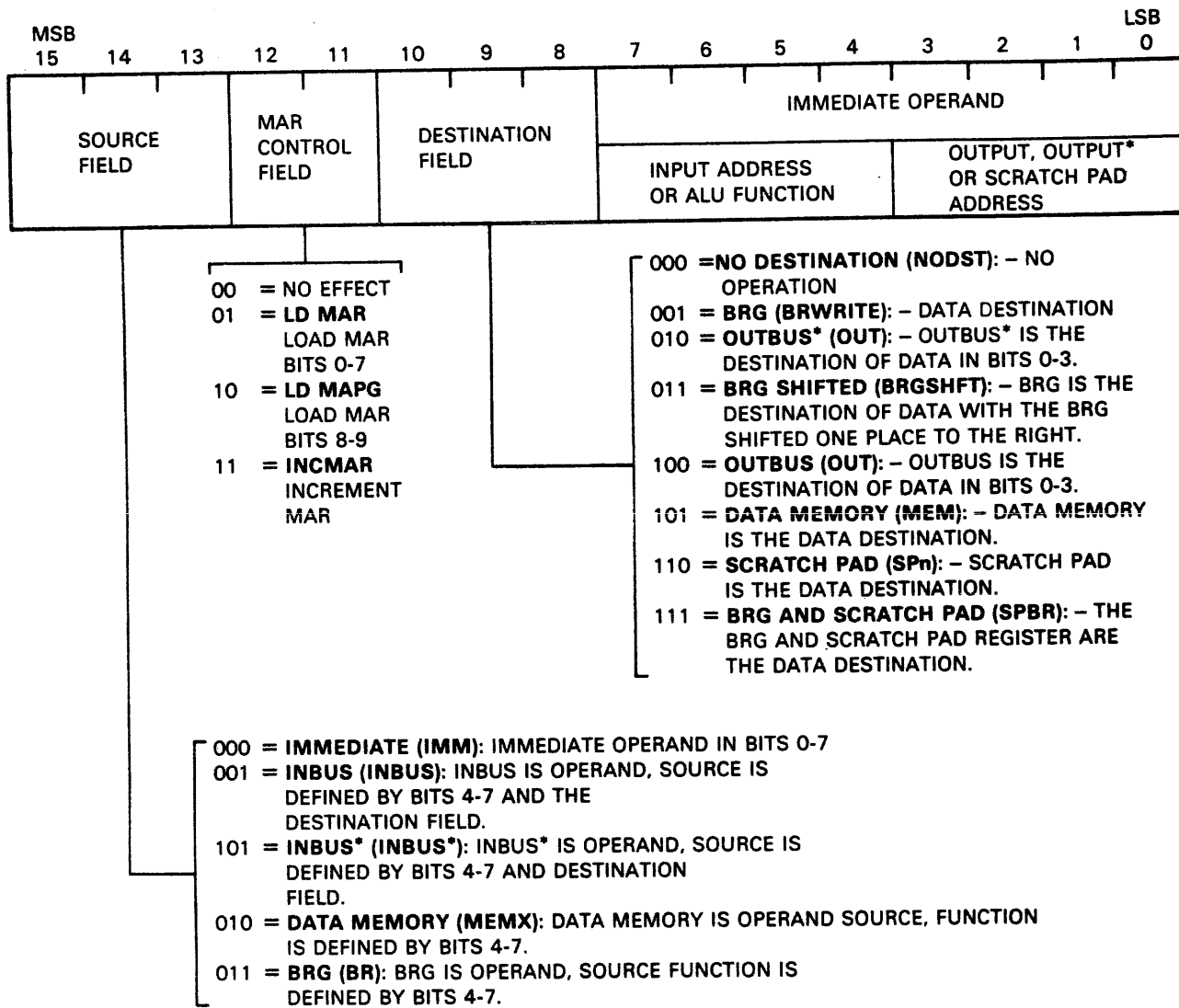

MK-4520

Figure 3-2 Move Instruction Set Summary

The move instruction set is broken into the following microinstructions:

- Move Immediate [IMM]
- Move From the IN BUS [IBUS]
- Move Instruction IN BUS\* [IBUS\*]
- Move Memory [MEM]
- Move Branch Register [BRG]

### 3.3 BRANCH INSTRUCTIONS

The branch instruction is made up of one 16-bit word consisting of two eight-bit bytes; the lower-order byte and the higher-order byte. (Refer to Figure 3-3.)

It is not the purpose or the intent of this section to be used for programming. This section is to be used only as a guide to the basic word formats of the branch instruction set. For programming instructions, refer to the *KMC11-B Programmer's Manual* (YM-P093C-00).

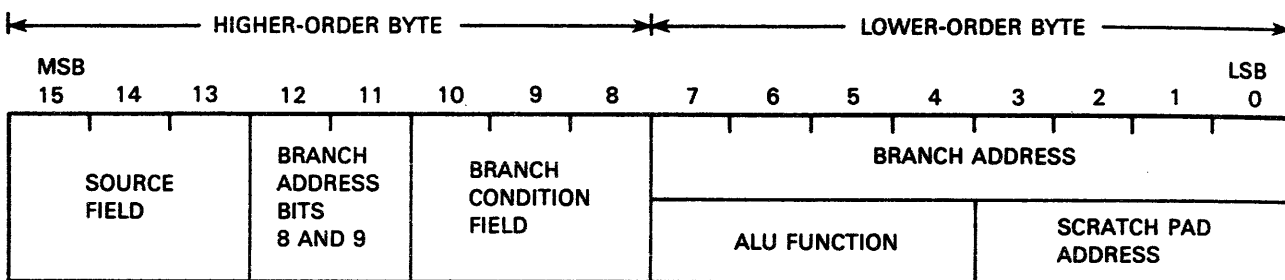

MK-4521

Figure 3-3 Branch Instruction Word Format

#### Lower-Order Byte (Bits 0 to 7)

- Bits 0 to 3 (SCRATCH PAD ADDRESS)
- Bits 4 to 7 (ALU FUNCTION)

#### Higher-Order Byte (Bits 8 to 15)

- Bits 8 to 10 (BRANCH CONDITION)
- Bits 11 to 12 (BRANCH ADDRESS BITS 8 & 9)
- Bits 13 to 15 (SOURCE FIELD)

Refer to Figure 3-4 for a summary of the branch instructions.

The branch instruction set is broken into the following microinstructions:

- Branch Immediate [IMM]
- Branch Memory [MEM]
- Branch Branch Register [BRG]

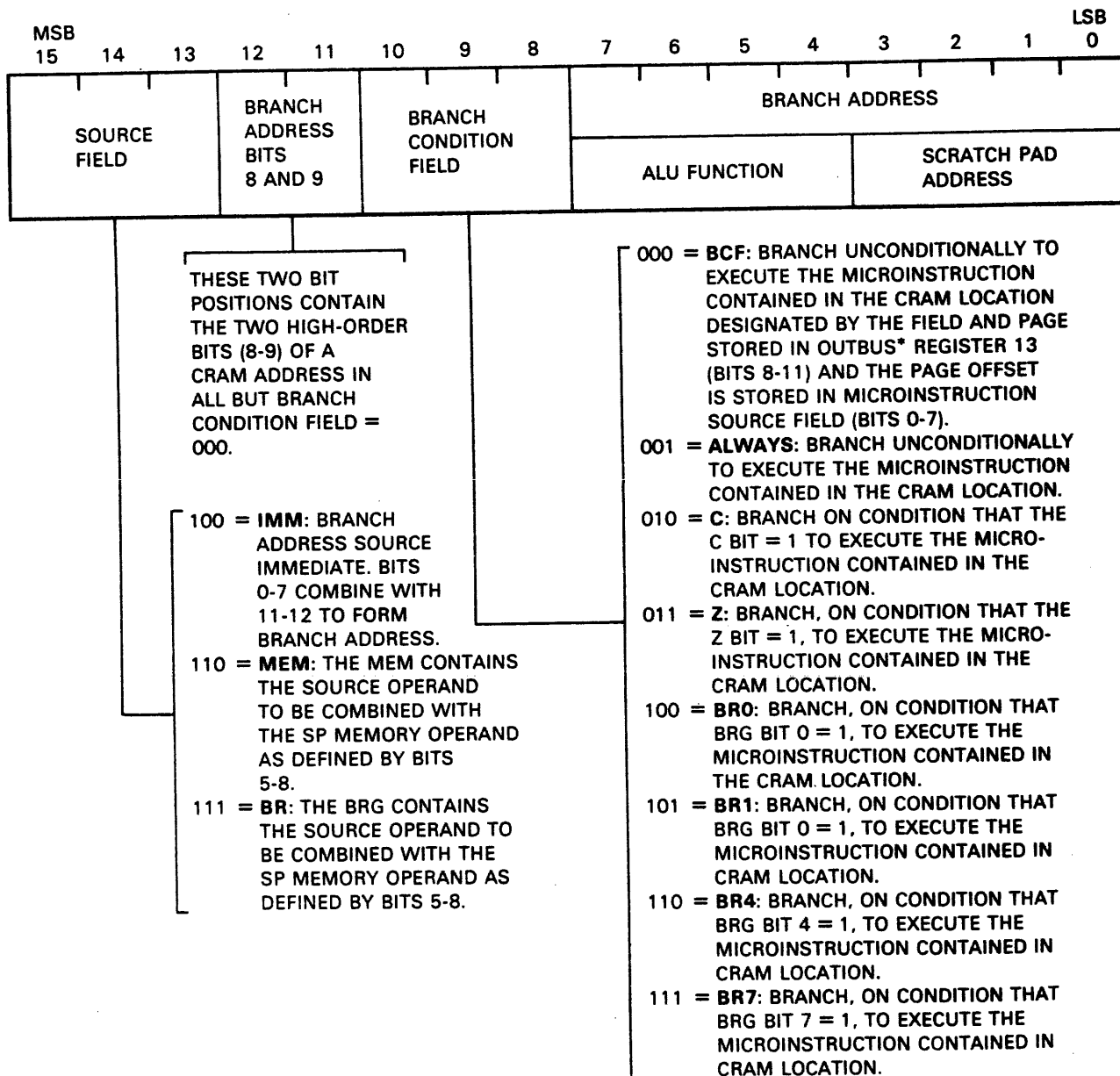

MK-4522

Figure 3-4 Branch Instruction Set Summary

## CHAPTER 4 MAINTENANCE

### 4.1 INTRODUCTION

Although the maintenance on the KMC11-B UNIBUS microprocessor is minimal, this chapter contains the information that will aid the user in performing the minimal maintenance on the KMC11-B microprocessor.

### 4.2 MAINTENANCE PHILOSOPHY

The KMC11-B (M8206) UNIBUS microprocessor is a complex, high-speed microprocessor that is densely packaged on a hex-height module. Because of this, troubleshooting is difficult and can be time consuming. *Field repair of the M8206 module is not to be attempted.* (Refer to Figure 4-1 for the diagnostic flowchart.)

### 4.3 SPECIAL TOOLS AND EQUIPMENT

There are no special tools or special equipment needed to perform field maintenance on the KMC11-B UNIBUS microprocessor.

### 4.4 DIAGNOSTIC SOFTWARE

Two diagnostics are provided for verifying the operational status of the KMC11-B UNIBUS microprocessor when it is connected to a PDP-11 system. Two diagnostics are provided for verifying the operational status of the KMC11-B when it is connected to the VAX-11 family of microprocessors.

Before running diagnostics on the KMC11-B microprocessor, remember the following:

- There is no need to disconnect the line units from the KMC11-B microprocessor unless they are thought to be faulty,
- Loop-back test connectors are not needed to perform diagnostic testing, if the testing is performed in the internal mode, and
- A faulty line unit can cause the KMC-11 microprocessor diagnostic to fail.

### 4.5 PDP-11 FAMILY DIAGNOSTICS

The PDP-11 family diagnostics (CZKMA and CZKMB) run under the control of the diagnostic supervisor. For detailed information on the use of these tests, consult the individual diagnostic listings.

#### NOTE

**There are no special options or special conditions that must be preset before the KMC11-B PDP-11 family diagnostics are run.**

### 4.6 VAX-11 FAMILY DIAGNOSTICS

The VAX-11 family diagnostics (ZZ-EVDHA and ZZ-EVDHB) run under the control of the diagnostic supervisor. For detailed information on the use of these tests, consult the individual diagnostic listings.

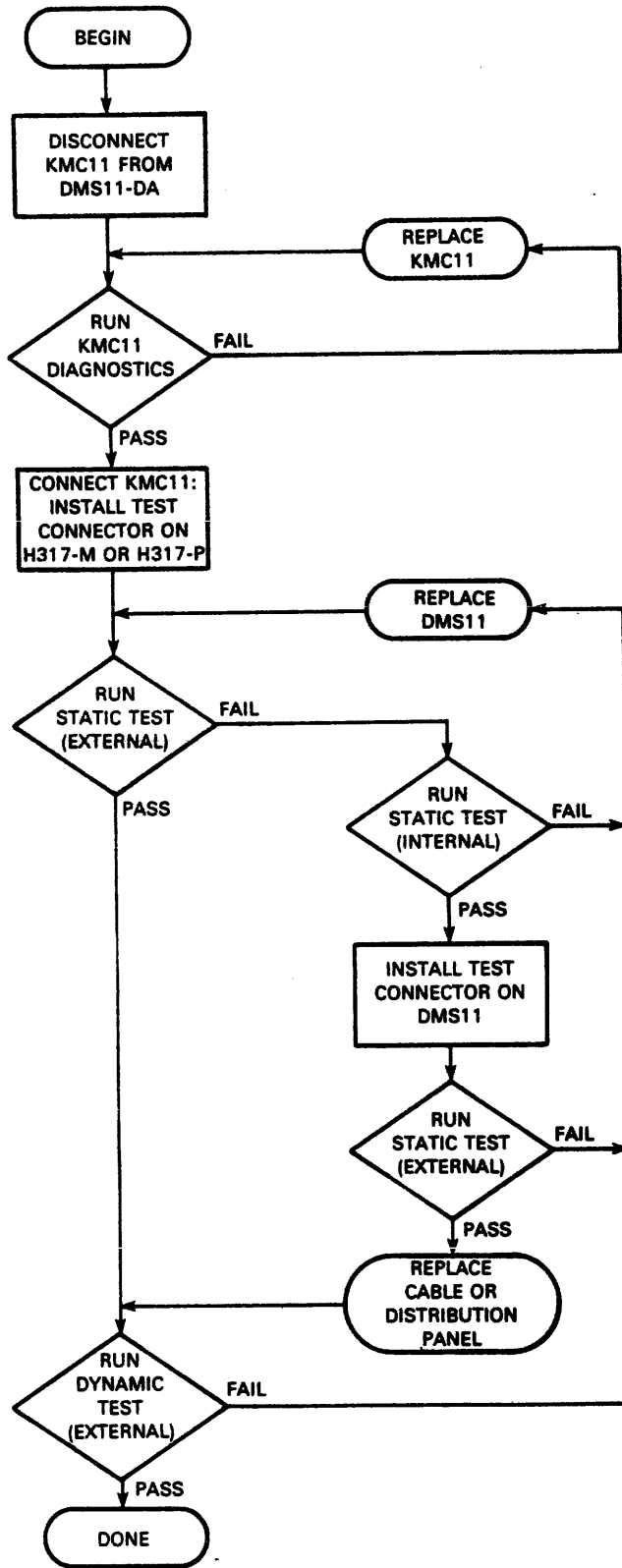

MK-3320

Figure 4-1 KMC11-B Diagnostic Flowchart

#### **4.7 PREVENTIVE MAINTENANCE**

The only preventive maintenance that must be performed on the KMC11-B microprocessor is the running of the diagnostics and the performance of tests to determine that all voltage levels are correct.

#### **NOTE**

**The +5 volt level can be checked on backplane pins AA2, BA2, CA2, DA2, EA2, and FA2.**

#### **4.8 DIAGNOSTIC LISTINGS**

Since diagnostics have a reputation for changing, it is always best to get the latest diagnostic listing so that the latest proven software can be used. The diagnostic listing numbers for both PDP-11 and VAX-11 systems are as follows:

##### **PDP-11 System Diagnostics**

CZKMB (YM-Z093D-A)  
CZKMC (YM-Z093D-B)

##### **Diagnostic Listing Number**

AC-S875A-MC  
AC-S878A-MC

##### **VAX-11 System Diagnostics**

ZZ-EVDHA  
ZZ-EVDHB

##### **Diagnostic Listing Number**

ZZ-EVDHA  
ZZ-EVDHB





## APPENDIX A KMC11-B OPTION DESIGNATIONS

### A.1 INTRODUCTION

This appendix lists the option variations available for the KMC11-B General Purpose Microprocessor. The method for assigning KMC11-B option designations is also described.

The communications option designations enable DIGITAL customers to obtain communication options that are tailored to their particular needs. FCC regulations require that all system cabinets manufactured after October 1, 1983 and intended for use in the United States, be designed to limit electromagnetic interference (EMI). Since both shielded and unshielded cabinets currently exist in the field, DIGITAL provides separate communication options for each cabinet type.

### A.2 OPTION DESIGNATION CONVERSION

Most older KMC11-B configurations are discontinued or changed to MAINTENANCE ONLY status. Therefore, the new option designations described in this appendix must be specified to obtain the necessary equipment. Table A-1 can be used to determine which communication option designations are necessary when designing or expanding upon a computer system.

Communication options may be obtained by customers either at the time of system purchase (a factory-installed system option) or as an upgrade to an existing system (a field upgrade).

**Table A-1 Option Compatibility Cross Reference**

OLD OPTION	EQUIVALENT NEW OPTION		
	Field Upgrade	System Option	
	Base Option	Cabinet Kit	
KMC11-A	KMC11-M	*	KMC11-MP <sup>1</sup>

**NOTE**

1. The last character of the system option designation is always "P". This specifies that the option is to be factory installed.

---

\*There are no cabinet kits for the KMC11-M

### A.2.1 Factory-Installed System Options

A factory-installed system option is identified by a single option designation. When this designation is specified (see Table A-1), the appropriate module(s) is installed in the particular system being constructed.

### A.2.2 Field Upgrade Options

A field upgrade option is made up of a base option designation. Refer to Table A-1 for option compatibility cross reference.

**A.2.2.1 Base Options** – The base option designation specifies which component parts make up the base option. The component parts specified are:

- The module(s),
- The turnaround test connector(s), and
- The option documentation.

## A.3 OPTION CONFIGURATION SUMMARY

This section describes the method used to assign communication option designations.

Communication options may be obtained either at the time of system purchase (a factory-installed system option) or as an upgrade to an existing system (a field upgrade).

The basic designations identify:

- System options (factory installed).
- Base options (field upgrades).

System options are installed at the factory and are configured for the particular cabinet in which the option is being installed.

Base options are obtained as upgrades to existing systems.

### NOTE

**A field upgrade option alone does not make an unshielded cabinet FCC compliant. Shielded cabinets are specially constructed to limit EMI.**

### A.3.1 System Option Designations

System option designations provide the following information:

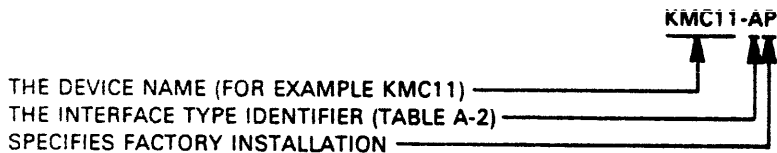

### A.3.2 Base Option Designations

Base option designations provide the following information:

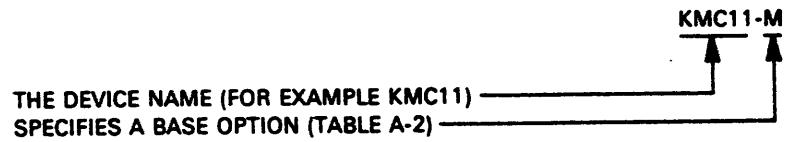

TK-10715

**Table A-2 Electrical and Mechanical Interface Type**

<b>Identifier</b>	<b>Interface Type</b>
M	Base option - Module(s), documentation, and test connectors

**EDUCATIONAL SERVICES  
DEVELOPMENT AND PUBLISHING  
UPDATE NOTICE**

***KMC11-B GENERAL PURPOSE MICROPROCESSOR USER GUIDE  
EK-KMC1B-UG-CN1  
OCTOBER 1983***

**Copyright © 1983 by Digital Equipment Corporation**

**INSTRUCTIONS**

**This Update Package should serve as an accompanying document to your original manual.**

Your comments and suggestions will help us in our continuous effort to improve the quality and usefulness of our publications.

What is your general reaction to this manual? In your judgement is it complete, accurate, well organized, well written, etc? Is it easy to use? \_\_\_\_\_  
\_\_\_\_\_  
\_\_\_\_\_

What features are most useful? \_\_\_\_\_  
\_\_\_\_\_  
\_\_\_\_\_

What faults or errors have you found in the manual? \_\_\_\_\_  
\_\_\_\_\_  
\_\_\_\_\_

Does this manual satisfy the need you think it was intended to satisfy? \_\_\_\_\_

Does it satisfy *your* needs? \_\_\_\_\_ Why? \_\_\_\_\_  
\_\_\_\_\_  
\_\_\_\_\_

Please send me the current copy of the *Technical Documentation Catalog*, which contains information on the remainder of DIGITAL's technical documentation.

Name \_\_\_\_\_ Street \_\_\_\_\_  
Title \_\_\_\_\_ City \_\_\_\_\_  
Company \_\_\_\_\_ State/Country \_\_\_\_\_  
Department \_\_\_\_\_ Zip \_\_\_\_\_

Additional copies of this document are available from:

Digital Equipment Corporation  
444 Whitney Street  
Northboro, MA 01532

Attention: Printing and Circulation Services (NR2/M15)  
Customer Services Section

Order No.   EK-KMC1B-UG-001



