

SERIES 700 READERS/SPOOLERS

INSTRUCTION MANUAL

DOCUMENT NO. 1200-113

DECITEK

SERIES 700 READERS/SPOOLERS

INSTRUCTION MANUAL

DOCUMENT NO. 1200-113

FOR CUSTOMER SERVICE CONTACT:

**DECITEK CORPORATION
25 South Street
Hopkinton, MA 01748
Telex: 951811**

PROPRIETARY NOTICE

The information and design of the equipment described herein are the sole property of Decitek Corporation. This document is proprietary to Decitek and the information contained herein is for use by the Corporation, its authorized representatives, and by users of this equipment. This information is not to be reproduced in whole or in part without written permission of an authorized official of Decitek Corporation. The foregoing does not apply to vendor proprietary parts.

DECITEK CORPORATION
25 South Street
Hopkinton, MA 01748
Telex: 951811

WARRANTY

Decitek warrants that all goods furnished hereunder will at the time of shipment be free from defects in material and workmanship and will conform to Decitek's applicable specifications, or if appropriate to specifications accepted by Decitek therefor. Decitek's obligation hereunder shall be limited to, at Decitek's option, either refunding the purchase price of, repairing or replacing, any products for which written notice of nonconformance hereunder is received by Decitek within Decitek's Standard Warranty period for the specific product; provided such nonconforming products are with Decitek's prior authorization, returned F.O.B. Decitek's plant at Buyer's expense. This warranty shall not apply to any products in other than their original condition, or to any products which Decitek determines have, by Buyer or otherwise been subjected to operating and/or environmental conditions in excess of the maximum values therefor in the applicable specifications or otherwise have been the subject of misuse, neglect, improper installation, repair, alteration or damage.

The foregoing warranties shall extend to Buyer, its successors, assigns, customers and ultimate users of his products. THESE WARRANTIES ARE EXPRESSLY IN LIEU OF ALL OTHER WARRANTIES WHETHER EXPRESSED, IMPLIED OR STATUTORY, INCLUDING IMPLIED WARRANTIES OF MERCHANTABILITY OR FITNESS. IN NO EVENT WILL DECITEK BE LIABLE FOR ANY SPECIAL, INCIDENTAL OR CONSEQUENTIAL DAMAGES.

NOTE: Warranty periods for specific products are as follows:

Series 700 Readers and Reader/Spoolers: One (1) full year from date of shipment.

These readers have been tested and qualified for FCC approval.

TABLE OF CONTENTS

PARA.		PAGE
	SECTION I – GENERAL DESCRIPTION	
1.1	Scope	1-1
1.2	Equipment Description	1-1
1.3	Features	1-3
1.4	Specifications	1-4
1.4.1	Physical	1-4
1.4.2	Environment	1-4
1.4.3	Power	1-5
1.4.4	Functional	1-5
	SECTION II – INSTALLATION	
2.1	Unpacking	2-1
2.2	Inspection	2-1
2.3	Equipment Mounting	2-1
2.4	Power	2-1
2.5	Pre-Use Switch Selection	2-1
	SECTION III – OPERATOR INSTRUCTIONS	
3.1	Operator Switches and Display	3-1
3.2	Operating Modes	3-4
3.2.1	Self Exercise Mode	3-4, 3-5
3.2.2	Self Test Modes	3-5
3.2.3	Parallel Mode	3-6
3.2.4	Serial Mode	3-7
3.2.4.1	Serial Operation	3-7
3.2.4.2	Baud Rates	3-8
3.2.4.3	Serial I/O Interfacing	3-9
3.2.4.4	Serial Options	3-9
3.2.5	Control Codes, Serial Operation	3-10
3.3	Jumper Configurations	3-10
3.3.1	Description for jumper use	3-10
	SECTION IV – THEORY OF OPERATION	
4.1	Parallel Mode	4-1
4.2	Level Wind/Rewind	4-1
4.3	Pulse Wind/Rewind	4-1
4.4	Read/Wind Direction Change	4-1

PARA.		PAGE
	SECTION IV – THEORY OF OPERATION (cont'd)	
4.5	Stop On Character	4-4
4.6	Loop Mode	4-4
4.7	Data Handling	4-4
4.8	Interrupt Logic	4-5
4.8.1	Sprocket Interrupt	4-5
4.8.2	Read Right Interrupt	4-7
4.8.3	Wind Right Interrupt	4-7
4.8.4	Read/Wind Interrupt	4-7
4.9	Special Features	4-8
4.9.1	Parity Checking	4-8
4.9.2	Bad Tape Detection	4-8
4.10	Serial Operation	4-9
4.10.1	Protocol Level I	4-9
4.10.2	Protocol Level II	4-9
	SECTION V – INTERFACE	
5.1	Parallel I/O	5-1
5.1.1	Interface Cable	5-1
5.1.2	Parallel Input Signals	5-2
5.1.3	Parallel Output Signals	5-5
5.2	Serial I/O	5-6
5.2.1	Interface Cable	5-6
5.2.2	Serial Input Signals	5-8
5.2.3	Serial Output Signals	5-9
	SECTION VI – MAINTENANCE	
6.1	Preventive Maintenance	6-1
6.2	Routine Maintenance	6-1
6.3	Recommended Spare Parts	6-1

LIST OF ILLUSTRATIONS

FIGURE NO.	TITLE	PAGE
1-1	Series 700 Readers & Reader/Spoolers	1-2
2-1	AC Connector	2-2
3-1	Operator Switches & Display	3-1
3-2	Switch, Connector Location, 762A9, B9, C9	3-2
3-3	Switch, Connection Location, 762D9	3-3
3-4	Jumper Locations	3-11
4-1	Spool Mode Timing (Level Operation)	4-2
4-2	Pulse Drive Timing	4-3
4-3	Interrupt Handling Flow Diagram	4-6
5-1	20 ma Loop Interface	5-10
6-1	Main PC Board	6-2
6-2	Serial PC Board	6-3
6-3	Power Supply	6-4
6-4	Servo Board	6-5
6-5	Reader Module, 762A9, B9	6-6
6-6	Reader Module, 762C9, D9	6-7

LIST OF TABLES

TABLE NO.	DESCRIPTION	PAGE
4-1	Interrupt Priorities	4-5
5-1	Logic Connector J1	5-3
5-2	Logic Connector J5	5-4
5-3	Logic Connector J2	5-7

SECTION I

GENERAL DESCRIPTION

1.1 SCOPE

This manual contains operation and maintenance information for all Decitek Series 700 micro-processor based reader and reader/spoolers.

762A9	reader/spooler	rack mount	8 ¾" x 19"
762B9	reader/spooler	rack mount	5 ¼" x 19"
762C9	reader ass'y	rack mount	5 ¼" x 19"
762D9	reader ass'y	table top	portable

1.2 EQUIPMENT DESCRIPTION

The Microprocessor Based Punched Tape Reader (Fig. 1-1) converts hole patterns in punched paper tape to electrical signals. These data signals are stored in a data buffer until requested by a host control. As data is depleted from the buffer, the tape is advanced for buffer refresh.

Operator controls and display are mounted on the reader module front panel. These switches are for power, read right, read left, loop/spool and search/home. The display has several important features. Both switches and display are explained in a later paragraph.

The read head contains dual sprocket tape drive and uses a fibre optic array for light transmission to phototransistors for detection. In the reader/spooler version, the stepper motor is used only for tape parking. Tape transport to the right is accomplished by the right spooler motor; left by the left spooler motor. This feature provides for lower power consumption.

Control, data conversion, power and logic circuits are contained on modular circuit boards. The read head is easily removable as a module.

- (a) The main pc board contains the drive logic, cpu, control logic circuitry and parallel I/O.
- (b) The servo board controls the spooler mode.
- (c) The power supply module provides the DC power required by the unit.
- (d) The serial I/O board is optional and contains switches for serial operation.
- (e) The reader module contains stepper motor, read electronics, sprocket drive, fibre optic array, operator switches and LED array.

SERIES 700 READERS & READER/SPOOLERS

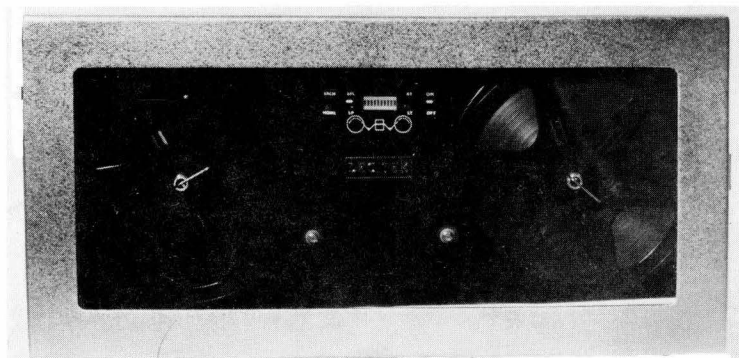

762A9

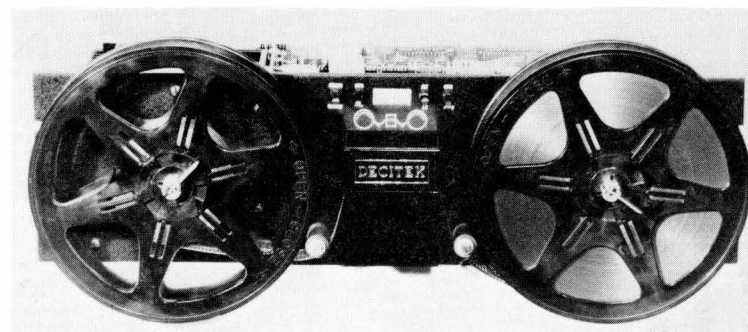

762B9

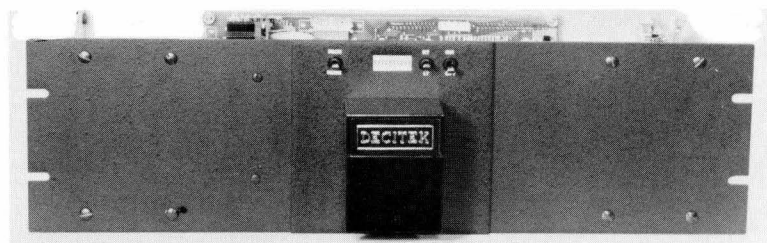

762C9



762D9

1.3 FEATURES

The Series 700 Readers and Reader/Spoolers have the following unique features:

- Parallel data transfer - 200, 300 or 600 CPS (selectable read speeds)
- Serial data transfer - RS232/TTY - 50 to 19.2K baud
- Microprocessor control
- Code conversion
 - BAUDOT to ASCII
 - EBCDIC to ASCII
 - EIA to ASCII
- Self test
- Ecco/Remex compatibility
- Parity check
- Damaged tape detect
- Elongated sprocket hole compensation
- Auto return to load point (bi-directional)
- Single step right or left
- Modular construction
- Custom firmware features available
- D N C CHANNEL available as an option.

NOTE: Reader assemblies 762C9 and 762D9 will operate at read speeds 200 CPS only.
300 CPS is an option.

1.4 SPECIFICATIONS

1.4.1 PHYSICAL DIMENSIONS

762A9 Reader/Spooler (rack mount)

Height	8.72 in
Width	19.00 in
Depth	5.85 in
Weight	19.00 lbs

762B9 Reader/Spooler (rack mount)

Height	5.22 in
Width	19.00 in
Depth	6.02 in
Weight	18.00 lbs

762C9 Reader Assembly (rack mount)

Height	8.72 in
Width	19.00 in
Depth	6.02 in
Weight	13.00 lbs

762D9 Reader Assembly (table top)

Height	6.66 in
Width	10.72 in
Depth	6.34 in
Weight	13.00 lbs

1.4.2 ENVIRONMENTAL

Operating Temperature	=	0°C to 70°C (32F to 158F)
Storage Temperature	=	-25°C to 100°C (-13F to 212F)
Operating Relative Humidity	=	10% to 95%
Storage Relative Humidity	=	0% to 100%

1.4.3 POWER REQUIREMENTS

115 VAC \pm 10%, @ 2 A (50/60 Hz)

230 VAC \pm 10%, @ 1 A (50/60 Hz)

+5 VDC @ 1.2 A

+24 VDC @ 2.0 A

+14 VDC @ 2.0 A

Power Dissipation: 80 Watts (maximum)

50 Watts (typical)

1.4.4 FUNCTIONAL

Read Speed - 762A9, 762B9

0 to 600 CPS, step mode

200, 300, 600 CPS, slew mode (selectable) spoolers only
(stop-on-character)

Read Speed - 762C9, 762D9

0 to 200 CPS, step mode

200 CPS, slew mode (300 CPS optional)
(stop-on-character)

Wind Speed

0 to 600 CPS, step mode

600 CPS, slew mode
(stop-on-character)

Tape

Paper, oiled paper, mylar 5, 6 and 8 level. Transmissivity up to 40%. Advanced and center feed holes without adjustment.

SECTION II

INSTALLATION

2.1 UNPACKING

Each reader and reader/spooler assembly is individually packaged to insure adequate protection during shipping and handling.

Remove reader from shipping container. Remove packaging material from reader. Check material received against packing list. Inspect all items for damage.

2.2 INSPECTION

Carefully inspect the reader for any shipping damage or loose hardware. Check for foreign material inside chassis and read head. DO NOT attempt to operate reader if damaged or with foreign material in chasses.

2.3 MOUNTING

Mounting holes are provided for installation in a standard 19" RETMA equipment rack.

2.4 POWER

WARNING

Power line must have a third wire ground for safe and proper operation of this equipment.

CAUTION

Electrical power for the reader is selected from two (2) line input potentials: 115 and 230 VAC. The selection will be made at the factory in accordance with customer specifications. If a change is to be made see Figure 2-1 for proper setting and fuse selection.

2.5 PRE-USE SWITCH SELECTION

Before operating reader, be sure that all switches have been set for mode of operation desired. See Section III - Operator Instructions.

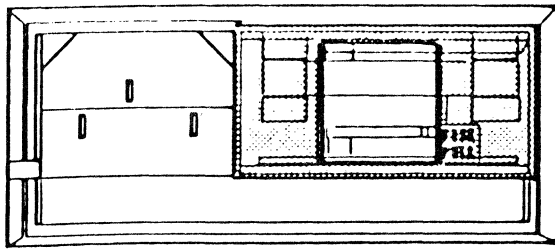

AC FUSE HOLDER

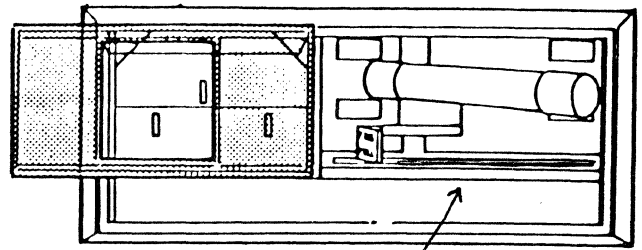

PC CARD

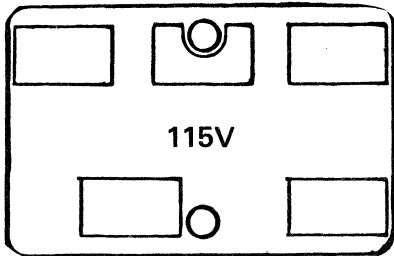

115V

PC card position for line voltage
105 - 130 Volts. Use 2 A slo blo fuse.

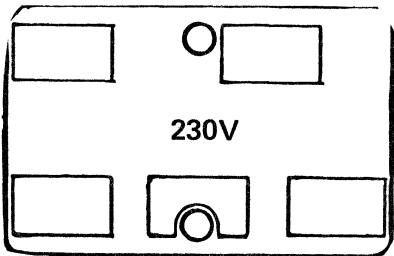

230V

PC card position for line voltage
210 - 260 Volts. Use 1 A slo blo fuse.

PC card shown top view. Arrow is direction for insert.

SECTION III OPERATOR INSTRUCTIONS

3.1 OPERATOR SWITCHES & DISPLAY

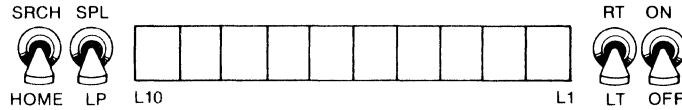

Fig. 3-1

- ON/OFF** Applies power to unit - a built in delay will allow any tape slack to be wound before ready lamp (L10) will illuminate. Tape will not move until manually moved by the RT/LT switch or by a drive command from the host control.
- RT/LT** Manual drive right, drive left switch. Reader will drive in direction selected as long as switch is held. Momentary depression will cause single character step.
- *SPL/LP** With switch in the SPL position, the reader is ready for operation in the spooler mode. The LP position provides for reader operation with a loop or unspooled sections of tape.
*Not installed on 762C9 or 762D9.
- SEARCH/HOME** This switch is a momentary action switch for both functions. The search position is to allow the operator to return the tape to the exact position of the character at the I/O. This operation is functional only when the reader has stopped. Search mode automatically places the reader in the loop mode during character search. The reader will return to spool mode when the search is complete.
THE HOME function allows the operator to return the tape to the exact read start position. This function is operational in either direction and may be used for autorewind. To establish a home position, lift cover, and close. The character under the read head at this time is the home character.
- DISPLAY** The LED display is a ten lamp display which provides the operator with both fault information and data monitoring. During normal operation, lamp 1 (L1) through lamp 8 (L8) displays the data present at the I/O. Lamp 10 indicates that the reader is ready for operation. This lamp will illuminate after a short delay when the reader is turned on. Should this lamp blink after power is applied a fault is indicated (go to self test) See Section 3.2.

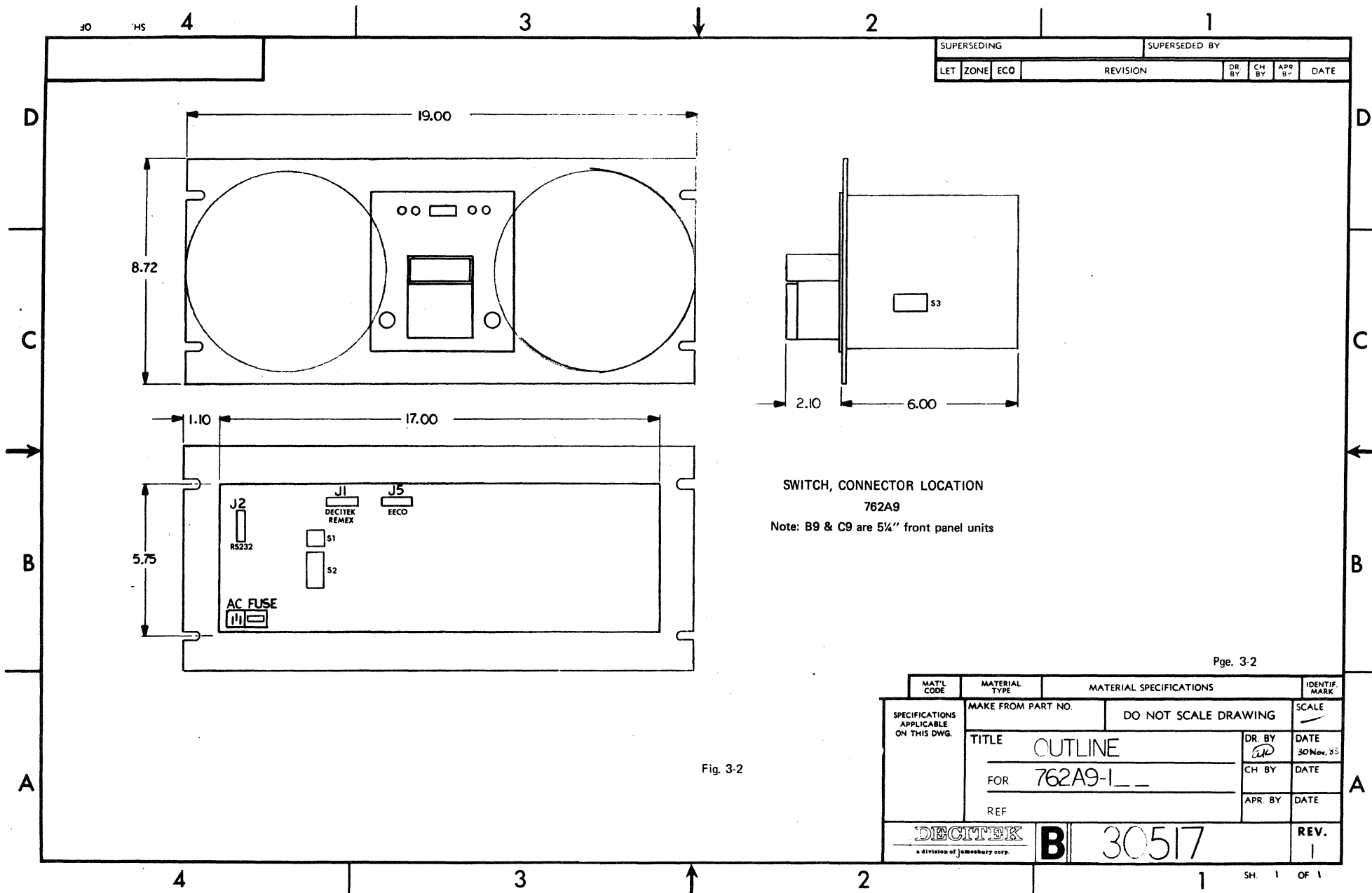

Fig. 3-2

SUPERSEDING			SUPERSEDED BY					
LET	ZONE	ECO	REVISION		DR. BY	CH. BY	APP. BY	DATE

SWITCH, CONNECTOR LOCATION
762A9

Note: B9 & C9 are 5/4" front panel units

Pge. 3-2

MAT'L CODE	MATERIAL TYPE	MATERIAL SPECIFICATIONS		IDENTIF. MARK
SPECIFICATIONS APPLICABLE ON THIS DWG.		MAKE FROM PART NO.	DO NOT SCALE DRAWING	SCALE <input checked="" type="checkbox"/>
TITLE		OUTLINE		DR. BY <i>ED</i>
FOR		762A9-1__		DATE 30 Nov. 85
REF				CH. BY
				DATE
				APR. BY
				DATE
DECITEK a division of Jamebury corp.		B 30517		REV. 1

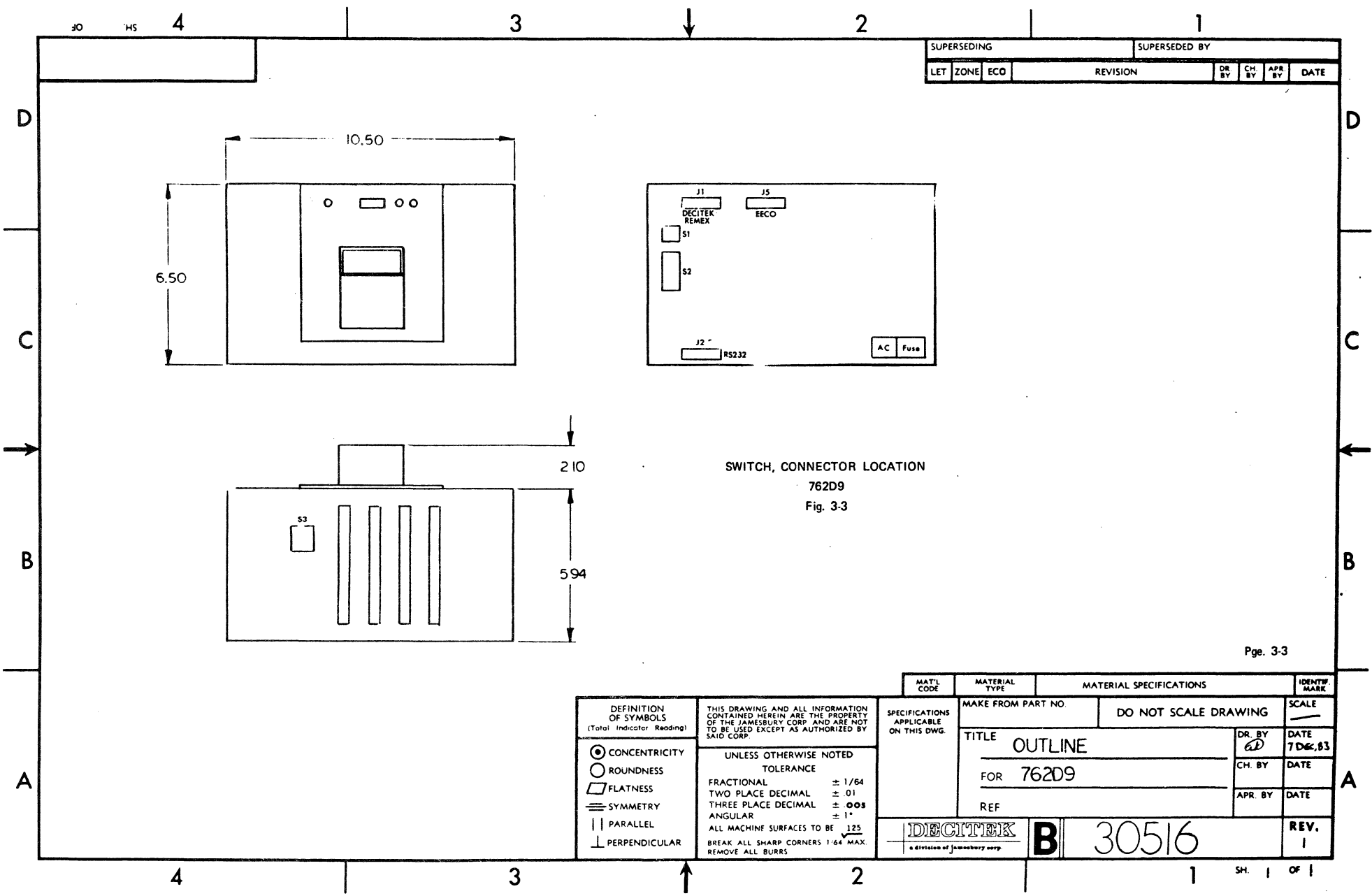

SUPERSEDING			SUPERSEDED BY				
LET	ZONE	ECO	REVISION	DR BY	CH BY	APR BY	DATE

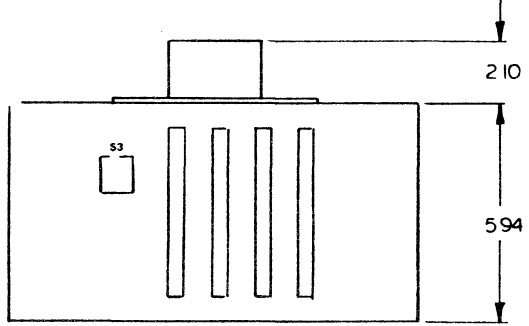
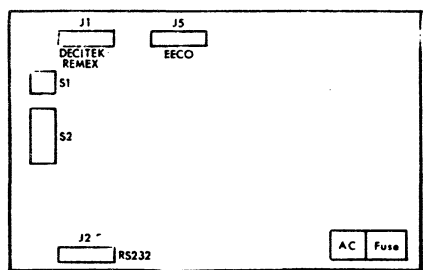

SWITCH, CONNECTOR LOCATION
762D9
Fig. 3-3

DEFINITION OF SYMBOLS (Total Indicator Reading)		THIS DRAWING AND ALL INFORMATION CONTAINED HEREIN ARE THE PROPERTY OF THE JAMESBURY CORP. AND ARE NOT TO BE USED EXCEPT AS AUTHORIZED BY SAID CORP.	SPECIFICATIONS APPLICABLE ON THIS DWG.	MAT'L CODE	MATERIAL TYPE	MATERIAL SPECIFICATIONS		IDENTIF. MARK
⊙ CONCENTRICITY	○ ROUNDNESS			MAKE FROM PART NO.		DO NOT SCALE DRAWING		SCALE
▭ FLATNESS	≡ SYMMETRY	UNLESS OTHERWISE NOTED TOLERANCE	TITLE	DR. BY	DATE	REF		
PARALLEL	⊥ PERPENDICULAR	FRACTIONAL ± 1/64	FOR 762D9	CH. BY	DATE	REF		
		TWO PLACE DECIMAL ± .01		APR. BY	DATE	REF		
		THREE PLACE DECIMAL ± .005				REF		
		ANGULAR ± 1°				REF		
		ALL MACHINE SURFACES TO BE ± .125	DECITEK		B 30516		REV. 1	
		BREAK ALL SHARP CORNERS 1/64 MAX. REMOVE ALL BURRS.	a division of Jamesbury corp.					

3.2 OPERATING MODES

In addition to the operator switches located on the front panel, there are three (3) sets of dip switches located, two (2) on the rear panel S1 and S2, and one (1) on the right side of the reader (facing reader) S3. For location of these switches, see Figure 3-2.

S1 is a four (4) section dip switch which provides operation in the following modes:

- Self Exercise
- Self Test — Serial or Parallel
- Parallel Operation
- Serial Operation

S2 is a twelve (12) section dip switch used primarily for the serial mode of operation and includes the following selections:

- Serial Word Format
- Serial Protocol
- Baud Rate Selection

S2 also includes provisions for:

- Data Rate — 200, 300 or 600 (parallel only)
- Direction Change Delay — .5 sec., 1.0 sec., 1.5 sec.
- Code Conversion (in parallel mode)

S3, used for serial only, is an eight (8) section dip switch which provides for communication interfacing to the host control and offers the following selections:

- | | |
|----------------------|----------------------|
| Data Carrier Detect | Internal or External |
| Clear to Send | Internal or External |
| Data Set Ready | Internal or External |
| RS232 or TTY | |
| Current Loop Current | Active or Passive |

3.2.1

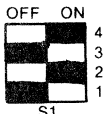
		<u>S1-1</u>	<u>S1-2</u>	<u>S1-3</u>	<u>S1-4</u>
SELF EXERCISE MODE		OFF	ON	OFF	ON

The self exercise mode of operation provides the operator with a system for testing the reader functions without operator assistance and without a host system.

To operate in this mode requires that a hex 05 be punched at the beginning of the tape and a hex 85 at the end. THIS IS A BUFFERED READER AND REQUIRES THAT YOUR LEADER AND TRAILER BE AT LEAST 21 INCHES LONG.

3.2.1 (cont'd)

Load tape and apply power. The reader will read right until it detects a reverse code (Hex 85). It will then reverse direction until it sees another reverse code (Hex 05). This operation will continue until the reader is turned off.

3.2.2

	<u>S1-1</u>	<u>S1-2</u>	<u>S1-3</u>	<u>S1-4</u>
<u>Self Test Modes</u>	OFF	ON	ON	ON
	OFF	OFF	ON	ON

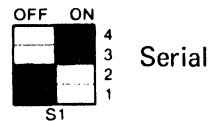
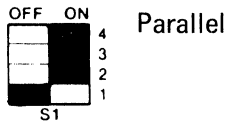

The self test mode provides testing of the several reader modules before use. The LED (Figure 3-2) display offers a visual presentation of GO or NO GO. TAPE MUST BE REMOVED FROM THE READ HEAD BEFORE TEST. When power is applied while either of the test modes are selected and the following lamps illuminate steady, the reader is considered operational.

- Lamp 1 — Extreme right on display indicates sprocket OK.
- Lamp 2 — Indicates data channels OK.
- Lamp 3 — Indicates memory and parallel I/O OK.
- Lamp 4 — (serial only) Indicates serial I/O OK.
- Lamp 8 — Indicates that you are in serial self test mode.
- Lamp 10 — Ready lamp

If a fault is detected, the ready lamp will blink and one or more of the four fault indicators will blink.

If Lamp 10 and Lamp 1 or 2 blink, replace reader module.

If Lamp 10 and 3 blink, replace main PC board.

If Lamp 10 and 4 blink, replace serial PC board.

The servo module is not being tested in either of these modes. To test for servo operation, select the parallel mode of operation. Remove spools and apply power. There will be a noticeable movement of both spindles traveling in opposite directions. With the RT/LT switch, select RT — Notice the spindle. It should increase in speed and stop. This indicates that the right servo is operational. Lift the read head cover to reset. Close cover and repeat procedure with LT. If no increase in speed is noticed, repeat procedure to be sure. Check cables from servo motors to servo card. If cables are fastened, replace servo card.

3.2.3

PARALLEL MODE

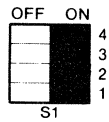

<u>S1-1</u>	<u>S1-2</u>	<u>S1-3</u>	<u>S1-4</u>
ON	ON	ON	ON

For parallel operation, S1 must be set as above.

Data rate and data polarity are selected by S2 switch settings.

<u>Data Rate</u>	<u>S2-3</u>	<u>S2-4</u>
200 CPS	ON	ON
300 CPS	ON	OFF
600 CPS	OFF	ON

<u>Data Polarity</u>	<u>S2-6</u>
Internally Selected	OFF - See note 1
Externally Selected	ON - See note 2

Note 1 - Polarity determined by S2-5

5 Volt True	S2-5	OFF
0 Volt True	S2-5	ON

Note 2 - Polarity determined by voltage level at J1 Pin 10. J1 pin 10 has a 4.7k pull-up resistor to Vcc.

5 Volt True	No connection to J1 pin 10
0 Volt True	Ground J1 pin 10

For other parallel operating considerations, e.g. REMEX or EECO compatibilities, see paragraph 3.3.1.

NOTE: S2-8 is used for code conversion. This switch should be left in the on position (no conversion) during parallel operation.

3.2.4

	<u>S1-1</u>	<u>S1-2</u>	<u>S1-3</u>	<u>S1-4</u>
<u>SERIAL MODE</u>	ON	OFF	ON	ON

For serial operation, S1 must be set as above. S2 and S3 (shown below) provide for additional serial communication considerations.

3.2.4.1

SERIAL OPERATION (S2)

Switch settings for serial operation regarding, start stop bits, word lengths, parity, protocol and baud rates are listed in the following table:

S2	<u>Stop Bits</u>	<u>S2-1</u>	<u>S2-2</u>
	Invalid	ON	ON
	1 Stop Bit	ON	OFF
	1.5 Stop Bits	OFF	ON
	2 Stop Bits	OFF	OFF
S2	<u>Parity</u>	<u>S2-3</u>	<u>S2-4</u>
	Disable	ON	ON
	Odd	ON	OFF
	Disable	OFF	ON
	Even	OFF	OFF
S2	<u>Protocol</u>	<u>S2-7</u>	
	Level I	OFF	
	Level II	ON	
	In Level I, tape movement (left to right by default) is controlled by CTS line. In Level II, tape movement is controlled by ASCII control codes (see 3.2.5)		
S2	<u>Code Conversion</u>	<u>S2-8</u>	
	Conversion	OFF	
	No Conversion	ON	

NOTE: Be sure that S2-8 is on for all operating modes except when using code conversion.

3.2.4.2

BAUD RATES

Baud rates are selectable from 50 to 19.2K baud. Rates are selected using S2 as follows.

(See Figure 3-1)

<u>S2</u>	<u>BAUD RATE SELECT</u>			
	<u>S2-9</u>	<u>S2-10</u>	<u>S2-11</u>	<u>S2-12</u>
50	ON	ON	ON	ON
75	ON	ON	ON	OFF
110	ON	ON	OFF	ON
134.5	ON	ON	OFF	OFF
150	ON	OFF	ON	ON
300	ON	OFF	ON	OFF
600	ON	OFF	OFF	ON
1200	ON	OFF	OFF	OFF
1800	OFF	ON	ON	ON
2000	OFF	ON	ON	OFF
2400	OFF	ON	OFF	ON
3600	OFF	ON	OFF	OFF
4800	OFF	OFF	ON	ON
7200	OFF	OFF	ON	OFF
9600	OFF	OFF	OFF	ON
19200	OFF	OFF	OFF	OFF

3.2.4.3 SERIAL I/O INTERFACING S3

Communications configurations for interfacing to a host control are selectable at S3.
(See Figure 3-1)

S3	Data carrier Detect	S3-1
	Internal	ON (default)
	External	OFF
S3	Clear to Send	S3-2
	Internal	ON (default)
	External	OFF
S3	Data Set Ready	S3-3
	Internal	ON (default)
	External	OFF
S3	RS232/TTY	S3-4
	RS232	ON (default)
	TTY (current loop)	OFF
S3	Transmit Loop Current Supply	S3-7
	Active	ON
	Passive	OFF (default)
S3	Receive Loop Current Supply	S3-8
	Active	ON
	Passive	OFF (default)

3.2.4.4 SERIAL OPTIONS

Located on the serial PCB is a set of dip switches labeled S4. These switches are for establishing the pin out of transmit data and receive data of the RS232C signals. The settings are as follows:

<u>Switch Setting</u>	<u>Transmit Data</u>	<u>Receive Data</u>
S4-1 ON		
S4-2 ON (default	J2 Pin 2	J2 Pin 3
S4-3 OFF setting)		
S4-4 OFF		
S4-1 OFF		
S4-2 OFF	J2 Pin 3	J2 Pin 2
S4-3 ON		
S4-4 ON		

Also located on the serial PCB are three (3) sets of pins: P1, P2, P3. For standard RS232C configurations the jumpers for these sets of pins is as follows:

- P1 No Jumpers
- P2 All Pins Jumpers Installed
- P3 Pins 1, 2, 3 & 4 Jumpers Installed
- P3 Pins 5, 6, 7 & 8 No Jumpers

The serial PCB can be configured for RS 422. For this option, please consult factory.

3.2.5 CONTROL CODES FOR SERIAL OPERATION

Control commands for basic communications capability between the reader and the host control using Level II Protocol are listed below in Table 3-6.

Read Right	DC1	(control Q)	(11)Hex or (91)Hex
Read Left	BS	(control H)	(08)Hex or (88)Hex
Stop	DC3	(control S)	(13)Hex or (93)Hex
Single Step Right		(R)	(D2)Hex or (52)Hex
Single Step Left		(L)	(CC)Hex or (4C)Hex
Set Load Point		(ESC)	(1B)Hex or (9B)Hex
Return to Load Point		(control W)	(17)Hex or (97)Hex

NOTE: Control codes are programmable and may be changed as required.

3.3 JUMPER CONFIGURATION

3.3.1 To provide compatability with the several modes of operation with the REMEX and EECO readers, a series of jumpers have been installed on the main PC board.

3.3.1 DESCRIPTION FOR JUMPERS USE

E1 Mode Select/Signal Levels (Remex mode 5/6)

	<u>Jumper In</u>	<u>Jumper Out</u>	<u>Definition</u>
Data Available	Active High	Active Low	
Reader Ready	Active High	Active Low	
Drive Acknowledge	Active High	Active Low	(Eeco only) J5
Run Status	Active Low	Active High	(Eeco only) J5

E3 Reader Ready Mode Select

<u>Jumper Location</u>	<u>Mode Selected</u>	<u>Definition</u>
Pins 2 & 3	Reader ready in level mode	Output does not toggle
Pins 1 & 2	Reader ready in pulse mode	Output toggles for each data available

E2 is not selectable on PCB.5 of the number sign 60283-3 Revision.
(See PCB for imprinted number)

MAIN PC BOARD

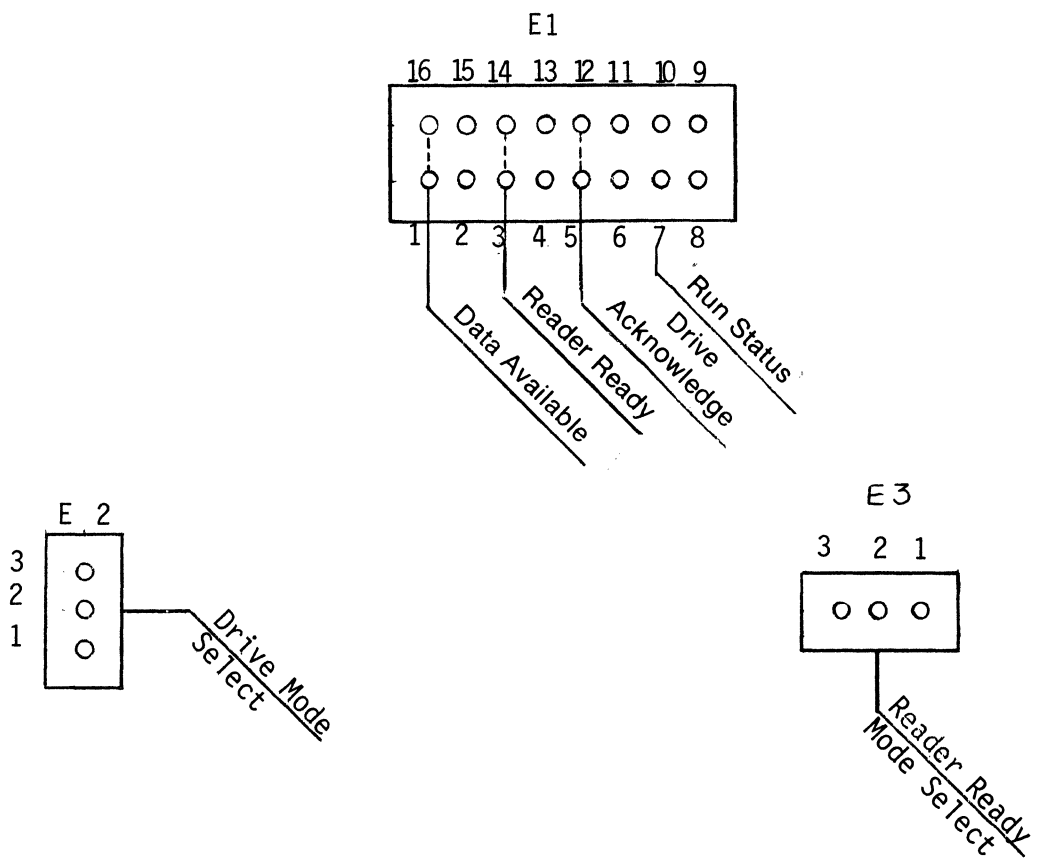
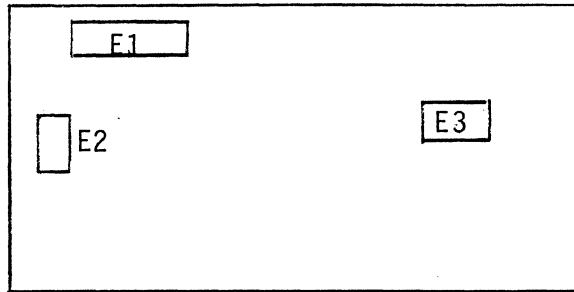

Figure 3-4
Jumper Locations

SECTION IV

THEORY OF OPERATION

4.1 PARALLEL MODE

After all switches have been set for parallel mode of operation, (Section III) the tape may be loaded, close reader cover and turn power on. There will be a short delay (2 seconds) before the reader ready lamp illuminates. This delay is to allow all slack to be removed from the tape before drive commands are applied. When the ready lamp is illuminated, the system is ready for drive commands (read or wind). Both may be pulse or level commands.

4.2 LEVEL READ/WIND OPERATION

A level command for read operation will cause data to be read at the data rate selected (Section III). For wind operation, speed will always be 600 CPS. Refer to Figure 4-1.

4.3 PULSE READ/WIND OPERATION

A pulse width of 10 μ sec or longer will cause data to be transferred at the rate up to 600 CPS for read or wind operation. Refer to Figure 4-2.

4.4 READ (WIND) DIRECTION CHANGE

When a direction change is sensed by the system, during a READ or WIND operation, a small time delay is initiated. During this delay, the data buffer, which may contain as many as 180 characters, is emptied. The data buffer is then reloaded with data in the new direction selected. While the buffer is being emptied and then reloaded, the microprocessor keeps track of the data load pointer (L) which is incremented or decremented accordingly, making certain no character is dropped. DATA AVAILABLE+ is held inactive during this process. The time delay involved in a direction change varies, depending on the buffer content and the inertia load, from an average of 1 to 2 seconds.

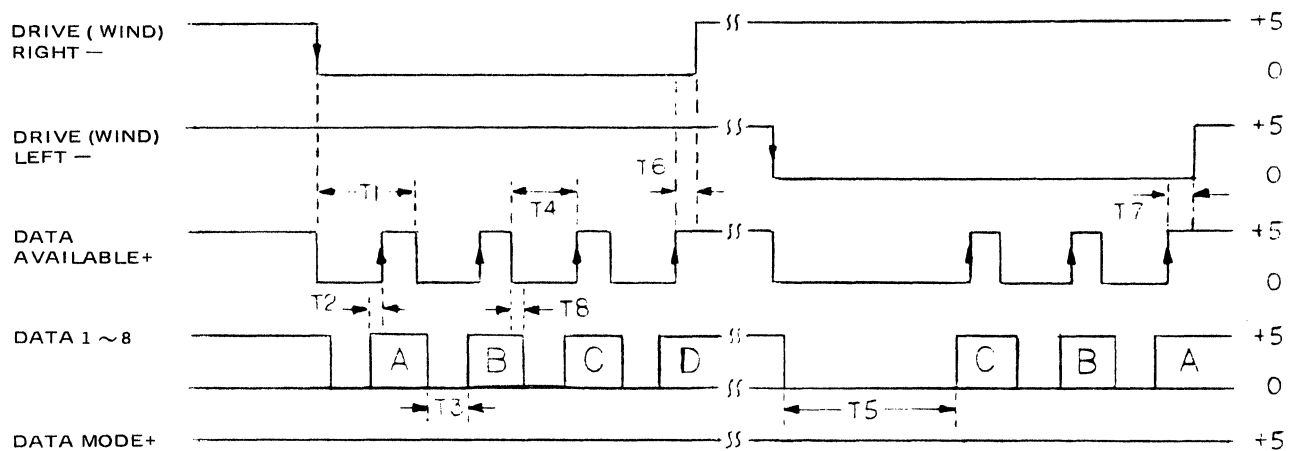

FIGURE 4-1 SPOOL MODE TIMING DIAGRAM (LEVEL OPERATION)

NOTES

- (1) T1 5 msec for 200 CPS, 3.3 msec for 300 CPS and 1.6 msec for 600 CPS.
T1 Approximately 1.6 msec for a WIND operation (600 CPS).
- (2) T2 100 μ sec typical
- (3) T3 Duration for data lines to be reset to zero.
- (4) T4 Timer delay (approximately 4 msec for 200 CPS, 2.5 msec for 300 CPS, and 1 msec for 600 CPS)
- (5) T5 Time delay during READ direction change (2 sec worst case).
- (6) T6 Less than 700 μ sec to stop-on-character.
- (7) T7 Less than 700 μ sec to stop-on-character.
- (8) T8 Approximately 100 μ sec.
- (9) DATA MODE should remain constant throughout a READ operation.

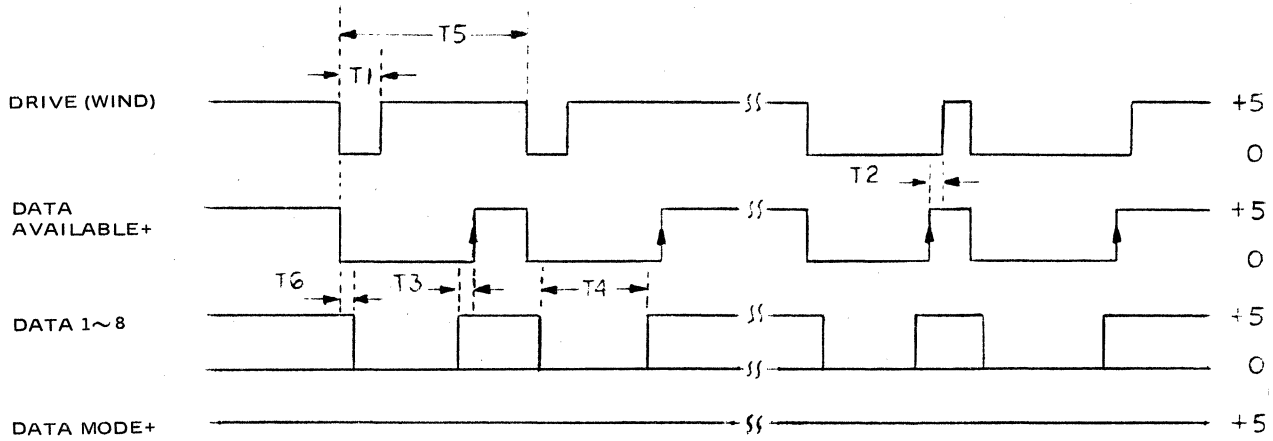

FIGURE 4-2 PULSE DRIVE TIMING DIAGRAM

NOTES

- (1) T1 10 μ sec minimum.
- (2) T2 Less than 700 μ sec to stop-on-character.
- (3) T3 Approximately 100 μ sec.
- (4) T4 Duration for data lines to be reset to zero.
- (5) T5 Greater than 3.3 msec for 300 CPS read, 5 msec for 200 CPS, and 1.6 msec for 600 CPS read.
- T5 Greater than 1.6 msec for WIND operation.
- (6) T6 Approximately 100 μ sec.

4.5 STOP-ON-CHARACTER TIMING CRITERION

During a READ or WIND operation, valid data is presented approximately 100 μ sec before the DATA AVAILABLE+ signal becomes true (positive or negative true, as selected). It is suggested that the leading edge of the DATA AVAILABLE+ signal be used to latch data. To stop-on-character, a DRIVE command (READ or WIND) must be removed within 700 μ sec of when the DATA AVAILABLE+ signal becomes true. A DRIVE command not removed within 700 μ sec will cause the next character to be sent.

4.6 LOOP MODE

The loop mode enables the user to read a short loop of tape. When this mode is selected (LP switch down), the stepper motor is energized during a READ operation while the servo motors are disabled. Receiving a READ command will cause data to be transferred at a rate of up to 200 CPS. For each READ direction change, a time delay of approximately 0.5 seconds is observed, during which the DATA AVAILABLE+ signal is kept inactive.

4.7 DATA HANDLING

Two 8-bit registers, inside the microprocessor, are used to maintain data flow continuity. One register, known as data fetch pointer (P), keeps track of the memory location from where data was last fetched. Depending upon the reading direction, the register content will either be incremented or decremented. The other registers, data load pointer (L), maintains the memory location of the last character saved.

The data buffer is said to be full when it contains 180 or more characters, $(L-P) \geq 180$. When the microprocessor senses a full buffer, the motor drive signal is disabled and the dynamic brakes applied, bringing the motors to a smooth stop.

When that data buffer memory holds 25 or less characters, $(L-P) \leq 25$, the microprocessor generates a move command. This command moves the tape at a predetermined speed, filling the buffer. The tape servoing speed is properly selected and the user will observe no drop in data rate for either a READ or WIND operation.

4.8 INTERRUPT DRIVEN LOGIC

Drive commands applied to the 760 Reader/Spooler are processed on a priority interrupt basis (See Table 4-1). An interrupt polling routine is set up to establish a READ (WIND) RIGHT operation as having a higher priority than a READ (WIND) LEFT operation.

TABLE 4-1 INTERRUPT PRIORITY

INTERRUPT PRIORITY	ACTION TAKEN BY MICROPROCESSOR	INTERRUPT CAUSED BY
1	PROCESS SPROCKET INTERRUPT	SPROCKET SIGNAL
2	PROCESS READ RIGHT INTERRUPT	DRIVE RIGHT -
3	PROCESS WIND RIGHT INTERRUPT	WIND RIGHT -
4	PROCESS READ LEFT INTERRUPT	DRIVE LEFT -
5	PROCESS WIND LEFT INTERRUPT	WIND LEFT -

Whenever a system interrupt is sensed, the microprocessor scans all drive lines, according to priority, to determine which causes the interrupt. This information is then saved in the flag register, which is constantly updated for future reference with every interrupt serviced.

Figure 4-1 illustrates the interrupt handling flow diagram.

4.8.1 SPROCKET INTERRUPT

The sprocket signal derived from the moving tape is sensed by the microprocessor as an external interrupt.

The leading edge of the sprocket signal sets a flip-flop, acknowledging the interrupt. Data appearing at the data bus is then read and stored in the data buffer at the memory location specified by data load pointer (L). For every sprocket signal detected, (L) is either incremented or decremented, depending upon the READ direction. Upon exit from the sprocket subroutine, the flip-flop is reset to accommodate the next sprocket interrupt.

To improve data integrity, every data will be read twice and compared for every sprocket detected. Data will be stored only if comparison is good.

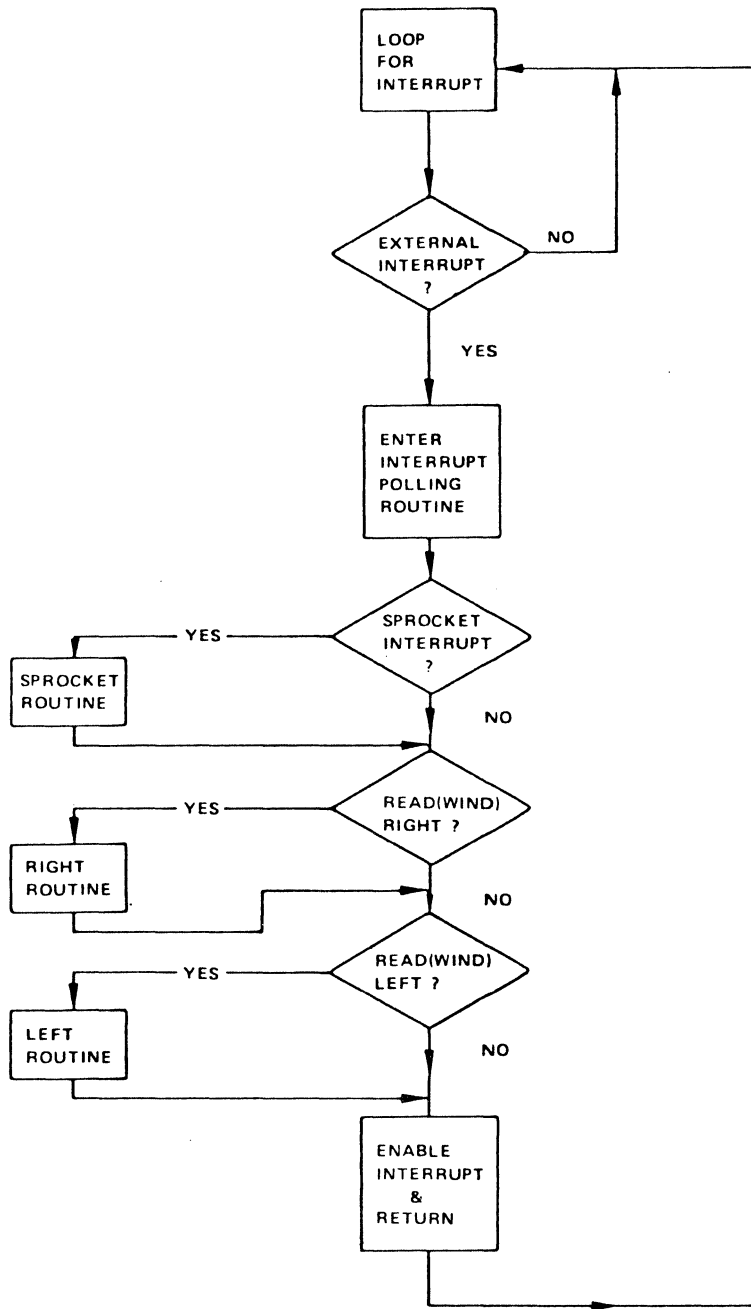

INTERRUPT HANDLING FLOW DIAGRAM

FIG. 4-3

4.8.2 READ RIGHT INTERRUPT

The READ RIGHT interrupt is produced by the DRIVE RIGHT-signal. When this interrupt occurs, the DATA AVAILABLE+ signal is forced low. If the buffer is not empty at this time, $(L-P) > 0$, data is fetched from the buffer, saved in a temporary storage register, and the data fetch pointer (P) is decremented.

4.8.3 WIND RIGHT INTERRUPT

A WIND RIGHT interrupt is handled the same as a READ RIGHT interrupt (See Figure 1.5) except that the timer is set to generate 1.6 msec delay to provide a data rate of 600 CPS.

4.8.4 READ LEFT AND WIND LEFT INTERRUPTS

These interrupts are processed the same as the READ RIGHT and WIND RIGHT interrupts (See Sections 4.8.2 and 4.8.3) except for the following:

- (1) A move left command is generated if the buffer memory contains 25 or less characters, i.e. $(L-P) \leq 25$.
- (2) The data fetch pointer (P) is incremented.

4.9 SPECIAL BUILT-IN FEATURES

4.9.1 PARITY CHECKING

Parity checking is provided only for EIA to ASCII code conversion. During conversion EIA244 to ASCII odd parity is checked. EIA358 to ASCII even parity will be checked. If a parity error is detected, all lamps in LED array will blink. For switch setting see Section III Operator Instructions.

4.9.2 BAD TAPE DETECTION

If the tape in use is torn, or sprocket holes are elongated beyond internal compensation, the reader will halt with indicator LED blinking.

4.10 SERIAL OPERATION (RS232)

For serial operation, be sure that all switches are set for the serial mode of operation. (See Section III - Operator Instructions). Baud rates, I/O protocol and hand shaking signals are switch selectable and must conform to user equipment.

Load tape into read head and close cover. Turn power on. There will be a short delay, approximately two (2) seconds, before the reader ready lamp illuminates. This delay is to allow all slack to be removed from the tape before drive commands are applied. When the ready lamp illuminates, the reader is ready to accept drive commands.

NOTE: PROTOCOL - (See operator instructions)

In the serial mode of operation the 760 Series Reader will recognize two (2) levels of protocol. Both are explained below.

4.10.1 LEVEL I PROTOCOL

This protocol is based on the use of the control signal CTS to start and stop data transmission.

4.10.2 LEVEL II PROTOCOL

This protocol provides communication capabilities between the reader and user equipment.

Control commands are listed below. These are firmware functions and may be described by the user.

Read Right	(cntrl Q)	11 hex or 91 hex
Read left	(cntrl H)	08 hex or 88 hex
Stop	(cntrl S)	13 hex or 93 hex
Single step right	(R)	D2 hex or 52 hex
Single step left	(L)	CC hex or 4C hex
Set load point	(ESC)	10 hex or 98 hex
Return to load point	(cntrl W)	17 hex or 50 hex

NOTE: Read speeds, right or left will be at the baud rate selected up to 600 CPS.

Return to load point positions the first character out of the buffer to its original start position. This applies to a start in either direction.

SECTION V

INTERFACE

5.1 PARALLEL I/O

The Series 700 parallel I/O provides for two (2) parallel connectors. One for EECO compatability (J5 - See Table 5-2), the other for Decitek REMEX (J1 - See Table 5-1). Both are TTL compatible. Eight (8) lines provide punched tape data output, four (4) other provide for reader status and handshaking. User control is provided through four (4) input lines. Two (2) DB25 connectors located on the rear panel provide for customer connections. J5 is a DB25S connector (female). J1 is a DB25P (male) connector.

- 5.1.1 Interface cable should not exceed 10 feet. Wire should be size 22 AWG. For noise immunity, use twisted pair or shielded cable with proper grounding at both cable ends.

5.1.2 PARALLEL INPUT SIGNALS

DATA MODE* (J1 ONLY)

This signal determines the polarity of the output data from the unit. A true input on DATA MODE+ will cause "positive true" data to be output, while a false input will cause "negative true" data to be output. This signal is true if left floating with no input.

A false signal is greater than or equal to zero, and less than or equal to 0.4V ($0.0V \leq \text{False} \leq 0.4V$).

A true signal is greater than or equal to 2.4V and less than or equal to 5.0V ($2.4V \leq \text{True} \leq 5.0V$).

*This signal will only effect data polarity if data mode is set for external selection. (See para. 3.2.3)

DRIVE RIGHT – (LEFT–) (J1, J5)

These signals command the 760 to read tape either in a left-to-right (DRIVE RIGHT –) or right-to-left (DRIVE LEFT –) direction. The data transfer rate is selectable at 200, 300, 600 CPS for the spool mode, and 200 for loop mode. These are active low signals.

WIND RIGHT – (LEFT–) (J1, J5)

In the spool mode, these signals cause the unit to wind tape either in a left-to-right (WIND RIGHT –) or right-to-left (WIND LEFT –) direction at a speed of approximately 600 CPS.

In the loop mode, these signals cause the unit to read at a rate of 200 CPS (maximum).

These are active low signals.

Logic connector J1 provides the user with I/O interfacing signals as shown in Table 5-1.

<u>PIN NO.</u>	<u>INPUT SIGNALS</u>	<u>OUTPUT SIGNALS</u>
1		DATA BIT 1 ± (LSB)
2		DATA BIT 2 ±
3		DATA BIT 3 ±
4		DATA BIT 4 ±
5		DATA BIT 5 ±
6		DATA BIT 6 ±
7		DATA BIT 7 ±
8		DATA BIT 8 ± (MSB)
9		DATA AVAILABLE
10	DATA MODE	
11		LOGIC GROUND
12		LOGIC GROUND
13		LOGIC GROUND
14		READER READY
15	-----	
16	DRIVE RIGHT-	
17	DRIVE LEFT-	
18	-----	
19	-----	
20	WIND RIGHT-	
21	WIND LEFT-	
22	-----	
23	-----	
24	-----	
25	-----	

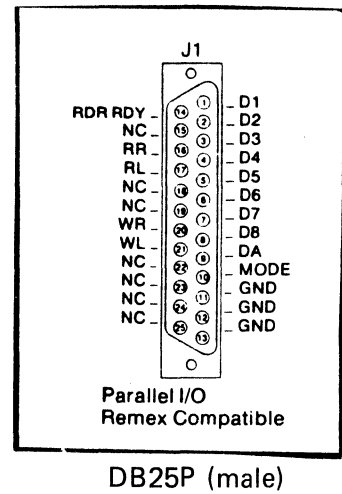

TABLE 5-1 LOGIC CONNECTOR J1

Logic connector J5 provides the user with I/O interfacing signals as shown in Table 5-2.

<u>PIN NO.</u>	<u>INPUT SIGNALS</u>	<u>OUTPUT SIGNALS</u>
1	-----	
2	WIND RIGHT-	
3	WIND LEFT-	
4	DRIVE RIGHT-	
5	DRIVE LEFT-	
6		READER READY
7	-----	
8	-----	
9		READ CLOCK
10		DRIVE ACKNOWLEDGE
11		DATA BIT 1 ± (LSB)
12		DATA BIT 2 ±
13		DATA BIT 3 ±
14		DATA BIT 4 ±
15		DATA BIT 5 ±
16		DATA BIT 6 ±
17		DATA BIT 7 ±
18		DATA BIT 8 ± (MSB)
19	-----	
20	-----	
21	-----	
22	LOGIC GROUND	
23	LOGIC GROUND	
24	LOGIC GROUND	
25	LOGIC GROUND	

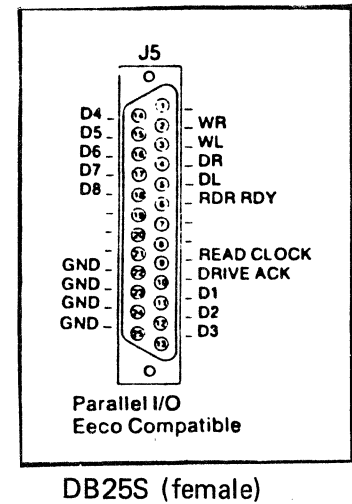

TABLE 5-2 LOGIC CONNECTOR J5 EECO

5.1.3 PARALLEL OUTPUT SIGNALS

DATA (X = 1 – 8) (J1, J5)

These signals are the data output from channels 1–8 and can be either “positive true” or “negative true,” depending on the DATA MODE+ input signal, or depending on S2-5 and S2-6 switch settings (see para. 3.2.3).

“Positive true” signals = $2.4\text{ V} \leq \text{True} \leq 5.0\text{V}$
= $0.0\text{ V} \leq \text{False} \leq 0.4\text{V}$

“Negative true” signals = $0.0\text{V} \leq \text{True} \leq 0.4\text{V}$
= $2.4\text{V} \leq \text{False} \leq 5.0\text{V}$

DATA AVAILABLE (J1 ONLY) and read clock (J5 ONLY).

This signal indicates when DATA X are valid. With jumper installed, between pins 1 and 16 of E1, this signal is:

$2.4\text{V} \leq \text{True} \leq 5.0\text{V}$ and $0.0\text{V} \leq \text{False} \leq 0.4\text{V}$

Data will be valid whenever this signal is true. It is recommended that any external data latching should be performed on the positive going transition of this signal. For systems requiring a DATA AVAILABLE– or read clock– signal, remove jumper E1, in which case the signal will be $0.0\text{V} \leq \text{True} \leq 0.4\text{V}$. Refer to Section 3.3 for jumper location.

READER READY (J1, J5)

This signal indicates the unit is ready to perform a READ and spool, WIND and spool, or loop/READ operation. With jumper in pins 3 and 14 of E2 removed, this signal is:

$0.0\text{V} \leq \text{True} \leq 0.4\text{V}$ and $2.4\text{V} \leq \text{False} \leq 5.0\text{V}$

For READER READY– to be true, the power must be on the tape hold-down cover closed. For READER READY+, install jumper between pins 3 and 14 of E2. Refer to Section 3.3 for jumper location.

The READER READY signal will be negated when the end-of-tape situation is detected.

DRIVE ACKNOWLEDGE (J5 ONLY)

This output line advises that DRIVE command has been received and acted upon. Refer to Section 3.3 for jumper location to select polarity.

RUN STATUS (J5 ONLY)

This signal is a level output either high or low (selectable - see Section 3.31) and indicates power on.

5.2 SERIAL I/O

The serial interface for the Series 700 Readers and Reader/Spoolers provide full duplex RS232C through a DB25S I/O connector at the rear of the reader (J2). Provisions for current loop are also provided. (See Table 5-3)

- 5.2.1 The serial interface cable should not exceed 50 feet in length. Wire should be size 22 AWG. For noise immunity use twisted pair or shielded cable with proper grounding at both cable ends.

LOGIC CONNECTOR J2 (SERIAL I/O – RS232)

Table 5-3 presents the I/O signals available at logic connector J2.

<u>PIN NO.</u>	<u>INPUT SIGNALS</u>	<u>OUTPUT SIGNALS</u>
1	-----	CHASSIS GROUND
2		TRANSMITTED DATA
3	RECEIVED DATA	
4		REQUEST TO SEND
5	CLEAR TO SEND	
6	DATA SET READY	
7		LOGIC GROUND
8	DATA CARRIER DETECTED	
9		
10		
11	-----	
12	Tx LOOP	
13	Rx LOOP	
14	-----	TRANSMIT CLOCK
15	-----	
16	-----	
17	-----	
18		
19	Rx LOOP	
20		DATA TERMINAL READY
21	-----	
22	-----	
23	Tx LOOP	
24	-----	Tx LOOP
25		Rx LOOP

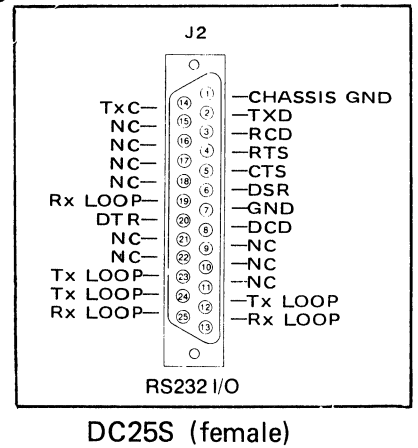

TABLE 5-3 LOGIC CONNECTOR J2

5.2.2 SERIAL INPUT SIGNALS

RECEIVED DATA (J2-3)

Data sent from the host computer is received by the 760 Reader/Spooler on this input line. Can be configured to become transmit data using switch S4. Refer to Section 3.2.4.4.

CLEAR TO SEND (J2-5)

This line must be active (AT + 12V) in order for the data transmitter to operate. This signal can be pulled up to +12V by closing switch S3-2.

DATA SET READY (J2-6)

This general purpose input line indicates that the host computer is ready to communicate. By closing switch S3-3 the line can be internally enabled.

DATA CARRIER DETECTED (J2-8)

The data receiver can operate only when this signal is active (AT + 12V). This line is enabled by closing switch S3-1.

Tx LOOP (J2-12)

This input signal indicates the loop return path for 20 ma TRANSMITTED DATA, when unit is operated as passive system.

Rx LOOP (J2-13)

This input signal indicates the loop return path for 20 ma RECEIVED DATA, when unit is operated as passive system.

Rx LOOP (J2-19)

This input pin provides the completed loop path for 20 ma RECEIVED DATA, when unit is operated as an active system. (See Figure 5-1)

Tx LOOP (J2-23)

This input pin provides the completed loop path for 20 ma TRANSMIT DATA, when unit is operated as an active system. (See Figure 5-1)

5.2.3 SERIAL OUTPUT SIGNALS

TRANSMITTED DATA (J2-2)

Data is transferred from the 760 Reader/Spooler to the host computer via this output line. Can be configured to become receive data using switch S4. Refer to Section 3.2.4.4.

REQUEST TO SEND (J2-4)

This general purpose output signal demonstrates that new data can be received.

Rx LOOP (J2-25)

This line indicates the loop path for 20 ma RECEIVED DATA.

Tx LOOP (J2-24)

This line indicates the loop path for 20 ma TRANSMITTED DATA.

DATA TERMINAL READY (J2-20)

This general purpose output signal advises that the 760 Reader/Spooler is ready to communicate.

TRANSMIT CLOCK (J2-14)

This signal is a X16 clock signal which, if needed, provides a synchronous clock pulse in reference to the transmitted data.

20 ma LOOP INTERFACE

For active operation (current supplied by 760 Reader/Spooler), S3-7 and S3-8 are closed.

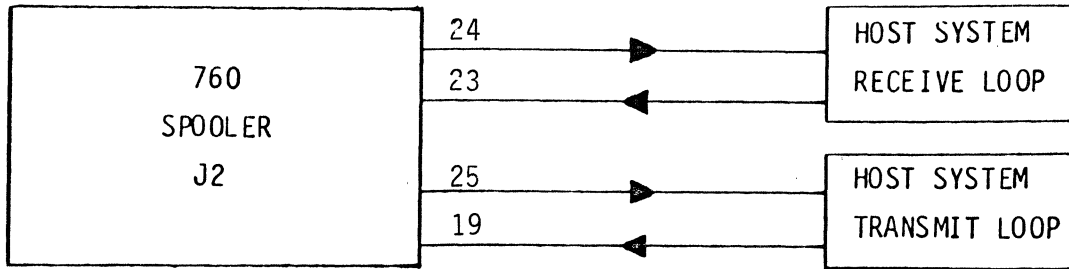

For passive operation (current supplied by host system), S3-7 and S3-8 are open.

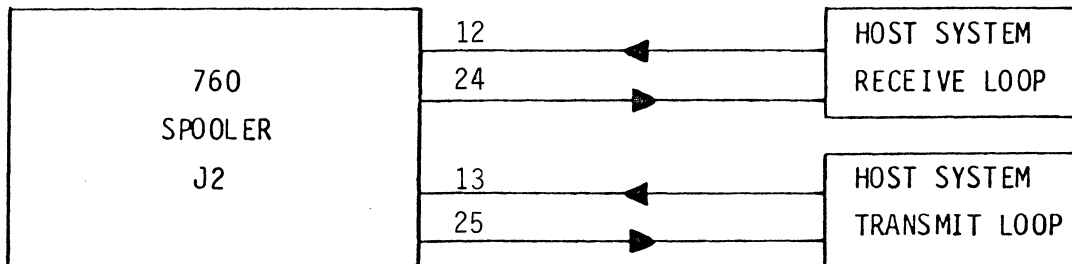

Consult Decitek Corporation for other loop current requirements and pin configurations.

Figure 5-1

SECTION VI
MAINTENANCE

6.1 PREVENTIVE MAINTENANCE

No preventive maintenance is required for the Series 700 Readers, except an occasional cleaning of the read head (40 hours recommended). A lint free cleaning kit was shipped with your readers. These kits are available from Decitek for \$3.00 each (P/N PL20598).

6.2 For routine maintenance, it is recommended that the reader be returned to the factory for service. The self test feature previously described in section III, para. 3.2.2 should be used to determine the faulty modules. Modules returned to the factory will be replaced immediately. Complete reader assembly returns will require two (2) weeks turn around.

6.3 Recommended Spare Parts:

762A9 & 762B9

<u>Module</u>	<u>Part No.</u>
Reader	261L7-001
Power Supply	PL40678
Servo	PL40671
Main PCB	PL60312

762C9

<u>Module</u>	<u>Part No.</u>
Reader	261L7-002
Power Supply	PL40686
Main PCB	PL60312

762D9

<u>Module</u>	<u>Part No.</u>
Reader	261L7-002
Power Supply	PL40681
Main PCB	PL60312

<u>Spooler Motors</u>	<u>Part No.</u>
Left	PL40647
Right	PL40648

NOTE: Serial Board for all models is Part No. PL40673

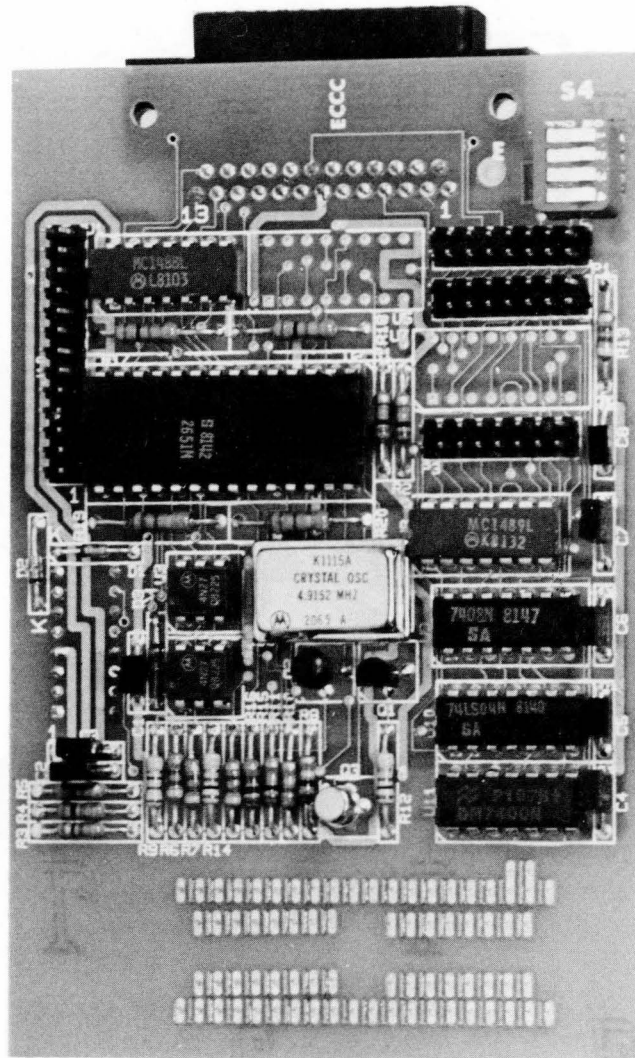

SERIAL PC BOARD ALL MODELS

PART NO. PL40673

Fig. 6-2

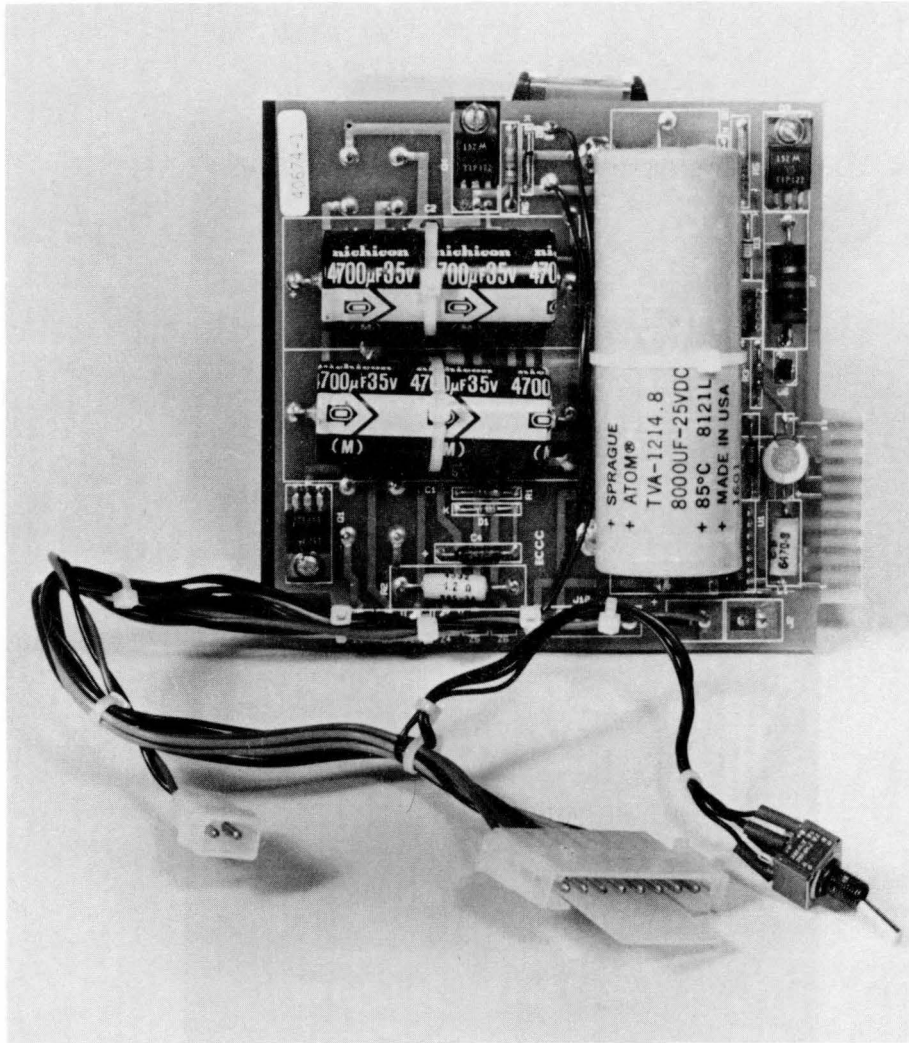

POWER SUPPLY

762A9, B9 - PART NO. PL40678

762C9 PART NO. PL40686

762D9 PART NO. PL40681

Fig. 6-3

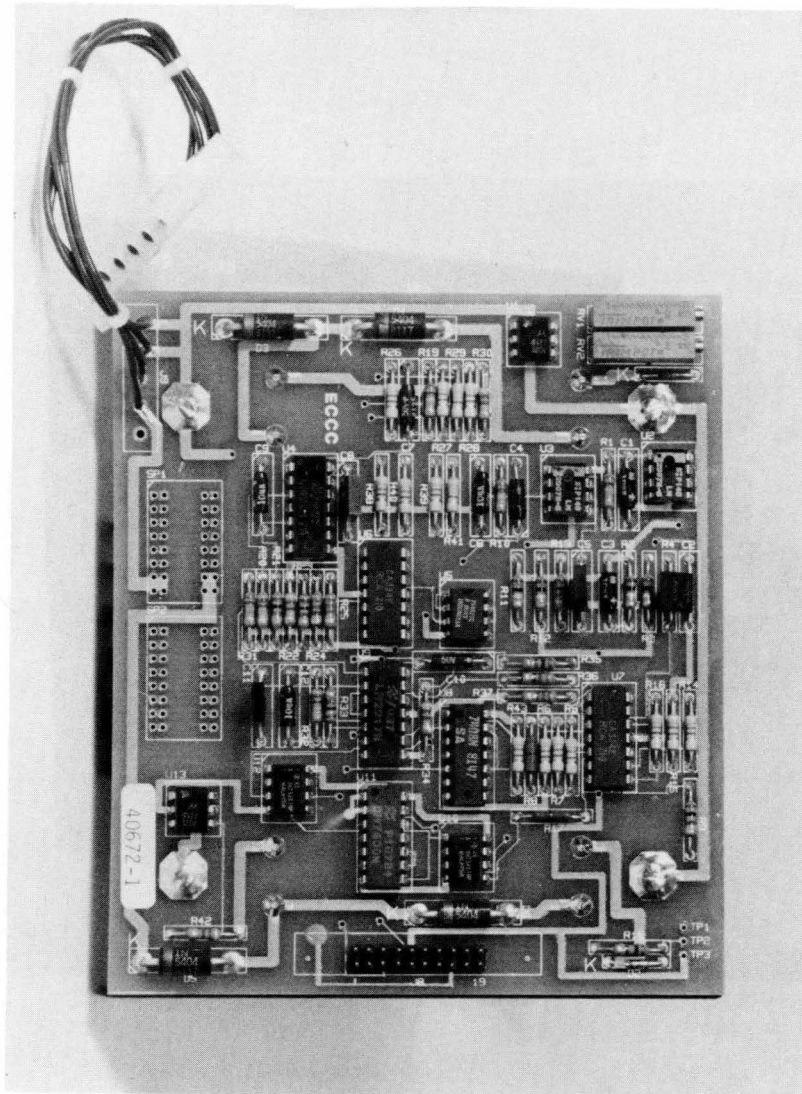

SERVO BOARD 762A9, B9

PART NO. PL40671

Fig. 6-4

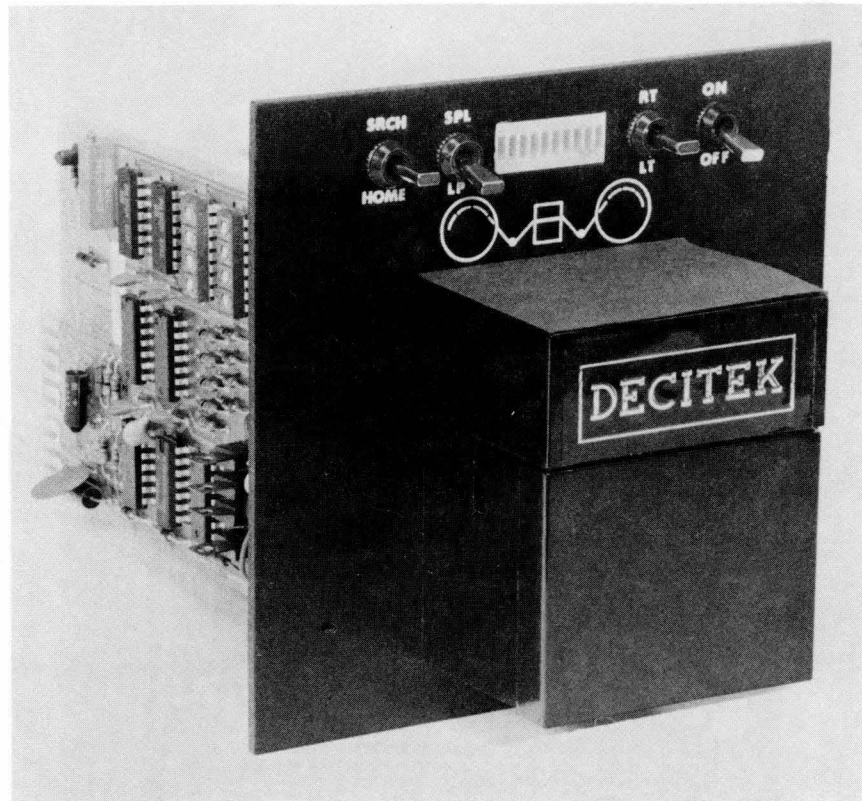

READER MODULE 762A9, B9

PART NO. 261L7-001

Fig. 6-5

6-6

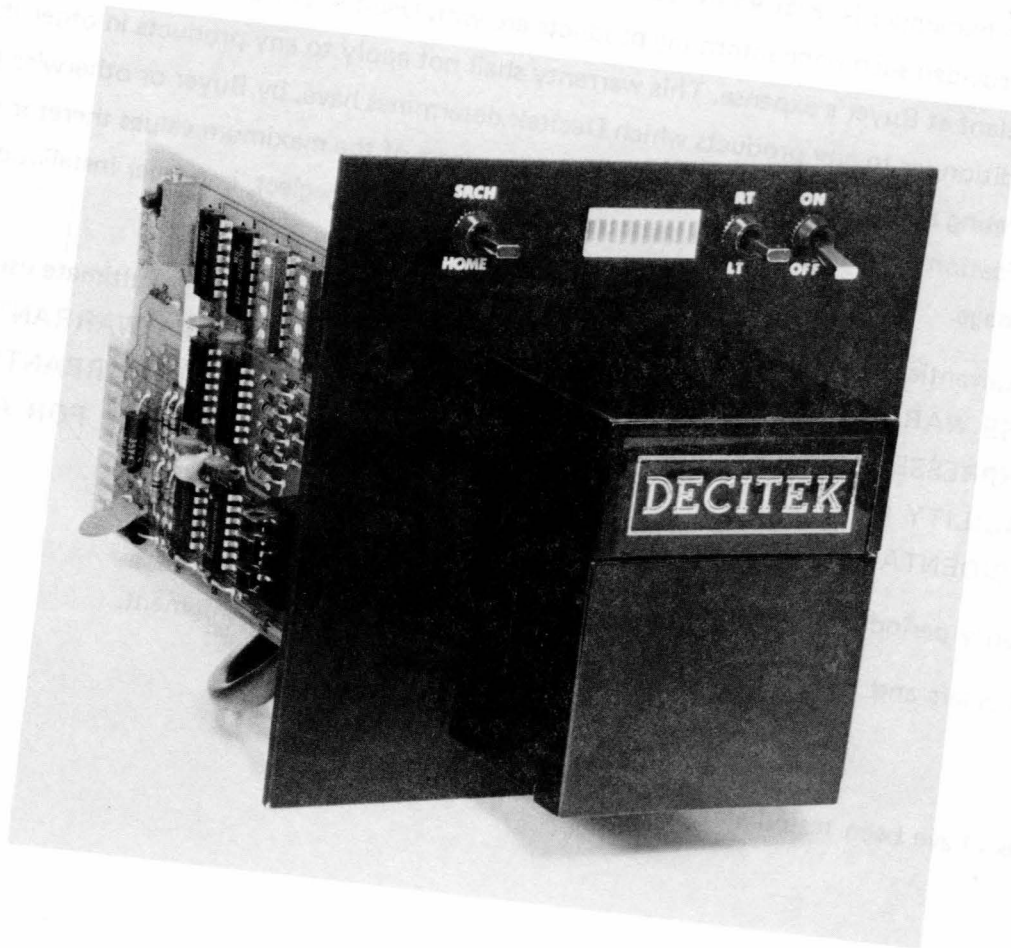

READER MODULE 762C9, D9

PART NO. 261L7-002

Fig. 6-6

6-7

**NEW
FROM
DECITEK**

Series 800

Tape Reader Emulators/Data Transporters



RE801



RE803



DT800

Applications:
DNC, NC to CNC Conversion,
Reader Replacement, Printer
Buffer, Data Logger, Portable
Data Transporter

SERIES 800 Tape Reader Emulators/Data Transporters

The DECITEK MODEL RE800 Paper Tape Reader Emulator is a zero error, direct replacement, for your existing paper tape reader.

The RE800 is microprocessor-based with CMOS memory expandable to 512K bytes (4,000 feet of tape) and has battery backup. The emulator is available in standard 5¼" x 19" or 8¾" x 19" rack mount versions or packaged in its own enclosure.

The RE800 may be loaded directly from existing tape preparation systems which support a communication capability or from a portable loader. Input to the emulator is through one of two serial ports. The connector located on the rear panel allows bidirectional communication and is ideal for DNC applications. The connector on the front panel provides easy access for a portable loader. Data may be loaded at any rate from 50 to 19.2K baud.

Four memory areas are provided for program storage—the standard product has four (4) 16K byte sectors. These sector sizes may be arranged to meet your requirements.

A parallel port is located on the rear panel. This parallel port is interfaced directly to your existing machine control as if the reader was being replaced due to wear or failure. Installation requires simply connecting the emulator where the reader was previously connected and securing the mounting screws.

A 32-character LCD display is located on the front panel. The display provides procedural prompting during loading and start operations. When running it displays the data presently being acted upon by the machine control.

A function key pad is provided for the several operating modes.

Once data is loaded into the RE800 and the cycle start is selected, the emulator will respond to your control exactly like the reader it replaced. There will be no tape wear or moving part errors.

The DT800 is a lightweight battery-powered portable data transporter about the size and weight of your machinist handbook. It has bi-directional RS-232 communications capability to provide you with easy data transfers to or from your control, or to or from your computer. The standard DT800 has 128K bytes of solid-state memory (1,000 feet of tape), and is expandable to 256K.

For operation, the DT800 requires four standard AA batteries.

The DT800 is simple to use, and alleviates punching and reading paper tape. The price is simple also—it costs less than \$1,000.

RE800 Features

- Fault-free data storage (solid-state memory)
- Parallel interface for replacement of most existing tape readers

- Two serial ports with RS-232/TTY bi-directional communications capability
- Remote LOAD capability
- Battery-backed memory expandable to 512K bytes (4,000 feet of tape)
- Internal ASCII to EIA conversion
- Environmentally sound for your link to DNC
- Simplicity of operation

DT800 Features

- Battery-operated (no line cords)
- Hand-held and lightweight (approximately 4 lbs.)
- RTS, CTS, or XON; XOFF Protocol
- Memory expandable to 256K
- High thruput

Interface

Compatible with **REMEX, EECO, DECITEK, SLO SYN, Tally, Fanuc, Acra read.**

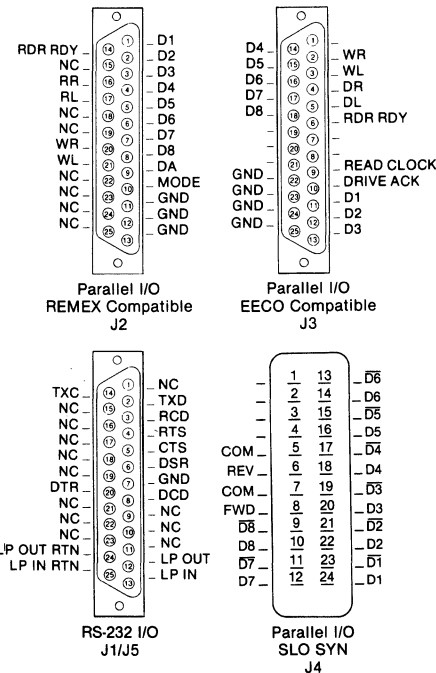

RE800 Specifications

Physical

Weight: 9 lbs.
Height: 5¼" or 8¾" RETMA standard
Width: 19"
Depth: 6½"

A.C. Supply

110V ± 10% 50/60 Hz
10 watts maximum
Environment: 0°C to 60°C

Performance

Parallel: 0-1000 cps-stop on character
Serial: 110 to 19.2K baud selectable
Search Speeds: 10 cps, 50 cps, 100 cps, 1000 cps

DT800 Specifications

Physical

Weight: 4 lbs.
Height: 2¼"
Width: 11"
Depth: 7½"

Power

4 AA batteries

Performance

Serial: RS-232/TTY
50 to 19.2K baud selectable

When reading matters

DECITEK

DECITEK CORP.

25 SOUTH STREET, HOPKINTON, MASSACHUSETTS 01748 (617) 435-6931

Telex 951811 DECITEK HOPT

DECITEK

25 South Street
Hopkinton, MA 01748

Telex: 951811

February 1987