

MPE V Backup and Recovery  
User's Guide

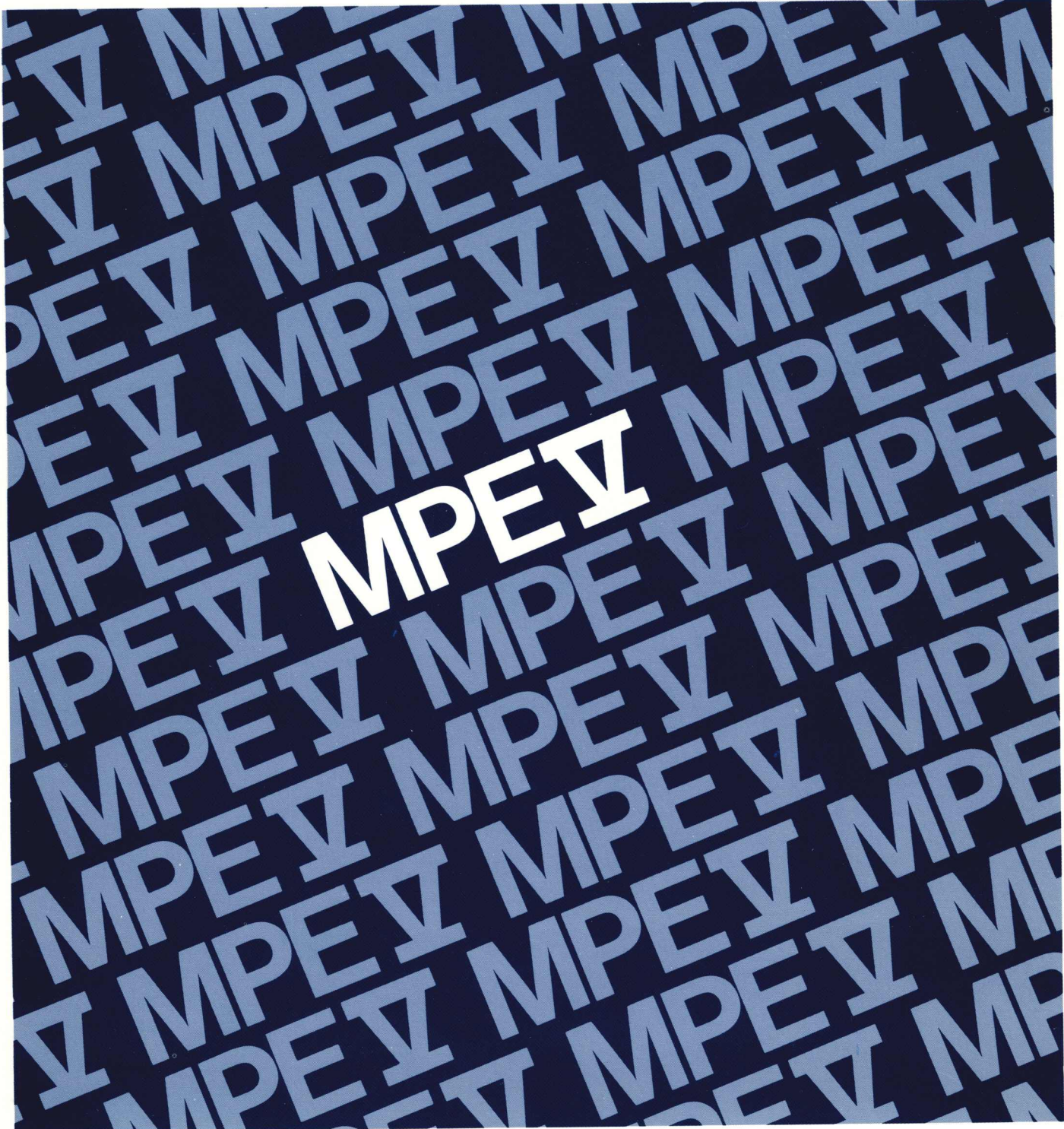

**HP 3000 Computers**

# **MPE V Backup and Recovery**

**Reference Manual**



Manual Part Number: 32033-90134  
U1088

Printed in U.S.A. June 1987

The information contained in this document is subject to change without notice.

**HEWLETT-PACKARD MAKES NO WARRANTY OF ANY KIND WITH REGARD TO THIS MATERIAL, INCLUDING, BUT NOT LIMITED TO THE IMPLIED WARRANTIES OF MERCHANTABILITY AND FITNESS FOR A PARTICULAR PURPOSE.** Hewlett-Packard shall not be liable for errors contained herein or for incidental or consequential damages in connection with the furnishing, performance or use of this material.

Hewlett-Packard assumes no responsibility for the use or reliability of its software on equipment that is not furnished by Hewlett-Packard.

This document contains propriety information which is protected by copyright. All rights are reserved. No part of this document may be photocopied, reproduced or translated to another language without the prior written consent of Hewlett-Packard Company.

© Copyright 1988 by HEWLETT-PACKARD COMPANY

# List of Effective Pages

---

The list of Effective Pages gives the date of the current edition, and lists the dates of all changed pages. Unchanged pages are listed as "ORIGINAL". Within the manual, any page changed since the last edition is indicated by printing the date the changes were made on the bottom of the page. Changes are marked with a vertical bar in the margin. If an update is incorporated when an edition is reprinted, these bars and dates remain. No information is incorporated into a reprinting unless it appears as a prior update.

First Edition            June 1987  
Update #1                October 1988

<b>Page</b>	<b>Effective Date</b>	<b>Page</b>	<b>Effective Date</b>
ii to iv .....	10/88	4-25 .....	10/88
v to vii .....	Original	5-1 .....	Original
viii to xiii .....	10/88	5-2 to 5-4 .....	10/88
xiv to 1-2 .....	Original	5-5 to 6-1 .....	Original
2-1 to 2-4 .....	10/88	6-2 to 7-5 .....	10/88
2-5 to 3-6 .....	Original	8-1 .....	Original
4-1 to 4-6 .....	10/88	8-2 .....	10/88
4-7 .....	Original	8-3 to A-2 .....	Original
4-8 .....	10/88	A-3 to B-2 .....	10/88
4-9 to 4-10 .....	Original	C-1 .....	Original
4-11 to 4-23 .....	10/88	C-2 to D-2 .....	10/88
4-24 .....	Original	Index .....	10/88

# Printing History

---

New editions are complete revisions of the manual. Update packages, which are issued between editions, contain additional and replacement pages to be merged into the manual by the customer. The dates on the title page change only when a new edition or a new update is published. No information is incorporated into a reprinting unless it appears as a prior update; the edition does not change when an update is incorporated.

The software code printed alongside the date indicates the version level of the software product at the time the manual edition or update was issued. Many product updates and fixes do not require manual changes, and conversely, manual corrections may be done without accompanying product changes. Therefore, do not expect a one-to-one correspondence between product updates and manual updates.

First Edition	.....	June 1987	.....	G.03.00
Update 1	.....	October 1988	.....	G.03.04

# Documentation Map

---

## MPE V MANUAL PLAN

### INTRODUCTORY LEVEL:

**GENERAL  
INFORMATION**  
Manual  
5953-7553

**GUIDE FOR THE  
NEW USER**  
32033-90009

**GUIDE FOR THE  
NEW OPERATOR**  
32033-90021

### STANDARD USER LEVEL:

**MPE V COMMANDS**  
Reference  
Manual  
32033-90006

**MPE V INTRINSICS**  
Reference  
Manual  
32033-90007

**MPE V UTILITIES**  
Reference  
Manual  
32033-90008

**SEGMENTER**  
Reference  
Manual  
30000-90011

**DEBUG/STACK DUMP**  
Reference  
Manual  
30000-90012

**FILE SYSTEM**  
Reference  
Manual  
30000-90236

### ADMINISTRATIVE LEVEL:

**MPE V SYSTEM  
OPERATION &  
RESOURCE MANAGEMENT**  
Reference  
Manual  
32033-90005

**ACCOUNT STRUCTURE  
AND SECURITY**  
32033-90136

**STORING AND  
RESTORING FILES**  
32033-90133

**BACKUP  
AND  
RECOVERY**  
32033-90134

### SUMMARY LEVEL:

**MPE QUICK  
REFERENCE GUIDE**  
32033-90023



# Conventions

---

NOTATION	DESCRIPTION
COMMAND	Commands are shown in CAPITAL LETTERS. The names must contain no blanks and must be delimited by a nonalphabetic character (usually a blank).
KEYWORD	Literal keywords, which you enter as you need them but exactly as specified, appear in CAPITAL LETTERS.
<i>parameter</i>	Required parameters, for which you must substitute a value, appear in <i>standard italics</i> and stand alone; they are not delimited by brackets or by braces.
[ <i>parameter</i> ]	Optional parameters, for which you may substitute a value, appear in <i>standard italics</i> and are delimited by brackets [ ].
[ ]	An element inside brackets in a syntax statement is optional. Several elements stacked inside brackets means the user may select any one or none of these elements. For example:  [A] User <i>may</i> select A or B or neither. [B]
{ }	When brackets are nested, parameters in inner brackets can only be specified if parameters in outer brackets or comma place-holders are specified. Example: [ <i>parm1</i> [, <i>parm2</i> [, <i>parm3</i> ]]] may be entered as:  <i>parm1,parm2,parm3</i> or <i>parm1,,parm3</i> or <i>,,parm3</i> ,etc.
{ }	When several elements are stacked within braces in a syntax statement, the user must select of of those elements. For example:  {A} {B} User <i>must</i> select A or B or C. {C}
...	A horizontal ellipsis in a syntax statement indicates that a previous element may be repeated. For example:  [, <i>itemname</i> ]...;

In additional, vertical and horizontal ellipses may be used in examples to indicate that portions of the example have been omitted.



# Conventions

---

## NOTATION

## DESCRIPTION (Continued)



Shaded delimiters appear in syntax diagrams to emphasize the role of the delimiter. Shading signifies that the delimiter preceding a parameter must be used for one of two reasons.

- (1) You have chosen to use the parameter, and the parameter requires the presence of the delimiter.
- (2) You have chosen to use more than one of the parameters in a chain of parameters that are connected by commas; and

You have chosen to leave gaps in the chain of parameters by omitting one or more intermediate parameters. The gaps created by the omission of the intermediate parameters must be delimited (separated) to maintain the correct (ordered) position of the remaining parameters.

```
itema[itemb][,itemc]
```

means that the following are allowed:

```
itema
itema, itemb
itema, itemb, itemc
itema, itemc
```





When necessary for clarity, the symbol  $\Delta$  may be used in a syntax statement to indicate a required blank or an exact number of blanks. For example:

```
SET (modified)] $\Delta$ (variable);
```



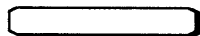

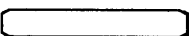
Within an example of interactive dialog, shaded characters indicate user input or responses to prompts.



The symbol  may be used to indicate a key on the terminal's keyboard. For example,  indicates the carriage return key.



Control characters are indicated by  followed by the character. For example,  Y means the user presses the control key and the character Y simultaneously.



Programmer's comments in listings appear within << >>.



Editor's comments appear in this form.

# Table of Contents

---

## Chapter 1 Backup and Disaster Recover Defined

System Backups .....	1-1
Disaster Recovery Plans .....	1-2

## Chapter 2 Managing Backups

What Should You Back Up? .....	2-1
Selecting a Backup Method .....	2-1
Using The STORE Program .....	2-2
The SYSDUMP Program .....	2-2
Scheduling Backups .....	2-2
Full and Incremental Backups .....	2-2
Selecting a Time for Backups .....	2-3
Maintaining a Tape Library .....	2-4
Maintaining a Stock of Backup Tapes .....	2-4
Keeping Records .....	2-4
Storing Backup Tapes .....	2-4
Setting Up a Tape Library .....	2-5

## Chapter 3 Preparing Your System for a Backup

Step 1: Notify Users That Backup Is About To Begin .....	3-1
Step 2: Prevent New System Activity .....	3-1
Step 3: Send A WARN Message To System Users .....	3-2
Step 4: Reply To Console Requests .....	3-3
Step 5: Temporarily Stop Jobs .....	3-3
Step 6: Send Another Warning .....	3-3
Step 7: Abort Any Remaining Sessions .....	3-4
Preparing Your System for Use after a Backup .....	3-4
1: Reset Job and Session Limits .....	3-4
2: Reset the Jobfence .....	3-5
3: Restart Jobs .....	3-5

## Chapter 4 Performing a Backup Using STORE

Standard STORE and TurboSTORE .....	4-1
Selecting TurboSTORE Backup Options .....	4-1
Backup Devices .....	4-2
Single Device .....	4-2
Sequential Devices .....	4-3
Parallel Devices .....	4-4
Parallel Device Pools .....	4-5

# Table of Contents, (Continued)

---

Interleaved Format .....	4-6
■ Planning Multiple-Device Backups .....	4-7
Choosing a Method .....	4-7
File Set Characteristics .....	4-7
Compatibility .....	4-7
Your System Configuration .....	4-8
Selecting Backup Devices .....	4-9
Preparing Your Backup Media .....	4-10
Preparing for a Single-Device or a Sequential Backup .....	4-11
Preparing Your Media for Parallel Devices and Parallel Device Pools .....	4-13
Storing Files .....	4-17
Issuing FILE Commands .....	4-17
FILE Commands for Automatically Assigned Devices .....	4-17
File Commands for Multiple Backup Devices .....	4-17
■ Backing Up Files with ACDs .....	4-18
Security Considerations .....	4-18A
Compatibility Considerations .....	4-18A
Backing Up Files to a Single Device .....	4-19
Full Backup .....	4-19
Incremental Backup .....	4-19
Backing Up Files to Sequential Devices .....	4-20
Full Backup .....	4-20
Incremental Backup .....	4-20
Backing Up Files to Parallel Devices .....	4-21
Full Backup .....	4-21
Incremental Backup .....	4-21
■ Backing up Files to Parallel Device Pools .....	4-22
Full Backup .....	4-22
Incremental Backup .....	4-22
Backing Up Files in Interleaved Format .....	4-23
Monitoring Your Progress .....	4-23
Responding to a Tape Request .....	4-23
Using the REPLY Command .....	4-23
Replying To Tape Requests for a Multiple-Device Backup .....	4-24
Responding to a NO WRITE RING Message .....	4-24
Progress Messages .....	4-24
Mounting Additional Tapes .....	4-25
Once the Backup is Complete .....	4-25

## Chapter 5

### Performing a Backup Using SYSDUMP

Preparing to Use SYSDUMP .....	5-1
Creating a Cold Load Tape .....	5-2
Performing a Full Backup .....	5-3
Performing an Incremental Backup .....	5-4
Other Uses of SYSDUMP .....	5-5
Performing a Carriage Return SYSDUMP .....	5-5
Performing a Future Date SYSDUMP .....	5-5
Performing a SYSDUMP Programmatically .....	5-6

# Table of Contents, (Continued)

---

## Chapter 6

### Performing a Backup Using TurboSTORE

Backing Up to Parallel Devices .....	6-1
Full Backup .....	6-1
■ Incremental Backup .....	6-3

## Chapter 7

### Using Backup Media to Recover From a System Failure

Reloading Files from STORE Backups .....	7-1
■ Reloading your System Configuration and System Files .....	7-1
Restoring User Files From Backup STORE Tapes .....	7-2
Using a Single Device .....	7-2
Using Sequential Devices .....	7-2
Selecting a RESTORE Method .....	7-3
Selecting Backup Devices .....	7-3
FILE Commands for Multiple Devices .....	7-4
Restoring Files from Your Most Recent Backup Tapes .....	7-4
Restoring Files from Full Backup Tapes .....	7-5
■ Reloading your System from a SYSDUMP Backup .....	7-5

## Chapter 8

### Disaster Recovery

Recovery Facilities .....	8-1
Private Recovery Facilities: Standby Sites and Fully-equipped Sites .....	8-1
Standby Sites .....	8-1
Fully-equipped Sites .....	8-2
Mutual Backup Arrangements .....	8-2
■ Hewlett-Packard Disaster Recover Service .....	8-3
Commercial Backup Companies .....	8-2
Computer Service Bureaus .....	8-2
Planning for Disaster Recovery .....	8-2
The Recovery Facility .....	8-3
System Compatibility .....	8-3
Disaster Notification and Response Time .....	8-3
Storing Backup Tapes .....	8-3
Testing Your Recovery System .....	8-3

# Table of Contents, (Continued)

---

## Appendix A

### Determining the Cause of STORE and RESTORE Errors

Viewing the Value of STOREJCW .....	A-2
Determining the Cause of an Error .....	A-2
Table A-1. STOREJCW Values .....	A-3

## Appendix B

### Command Syntax

:STORE Syntax .....	B-1
:RESTORE Syntax .....	B-2

## Appendix C

### STORE Tape Formats

Standard STORE Tape Formats .....	C-2
Interleave Tape Formats .....	C-4

## Appendix D

### STORE and RESTORE Versions

Running STORE.PUB.SYS .....	D-1
Standard STORE and Restore .....	D-1
TurboSTORE .....	D-1
Exiting STORE.PUB.SYS .....	D-2

## Appendix E

### Backup Device Configurations

.....	E-1
-------	-----

## Appendix F

### Managing Backup Devices

Replying to a Tape Request .....	F-2
Automatically Assigning Backup Devices .....	F-3
Mounting a Reel-to-Reel Tape .....	F-4
Unloading a Reel-to-Reel Tape .....	F-5
Preparing a Cartridge Tape .....	F-6
Loading a Cartridge Tape: HP 9140 and 9144 .....	F-7
Unloading a Cartridge Tape: HP 9140 and HP 9144 .....	F-8
Loading Cartridge Tapes: HP35401A .....	F-9
Unloading Cartridge Tapes: HP 35401A .....	F-10

# Illustrations

---

Figure 2-1	Full and Incremental Backups for a Month	2-3
Figure 4-1	Single-device backup.	4-2
Figure 4-2	Sequential Device Backup.	4-3
Figure 4-3	Parallel Device Backup.	4-4
Figure 4-4	Parallel Device Pool Backup.	4-5
Figure 4-5	Interleaved Tape Format	4-6
Figure 4-6	Full Backup Device Chart	4-9
Figure 4-7	Incremental Backup Device Chart	4-10
Figure 4-8	Correctly Labelled Tape.	4-12
Figure 4-9	Preparing for Single Device Backup.	4-12
Figure 4-10	Preparing Tapes for Sequential Devices	4-13
Figure 4-11	Preparing Tapes for Parallel Devices	4-15
Figure 4-12	Preparing Tapes for Parallel Device Pools	4-16
Figure 7-1	Restoring Files from a Single Device	7-2
Figure 7-2	Restoring Files from Sequential Devices	7-3
Figure 7-3	RESTORE Device Chart	7-3
Figure C-1	Standard STORE Tape Format	C-2
Figure C-2	STORE Tape Format with ACD Extensions	C-3
Figure C-3	Interleave Tape Format	C-4
Figure C-4	Interleave Tape Format with ACDs	C-5
Figure D-1	Standard STORE/RESTORE Banner	D-1
Figure D-2	TurboSTORE Banner	D-2

# Tables

---

Table 3-1.	Workstations	1-1
Table 3-2.	Operating Enviroment	1-1
Table 3-3.	Manual Conventions	1-1
Table 4-1.	:STORE Compatibility Chart.	4-8
Table A-1.	STOREJCW Values	A-3
Table E-1.	Backup Device Configurations	E-2

# Preface

---

This manual describes two important methods for protecting the information in your system: system backups and disaster recovery plans. It is written for System Managers, System Supervisors, and System Operators.

The manual consists of 8 chapters and 6 appendices. Its contents are:

- Chapter 1     Defines backup and disaster recovery
- Chapter 2     Describes how to manage system backups
- Chapter 3     Explains how to prepare your system for a backup
- Chapter 4     Describes how to perform a system backup with the STORE program
- Chapter 5     Describes how to perform a system backup with the SYSDUMP program
- Chapter 6     Describes how to perform a backup using TurboSTORE
- Chapter 7     Tells how to use backup media to recover from system failures
- Chapter 8     Describes how to prepare and implement a disaster recovery plan
- Appendix A   Tells how to determine the cause of a STORE or RESTORE error
- Appendix B   Describes STORE and RESTORE syntax
- Appendix C   Describes STORE tape formats
- Appendix D   Tells how to determine which version of STORE and RESTORE your system uses
- Appendix E   Contains recommended backup device configurations
- Appendix F   Contains a quick reference guide for managing backup devices

Before you begin to plan and perform system backups, you should have a working knowledge of several System Administrator functions. In particular, performing a system backup draws upon information presented in the following manuals:

- *Storing and Restoring Files (32033-90133)*
- *MPE V System Operation and Resource Management (32033-90005)*
- *MPE V Commands Reference Manual (32033-90006)*

---

## NOTE

In release G.03.00 and later versions of MPE V/E, there are two versions of STORE and RESTORE: standard STORE/RESTORE and TurboSTORE (HP30167A). Standard STORE/RESTORE is part of the Fundamental Operating System (FOS). TurboSTORE is a separate product. When installed on your system, TurboSTORE adds additional capabilities to the :STORE and :RESTORE commands. This manual describes both versions of STORE and RESTORE.

---



# Backup and Disaster Recovery Defined

---

System backups and disaster recovery plans provide two important methods of protecting the information stored in your computer system. This chapter gives you a brief, general description of both methods.

## System Backups

*Backing up* your system means regularly storing the information in your system to *back-up media*. Backup media are reel-to-reel tapes and serial discs (including cartridge tapes). Should your system experience a failure that causes it to lose information, you can reload that information from your backup media.

Planning, managing, and performing system backups are, perhaps, a System Administrator's most important tasks. Regularly scheduled, properly performed system backups guarantee that, in the event of an unexpected system mishap, the most current information is always available.

If a system failure does occur, the amount of data lost directly depends upon two factors:

- How recently the last backup was performed.
- The level of system activity since the last system backup.

As a System Supervisor, you are responsible for establishing a backup schedule that best meets the needs of all system users. Your schedule may include storing all files in a particular account every day, or storing only those files that have been added or modified since the last complete system backup.

As a System Operator, you are responsible for performing regular backups. Be sure to back-up all of the software used by the system, since you would use backup media to restore the system should it experience problems.

## Disaster Recovery Plans

Regular system backups protect the *information* in your system. However, natural and manmade problems such as smoke, noxious fumes, explosion, flood, earthquake, and sabotage threaten both your backup media and your system hardware. A *disaster recovery plan* protects the information in your system from such hazards by establishing procedures for duplicating your computer hardware and safely storing backup tapes. Although implementing a disaster recovery plan can be time-consuming and costly, saving important information from an unexpected disaster is worth the effort.

## Managing Backups

---

As a System Manager, you are responsible for managing backups. Your responsibilities include:

- Selecting backup methods
- Scheduling regular backups
- Establishing a backup tape library

Selecting backup methods and scheduling regular backups are important aspects of a System Manager's job. Standard procedures reduce the time necessary to perform backups and guarantee that the most recent system information is always available. A regular backup schedule reduces system recovery time.

An important part of planning and performing system backups is making sure that the resources you need are available and well-managed. Maintain a supply of backup media and labels, and establish procedures for identifying and storing backup tapes.

### What Should You Back Up?

To completely back up your system, you should store three types of information:

- User files. It is important to back up user files frequently, since they can be the product of several months or even years of labor and cannot otherwise be duplicated.
- System files. All system files are in groups within the SYS account; most system files are owned by the PUB group of the SYS account.
- The current system configuration. The system configuration includes system tables, queues, device I/O attachments, and other parameters.

You backup your system configuration and system files on a cold load tape. Depending upon the backup method chosen, you may backup your user files either at the end of the coldload tape or on separate STORE tapes. Backing up system configuration and system files separately from user files is to your advantage, because user files change daily while system configuration and system files change infrequently. Furthermore, you can avoid backing up any inadvertent corruption of system files.

## Selecting a Backup Method

You can use both the SYSDUMP and STORE programs to perform system backups. SYSDUMP can either back up just the system configuration or perform a complete system backup, including the system configuration, system files, and user files. STORE backs up only system and user files.

This gives you two ways of backing up your system. The first and simplest is to use SYSDUMP to do a complete system backup at regular intervals (for example, each day). The second and more common method is to use SYSDUMP to create a backup coldload tape to store the system configuration, and then use STORE to regularly back up files. Because system information seldom changes, you do not need to create backup cold load tapes daily. You should, however, back up user files each day.

## Using The STORE Program

If you have purchased TurboSTORE (available for MPE G.03.00 and later versions), there are several advantages to using it for your daily system backups. TurboSTORE reduces the time necessary to perform a backup by allowing you to store files to several similar devices at the same time. In addition, you can take advantage of the full speed of your backup devices by storing files in the special interleave format. Refer to Chapter 4 for complete descriptions of standard STORE and TurboSTORE options.

Since you cannot back up your system configuration with the STORE program, you must use the SYSDUMP program to create a coldload tape from which you can reload the system configuration. While you may use STORE to perform daily backups, you only need to create a coldload tape when the system configuration is changed.

## Using the SYSDUMP Program

Use the SYSDUMP program to create a cold load tape to complement a STORE backup, or to perform a complete system backup.

SYSDUMP *does not* support the quick methods of storing files supported by TurboSTORE. If you have many user files and fast peripherals, take advantage of the quicker TurboSTORE methods, and use SYSDUMP only to create cold load tapes. If you have only one backup device, you might choose to use SYSDUMP to perform a complete backup all at once.

## Scheduling Backups

There are two important considerations when planning a backup schedule:

- First, consider planning full and incremental backups to more efficiently duplicate the most recent system information.
- Second, schedule a regular time for performing backups.

## Full and Incremental Backups

There are two ways to perform a system backup. A *full backup* copies all files stored in your system whether or not any of the information in them has changed since the

last backup. An *incremental backup* copies only the files that have changed since the last full backup. A typical schedule calls for a full backup once a week and an incremental backup each remaining workday. If you follow such a schedule, you would lose no more than 24 hours worth of information should the system experience problems.

Figure 2-1 shows a sample backup schedule that combines both full and incremental (also called “partial”) system backups:

Sunday	Monday	Tuesday	Wednesday	Thursday	Friday	Saturday
					Full Backup	
	Incremental Backup	Incremental Backup	Incremental Backup	Incremental Backup	Full Backup	
	Incremental Backup	Incremental Backup	Incremental Backup	Incremental Backup	Full Backup	
	Incremental Backup	Incremental Backup	Incremental Backup	Incremental Backup	Full Backup	
	Incremental Backup	Incremental Backup	Incremental Backup	Incremental Backup	Full Backup	

Figure 2-1. Full and Incremental Backups for a Month

## Selecting a Time for Backups

It is best to perform backups when no one is using the system, such as at the end of the workday or later in the evening. Schedule the backup for the same time every day so users will know when to expect it and can plan ahead.

Be sure to schedule enough time for each backup. Full backups take more time and more media than incremental backups. An incremental backup a day or so after a full backup takes less time and fewer tapes than an incremental backup performed almost a week later. As the week progresses, there is more new information to store. If you perform a full backup on Friday, the first incremental backup on Monday may only take one tape and not much time. By Thursday, however, the day before the next scheduled full backup, an incremental backup may require several tapes and considerably more time.

## Maintaining a Tape Library

Establish a tape library for storing backup tapes and backup records. Include in your tape library:

- A large stock of certified scratch tapes to use for backups.
- A record of each tape's contents. Make sure that each tape has a label on it that lists its contents. It should be easy to find the backup tapes needed to restore the system in the event of a failure.
- A safe place to keep tapes. Always keep older backup tapes in case more recent tapes are bad.

## Maintaining a Stock of Backup Tapes

You need to maintain a large and easily-accessible stock of backup tapes, because you can never be sure exactly how many tapes you need before for each backup. The number of tapes you need depends upon whether you are performing a full or an incremental backup and how much data is stored on your system.

Using new tapes insures the best possible data integrity. Use used tapes only when they are in good condition and contain outdated information. The information on a used tape is outdated when the purge date on the label has passed. To help judge whether a used tape is in good condition, you can use the cycle field of the Hewlett-Packard standard sticky tape label to track the number of times a tape has been used. Tapes wear out and become unreliable after much use. To determine whether a tape is still usable, ask your System Manager, consult the manufacturer's recommendations, or have the tape certified.

## Keeping Records

Each time you create a backup tape, have the system print a report describing the tape's contents. Include the `SHOW=OFFLINE` parameter in your `:STORE` command. Refer to Chapter 4 for instructions. Use a `:FILE` command to redirect `SYSDUMP` output to a printer. Refer to Chapter 5 for instructions. File these reports in a special filing cabinet or attach them directly to the appropriate tape reel.

Label backup tapes when you use them, following the instructions in Chapter 4.

## Storing Backup Tapes

Backup tapes may be the only copy of the information stored in your system. When you need to restore information from backup tapes, you should be able to find easily the tapes you need. Establish a tape library to maintain complete records of your system's data.

## Setting Up a Tape Library

To set up a tape library:

- Obtain a substantial number of tapes. The exact number you need depends on the size of your system and the frequency of backups.
- Obtain a container such as a vault or metal cabinet or rack in which to store the backup tapes.
- Establish a control program for maintaining backup tapes for a specified length of time. It is important to keep backup tapes in case you need to restore your system and find that the most recent tapes are bad. In such a situation, you can use the previous tapes.
- Establish a cleaning and verifying schedule for the tape drives.
- As part of your disaster recovery plan, create a duplicate tape library in a safe, offsite location.

# Preparing Your System for a Backup

---

This chapter describes how to:

- Prepare your system for a backup
- Restore your system to its normal state once the backup is complete

## Preparing your System for a Backup

Although people can use the system while you perform a backup, MPE V/E stores only files that are not in use. Therefore, it is a good practice to close all files and log all users off the system before you begin a backup. To prepare for a backup, follow the steps below.

### Step 1: Notify Users That Backup Is About To Begin

About 15 minutes before you plan to begin the backup use the `:TELL` command to send a message asking all users to finish their work and log off the system. Enter the following command substituting the actual time that you plan to begin the backup for 18:00.

```
:TELL @S; BACKUP BEGINS AT 18:00. &  
PLEASE LOGOFF; &  
TELL YOUR QUIET NEIGHBORS.
```

### Step 2: Prevent New System Activity

You control the number of executing jobs and sessions with two commands: `:LIMIT` and `:JOBFENCE`. The `:LIMIT` command controls the number of jobs or sessions that execute concurrently. (The limits you set with the `:LIMIT` command cannot exceed the maximum job/session limit determined by your system configuration.)

The `:JOBFENCE` command lets you choose the priority jobfence—a number between 0 and 14 (inclusive). Each session and job logs on to the system with an input priority between 1 and 13 (inclusive); the default input priority for standard MPE V/E users is 8. In order for a session or job to execute, its input priority must exceed the current jobfence.



When you set the jobfence high, jobs with an input priority less than or equal to the jobfence enter the WAIT state. MPE V/E refuses attempts to initiate a session with an input priority that does not exceed the current fence. Users see the following message:

```
CANT INITIATE NEW SESSIONS NOW
```

If you set the jobfence to its highest possible value, 14, only users assigned System Manager (SM) or System Supervisor (OP) capability are able to logon. (System Managers and System Supervisors are the only users allowed to logon with the ;HIPRI parameter of the :HELLO and :JOB commands.) By setting the jobfence to 14, you prevent all other users from gaining access to the system during a system backup. Enter:

```
:LIMIT 0,0  
:JOBFENCE 14
```

To check the new job/sessions limits and the system jobfence enter:

```
:SHOWJOB STATUS
```

The last line of the message on your Console should exactly match the following example:

```
JOBFENCE= 14; JLIMIT= 0; SLIMIT= 0
```

If you see anything else, you made a mistake entering the :LIMIT and :JOBFENCE commands. Follow the instructions again.

### Step 3: Send A WARN Message To System Users

About 10 minutes before you plan to begin the backup, use the :WARN command to send a message to all users asking them to log off the system. Unlike the :TELL command, the :WARN command interrupts users working in quiet mode so that you can be sure they know about the impending backup. Enter the following command, substituting the time you intend to begin the backup for 18:00:

```
:WARN @S: BACKUP WILL BEGIN AT 18:00. &  
PLEASE LOG OFF
```

Now that everyone has been warned, find out who is still using the system. Enter:

```
:SHOWJOB JOB=CS
```

The system responds by listing all sessions. Since you have already told users about the backup once, and warned them again, most users should have ended their sessions. Periodically use the :SHOWJOB command to see who is still logged onto the system.

## Step 4: Reply To Console Requests

Before continuing with the backup, check whether there are any console requests pending. Enter:

```
:RECALL
```

If the system responds that there are NO REPLIES PENDING, skip to the next step. If there are console requests that you have not yet answered, respond to them now. Refer to Appendix F for information on answering tape requests. If you give users access to a device at this point, you may have to wait until they finish their work before you proceed with the backup.

## Step 5: Temporarily Stop Jobs

To check whether there are any jobs running on the system, enter:

```
:SHOWJOB JOB=@J
```

If you see a message stating that there are NO SUCH JOBS, or if the list contains no executing jobs (check the STATE column for EXEC), skip to the next step. If any jobs appear in the EXEC column, temporarily stop them. Use the :BREAKJOB command and the job numbers that appear in the first column of the job listing. For example:

```
:BREAKJOB #J465
```

Repeat the :BREAKJOB command for each executing job in the list. STORE does not copy files allocated to suspended jobs, thus your backup may be incomplete. Advise users not to schedule jobs during the time scheduled for backups.

When you have suspended all executing jobs, check their status by entering:

```
:SHOWJOB JOB=@J
```

Each job should now be listed as SUSP, or suspended. Jobs that have resources, for example tape drives, allocated to them do not suspend immediately; you may have to wait for them to suspend.

## Step 6: Send Another Warning

Check to see whether any users are still logged on to the system by entering:

```
:SHOWJOB JOB=@S
```

If there are any remaining sessions, besides your own, send them one last warning:

```
:WARN @S; LOG OFF NOW! BACKUP ABOUT TO BEGIN
```

## Step 7: Abort Any Remaining Sessions

Check once more whether all sessions (except your own) have logged off by entering:

```
:SHOWJOB JOB-@S
```

Either abort any sessions (other than your own) that are still executing, or check with the users and ask them once more to log off. To abort sessions, use the `:ABORTJOB` command and the session numbers that appear in the first column of the list. For example:

```
:ABORTJOB #S37
```

After you have aborted all sessions (except your own), issue a `SHOWJOB` command to check that all sessions are aborted. When the system responds that you are the only session on the system (as shown in the following example), you are ready to begin the backup.

JOBNUM	STATE	IPRI	JIN	JLIST	INTRODUCED	JOB NAME
#S184	EXEC		20	20	FRI 1:03P	OPERATOR.SYS
#J17	SUSP		10S	PP	FRI 5:02P	AJOB,MRS.T

```
2 JOBS:
```

```
  0 INTRO; 0 SCHEDULED
  0 WAIT;  INCL 0 DEFERRED
  1 EXEC;  INCL 1 SESSIONS
  1 SUSP
```

```
JOBFENCE= 14; JLIMIT= 0; SLIMIT= 0
```

## Preparing Your System for Use after a Backup

After a backup, allow users access to the system again. Perform the procedures in the following steps.

### 1: Reset Job and Session Limits

Reset the job and sessions limits to their original values. Enter the following command, substituting your original job limit for `j` and your original session limit for `s`:

```
:LIMIT j,s
```

To check that you've used the correct numbers, enter:

```
:SHOWJOB STATUS
```

The last line should report the correct job limit (`JLIMIT`) and (`SLIMIT`) for your system. If the values are incorrect enter the `:LIMIT` command again with the corrected values.

## 2: Reset the Jobfence

Reset the system jobfence to its original value. Enter the following command substituting the original jobfence for the letter f:

```
JOBFENCE f
```

To check that the jobfence is correct, enter:

```
SHOWOUT STATUS
```

If the JOBFENCE value is incorrect, enter the :JOBFENCE command with the correct value.

## 3: Restart Jobs

Restart any suspended jobs. To determine whether any jobs had been temporarily stopped, enter:

```
SHOWJOB
```

The system lists your session and any suspended jobs in the following way:

```
JOBNUM  STATE  IPRI  JIN    JLIST      INTRODUCED  JOB NAME
#S185   EXEC           20    20      FRI  1:03P  OPERATOR.SYS
#J17    SUSP           10S   PP      FRI  5:02P  AJOB,MRS.T
2 JOBS:
0 INTRO; 0 SCHEDULED
0 WAIT; INCL 0 DEFERRED
1 EXEC; INCL 1 SESSIONS
1 SUSP
JOBFENCE= nn; JLIMIT= nn; SLIMIT= nn
```

The example shows one suspended job (#J17). To restart that job, enter:

```
RESUMEJOB #J17
```

Repeat the :RESUMEJOB command for each job listed as SUSP. When you have done this for each suspended job, check that all have been restarted by entering:

```
SHOWJOB
```

The list should look nearly identical, except that jobs that were suspended before should now be listed as executing or EXEC:

JOBNUM	STATE	IPRI	JIN	JLIST	INTRODUCED	JOB NAME
#S185	EXEC		20	20	FRI 1:03P	OPERATOR.SYS
#J17	EXEC		10S	PP	FRI 5:02P	AJOB,MRS.T

2 JOBS:

0 INTRO; 0 SCHEDULED

0 WAIT; INCL 0 DEFERRED

2 EXEC; INCL 1 SESSIONS

0 SUSP

JOBFENCE= f; JLIMIT= j; SLIMIT= s

# Performing a Backup Using STORE

---

This chapter describes how to use STORE to perform system backups. It describes each of the following steps in detail:

- Selecting backup options
- Planning multiple-device backups
- Preparing your backup media
- Preparing your backup devices
- Storing files
- Monitoring your progress
- Unloading and storing your backup tapes once the backup is complete

Files are backed up either using a single device or multiple devices. The following discussion provides information on each of the available options.

## Standard STORE and TurboSTORE

There are two versions of STORE: standard STORE and TurboSTORE. Standard STORE is part of the MPE fundamental operating software. TurboSTORE is a product that you purchase separately from MPE. TurboSTORE adds options to the standard :STORE command that reduce the time it takes to perform system backups.

Refer to Appendix D, “STORE and RESTORE Versions” if you are unsure which version your system is running. Obviously, you can only use the TurboSTORE options if they are on your system.

## Selecting TurboSTORE Backup Options

Before you begin a backup with TurboSTORE, choose the backup options that you want to use.

## Backup Devices

- With standard STORE, you can use only a single device for backup. With TurboSTORE, you can choose to backup files to a single device or to multiple devices. The best way to use your backup devices depends upon your system configuration and the characteristics of the set of files you plan to store.

### Single Device

- When you use a single device, both standard STORE and TurboSTORE copy files to a single tape at a time. When standard STORE or TurboSTORE fill a backup tape, they prompt you to load a new tape. After you rewind and unload the first tape and load a second, standard STORE or TurboSTORE continue writing files until they store all of the qualified files. If your system contains many files, you may have to load several tapes onto the single device. Figure 4-1 illustrates a single-device backup.

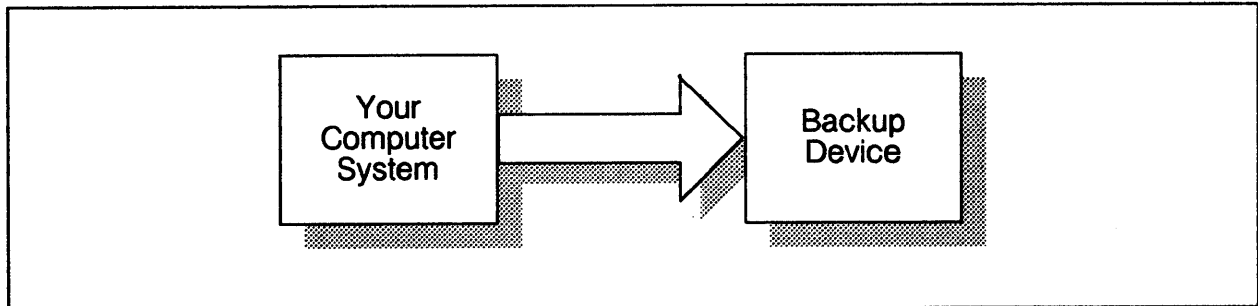

LG200021\_001

Figure 4-1. Single-device backup.

## Sequential Devices

One way to use multiple devices is to copy files sequentially to a group of identical backup devices, called a *device pool*. When TurboSTORE fills the first backup tape on the first backup device, it immediately begins writing files to a second tape on the second backup device. While TurboSTORE continues, the first tape rewinds; when it finishes, you can unload it and prepare the drive with a new tape. You do not lose the time necessary to rewind a tape and load a new one.

When TurboSTORE fills the first tape on the final tape drive, it begins copying files to the first device and continues to cycle through all the devices in the device pool until your backup is complete. Sequential backups provide a good use of your resources when your system has two backup devices. TurboSTORE lets you use a maximum of four sequential backup devices. Figure 4-2 illustrates the sequential device backup.

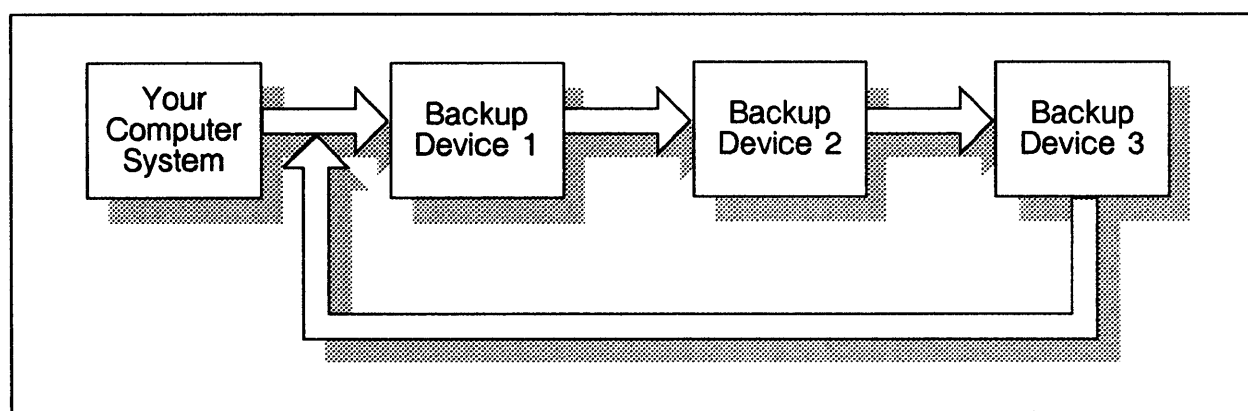

LG200021\_002

**Figure 4-2. Sequential Device Backup.**



## Parallel Devices

- When you copy files to a set of *parallel* devices, TurboSTORE partitions the files before beginning to store them, and copies files to multiple devices at the same time.
- For example, when you have four parallel devices, TurboSTORE partitions your files into 4 subsets. It copies files in the first subset to the first tape drive, copies files in the second subset to the second tape drive, and so on. When it fills a tape,
- TurboSTORE prompts you to mount another tape on the drive.

Depending upon the characteristics of your backup devices, backing up files to parallel devices can save even more time than using sequential devices. TurboSTORE lets you use a maximum of four parallel devices. Figure 4-3 illustrates parallel device backup.

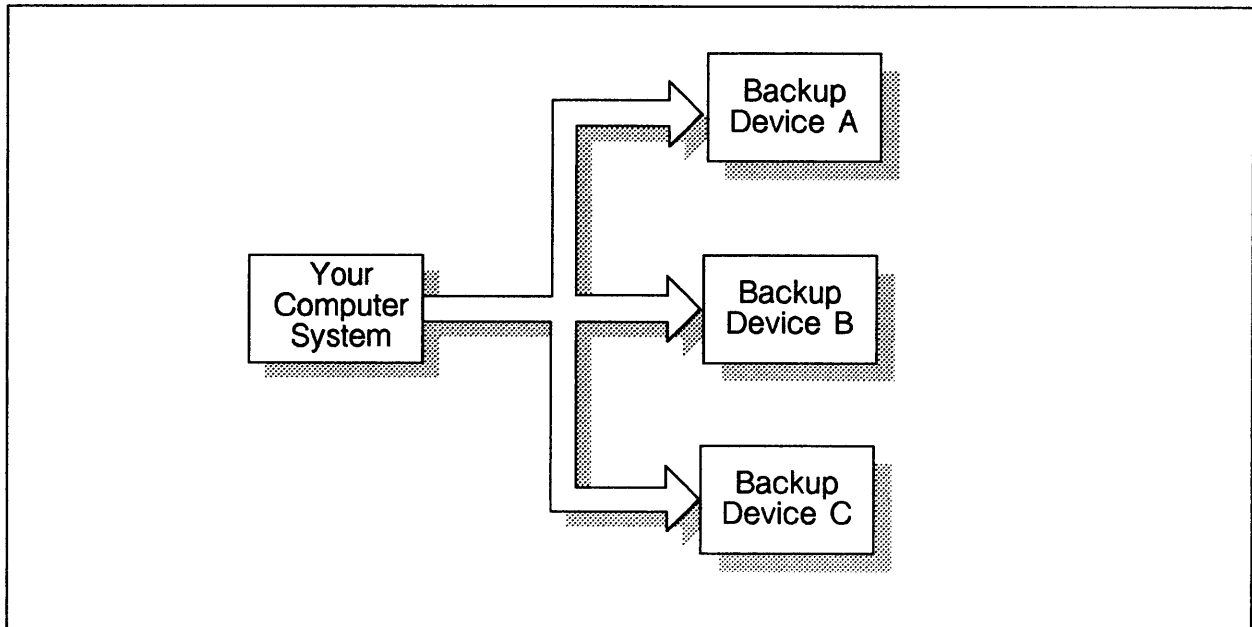

LG200021\_003

Figure 4-3. Parallel Device Backup.

## Parallel Device Pools

The most efficient way to use multiple backup devices is to combine sequential and parallel methods to copy files to parallel device pools at the same time as illustrated in Figure 4-4. Using parallel device pools gives you the advantages of both parallel and sequential devices. You copy file subsets at the same time, and always have another backup device ready when TurboSTORE fills the tape on any device. Figure 4-4 illustrates a parallel device pool backup. ■

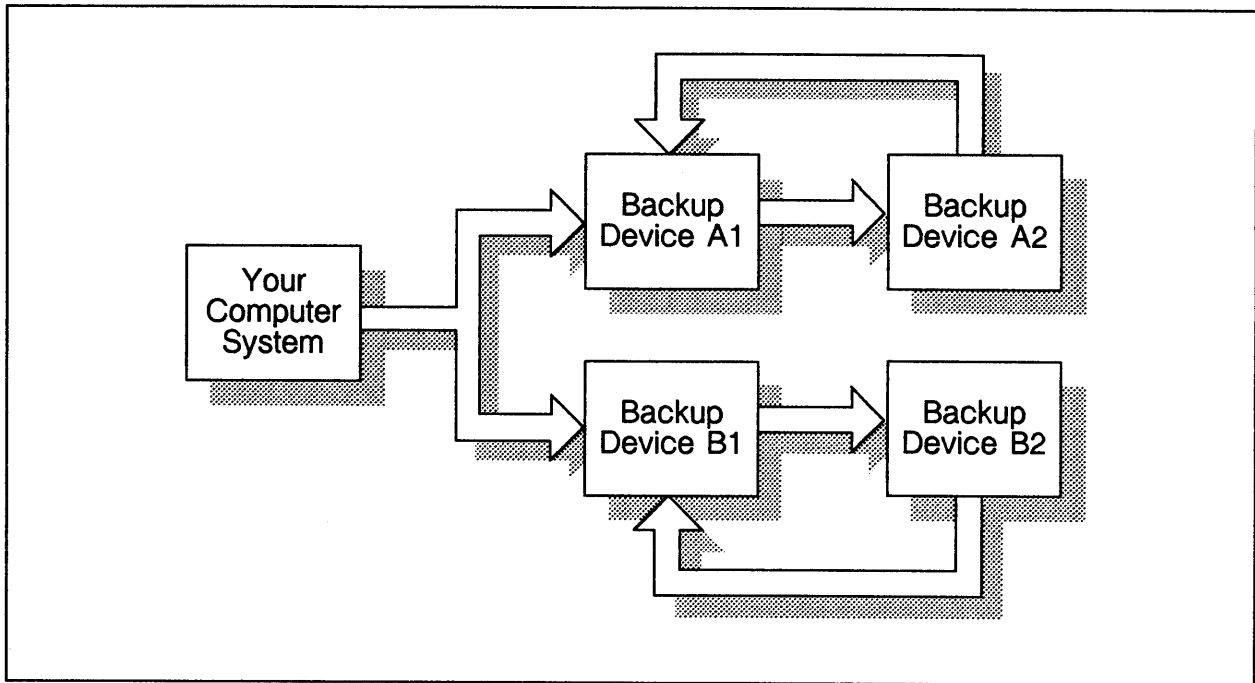

LG200021\_004

**Figure 4-4. Parallel Device Pool Backup.**

## Interleaved Format

Normally, standard STORE and TurboSTORE copy files to backup media in the order that you specify them in the :STORE command. When you store files in *interleaved* format, TurboSTORE partitions the files to be stored to your backup devices, and then may access several files at once and interleave the files on the same tape. File interleaving assures that your backup devices operate at full speed. In this way, interleaved format significantly reduces the time necessary to perform a backup.

Interleaved format is most efficient when your file set is evenly spread across two or more system discs. You might use interleaved format, for example, to perform full system backups when you have a large set of files to store. Use sequential devices or parallel devices alone to perform an incremental backup when the set of files to store is smaller and less evenly distributed. You can use interleaved format only with unlabeled tapes and with the TurboSTORE version of STORE.

Refer to Appendix C for more detailed information about interleaved tape format. Figure 4-5 illustrates interleaved tape format.

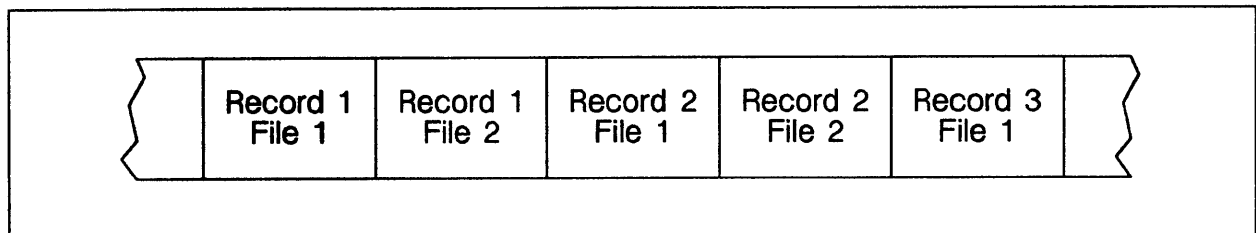

LG200021\_005

Figure 4-5. Interleaved Tape Format

---

### NOTE

If your backup tape is to be restored on an MPE XL system, do *not* use the interleaved format. It is not currently supported on MPE XL.

---

# Planning Multiple-Device Backups

Using multiple backup devices decreases the time you spend actually backing up your system, but requires you to spend more time planning your backups. It takes extra planning to select the best method for your system and to keep track of each device's position in the backup. You can only use multiple devices with TurboSTORE.

## Choosing a Method

In order to backup your system to more than one backup device, you must have several identical backup devices. Identical devices have the same:

- Device TYPE
- Device SUBTYPE
- Density
- Record size

The best way to use your backup devices depends upon your system configuration, the characteristics of the files that you are storing, and your needs for compatibility with other versions of MPE.

## File Set Characteristics

The more files there are in your backup set, the more it is to your advantage to use multiple devices to speed up your backups. You may have to experiment to find the best configuration for your system. In general, use as many devices as you can to perform full backups. You may find that incremental backups require fewer devices.

## Compatibility

If you are using standard STORE or an MPE version prior to G.03.00, you can use only one device. If you are using TurboSTORE and need to produce STORE tapes that are compatible with standard STORE or pre-G.03.00 MPE, you can backup files to either a single device or sequential devices. Refer to Table 4-1 on the following page.

**Table 4-1. STORE Compatibility Chart.**

STORE System	RESTORE System	
	Standard RESTORE	TurboRESTORE
Standard STORE	✓	✓
TurboSTORE with single or sequential devices	✓	✓
TurboSTORE with parallel devices or parallel device pools	⊘	✓

L.G200021\_032a

### Your System Configuration

If you aren't limited by your need for compatibility with standard STORE or pre-G.03.00 MPE, the most important determinant of which multiple-device method to use is your system configuration. Use the following guidelines to select a method:

1. Do you intend to use labeled tapes? You can use sequential devices, parallel devices, and parallel device pools only with unlabeled tapes.
2. Look up your system and its recommended configuration in Appendix E. If you do not find a recommended configuration that matches the devices that you have, continue to step 3.
3. What and how many backup devices do you have? In order to use sequential or parallel devices, you must have at least two identical backup devices. If you have two or three identical devices, use parallel or sequential devices. If you have four identical devices use two pools of two devices. You can have a maximum of four parallel or sequential devices. If you use parallel pools of sequential devices, you can use a maximum of 16 devices--four pools of four devices.

If your system configuration limits you to using a single device or if you are using sequential or parallel devices and want to make your backups even faster, you might want to consider adding backup devices and reconfiguring your system. System backups take up more time than any other routine Operator task. By reducing the time necessary to perform backups, you can increase the productivity of your System Operators and the availability of your system.

## Selecting Backup Devices

Once you've selected the type of multiple-device backup you want to perform, decide how to use your backup devices. Give each device a position in the backup according to its logical device (LDEV) number.

Figure 4-6 contains a chart for assigning your devices for a full backup. Select one of the backup methods in the chart, and then write in the LDEV numbers of each device you plan to use in the position that you plan to use it. For example, if you intend to perform a two-device parallel backup, write in the LDEV number of device A and the LDEV number of device B in the Parallel section. Using the chart helps you organize your backup. Figure 4-7 contains a similar chart for incremental backups. Photocopy these charts and use them as a guide during your backups.

<b>Full Backup</b>		Select either Sequential, Parallel, or Parallel Device Pools. Fill in LDEV numbers for each device you plan to use.	
<b>___ Sequential</b>			
Device 1 _____	Device 2 _____	Device 3 _____	Device 4 _____
<b>___ Parallel</b>			
Device A _____			
Device B _____			
Device C _____			
Device D _____			
<b>___ Parallel Device Pools</b>			
Device A1 _____	Device A2 _____	Device A3 _____	Device A4 _____
Device B1 _____	Device B2 _____	Device B3 _____	Device B4 _____
Device C1 _____	Device C2 _____	Device C3 _____	Device C4 _____
Device D1 _____	Device D2 _____	Device D3 _____	Device D4 _____

Figure 4-6. Full Backup Device Chart

## Incremental Backup

Select either Sequential, Parallel, or Parallel Device Pools.  
Fill in LDEV numbers for each device you plan to use.

### \_\_\_ Sequential

Device 1 \_\_\_\_\_ Device 2 \_\_\_\_\_ Device 3 \_\_\_\_\_ Device 4 \_\_\_\_\_

### \_\_\_ Parallel

Device A \_\_\_\_\_

Device B \_\_\_\_\_

Device C \_\_\_\_\_

Device D \_\_\_\_\_

### \_\_\_ Parallel Device Pools

Device A1 \_\_\_\_\_ Device A2 \_\_\_\_\_ Device A3 \_\_\_\_\_ Device A4 \_\_\_\_\_

Device B1 \_\_\_\_\_ Device B2 \_\_\_\_\_ Device B3 \_\_\_\_\_ Device B4 \_\_\_\_\_

Device C1 \_\_\_\_\_ Device C2 \_\_\_\_\_ Device C3 \_\_\_\_\_ Device C4 \_\_\_\_\_

Device D1 \_\_\_\_\_ Device D2 \_\_\_\_\_ Device D3 \_\_\_\_\_ Device D4 \_\_\_\_\_

Figure 4-7. Incremental Backup Device Chart

## Preparing Your Backup Media

In order to prepare your backup media for the backup, estimate the number of tapes you think the backup will require, label the tapes, and stack them near the appropriate backup device. Follow the specific instructions for the type of backup you intend to perform.

## Preparing for a Single-Device or a Sequential Backup

To prepare your backup media for a single-device (with standard or TurboSTORE) or sequential backup (with TurboSTORE only):

1. Estimate the number of blank tapes you need, and take them from your tape library.
2. Attach a label to each tape. A standard Hewlett-Packard tape label has several headings for different types of important information. If your tape label does not have such headings, you may want to create your own.
3. Label the first tape VOL 1 of N (replace N with the total number of tapes--if you use more or fewer tapes than you planned, you may have to change this number when the backup is complete). Label the second tape VOL 2 of N. Label the third tape VOL 3 of N, and so on.
4. In addition to the tape number, write the following information on each tape's label:
  - The date, under the CREATION DATE heading.
  - The name of your computer system, under the FILE ID heading.
  - Either FULL BACKUP or INCREMENTAL BACKUP, under the REMARKS heading
  - Any other important information about the tape, also under REMARKS. Since it is a store tape, write STORE. If you plan to use interleaved format, write interleaved on the label.
  - Your name or initials, under the INITIALS heading.
  - The date after which the information on the tape is obsolete, under the PURGE DATE heading. If you keep backup tapes indefinitely, make a note to that effect.
  - The number of times the tape has been used, under the CYCLE heading.



Figure 4-8 shows an example of a correctly labelled tape:

2/3/86		File ID	Systemname	Device No.
Creation Date	MYFILE.OPERATOR.SYS			
Effective Date	Job No.		Cycle	2
3/3/86	Remarks		STORE Tape	Volume 1 of 1
Purge Date				Initials
				JMK

LG200021\_022

Figure 4-8. Correctly Labelled Tape.

- If you plan to perform a single-device backup, stack all of your tapes label side up, in order with the lowest number on top, near the device as shown in Figure 4-9.

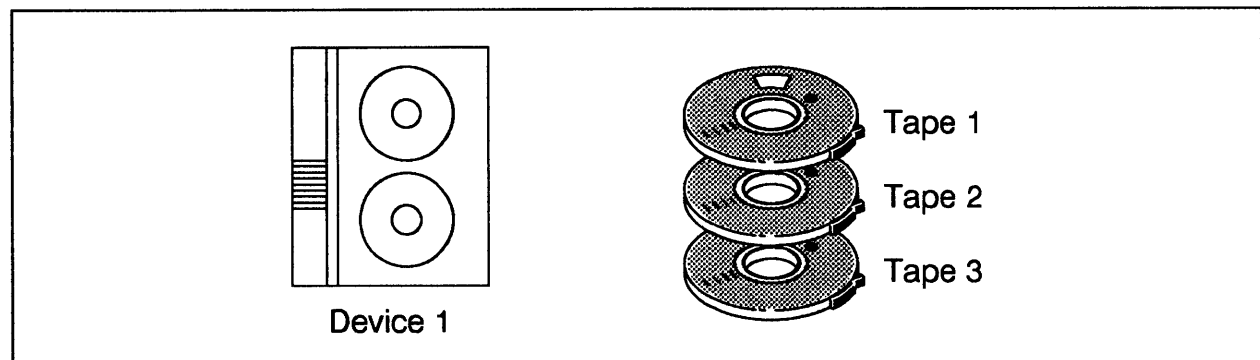

LG200021\_007

Figure 4-9. Preparing for Single Device Backup.

- If you plan to perform a sequential backup, divide your tapes among the devices in order. For example, if you have two sequential devices and six tapes, stack tapes 1, 3, and 5 near device 1 and stack tapes 2, 4, and 6 near device 2. Stack all tapes label side up and make sure that the lowest-numbered tape is on the top of each stack. Figure 4-10 shows an example.

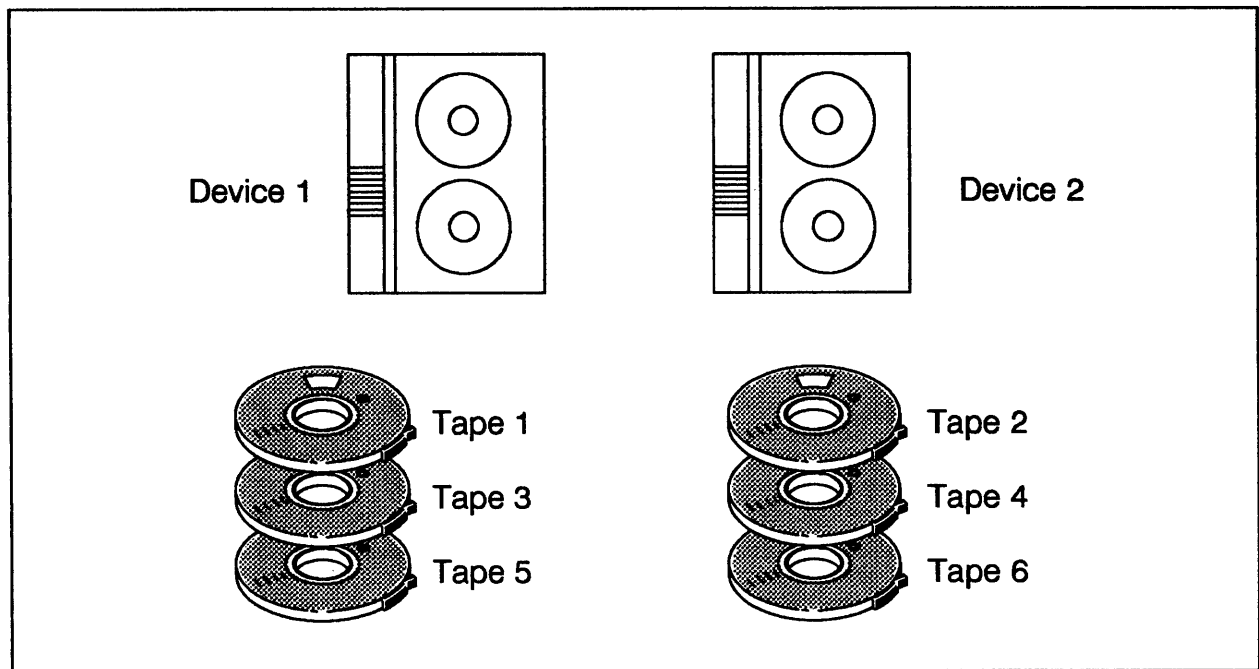

LG200021\_008

**Figure 4-10. Preparing Tapes for Sequential Devices.**

## Preparing Your Media for Parallel Devices and Parallel Device Pools

You can use parallel devices and parallel device pools only with the enhanced version of STORE. To prepare your backup media for a backup to parallel devices or parallel device pools:

1. Estimate the number of blank tapes you need, and take them from your tape library.
2. Attach a label to each tape. Standard Hewlett-Packard tape labels have headings for the different types of information that you should record. If your tape label does not have such headings, you may want to create them.
3. Label the first tape for the first device (or first device pool) VOL A1 OF X replacing X with the number of the last tape for each parallel device or device pool. (If you use more or fewer tapes than you planned, you may have to change these numbers when the backup is complete.) For example, if you plan to use four tapes and two parallel devices, label the first tape VOL A1 OF A2/B2. Label the second tape from the first device (or device pool) VOL A2 OF A2/B2. Label the first tape from the second device (or device pool) VOL B1 OF A2/B2, and label the second tape VOL B2 OF A2/B2.

4. In addition to the tape number, write the following information on each tape's label:
  - The date, under the CREATION DATE heading.
  - The name of your computer system, under the FILE ID heading.
  - Either FULL BACKUP or INCREMENTAL BACKUP, under the REMARKS heading.
  - Any other important information about the tape, also under REMARKS. Since it is a store tape, write STORE. If you plan to use interleaved format, write interleaved on the label.
  - Your name or initials, under the INITIALS heading.
  - The date after which the information on the tape is obsolete, under the PURGE DATE heading. If you keep backup tapes indefinitely, make a note to that effect.
  - The number of times the tape has been used, under the CYCLE heading.
5. If you are using parallel devices, stack all of your tapes, label side up, near the corresponding device, in order with the lowest number on top. For example, place all the tapes with numbers beginning with A near your first parallel device. Put tape A1 on top of the stack. Figure 4-11 shows how to prepare tapes for a parallel backup.

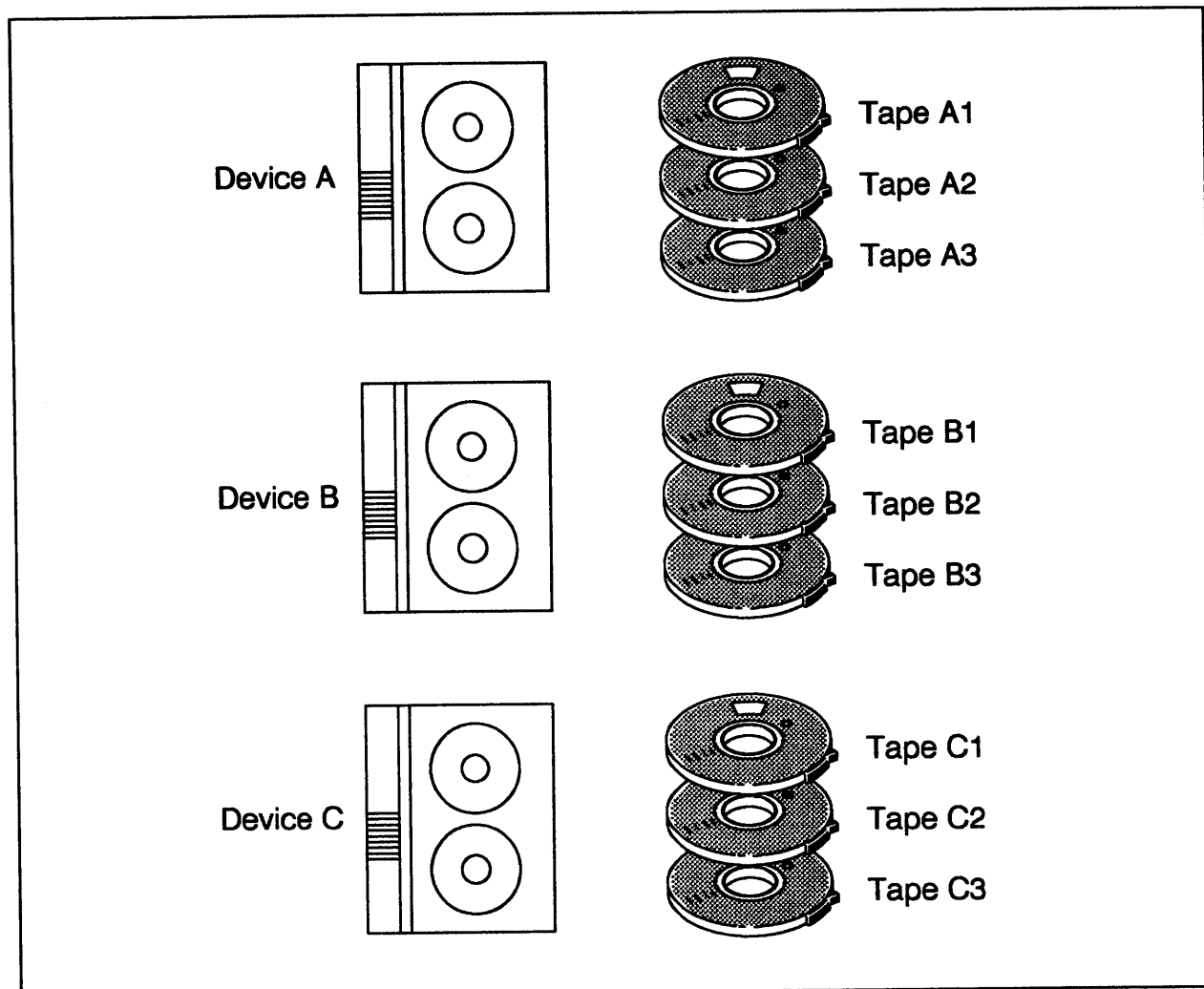

LG200021\_009

**Figure 4-11. Preparing Tapes for Parallel Devices**

6. If you are using parallel device pools, divide your tapes among the devices in each device pool in order. For example, if the first device pool has two sequential devices and four tapes, stack tapes A1 and A3 near device 1, and stack tapes A2 and A4 near the second device. Figure 4-12 shows tapes prepared for a sample backup to parallel device pools.

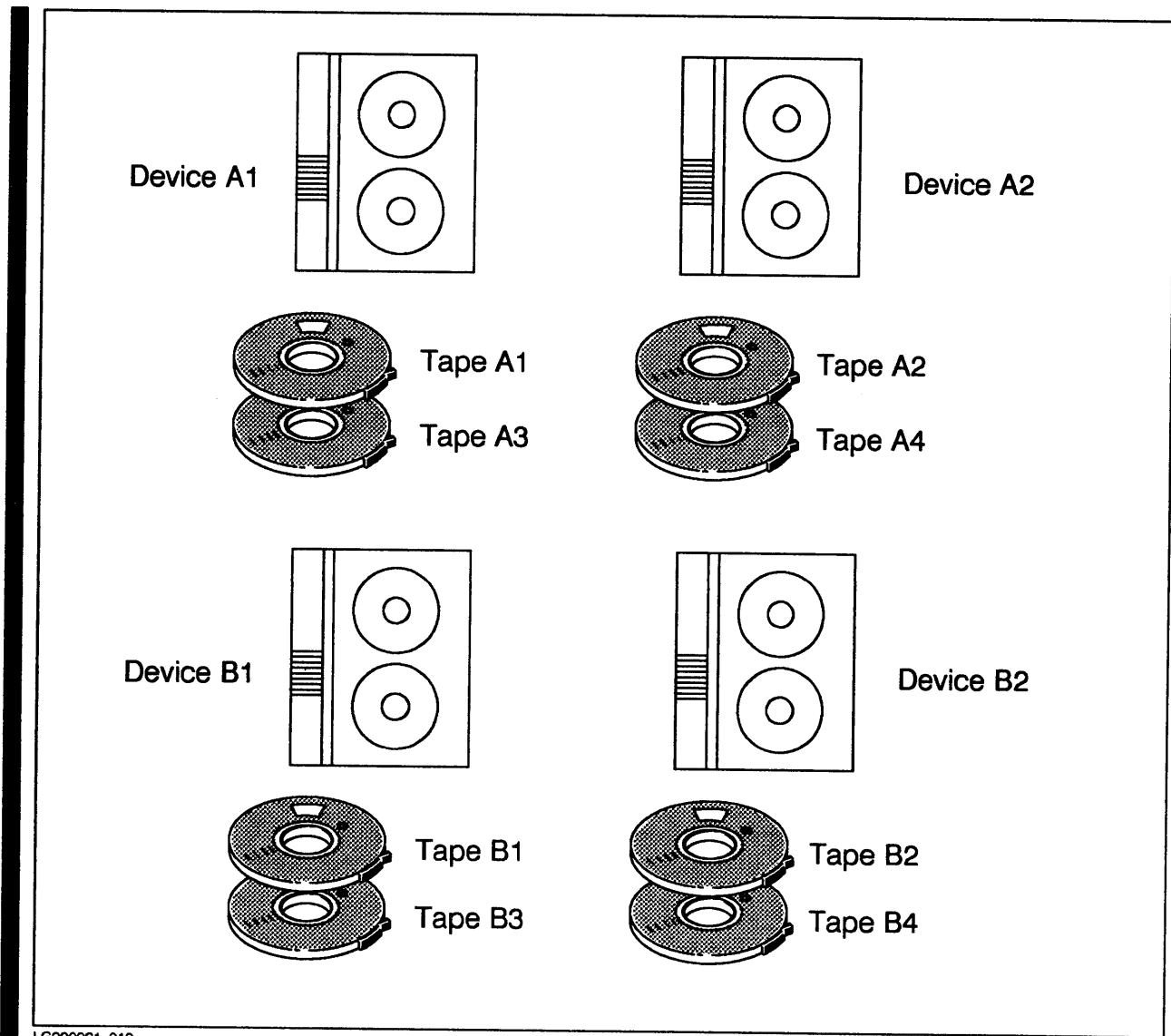

LG200021\_010

**Figure 4-12. Preparing Tapes for Parallel Device Pools**

# Preparing Backup Devices

Prepare your backup devices by mounting the first tape in the stack near each device onto that device. Follow the instructions for mounting backup media in Appendix F.

## Storing Files

You use two commands to store files to the mounted backup media. First, a `:FILE` command or a series of `:FILE` commands give your backup devices file names. Second, a `:STORE` command describes the files you want to store, the devices to which to store them (using the names you assigned), and the options you want to use.

## Issuing FILE Commands

A `:FILE` command for a backup assigns a file name to a backup device by its LDEV number or by its device class. For example, the following `:FILE` command assigns the name T to the device with LDEV number 8:

```
:FILE T; DEV=8
```

The following `:FILE` command assigns the name BACKUP to the device with the device class name TAPE.

```
:FILE BACKUP; DEV=TAPE
```

Using the backup device's logical device number is a more exact way to assign a name to a particular device. There is only one device with LDEV number 8 in your system; however, several devices may be assigned the device class TAPE. When you use device classes to name backup devices, `STORE` asks you to assign a logical device to the file name with a tape request. Refer to "Responding to Tape Requests."

Your `:FILE` commands are especially important when you are using multiple backup devices and when your system is configured to automatically assign devices. Refer to Appendix F for a description of automatically assigned devices.

## FILE Commands for Automatically Assigned Devices

In order to have devices automatically assigned to the backup, you must use LDEV numbers or unique device classes in your `:FILE` commands. An LDEV number or unique device class tells the system exactly which device you intend to use. Refer to Appendix F for a description of automatically assigned devices.

## File Commands for Multiple Backup Devices

To backup files to multiple backup devices, either give each device a unique file name, or assign a single name to the devices' common device class. Assigning each device a unique name, the recommended method, makes it easy for you to keep track of each device's position in the backup. When you receive tape requests or mount requests,

you know exactly to which device the request applies. You can give devices unique names based on their LDEV numbers or their device classes. When you use device classes to name backup devices, STORE asks you to assign a logical device to the file name with a tape request. (Refer to "Responding to Tape Requests".)

Assign names based on each device's position in the backup. For example, if you plan to use four parallel devices, you might issue the following set of :FILE commands:

```
:FILE PARA; DEV=TAPE
:FILE PARB; DEV=TAPE
:FILE PARC; DEV=TAPE
:FILE PARD; DEV=TAPE
```

Name sequential devices in order. For example, if you are using two sequential devices, you might issue the following :FILE commands:

```
:FILE SEQ1; DEV=LDEV8
:FILE SEQ2; DEV=LDEV9
```

Name devices from parallel device pools so that you know their position in the backup. For example:

```
:FILE PADEV1; DEV=TAPE
:FILE PADEV2; DEV=TAPE
:FILE PBDEV1; DEV=TAPE
:FILE PBDEV2; DEV=TAPE
```

Assigning a common file name to all of your backup devices lets you issue a single :FILE command. For example:

```
:FILE T; DEV=TAPE
```

You use the common name, T in the example above, to refer to each device in your :STORE command. In a tape request, the system asks you to assign a LDEV number to the common name for each device. If you have four backup devices, you see four identical tape requests. You assign a different LDEV number to each file based upon the order in which you receive the tape requests. Refer to "Responding to Tape Requests" for more information.

## Backing Up Files with ACDs

New security features available with MPE V/E allow file access to be made more secure. This is accomplished through the use of Access Control Definitions (ACDs). An ACD contains a list of users and the types of access each user has to a device or file. The access types are: R: READ; W: WRITE; L: LOCK; A: APPEND; X: EXECUTE; NONE: no access; RACD: READ (LIST) ACD).

An ACD is “owned” by the creator of the file, any user with Account Manager (AM) capability in the account where the file resides, or any user with System Manager (SM) capability. In order to store a file that has an ACD, a user must be an owner or have RACD permission.

You, as the System Operator, are not affected by ACDs (in this instance, OP capability is considered to be the same as SM). When you backup files using a STORE command, all files, whether or not they have ACDs, will be stored.

## Security Considerations

Files can be stored with or without their associated ACDs. However, if files are stored without their ACDs, access control will be lost. Therefore, if file security is important, ACDs should be stored with their files. To do this, add the COPYACD parameter to the :STORE command.

```
:STORE MYFILE.OPERATOR.SYS;*T;COPYACD
```

## Compatibility Considerations

When the COPYACD parameter is used, even if no file has an ACD, the backup tape can only be used on MPE V/E systems. Pre-MPE V/E systems will not recognize the tape. Current MPE XL systems will also reject it, since ACDs are not supported on them as yet. Therefore, if the tapes are likely to be used on pre-MPE V/E or MPE XL systems, do not use COPYACD.

For more information on ACDs, see the *MPE V/E Security and Account Structure Manual* (32033-90136).



## Backing Up Files to a Single Device

If you are using the standard version of STORE, you can only back up files to one device.

### Full Backup

To perform a full backup to a single device:

1. First describe your backup device with a `:FILE` command, for example:

```
:FILE T; DEV=TAPE
```

or

```
:FILE T; DEV=8
```

2. Enter the following `:STORE` command:

```
:STORE @ . PUB . SYS , @ @ @ - @ . PUB . SYS , *T , COPYACD , SHOW-OFFLINE , PROGRESS
```

The `:STORE` command first copies all system and user files, prints a list of files stored on the system printer, and notifies you of its progress every minute.

### Incremental Backup

To perform an incremental backup to a single device:

1. Define your backup device with a `:FILE` command. For example:

```
:FILE T; DEV=TAPE
```

or

```
:FILE T; DEV=8
```

2. Enter the following `:STORE` command, substituting the date of the last full backup for `mm/dd/yy`:

```
:STORE @ . PUB . SYS , @ @ @ - @ . PUB . SYS , *T , COPYACD , SHOW-OFFLINE , &  
:DATE> -MM/DD/YY; PROGRESS
```

The `:STORE` command first copies all system and user files modified since the date of the last full backup, prints a list of files stored on the system printer, and informs you of its progress every minute.

## Backing Up Files to Sequential Devices

You can back up files to sequential devices only with the TurboSTORE.

### Full Backup

To perform a full backup to sequential devices:

1. Describe your backup devices with :FILE commands. For example, the following :FILE commands describe two sequential devices:

```
:FILE SEQ1; DEV=TAPE  
:FILE SEQ2; DEV=TAPE
```

2. Enter the following :STORE command:

```
:STORE @ PUB SYS @ @ @ @ PUB SYS,COPYACD;SHOW-OFFLINE;PROGRESS; &  
STORESET=(*SEQ1,*SEQ2)
```

The :STORE command first copies all system and then user files, it prints a list of files on the system printer, and notifies you of its progress every minute.

The STORESET parameter (available only with the enhanced version of STORE) describes multiple backup devices. Parentheses group devices into a device pool. If your device pool contains more devices, include them in your :FILE and :STORE commands.

### Incremental Backup

To perform an incremental backup to sequential devices:

1. Define your backup devices with a :FILE command. For example:

```
:FILE SEQ1; DEV=TAPE  
:FILE SEQ2; DEV=TAPE
```

2. Enter the following :STORE command, substituting the date of the last full backup for mm/dd/yy and naming your backup devices with the STORESET parameter:

```
:STORE @ PUB SYS @ @ @ @ PUB SYS;SHOW-OFFLINE;DATE>=mm/dd/yy; &  
PROGRESS;STORESET=(*SEQ1,*SEQ2)
```

The :STORE command first copies all system and then user files modified since the date of the last full backup, it prints a list of files stored on the system printer, and informs you of its progress every minute.

## Backing Up Files to Parallel Devices

You can only use parallel devices with TurboSTORE.

### Full Backup

To perform a full backup to parallel devices:

1. Describe your backup devices with `:FILE` commands. Either assign a unique name to each device, or assign the devices a common name. For example, the following commands name four parallel devices:

```
:FILE PARA; DEV=TAPE
:FILE PARB; DEV=TAPE
:FILE PARC; DEV=TAPE
:FILE PARD; DEV=TAPE
```

2. Enter a `:STORE` command that backreferences the backup device names within the `STORESET` parameter:

```
:STORE @.PUB.SYS,@.@.@.PUB.SYS,COPYACD,SHOW-OFFLINE,PROGRESS &
STORESET=(*PARA),(*PARB),(*PARC),(*PARD)
```

The `:STORE` command above first copies all system and then user files, lists the files on the system printer, and reports the progress of the backup every minute.

### Incremental Backup

To perform an incremental backup to parallel devices:

1. Describe your backup devices with `:FILE` commands. For example, the following `:FILE` commands describe two parallel devices:

```
:FILE PARA;DEV=TAPE
:FILE PARB;DEV=TAPE
```

2. Enter the following `:STORE` command, substituting the date of the last full backup for `mm/dd/yy` and naming your backup devices with the `STORESET` parameter:

```
:STORE @.PUB.SYS,@.@.@.PUB.SYS;SHOW-OFFLINE; &
DATE=>mm/dd/yy;PROGRESS;STORESET=(*PARA),(*PARB)
```

## Backing up Files to Parallel Device Pools

You can only back up files to parallel device pools with TurboSTORE.

### Full Backup

To perform a full backup to parallel device pools:

1. Describe your backup devices with `:FILE` commands. Either assign a unique name to each device, or assign the devices a common name. For example, the following commands name two parallel device pools:

```
:FILE PADEV1; DEV=TAPE
:FILE PADEV2; DEV=TAPE
:FILE PBDEV1; DEV=TAPE
:FILE PBDEV2; DEV=TAPE
```

2. Name the devices, in order, within the `STORESET` parameter of the `:STORE` command. For example:

```
:STORE @.PUB.SYS @. @. @. @. PUB.SYS; COPYACD; SHOW=OFFLINE; PROGRESS: &
STORESET=(*PADEV1, *PADEV2), (*PBDEV1, *PBDEV2)
```

In the `:STORE` commands above, parentheses group devices into device pools, and commas separate parallel device pools. The command first copies all system and then user files, lists the files on the system printer, and reports the progress of the backup every minute.

### Incremental Backup

To perform an incremental backup to parallel device pools:

1. Describe your backup devices with `:FILE` commands. For example, the following `:FILE` commands describe two parallel devicepools:

```
:FILE PADEV1; DEV=TAPE
:FILE PADEV2; DEV=TAPE
:FILE PBDEV1; DEV=TAPE
:FILE PBDEV2; DEV=TAPE
```

2. Enter the following `:STORE` command, substituting the date of the last full backup for `mm/dd/yy` and naming your backup devices with the `STORESET` parameter:

```
:STORE @.PUB.SYS @. @. @. @. PUB.SYS; SHOW=OFFLINE; DATE=--mm/dd/yy; &
PROGRESS; STORESET=(*PADEV1, *PADEV2), (*PBDEV1, *PBDEV2)
```

## Backing Up Files in Interleaved Format

If you are using TurboSTORE, you can back up files in interleaved format. You can use interleaved format with single, sequential, parallel devices, or parallel device pools. To back up files in interleaved format, include the INTER parameter in your :STORE command. For example:

```
:FILE PARA; DEV=TAPE
:FILE PARB: DEV=TAPE
STORE @ PUB.SYS @ @ @ @ PUB.SYS COPYACD; SHOW-OFFLINE PROGRESS; &
STORESET=(*PARA),(*PARB); INTER
```

Refer to Appendix C for more detailed information about interleaved tape format.

## Monitoring Your Progress

As the backup progresses, you see several messages on the Console. Some require you to act and respond, and others notify you of the backup's progress. The messages fall into four categories:

- Tape requests.
- NO WRITE RING messages.
- Mount requests.
- Progress messages.

This section describes each type of message and the actions to perform when you see a message.

## Responding to a Tape Request

When your backup devices are not configured to be automatically assigned, the system answers your :STORE command with one or more tape requests. For example:

```
?14:57/#S25/43/LDEV# FOR "SEQ1" on TAPE (NUM)?
```

The tape request asks you to assign a LDEV number to the file named in the request. The request above asks you to assign a logical device to the file SEQ1.

## Using the REPLY Command

You *reply* to a tape request to assign a logical device to the named file. You must reply to the tape request before the backup can begin. In order to reply to a tape request, you must know:

- The STORE Process Identification Number (PIN). The PIN follows the second slash (/) in the tape request. The PIN is 43 in the preceding example.

- The logical device number (LDEV) of the backup device. You should have logical device numbers listed in your Backup Device Chart; if not, the LDEV number appears in the TAPE MOUNTED message you receive at the console after bringing a tape drive online.

To answer a tape request, use the `:REPLY` command to assign a logical device to the STORE PIN. For example, to assign the tape drive with logical device number 8 to the STORE process with the PIN 43, enter:

```
:REPLY 43 8
```

Refer to Appendix F for more detailed instructions for answering tape requests.

### Replying To Tape Requests for a Multiple-Device Backup

If you are backing up files to several devices, the system sends you a tape request for each device. You receive tape requests in the order that you listed the file names in the STORESET parameter. Use your Backup Device Chart to determine which LDEV to assign to each name.

### Responding to a NO WRITE RING Message

Reel-to-reel tapes require you to insert a *write ring* into the reel in order to copy files to the tape. Refer to Appendix F. If you did not insert a write ring into a tape reel before mounting it, you see the following message:

```
14:57/2/LDEV#nn NO WRITE RING
```

Without a write ring, the tape is protected. Before the backup can begin, you must unload the tape, insert the ring, and reload the tape:

1. Unload the tape. Follow the instructions in Appendix F.
2. Insert a write ring into the circular groove on the back of the reel.
3. Mount the tape. Refer to Appendix F for instructions. The backup begins automatically; you do not need to re-issue the `:STORE` command.

### Progress Messages

If you've used the PROGRESS parameter in your `:STORE` command, the system displays progress messages at the interval you specified (or every minute if you didn't include a progress interval in your command). For example:

```
STORE OPERATION IS 4% COMPLETE
```

You see similar messages at regular intervals, for example:

```
STORE OPERATION IS 7% COMPLETE  
STORE OPERATION IS 11% COMPLETE  
STORE OPERATION IS 14% COMPLETE
```

## Mounting Additional Tapes

When STORE fills the tape on a device and it has additional information to store to that device, it asks you to mount another tape. You see a mount request and LDEV NOT READY message like the following ones:

```
15:28/#S43/59/STORE: Please mount reel 4 on LDEV8 if not already mounted  
(S/R 9024)  
15:29/S#43/59 LDEV #8 NOT READY
```

The mount request above asks you to mount another tape on logical device 8. If you leave the Console while performing a backup, other messages that you receive can cause mount requests to scroll off the Console screen. Use the `:RECALL` command to display such mount requests. For example:

```
:RECALL  
15:28/#S43/59/STORE: Please mount reel 4 on LDEV8 if not already mounted
```

To mount another tape on the device named in the mount request:

1. Unload the full tape. (Refer to Appendix C for instructions.) Place it face down on the stack of written tapes and remove the write ring.
2. Select the next tape from the stack near the backup device. If there are no more tapes in the stack, prepare a new tape following the instructions in "Preparing your Backup Media."
3. Mount the new tape. Refer to Appendix F for instructions.
4. Continue monitoring the backup process. Mount new tapes as the system requests them.

## Once the Backup is Complete

Once the backup is complete, retrieve your listing from the printer and return your system to its normal state. Follow the instructions in Chapter 3.

## Performing a Backup Using SYSDUMP

---

When you use the STORE program to back up user files, you must create a cold load tape to back up your system configuration and system files. You use the SYSDUMP program to create a cold load tape. You can also use SYSDUMP to perform regular full and incremental backups of your system configuration, system files, and user files. However SYSDUMP *does not* support the faster methods for backing up user files available with the enhanced STORE program (available as a separate product in G.03.00 and later versions of MPE).

The SYSDUMP program lets you alter your system configuration as well as back up your system. Because it is so powerful, SYSDUMP requires System Supervisor (OP) capability.

Your response to the SYSDUMP dialog determines what SYSDUMP stores to your backup media. This section describes procedures for using SYSDUMP to create cold load and complete backup tapes. Refer to Section 7 of the *MPE V System Operation and Resource Management Manual* (32033-90005) for a step-by-step description of the SYSDUMP dialog.

### Preparing to Use SYSDUMP

Before you begin the SYSDUMP program, issue one or two :FILE commands. The first tells MPE where to send the output of the SYSDUMP program. For example:

```
:FILE T;DEV=TAPE
```

The other directs the listing generated by the SYSDUMP program to a printer instead of the default, a terminal. For example:

```
:FILE L;DEV=LP
```

You name the two files, in order, in your :SYSDUMP command. Precede the file names with an asterisk (\*) to backreference the :FILE commands. For example:

```
:SYSDUMP *T,*L
```



## Creating a Coldload Tape

When you perform system backups with the STORE program, you must create a cold load tape to complement your backup tapes. A coldload tape contains your system configuration and system files. Should you need to reload your system from backup tapes, you use the cold load tape to start up and configure the system and then use the most recent STORE tapes to reload user files.

To create a cold load tape:

1. Mount a tape on your backup device. Refer to Appendix C for instructions.
2. Prepare your system for performing a backup following the instructions in Chapter 3.
3. Run the SYSDUMP program and respond to its questions as shown in the following example.

```
:FILE T; DEV=TAPE
:FILE L; DEV=LP
:SYSDUMP *T,*L
```

```
ANY CHANGES? 
```

```
ENTER DUMPDATE? 0
```

```
ENTER DUMP FILE SUBSET(S) @.PUB.SYS;COPYACD
```

The COPYACD parameter is needed in case there are any files with ACDs. Refer to Chapter 4 for a brief discussion of ACDs.

```
LIST FILES DUMPED? YES
```

```
END OF SUBSYSTEM
```

4. When the process is complete, remove the tape from the backup device and label it, retrieve the listing from the printer, and store both with your other backup tapes.
5. Allow users to access the system once again following the instructions in Chapter 3.

## Performing a Full Backup

A full SYSDUMP backup copies the system configuration, system files, file system directory, and user files to tape. Unlike TurboSTORE, SYSDUMP copies files to only one backup device.

To perform a full backup with SYSDUMP:

1. Prepare a tape and mount it on your backup device. Refer to Appendix F for instructions.
2. Prepare the system for performing a backup following the instructions in Chapter 3.
3. Run the SYSDUMP program and respond to its questions as shown in the following example.

```
:FILE T: DEV=TAPE
:FILE L: DEV=LP
:SYSDUMP *T,*L
```

```
ANY CHANGES? N
ENTER DUMPDATE? 0
ENTER DUMP FILE SUBSET(S) @.@.@.COPYACD
```

The COPYACD parameter is needed to copy the ACDs associated with any files. Refer to Chapter 4 for a brief discussion of ACDs.

```
LIST FILES DUMPED? YES
END OF SUBSYSTEM
```

4. Monitor your progress. If you see a request to mount another tape, unload the first tape, label it and store it, and then mount another tape.
5. When the backup is complete, unload the last tape, label it, and store it in your tape library with the other tapes from the backup. Allow users access to the system again following the instructions in Chapter 3.

You can also use the :FULLBACKUP command to perform a full SYSDUMP backup. To use the :FULLBACKUP command, type the following set of commands:

```
:FILE T: DEV=TAPE
:FILE L: DEV=LP
:FULLBACKUP *T,*L
```

---

## NOTE

The `:FULLBACKUP` command does not interface with TurboSTORE functionality. Keep in mind that you must use the `:STORE` and `:SYSDUMP` commands to execute a full backup and take advantage of TurboSTORE functionality. See Chapter 6 for instructions.

---

### Performing an Incremental Backup

An incremental SYSDUMP backup copies your system configuration and all files that were modified since the last full backup.

1. Prepare your backup media and mount it on your backup device. Refer to Appendix F for instructions.
2. Prepare your system for performing a backup following the instructions in Chapter 3.
3. Run the SYSDUMP program and respond to its questions as shown in the following example.

```
:FILE T; DEV=TAPE
:FILE L; DEV=LP
:SYSDUMP *T,*L
```

ANY CHANGES? N

ENTER DUMPDATE?

ENTER DUMP FILE SUBSET(S) @.@.@; COPYACD

LIST FILES DUMPED? YES

END OF SUBSYSTEM

4. Monitor your progress. If you see a request to mount another tape, unload the first tape, label and store it, and then mount another tape.
5. When the backup is complete, unload all tapes, check that they are labeled, and store them in a safe place. Allow users access to the system again following the instructions in Chapter 3.

You can also use the `:PARTBACKUP` command to perform an incremental SYSDUMP backup. To use the `:PARTBACKUP` command, type the following set of commands:

```
:FILE T; DEV=TAPE
:FILE L; DEV=LP
:PARTBACKUP *T,*L
```

---

## NOTE

The `:PARTBACKUP` command does not interface with TurboSTORE functionality. Keep in mind that you must use the `:STORE` and `:SYSDUMP` commands to execute an incremental backup and take advantage of TurboSTORE functionality. See Chapter 6 for instructions.

---

## Other Uses of SYSDUMP

In addition to using the SYSDUMP program to create cold load tapes and to perform regular system backups, you can use it to store various components of MPE.

### Performing a Carriage Return SYSDUMP

A Carriage Return SYSDUMP creates a duplicate of MPE, your current I/O configuration, and your current system parameters. It contains no files, directory, or accounting structure. It is called a "Carriage Return" SYSDUMP, because you answer the SYSDUMP questions with a carriage return (). You might use the tapes you create during a Carriage Return SYSDUMP to load configuration changes and new parameter settings onto your system during a COLDDLOAD. (Refer to *System Operation and Resource Management* (32033-90005) for more information.) To perform a Carriage Return SYSDUMP, enter the following:

```
: FILE T: DEV=TAPE  
: FILE L: DEV=LP  
: SYSDUMP *T, *L
```

ANY CHANGES?

ENTER DUMPDATE?

END OF SUBSYSTEM

### Performing a Future Date SYSDUMP

A Future Date SYSDUMP copies MPE, the current system configuration, the directory, and the accounting structure. It is called a "Future Date" SYSDUMP, because you enter a date in the future to prevent the system from storing user files. Use the tapes you create during a Future Date SYSDUMP, for example, to transfer your system's configuration to another system.

To perform a Future Date SYSDUMP, enter the following commands:

```
: FILE T: DEV=TAPE  
: FILE L: DEV=LP  
: SYSDUMP *T, *L
```

ANY CHANGES? N

ENTER DUMPDATE? 12/31/99

ENTER DUMP FILE SUBSET (S)

LIST FILES DUMPED?

END OF SUBSYSTEM

## **Performing a SYSDUMP Programmatically**

You can use the `CREATEPROCESS` intrinsic to perform a `SYSDUMP` backup from within a program. Use `FULLBKUP` or `PARTBKUP` as the entry point to the `SYSDUMP` program. Refer to the *MPE V Ininsics Reference Manual (32033-90007)* for a complete description of the `CREATEPROCESS` intrinsic. You must have Process Handling (PH) capability.

# Performing a Backup Using TurboSTORE

---

This chapter describes how to perform a backup using TurboSTORE. You must first use the SYSDUMP program to back up system configuration files, then use TurboSTORE to back up user files. Instructions are provided here for doing both a full and an incremental backup using parallel devices.

## Backing Up to Parallel Devices

Backups to parallel devices can only be performed with TurboSTORE. For instructions on how to perform backups on other types of device configurations, refer to Chapter 4.

### Full Backup

Here is an example of how to perform a full backup to parallel devices using SYSDUMP and TurboSTORE. You must modify your commands to reflect your particular configuration.

1. Prepare to back up your system configuration using SYSDUMP by doing the following:
  - i) Prepare a tape and mount it on your backup device. Refer to Appendix C for instructions.
  - ii) Prepare the system for performing a backup by following the instructions in Chapter 3.
2. Save your system configuration with SYSDUMP. SYSDUMP only allows you to use one tape drive. First issue the following :FILE commands to redirect the output of the SYSDUMP program:

```
:FILE T,DEV-TAPE  
:FILE L,DEV-LP
```

- Run the SYSDUMP program and respond to its questions as shown in the following example:

```

:SYSDUMP *T, *L
ANY CHANGES? N
ENTER DUMP DATE 0
ENTER DUMP FILE SUBSETS? @.PUB.SYS;COPYACD
The COPYACD parameter is needed to copy the ACDs associated with any files.
See Chapter 4 for a brief discussion of ACDs.
LIST FILE DUMPED? YES
END OF SUBSYSTEM

```

The @.PUB.SYS response displayed above causes the PUB.SYS files to be stored.

- Monitor your progress. If you see a request to mount another tape, unload the first tape, label it, and then mount another.
- You are now ready to back up user files with TurboSTORE. Describe your backup devices with :FILE commands. Either assign a unique name to each device, or assign the devices a common name. For example, the following commands name four parallel devices:

```

:FILE PARA; DEV-TAPE
:FILE PARB; DEV-TAPE
:FILE PARC; DEV-TAPE
:FILE PARD; DEV-TAPE

```

- The example below backreferences the parallel backup device names within the STORESET parameter.

```

:STORE @.e.e.e.e.PUB.SYS;SHOW-OFFLINE;PROGRESS;6
STORESET=(*PARA),(*PARB),(*PARC),(*PARD)

```

- The :STORE command above copies all user files, lists the files on the system printer, and reports the progress of the backup every minute.
- When the backup is complete, unload the last tape, label it, and store it in your tape library. Allow users access to the system again by following the instructions in Chapter 3.



## Incremental Backup

Here is an example of how to perform an incremental backup to parallel devices using SYSDUMP and TurboSTORE. You must modify your commands to reflect your particular configuration.

1. Prepare to back up your system configuration with the SYSDUMP command by doing the following:
  - i) Prepare a tape and mount it on your backup device. Refer to Appendix C for instructions.
  - ii) Prepare the system for performing a backup by following the instructions in Chapter 3.
2. Save your system configuration with SYSDUMP. SYSDUMP only allows you to use one tape drive. First issue the following :FILE commands to redirect the output of SYSDUMP:

```
:FILE T:DEV=TAPE  
:FILE L:DEV=LP
```

3. Run the SYSDUMP program and respond to its questions as shown in the following example:

```
:SYSDUMP *T,*L  
ANY CHANGES? N  
ENTER DUMP DATE mm/dd/yy  
ENTER DUMP FILE SUBSETS? @.PUB.SYS;COPYACD  
LIST FILE DUMPED? YES  
END OF SUBSYSTEM
```

The @.PUB.SYS response displayed above causes the PUB.SYS files to be backed up.

You may respond to the “ENTER DUMP DATE” prompt in one of two ways:

- i) Enter the date of the last full backup. This will give you a large backup tape set that includes everything since the last full backup. This method is advantageous in the sense that when you do your tape recovery, you will only need to use the most recent incremental tape set, plus the most recent full backup tape set.
- ii) Enter the date of the last incremental backup. This will produce a smaller tape set, but when you do your tape recovery, you will have to use all of the incremental tape sets since the last full backup, plus the full backup tape set.

---

## NOTE

If SYSDUMP is part of a jobstream, make sure that you modify that jobstream to reflect the correct dump date each time the jobstream is run.

---

4. Monitor your progress. If you see a request to mount another tape, unload the first tape, label and store it, and then mount another.
5. Describe your backup devices with `:FILE` commands. Either assign a unique name to each device, or assign the devices a common name. For example, the following commands name two parallel devices:

```
:FILE PARA: DEV=TAPE  
:FILE PARB: DEV=TAPE
```

6. Enter the following `:STORE` command, substituting the date of the last backup (See #3 for options), and naming your backup devices with the `STORESET` parameter.

```
:STORE @@@@ PUB SYS:SHOW-OFFLINE: &  
DATE=@mm/dd/yy:PROGRESS:STORESET=(*PARA).(*PARB)
```

- The `:STORE` command above stores all user files, lists the files on the system printer, specifies the date of the last backup, and reports the progress of the backup every minute.
7. When the backup is complete, unload the last tape, label it, and store it in your tape library. Allow users access to the system again by following the instructions in Chapter 3.

# Using Backup Media To Recover From a System Failure

---

In the event of a major system failure, you may need to reload your system from backup media. Regardless of which method used to back up the system, your backup tapes contain three important types of information:

- System configuration
- System files
- User files

Depending upon the nature of the system failure, you might need to reload any one of these components or all of them. If you use STORE to perform regular system backups, you can restore system configuration and system files from the backup coldload tape, and user files from the backup STORE tapes. If you use SYSDUMP to perform regular system backups, you can restore all of the components from your SYSDUMP backup tapes. Always consult your System Manager before restoring system information from backup media.

## Reloading Files from STORE Backups

To completely reload your system from backup media when using STORE to perform regular system backups:

1. Reload your system configuration and system files from your backup cold load tape using the RELOAD option of the INITIAL program. Refer to Section VII, “System Configuration/Startup”, in the *System Operation and Resource Management Reference Manual* (32033-90005) for instructions.
2. Once the system is running, use the RESTORE program to restore user files from your most recent backup tapes to disc.
3. If your most recent backup tapes are from an incremental backup, use RESTORE to restore files from your most recent full backup tapes to disc, keeping the files you have already restored from the incremental backup by using the KEEP option.

This chapter describes each of these steps.

## Reloading your System Configuration and System Files

Refer to the *System Operation and Resource Management Reference Manual* (32033-90005) for instructions for reloading your system configuration and system files from your cold load tape.

## Restoring User Files From Backup STORE Tapes

Use the RESTORE program to restore user files from your backup STORE tapes to disc. Like STORE, RESTORE has two versions: standard RESTORE and TurboRESTORE. Standard RESTORE is part of the MPE fundamental operating software. TurboRESTORE is a separate product.

With the standard version of RESTORE, you can restore files from only one backup device. When you use TurboRESTORE, you can choose to restore files from a single device, a set of sequential devices, a set of parallel devices, or a parallel devices pool. Only TurboRESTORE can restore files stored in interleave format.

Before restoring files, determine the number of devices you want to use and the order in which to use them, then follow the instructions in this chapter for restoring files from incremental and full backup tapes.

### Using a Single Device

If you are using standard RESTORE, you can restore files from only one device at a time. When you use one backup device, RESTORE restores files from one tape at a time. After restoring all of the files from the first tape, RESTORE pauses while you unload the first tape and load a second. If your backup consists of several tapes, the RESTORE process could take a long time and require much attention.

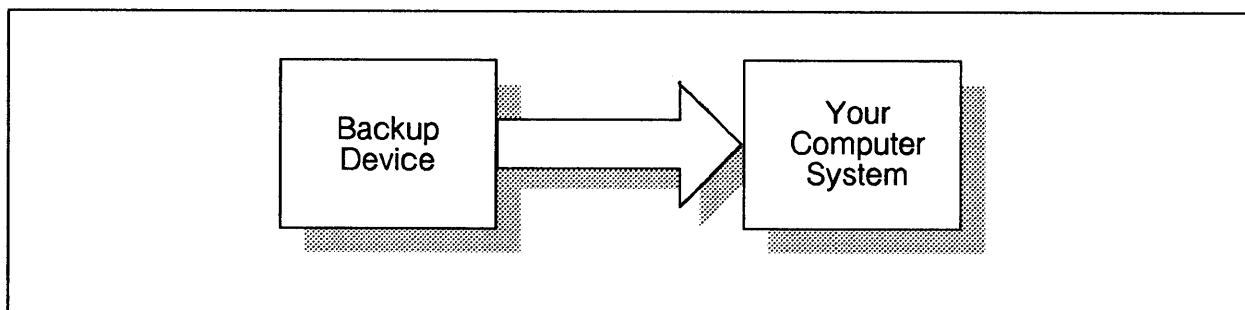

LG200021\_011

Figure 7-1. Restoring Files from a Single Device

### Using Sequential Devices

If you have the TurboSTORE version of RESTORE, you can restore files from a set of devices known as a sequential *device pool*. When RESTORE finishes restoring files from the tape on the first device, it immediately begins restoring files from the tape on the second device. By using this method to restore files, you save the time necessary to load, rewind, and unload tapes. While it is rewinding the tape on the last device, RESTORE has already begun restoring files from the next device.

When RESTORE has restored all files from the tape on the final device, and your backup contains additional tapes, :RESTORE begins restoring files from the first device and continues to cycle through all of the devices in the device pool until all of your files are restored.

You can use a maximum of four sequential devices.

TurboSTORE RESTORE does not support parallel devices or parallel device pools.

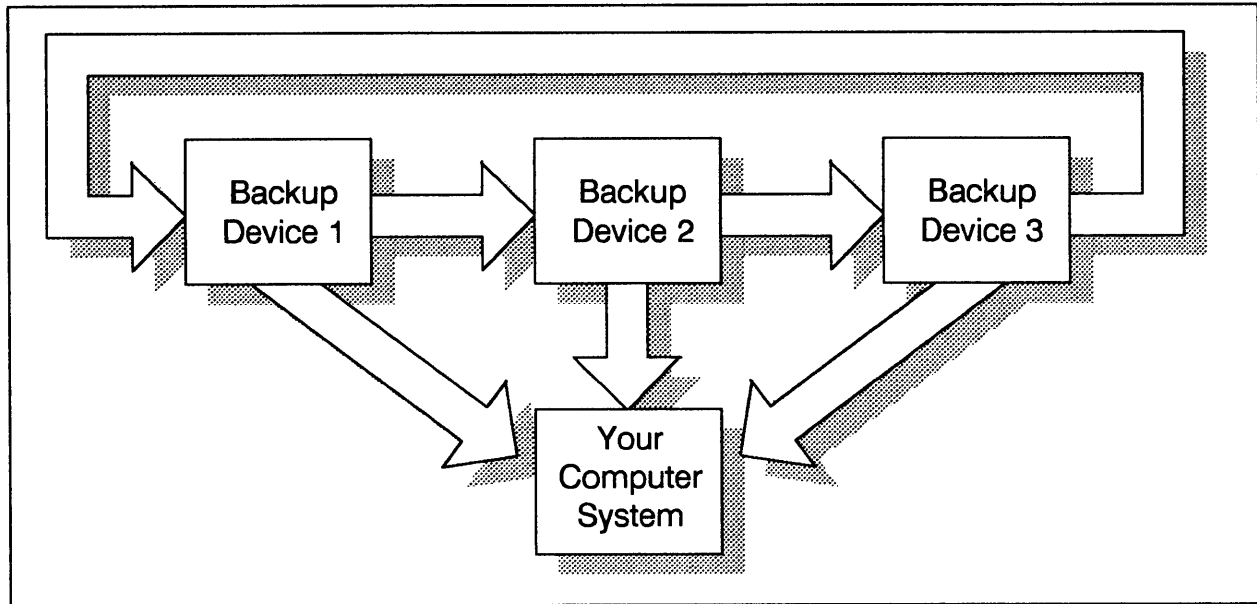

LG200021\_012a

Figure 7-2. Restoring Files from Sequential Devices

### Selecting a RESTORE Method

Restore files from a single device when you have only standard RESTORE, only one device, or only one backup tape. If you have several tapes, using TurboSTORE RESTORE and sequential devices reduces the time it takes to reload the files. In order to use sequential devices, your system must have several identical devices. Identical devices have the same device type, device subtype, density, and record size.

### Selecting Backup Devices

Once you've decided how you want to use your backup devices to restore files, determine each device's position in the procedure. Assign each device a position according to its LDEV number.

Figure 7-3 contains a chart for assigning your devices. Write the LDEV numbers of each device you plan to use in the position that you plan to use it. For example, if you intend to restore files from two sequential devices, write in the LDEV number of device 1 and the LDEV number of device 2. Photocopy the chart and use it as a guide while you restore files to your system.

<b>RESTORE DEVICES</b>			
Fill in LDEV numbers for each device you plan to use.			
Device 1 _____	Device 2 _____	Device 3 _____	Device 4 _____

Figure 7-3. RESTORE Device Chart

## FILE Commands for Multiple Devices

You restore files from your backup tapes with two commands. `:FILE` commands give your backup devices file names. A `:RESTORE` command instructs the system to restore files from those devices.

When you use multiple devices to restore files, you can either give each device a unique name based on its LDEV number or device class, or assign all of the devices a common name based upon their common device class. If you want devices to be automatically assigned (refer to Appendix F for details), you must assign devices file names based on their LDEV numbers.

**Assigning Unique File Names.** Assigning unique file names to your backup devices helps you to keep track of each device and its position in the backup. Assign names that describe each device's position. For example, if you are restoring files from two sequential devices, name the devices BACK1 and BACK2 with the following `:FILE` commands:

```
:FILE BACK1; DEV=TAPE
:FILE BACK2; DEV=TAPE
```

**Assigning Common Names.** If you assign a common file name to your backup devices, the system sends you a tape request for each device asking you to assign a LDEV number to the common file name. The tape requests are in order. For example, when you are restoring files from sequential devices, the first request is for device 1, the second request is for device 2, and so on.

## Restoring Files from Your Most Recent Backup Tapes

To restore system and user files from your most recent backup tapes:

1. First gather all the tapes from your most recent backup. If you have several tapes and several backup devices, you may choose to use multiple backup devices to restore the files.
2. Mount the tape(s) on the tape drive(s) and bring the drive(s) online.
3. If you are using a single device, issue the following `:FILE` and `:RESTORE` commands to restore the files from the tape(s).

```
:FILE T; DEV=TAPE
:RESTORE *T;@.@.@;KEEP;OLDDATE;CREATE
```

If you are using TurboSTORE and multiple devices, describe the devices with the `RESTORESET` parameter. The `:FILE` and `:RESTORE` commands in the following example restore files from two sequential devices.

```
:FILE BACK1; DEV=TAPE
:FILE BACK2; DEV=TAPE
:RESTORE @.@.@;KEEP;OLDDATE;CREATE;RESTORESET=(*BACK1,*BACK2)
```

4. Monitor the Console for tape requests, and answer them with the LDEV numbers of your backup devices. Refer to Appendix F for instructions.
5. Mount new tapes when necessary until you have restored all files from all tapes. Use the `:RECALL` command to redisplay mount requests.

## Restoring Files With ACDs

If your backup tape contains files with ACDs, you have the option of restoring the files with or without their ACDs. To ensure file security, restore the ACDs using the `COPYACD` parameter.

```
:RESTORE *T.●●●.COPYACD
```

The default is *not* to copy the ACD.

## Restoring Files from Full Backup Tapes

If your most recent backup tapes were from an incremental backup, locate your most recent full backup tapes and reload the files from them. Repeat the steps for restoring files from your most recent backup tapes.

## Reloading your System from a SYSDUMP Backup

When you use `SYSDUMP` to perform regular system backups, use the `RELOAD` option of the `INITIAL` program to reload all of the information on your backup tapes. Refer to the *System Operation and Resource Management Reference Manual* (32033-90005) for instructions.

There are two options available within the `RELOAD` option of the `INITIAL` program for reloading the system: `SPREAD RELOAD` or `ACCOUNTS RELOAD`.

With `SPREAD RELOAD`, you use sets of partial and full backup tapes. By using this method, you insure that files that were purged between the full and partial `SYSDUMPs` are not back on the system after the `RELOAD`. However, the system will not be available until all the tapes have been read in by the `INITIAL` program. Further, an irrecoverable error while `INITIAL` is reading the tapes will halt the `RELOAD`, which then must be started over from the beginning of the tapes.

With `ACCOUNTS RELOAD`, the operating system only and no user files are loaded. Once the operating system is loaded, users can resume using the system while the remaining user files are restored using the `:RESTORE` command. If an irrecoverable error is encountered by `:RESTORE`, you can re-start the `RESTORE` where it failed, skipping the defective file. Unlike the `SPREAD RELOAD` option, any files purged between full and partial backups (as well as accounts, groups, users, and passwords) will need to be re-purged after the `RELOAD`.

# Disaster Recovery

---

In this age of highly computerized business we constantly increase our dependence on the information stored and processed by our computer systems. Very often the information we rely on is only available through our computers. Regularly backing up the information stored on your computer system protects that information from a system failure. Your backup tapes and your computer system, however, are not indestructible and are threatened by smoke, noxious fumes, explosion, flood, earthquake, sabotage and many other natural and manmade problems. Without access to your computer system, you may lose track of sales, production, existing customers and accounting information.

This section discusses strategies for protecting computer operations from catastrophic disasters. Planning for a disaster and identifying the best means for recovering with a minimum of delay is the key to disaster recovery. Costs of disaster recovery systems vary greatly depending upon the alternative you select and the features you require. However, if a properly designed disaster recovery system saves your business, you will want it at any cost.

## Recovery Facilities

The best way to prepare for an unpredictable disaster is to have a recovery facility available. A recovery facility contains a backup system onto which you can reload your files from backup tapes. You can use the backup system for all of your information processing needs until your system is repaired or replaced. There are several types of recovery facilities, select the type that best meets the needs of your Data Center.

### Private Recovery Facilities: Standby Sites and Fully-equipped Sites

A private recovery facility is owned and maintained by your company. It is usually located at a facility close to but separate from your Data Center. There are two types of private backup sites: *standby sites* and *fully-equipped sites*.

#### Standby Sites

A standby site is a facility with sufficient electrical power, air conditioning, and telecommunications equipment to support a computer system, but does not contain an actual computer system. If a disaster occurs, you must obtain the computer and the necessary peripherals to support your information processing requirements. The standby backup site offers guaranteed access at a relatively low cost, but requires considerable time to obtain, install, and test a new computer system.



## **Fully-equipped Sites**

A fully-equipped site is a standby site with an operational computer system similar, if not identical, to the one you intend to protect. If a disaster occurs, you can reload your information on the backup system at the fully-equipped site. This alternative is the quickest, but most costly, method for recovering from a disaster. Because of the cost of maintaining a complete backup system, companies with fully-equipped sites sometimes begin using the backup system for regular information processing.

## **Mutual Backup Arrangements**

Another recovery site option is a *mutual backup arrangement*. A mutual backup arrangement is an agreement between two companies with similar computer systems to provide the use of their Data Centers to one another should a disaster occur. Usually the two businesses are located close to one another. Some companies seek partners in different industries to eliminate competition or protect confidentiality. A mutual backup arrangement can provide both a quick and cost-effective recovery facility, but may not work well if either party is unwilling to disrupt its information processing to accommodate the other party. Contractual and legal problems sometimes arise in this type of agreement.

## **Hewlett-Packard Disaster Recovery Services**

Hewlett-Packard offers a full range of disaster recovery services. Contact your local Hewlett-Packard representative for more information.

## **Commercial Backup Companies**

Commercial backup companies offer fully-equipped and standby backup sites identical to private fully-equipped and standby sites except that the site is owned and operated by a company in the disaster recovery business. A commercial backup site is less costly than a private backup site, but has the disadvantage that the clients of the backup company could potentially compete for backup resources at the same time. For example, in the event of a widespread natural disaster such as an earthquake or a flood, many businesses may need the backup facility at the same time.

## **Computer Service Bureaus**

Some companies use a Computer Service Bureau in the event of a disaster. Although such an arrangement is generally available, it is often costly, restricts computer use, causes capacity and compatibility problems, and ignores special computer requirements.

## **Planning for Disaster Recovery**

Selecting a recovery facility is only part of a comprehensive disaster recovery program. You should prepare and implement a comprehensive disaster recovery plan. Your plan should detail resource requirements and procedures for each step in the recovery process.

## **The Recovery Facility**

Locate your recovery facility close to the computer system you want to protect, but not in the same building or group of buildings. It should be in a different power distribution system. If you think your system may be damaged by a major earthquake, locate the recovery facility in another region of the country.

The facility should have adequate security, provided by either security guards or controlled system access.

## **System Compatibility**

The disaster recovery computer system must be compatible with your Data Center computer system. The main memory, disc drives, tape drives, and printers should allow you to perform necessary recovery operations without requiring you to reconfigure your system. The recovery computer system should also be expandable to meet your future needs.

The number of telephone lines into the disaster recovery facility should be sufficient to support recovery operations. Telephone lines should be either of voice or data quality, depending on your requirements. Data communications equipment must be compatible with your data transmission requirements. Pay attention to required baud rates and other special requirements.

Name representatives from your Data Center and the disaster recovery facility who will keep in frequent contact to ensure continued compatibility between computer systems. They ensure that changes made in either system do not affect the disaster recovery capability, and that upgrades in the Data Center computer system are quickly reflected in the disaster recovery computer system.

## **Disaster Notification and Response Time**

A disaster can occur any time without warning. Your recovery center should be available 24 hours a day. The time from when you notify the recovery center to the time that your backup system is up and running is called *response time*. Response time requirements vary depending upon the business situation. A response time of four hours is normally considered a quick turnaround.

Only authorized personnel should notify the disaster recovery facility to initiate disaster recovery. They should identify themselves to the disaster recovery facility by a pre-arranged codeword; and, of course, the disaster recovery facility personnel must act quickly and report promptly for recovery operations.

## **Storing Backup Tapes**

If you store your regular backup tapes at your Data Center and the Data Center is destroyed by fire, the tapes are also destroyed. Create a duplicate set of backup tapes to store at a suitable off-site storage facility. In this way, you have a set easily accessible for routine problems and a set available in case of a major disaster. Arrange to have around-the-clock access to the tapes, and to have them quickly delivered to the disaster recovery facility when necessary.

## **Testing Your Recovery System**

When you initiate a disaster recovery service contract, use backup tapes to test for system-compatibility problems and bugs in your disaster recovery system. As time passes, perform periodic tests (for example, every quarter) to ensure that your systems remain compatible and your disaster recovery procedures work well. Also test your disaster recovery system whenever you change it. You can either notify the facility in advance, to minimize costs and interruption of the recovery facility, or you can do a full-scale simulation. Either way, prepare a test plan and have it approved by all parties.

## Determining the Cause of STORE and RESTORE Errors

---

Some STORE and RESTORE errors cause the program not to store or restore a particular file. Others cause the program to stop running. When STORE or RESTORE cannot transfer files that you named in your command, it lists the names of those files on your terminal as part of its standard listing. When STORE or RESTORE aborts because of an error. You see one of the following messages:

```
STORE ABORTED BECAUSE OF ERROR
```

or

```
RESTORE ABORTED BECAUSE OF ERROR (CIERR 1091)
```

You can use the STOREJCW job control word (JCW) to determine the cause of an error and a proper recovery procedure. Each time you issue a :STORE or :RESTORE command, STORE/RESTORE updates the value assigned to STOREJCW. When STOREJCW is equal to 0, for example, the command executed successfully. STOREJCW values greater than 0 alert you to the cause of an error.

In addition to the above, if you receive the following error message:

```
INTERNAL ERROR - TRYING TO OPEN LIST FILES (S/R 6287)
```

it is because you have run out of disc space. Running out of disc space may occur for one of the following three reasons:

- 1) You are using interleaved format which requires a few more internal files.
- 2) You have requested too many files with the FILES= parameter.
- 3) You are using the LONG, DATES and/or SECURITY options of the SHOW= parameter.

Here are some suggestions to remedy the situation:

- Specify a smaller number of files with the FILES= parameter.
- Make more disc space available by purging unnecessary files.
- Do not specify the LONG, DATES and/or SECURITY option with the SHOW= parameter.

## Viewing the Value of STOREJCW

To view the value assigned to STOREJCW, use the following :SHOWJCW command:

```
:SHOWJCW STOREJCW
```

The system reports the current value. For example:

```
STOREJCW=4
```

## Determining the Cause of an Error

The value of STOREJCW after you issue a :STORE or :RESTORE command tells you the cause of any errors in storing or restoring the files you named. To determine the cause of an error:

1. Use the :SHOWJCW command to view the value of STOREJCW.
2. Look up that value in Table A-1. In addition to the cause of an error, Table A-1 displays recommended recovery procedures.

**Table A-1. STOREJCW Values**

<b>Value</b>	<b>Cause</b>	<b>Recovery Procedure</b>
0	No errors	None
1	Syntax error	Enter the command again.
2	Error in opening internal file.	Purge the files or perform disc space recovery.
3	Error in opening an indirect file.	Does the indirect file you named exist? Do have adequate access to it? Is it in use? Is the redirect file an EDIT file?
4	Error in opening the tape file.	Is the :FILE command describing the tape drive correct? Is the tape on the device you named? Unload and reload the tape. If you are restoring files, check whether you have adequate access to them.
5	Error scanning the files.	Make sure the file names are syntactically correct and correctly spelled.
6	Error in actually storing or restoring files.	Enter the command again. After a second failure, contact your System Manager.
7	A file you attempted to store does not exist on disc, a file you attempted to restore does not exist on the STORE tape, or the system could not find files that matched the pattern you specified (for example: FEB@).	Did you name the files correctly in the :STORE or :RESTORE command? Do the files you want to store or restore exist?
8	A file that you tried to store or restore was in use.	Wait until the file is no longer in use. Enter the command again.

# Command Syntax

---

This appendix contains the syntax of the :STORE and :RESTORE commands.

## :STORE Syntax

The STORESET and INTERLEAVE parameters are available only with TurboSTORE. ■

```

:STORE [[{ fileset[- fileset ][,fileset[- fileset]] [ ,... ]}]
      [ {!indirectfile } ]

[{:*storefile}]
[{:storefile}]

[; SHOW[=showparm[ , showparm[ ,...]]]

[;FILES=maxfiles ]

[;DATE[ { <= acctdate }
        { >= moddate } ]

[;ONERR[or]= { QUIT }
            { REDO } ]

[;PURGE]

[;PROGRESS[ =#minutes] ]

[;STORESET=tapelistspec]

[;INTER[ leave ] ]

[;COPYACD]

```

LG200021\_040

## :RESTORE Syntax

- The RESTORESET parameter is available only with TurboRESTORE.

```
:RESTORE [ restorefile ] [ ; { fileset[- fileset ][,fileset[- fileset ]][ ,... ] } ]  
    [ ; { indirectfile } ]  
  
    [ ;DEV=device ]  
    [ ;SHOW=[showparm[ , showparm[ ,...]] ] ]  
    [ ;FILES=maxfiles ]  
  
    [ ; { { LOCAL  
    ; { { GROUP= groupname } [ ;... ] }  
    { ACC[oun]T= acctname } } } ] ]  
  
    [ ;CREATE[ = { GROUP  
    ACCT  
    CREATOR } [ ;... ] ] ]  
  
    [ ;CREATOR[ = username ] ]  
  
    [ ; { KEEP  
    ; { NOKEEP } } ] ]  
  
    [ ; { OLDDATE  
    ; { NEWDATE } } ] ]  
  
    [ ;ONERR[or]= { QUIT  
    SKIP } ] ]  
  
    [ ;RESTORESET= tapel/stspec ]  
    [ ;STARTHERE ]  
    [ ;COPYACD ]
```

LG200021\_041a



# **STORE Tape Formats**

---

This appendix describes the formats of standard STORE tapes and interleave STORE tapes. You can only create interleaved STORE tapes with TurboSTORE.

# Standard STORE Tape Format

Figure C-1 shows standard labeled and unlabeled STORE tape formats.

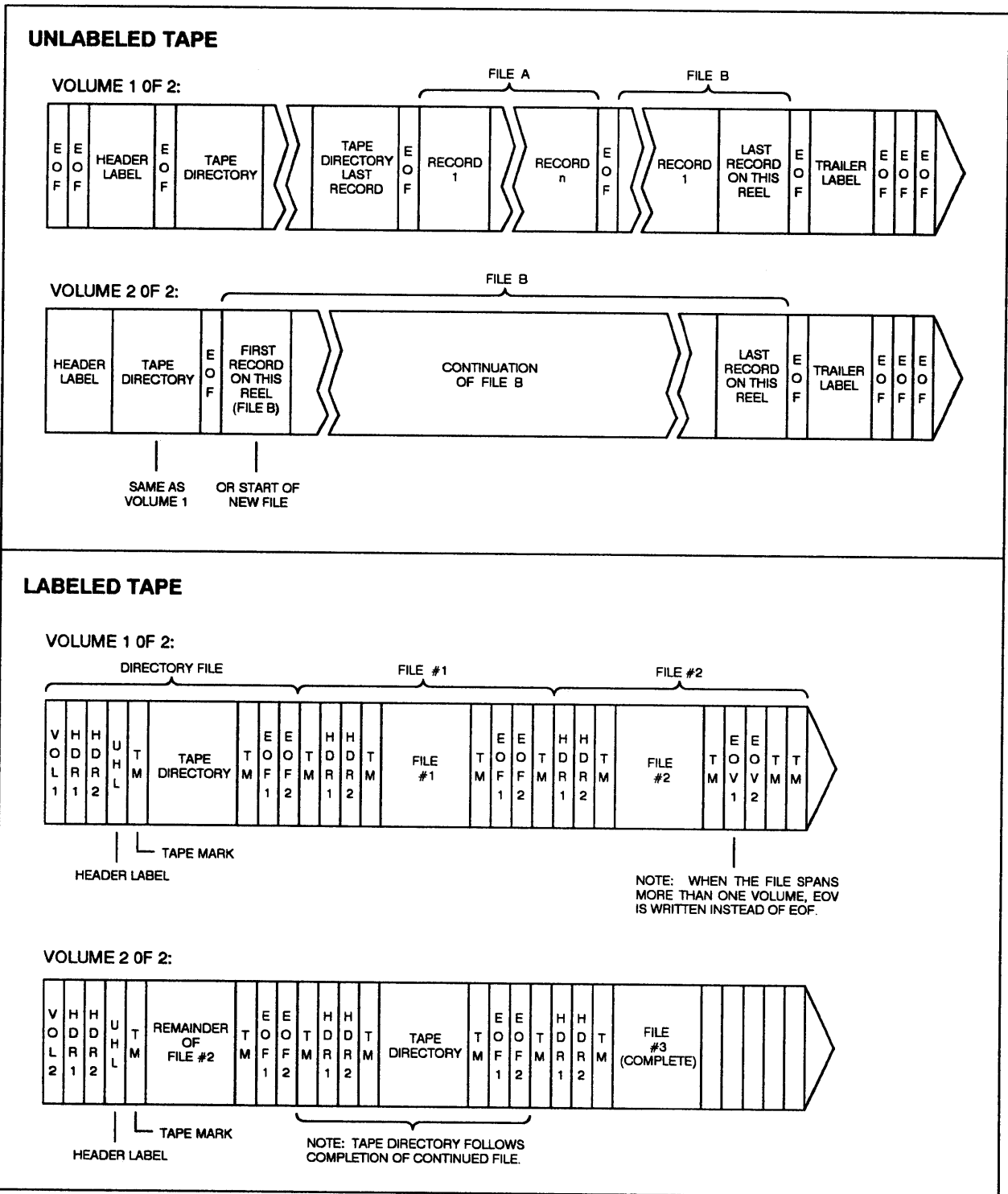

LG200028\_048a

Figure C-1. Standard STORE Tape Formats

# STORE Tape Format with ACD Extensions

Figure C-2 shows STORE tape formats when COPYACD is used.

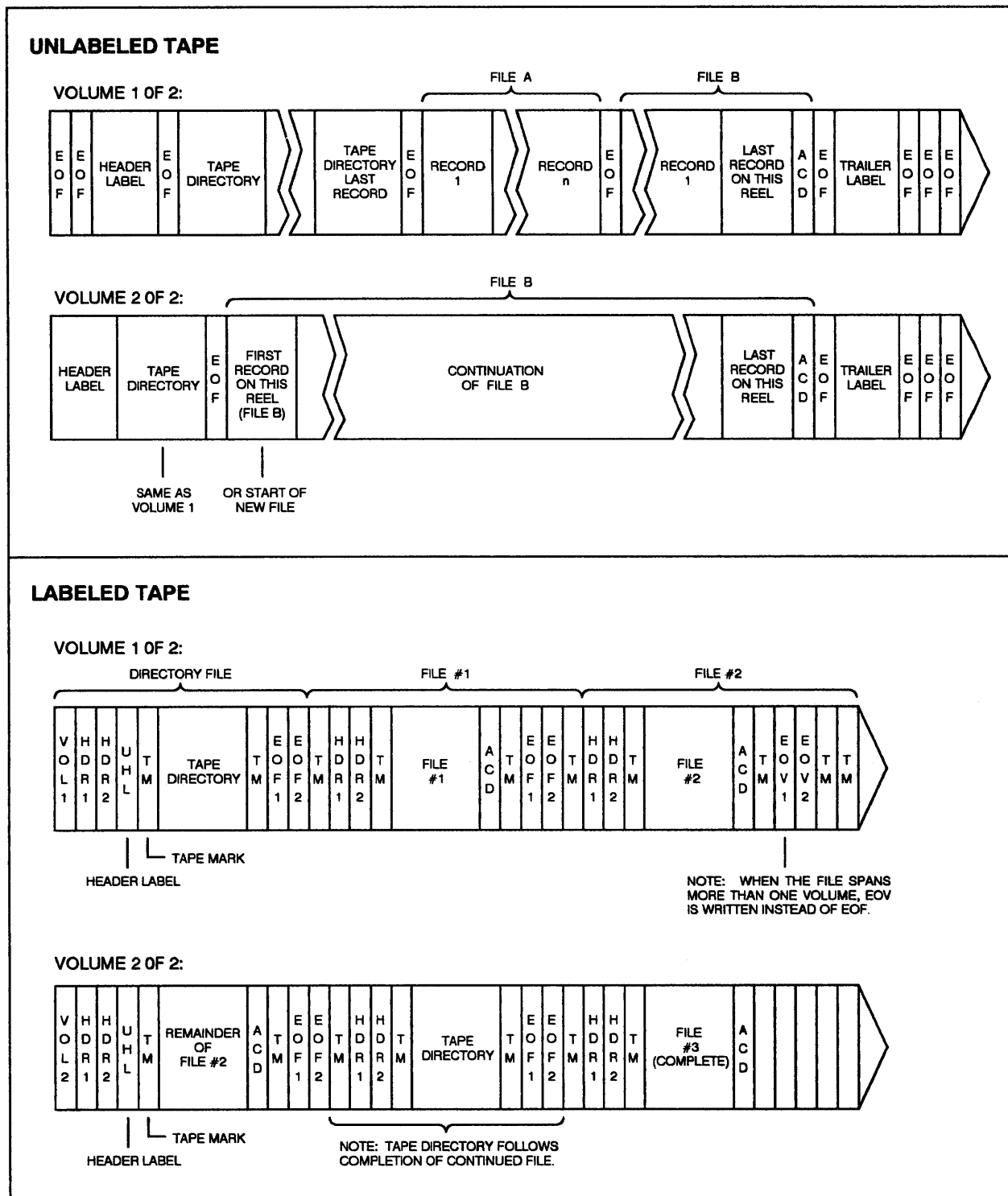

LG200028\_048b

Figure C-2. STORE Tape Formats with ACD Extensions

# Interleave Tape Format

TurboSTORE lets you store files in interleave format. Figure C-2 shows the format for interleave tapes. Interleave format interleaves blocks from different files. End-of-file marks signal the *beginning* of a file on an interleave tape. RESTORE uses these end-of-file marks to search for a particular file you want to restore.

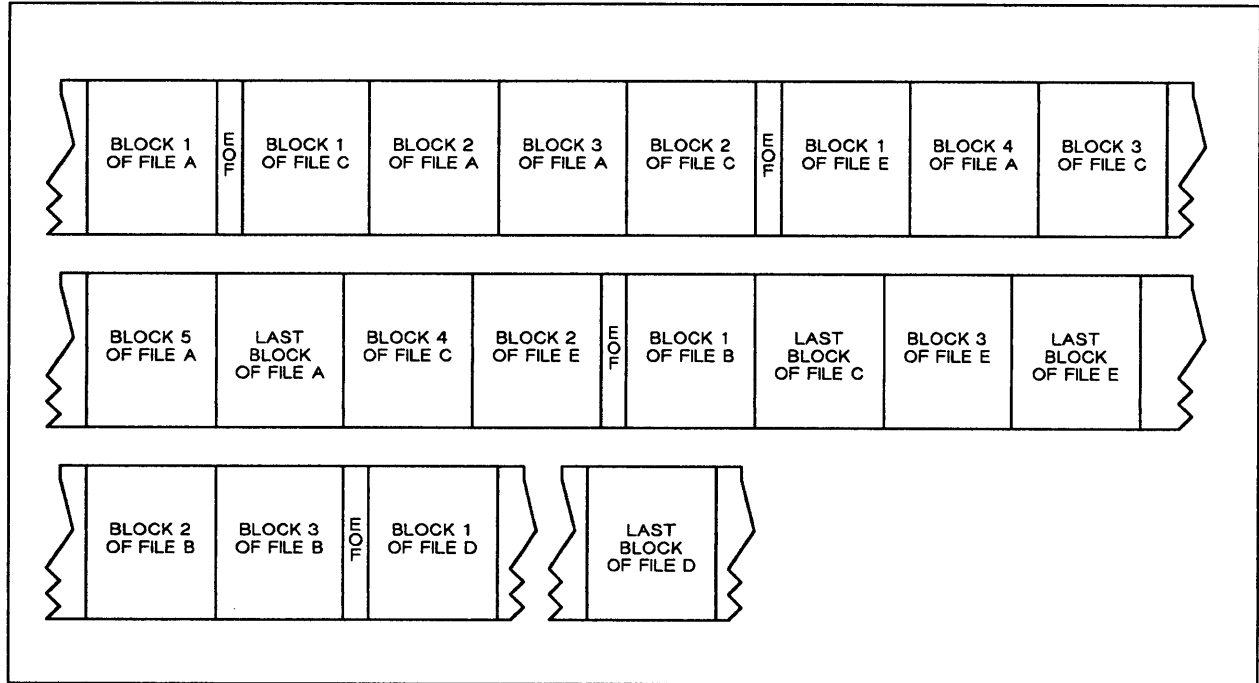
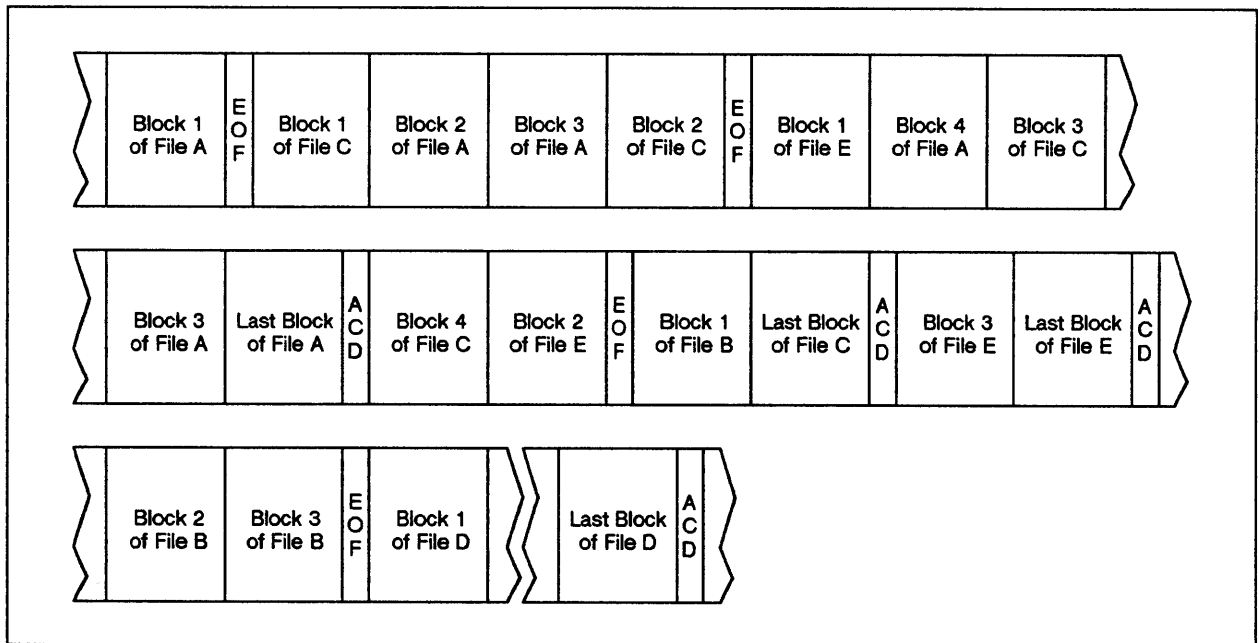

Figure C-3. Interleave Tape Format



LG200028\_049

Figure C-4. Interleave Tape Format with ACIDs

## STORE and RESTORE Versions

---

There are two versions of STORE and RESTORE. Standard STORE and RESTORE let you transfer files to and from a single backup device with the :STORE and :RESTORE commands. TurboSTORE adds capabilities to the :STORE and :RESTORE commands. TurboSTORE lets you transfer files to and from multiple backup devices; it also lets you store files in interleave format. TurboSTORE is a product that you must purchase separately from the standard MPE V fundamental operating software.

This appendix tells you how to determine whether your system is running standard STORE and RESTORE or TurboSTORE.

### Running STORE.PUB.SYS

The program files for the :STORE and :RESTORE commands reside in a single program file named STORE.PUB.SYS. To determine which version of STORE and RESTORE your system is running, run STORE.PUB.SYS. Enter:

```
:RUN STORE.PUB.SYS
```

The system prints a *version banner* and a prompt. The version banner tells you which version of STORE and RESTORE your system is running.

### Standard STORE and Restore

If your system is running standard STORE and RESTORE, you see a version banner like the one shown in Figure D-1.

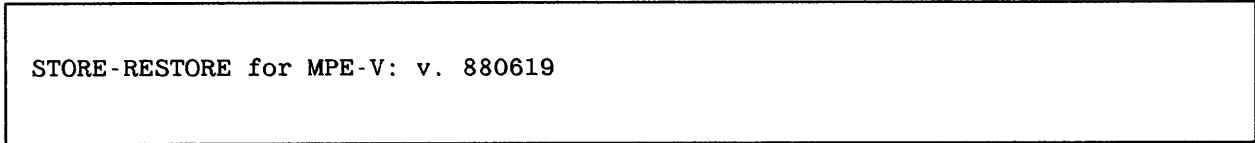

```
STORE-RESTORE for MPE-V: v. 880619
```

Figure D-1. Standard STORE/RESTORE Banner

# TurboSTORE

If you have purchased and installed TurboSTORE, you see a version banner like the one in Figure D-2.

```
TurboSTORE for MPE-V, v. 880617
```

Figure D-2. TurboSTORE Banner

## Exiting STORE.PUB.SYS

Following the version banner you see a STORE/RESTORE prompt (<--). In response, you can enter a :STORE or :RESTORE command or exit STORE.PUB.SYS. To exit the STORE.PUB.SYS program, enter:

```
<--EXIT
```

# Backup Device Configurations

---

TurboSTORE lets you perform backups to multiple backup devices. Table E-1 contains recommended backup device configurations. The recommendations are based on preliminary performance testing. You may want to experiment with several configurations to find the one that works best for your system.

In general:

- Use interleave format when your files are spread evenly across system discs.
- Configure your backup devices on a separate General Interface Controller (GIC) or Peripheral Interface Controller (PIC) from system discs.
- Configure each HP 7980 tape drive on a separate GIC.

**Table E-1. Backup Device Configurations**

System	Backup Devices	Recommended Method
Series 37 MICRO 3000 MICRO 3000 XE	1 HP 7974, HP 9144, HP 35401A 2 HP 7974, HP 9144, HP 35401A	Single device, Interleave format Parallel devices, Interleave format
Series 58	1 HP 7974, HP 7978, HP 7979, HP 7980, HP 9144, or HP 35401A 2-4 HP 7974, HP 7979, HP 9144, HP 35401A 2 HP 7978 4 HP 7978 2 HP 7980	Single device, Interleave format Parallel devices, Interleave format Parallel devices, Interleave format 2 parallel device pools, Interleave* Sequential devices, Interleave
Series 70 (1 or 2 IMB)	1 HP 7974, HP 7978, HP 7979, HP 7980, HP 9144, or HP 35401A 2-4 HP 7974, HP 7979, HP 9144, HP 35401A 2 HP 7978 4 HP 7978 2 HP 7980	Single device, Interleave format Parallel devices, Interleave format Parallel devices, Interleave format 2 parallel device pools, Interleave* Sequential devices, Interleave
Series 70 (3 IMB)	1 HP 7974, HP 7978, HP 7979 HP 7980 2-4 HP 7974, HP 7979 2-4 HP 7978 2 HP 7980 4 HP 7980	Single device, Interleave format Parallel devices, Interleave format Parallel devices, Interleave format Parallel devices, Interleave format 2 parallel device pools, Interleave*

\* When using four devices, group them into two parallel device pools.  
Give each pool two sequential devices



# Managing Backup Devices

---

This appendix contains a quick-reference guide to procedures you use to manage backup devices. It describes the following procedures:

- Replying to a tape request
- Automatically assigning devices
- Mounting reel-to-reel tapes
- Unloading reel-to-reel tapes
- Preparing cartridge tapes
- Loading cartridge tapes onto HP 9140 and HP 9144 tape drives
- Unloading cartridge tapes from HP 9140 and HP 9144 tape drives
- Loading cartridge tapes into HP 35401A tape drives
- Unloading cartridge tapes from HP 35401A tape drives

## Replying to a Tape Request

STEP	PROCEDURE
1	<p>Locate the STORE or RESTORE PIN in the tape request. The PIN follows the second slash mark in the tape request. In the following tape request, the PIN is 23.</p> <pre>?16:04/#S37/23/LDEV# for "T" on TAPE (NUM)?</pre>
2	<p>Use the :REPLY command to assign a tape LDEV number to the PIN. For example:</p> <pre>:REPLY 23,8</pre> <p>To deny the user access to a device, enter 0 in your :REPLY command. For example:</p> <pre>:REPLY 23,0</pre>

## Automatically Assigning Backup Devices

STEP	PROCEDURE
1	<p>Configure your devices so that they are automatically assigned to STORE or RESTORE. Each device must have the following characteristics:</p> <ul style="list-style-type: none"><li>▪ The device mode must be R (Auto Reply).</li><li>▪ The device must not be JOB or DATA accepting.</li><li>▪ The device must not be assigned to another user.</li><li>▪ The device specification, logical device number, or device class name must be unique.</li></ul>
2	Use unlabeled tapes to STORE or RESTORE files.
3	Name the device and its LDEV number or unique device class in a file command preceding your :STORE or :RESTORE command. The device must not be in use.

## Mounting a Reel-to-Reel Tape

STEP	PROCEDURE
1	Remove the plastic band that protects the tape.
2	Locate the circular groove on the back surface of the tape reel. To prepare the tape for storing files, insert a write ring into the groove. To prepare the tape for restoring files, make sure the reel does not have a write ring.
3	Open the door of the tape drive. Flip up the latch on the empty spool.
4	Place the tape reel onto the empty spool. Press down the latch to lock the reel in place.
5	Unwind about four feet of tape from the reel. Thread the unwound tape around the spools using the diagram on the tape drive as a guide.
6	Guide the tape onto the permanent reel. Hold the end of the tape in place on the permanent reel, and turn the reel several times.
7	Shut the tape drive door, and press the LOAD button.
8	Press the ONLINE button.

## Unloading a Reel-to-Reel Tape

STEP	PROCEDURE
1	Wait until the tape stops moving.
2	Press the rewind button. The tape rewinds off of the permanent reel.
3	Open the tape drive door. Flip up the latch and remove your reel.

## Preparing a Cartridge Tape

STEP	PROCEDURE
1	To prepare a cartridge tape for storing files onto it, turn the write-enable lock so that its arrow points away from the word SAFE.
2	To prepare a cartridge tape for restoring files from it, turn the write-enable lock so that its arrow points towards the word SAFE.

## Loading a Cartridge Tape: HP 9140 and 9144

STEP	PROCEDURE
1	Insert the tape into the tape drive.

## Unloading a Cartridge Tape: HP 9140 and HP 9144

STEP	PROCEDURE
1	Press the UNLOAD button.
2	Wait for the BUSY light to go out.
3	Eject the tape by pressing the button directly below the tape compartment.



## Loading Cartridge Tapes: HP35401A

STEP	PROCEDURE
1	Insert the cartridges into the slots in the magazine so that:
2	<ul style="list-style-type: none"><li>▪ The metal plate on each cartridge faces downwards, the write-protect switch upwards, and the head-access door and drive wheels face toward you as you put each cartridge into the magazine.</li><li>▪ The tapes are in the correct order if it is important. The bottom tape should be the first to use, the second tape is the second to use, and so on.</li></ul>
3	Press the EJECT button to open the front door of the tape drive.
4	Lower the magazine into the tape drive. Make sure the open side of the magazine faces the back of the drive and that the magazine slides down the guides on the door.
5	Push the door shut. It automatically locks.

# Unloading Cartridge Tapes: HP 35401A

STEP	PROCEDURE
1	<p>Press the EJECT button. The front door opens and the cartridge number display shows the letter E.</p> <p>Lift the magazine out of the drive.</p> <p>Store the cartridges in the magazine, or push them through the slots at the back of the magazine to release and remove them. If you take them out, store cartridges in their plastic cases.</p>

# Index

---

## Symbols

:BREAKJOB command, 3-3  
:FULLBACKUP command, 5-3  
:HELLO command, 3-2  
:HIPRI parameter, 3-2  
:JOB command, 3-2  
:JOBFENCE command, 3-1  
:LIMIT command, 3-1, 3-4  
:PARTBACKUP command, 5-4  
:RECALL command, 3-3, 4-25  
:RESTORE command, 7-4  
:RESTORE syntax, B-2  
:RESUMEJOB command, 3-5  
:SHOWJOB command, 3-2  
:STORE syntax, B-1  
:TELL command, 3-1  
:WARN command, 3-2

## A

Access Control Definitions, 4-18  
ACDs, 4-18  
Automatically assigned devices, 4-17

## B

Backing up, 1-1  
Backup devices, 4-1  
Backup media, 1-1  
Backup method, 2-1  
Backup options, 4-1  
Backup schedule, 1-1  
Backup tapes, 2-4

## C

Cold load tape, 2-1, 2-2, 5-2

Commercial backup companies, 8-2  
Common file names, 7-4  
Compatibility, 4-7, 4-18A  
Computer service bureaus, 8-2  
COPYACD, 6-2  
Correctly labelled tape, 4-12

## D

Device configurations, E-1  
Device pool, 4-3  
Disaster notification response time, 8-3  
Disaster recovery, 1-2, 8-1  
Disaster recovery plan, 1-2  
Disaster recovery services, 8-2

## F

FILE commands, 4-17, 7-4  
File set characteristics, 4-7  
Full backup, 2-2, 5-3  
Full backup tapes, 7-5

## I

Incremental backup, 2-2, 5-4  
Interleaved format, 4-6, 4-23, C-3

## K

Keeping records, 2-4

## L

LDEV numbers, 4-9, 7-4  
Loading cartridge tapes, F-7, F-9  
  HP 9140 and 9144, f-7  
  HP35401A, F-9

# Index (Continued)

---

## M

- Managing backup devices, F-1
  - automatically assigning backup devices, F-3
  - mounting a reel-to-reel tape, F-4
  - preparing a cartridge tape, F-6
  - replying to a tape request, F-2
  - unloading a reel-to-reel tape, F-5
- Managing backups, 2-1
- Monitoring progress, 4-23
- Most recent backup tapes, 7-4
- Mounting additional tapes, 4-25
- Multiple backup devices, 4-17
- Multiple-device backups, 4-7
- Mutual backup arrangements, 8-2

## N

- NO WRITE RING message, 4-24

## O

- Other uses of SYSDUMP, 5-5
  - carriage return SYSDUMP, 5-5
  - future date SYSDUMP, 5-5
  - programmatic SYSDUMP, 5-6

## P

- Parallel device pools, 4-5, 4-22
  - full backup, 4-22
  - incremental backup, 4-22
- Parallel devices, 4-4, 4-21
  - full backup, 4-21
  - incremental backup, 4-21
- Preparing backup devices, 4-17
- Preparing backup media, 4-10
- Preparing your media, 4-13
- Preparing your system for a backup, 3-1
- Preventing system activity, 3-1

- Private recovery facilities, 8-1
  - Fully-equipped sites, 8-2
  - standby sites, 8-1
- Progress messages, 4-24

## R

- REPLY command, 4-23
- RESTORE devices, 7-3
- RESTORE errors, A-1
- RESTORE methods, 7-3
- RESTORE versions, D-1
- Recovery facilities, 8-1
- Recovery facility, 8-3
- Redirecting output, 5-1
- Reel-to-reel tapes, 1-1
- Regular backups, 1-1
- Reloading files, 7-1
- Reloading system configuration, 7-1
- Reloading your system, 7-5
- Replying to console requests, 3-3
- Resetting job limits, 3-4
- Resetting session limits, 3-4
- Resetting the jobfence, 3-5
- Responding to tape requests, 4-23
- Restarting jobs, 3-5
- Restoring files, 7-2
  - RESTORE program, 7-2
  - standard RESTORE, 7-2
  - TurboRESTORE, 7-2
  - using a single device, 7-2
  - using sequential devices, 7-2

## S

- Scheduling backups, 2-2
- Security considerations, 4-18A
- Selecting backup devices, 4-9, 7-3
- Sequential devices, 4-3, 4-20
  - full backup, 4-20
  - incremental backup, 4-20

# Index (Continued)

---

Serial discs, 1-1  
SHOW=OFFLINE parameter, 2-4  
Single device, 4-2, 4-19  
    full backup, 4-19  
    incremental backup, 4-19  
STORE backup, 4-1  
STORE errors, A-1  
STORE versions, D-1  
STORE.PUB.SYS, D-1  
STOREJCW, A-2  
STOREJCW values, A-3  
Standard STORE, 4-1  
Standard STORE tape format, C-2  
Stopping jobs, 3-3  
Store, 2-2  
Storing backup tapes, 2-4, 8-3  
Storing files, 4-17  
SYSDUMP, 2-2  
SYSDUMP backup, 5-1  
System backups, 1-1  
System compatibility, 8-3  
System configuration, 2-1, 4-8  
System failure, 1-1

System failure recovery, 7-1  
System files, 2-1

## T

Tape formats, C-1  
Tape labels, 4-13  
Tape library, 2-4  
Testing recovery system, 8-4  
TurboSTORE, 4-1  
TurboSTORE backup, 6-1  
    full backup, 6-1  
    incremental backup, 6-3

## U

Unique file names, 7-4  
Unloading cartridge tapes, F-8, F-10  
    HP 9140 and HP 9144, F-8  
    HP35401A, F-10  
User files, 2-1

## W

Write ring, 4-24

# READER COMMENT SHEET

Information Technology Group

MPE V Backup and Recovery  
User's Guide

Manual Part Number 32033-90134      October 1988

A reader comment sheet helps us to improve the readability and accuracy of the document. It is also a vehicle for recommending enhancements to the product or manual. Please use it to suggest improvements.

SERIOUS ERRORS, such as technical inaccuracies that may render a program or a hardware device inoperative should be reported to your HP Response Center or directly to a Support Engineer. An engineer will enter the problem on HP's STARS (Software Tracking and Reporting System). This will ensure that critical and serious problems receive appropriate attention as soon as possible.

**Editorial suggestions (please include page numbers):** \_\_\_\_\_

---

---

---

**Recommended improvements (attach additional information, if needed):** \_\_\_\_\_

---

---

---

Name \_\_\_\_\_ Date \_\_\_\_\_

Job Title \_\_\_\_\_ Phone \_\_\_\_\_

Company \_\_\_\_\_

Address \_\_\_\_\_

HP 1000 Series \_\_\_\_\_ (e.g., E-series, A400, A600, etc.)

HP 3000 Series \_\_\_\_\_ (e.g., 37, 68, 930, etc.)

HP 9000 Series \_\_\_\_\_ (e.g., 300, 840, etc.)

Check here if you would like a reply.

Hewlett-Packard has the right to use submitted suggestions without obligation, with all such ideas becoming property of Hewlett-Packard.

Fold  
Here



NO POSTAGE  
NECESSARY  
IF MAILED  
IN THE  
UNITED STATES



**BUSINESS REPLY MAIL**  
FIRST CLASS PERMIT NO. 1070, CUPERTINO, CA 95014

- POSTAGE WILL BE PAID BY -

Publications Manager  
Hewlett-Packard Company  
Information Technology Group  
19483 Pruneridge Avenue  
Cupertino, California 95014-9974

Fold  
Here



Manual Part Number 32033-90134  
Printed in U.S.A. June 1987  
U1088

