

MASSACHUSETTS INSTITUTE OF TECHNOLOGY

PROJECT MAC

Artificial Intelligence  
Memo. No. 178

August 1969

The Image Dissector 'eyes'

B.K.P. Horn

This is a collection of data on the construction operation and performance of the two image dissector cameras. Some of this data is useful in deciding whether certain shortcomings are significant for a given application and if so how to compensate for them.

## INTRODUCTION:

The following is a collection of bits and pieces of information about the two image dissector cameras attached to the computers (PDP-6 and PDP-10) of the Artificial Intelligence Group at Project MAC. Most of this data concerns the 'new' 'eye' and the video-processor which can be used to access both 'eyes'.

The new vidisector contains a F4010 tube manufactured by ITT Industrial Laboratories (ITTIL). This tube has a diameter of 4.5" (118 mm), a length of 14.5" (368 mm), a S-11 (Cs-Sb) photocathode with a 3" (76 mm) useable diameter. The circular aperture has a diameter of .002" (.05 mm) and the electron-multiplier consists of 14 dynodes. The claimed resolution is 10 cycles (line-pairs) per mm at 50 % amplitude response, and 17 cycles/mm at 10 % amplitude response. The face-plate has a thickness of .125" (3.2 mm).

The old vidisector contains a F4011 tube manufactured by ITTIL. It has a diameter of 1.5" (38 mm), a length of 8.2" (205 mm), a S-11 photocathode with a 1.1" (28 mm) useable diameter. The circular aperture has a diameter of .001" (.025 mm) and the electron-multiplier consists of 10 dynodes. The claimed resolution is 20 cycles/mm at 50 % amplitude response, and 34 cycles/mm at 10 % amplitude response. The face-plate has a thickness of .080" (2.0 mm).

For further information on image dissectors see:

"SPECIAL PURPOSE VACUUM TUBES" ITTIL

"APPLICATIONS NOTE B6, UNIQUE PROPERTIES OF  
IMAGE DISSECTORS" ITTIL

"TENTATIVE DATA - VIDISSECTORS - IMAGE

"DISSECTOR TYPE F4010 (or F4011)" ITTIL

"RESEARCH MEMOS 309, 336, 337, 353, 386 ITTIL

The video-processor was supplied by Information International Inc. and is described in:

"OPERATION MANUAL - IMAGE DISSECTOR CAMERA SYSTEM"  
III

Further information about the use of our video processor can be found in an appendix to:

"FOCUSING" AI Memo 160

## THE EYE: PRINCIPLES OF OPERATION:

The main component of the eye is the image disector camera (vidi~~s~~-sector for short). It is an evacuated tube coated on one end with a substance that converts a certain fraction of incoming photons into electrons. By means of a large applied potential and an axial magnetic field most of these electrons are imaged onto an aperture plate (see Fig 1 ). The electrons travelling through the aperture all come from a small area on the photocathode of approximately the same size as the aperture. These electrons now enter an electron multiplier where secondary emission produces a large number of new electrons as this stream of electrons impinges successively on each of 14 suitably coated dynodes. The current in the **anode** is converted to a voltage which is directly proportional to the illumination falling on the small area on the photocathode selected.

With only the axial focusing field this small area is in the centre of the photocathode. Two perpendicular radial fields allow one to move the electron image around on the aperture plate thus selecting different areas of the image. Attached to this device is the video-processor which includes the interface with the computer.

The complexity of the video-processor is in large part due to two design objectives:

1. Relative error in an intensity measurement should be independent of the intensity.
2. The video-processor should not waste time processing very dark points.

The main source of error in an intensity measurement is caused by quantisation - in effect we are counting electrons (The only reason for not actually counting them is that they may arrive at a rate of up to  $2^8$  per sec). To obtain a relative error independent of intensity we must 'count' the same number of electrons for each measurement. This then implies that dark points will require an inordinate amount of time for measurement. A mechanism must be provided for ignoring points darker than a given level at an early stage. The programmer has two parameters available to control these two features:

1. Signal to noise ratio: a parameter which may be 0, 1, 2 or 3 indicating a relative error of 1/8, 1/16, 1/32 and 1/64 respectively (nominal). See Tab 1 for effective number of photo-electrons counted at each setting.
2. Dim cut off level: a parameter which may be 0, 1, 2 ... 7 indicating a cut off at  $2^{-8}$ ,  $2^{-7}$ ,  $2^{-6}$ , ...  $2^{-1}$  off the maximum permissible intensity (nominal). See Tab 2 for further details.

A highly schematic diagram of some parts of the video processor (Fig 1) will illustrate the operation in more detail. The variable pulse frequency generator at the bottom of the diagram is used to allow measurements of intensities differing by more than the normal 64 to 1 dynamic range of the video-processor and also allows a reference signal to eliminate the effects of light-source intensity variations. The number read by the computer is in effect the ratio of the intensity measured on the photo-cathode and some

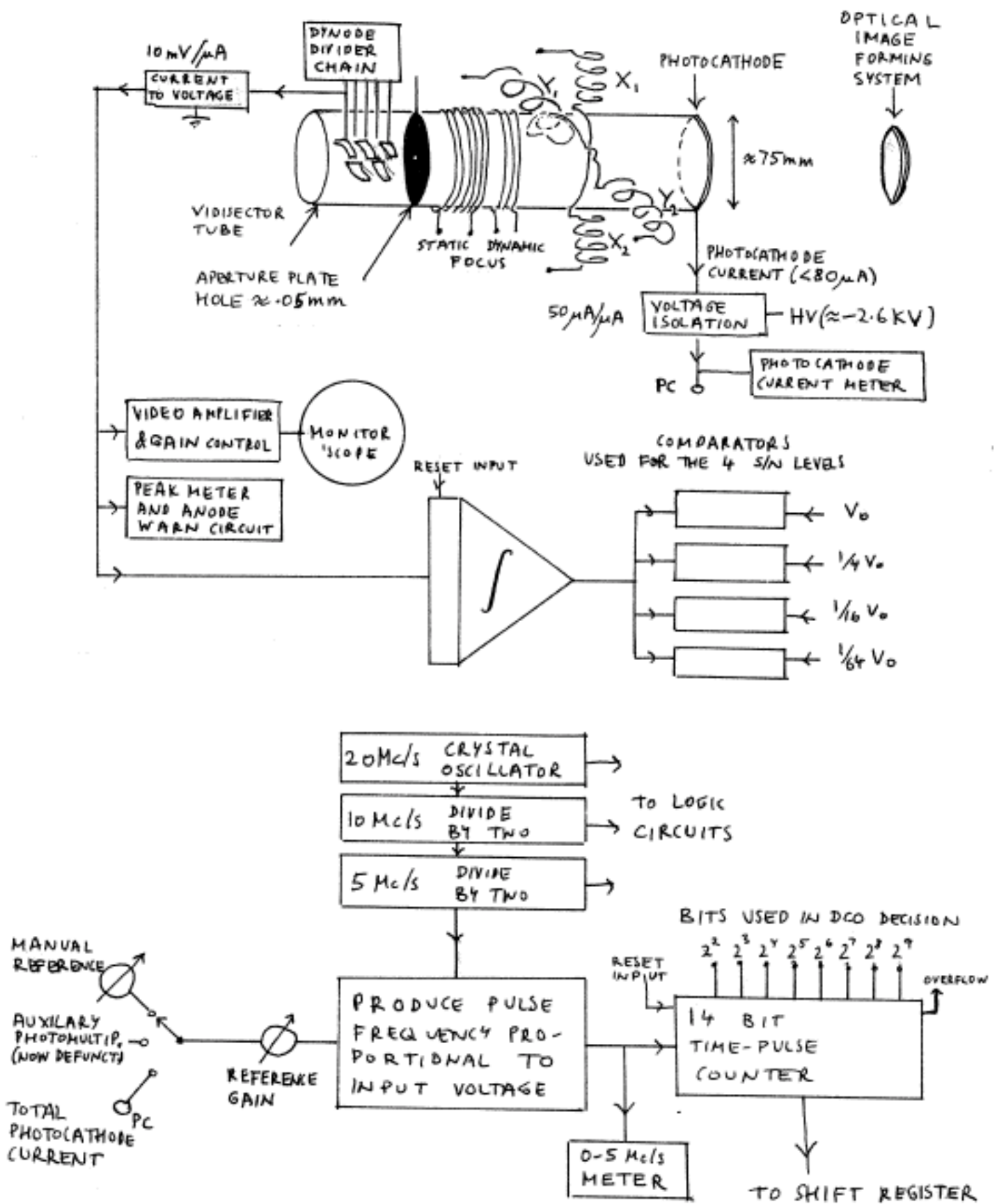

Fig 1

reference signal which may be selected to be the total photocathode current. In this case a change in the illumination will cause an equal change in the two factors used in the ratio and the output of the video-processor will be independent of such changes (unless they are too large).

The variable pulse frequency generator operates by selecting as many pulses as needed from a 5 Mc/s pulse source. The average frequency can be read on a meter which is 5 Mc/s full scale. These pulses are fed into a 14 bit counter when measurements are being taken.

At the same time the output of the electron-multiplier is fed into an integrator whose output is attached to four comparators. These comparators fire when the integrator output reaches a voltage corresponding to  $2^7$ ,  $2^9$ ,  $2^{11}$ ,  $2^{15}$  photoelectrons through the aperture plate (nominally). These four comparators are used for the four different signal to noise ratios, while the  $2^2$ ,  $2^3$ , ...  $2^9$  bits in the time-pulse counter are used in the dim-cut-off decisions.

Fig 2 illustrates this in more detail. Note that both scales are  $\log_2$ . Trace A shows the voltage at the output of the integrator versus the count in the time pulse counter for a very bright point. Small crosses indicate the times at which the comparators at the output of the integrator fire. Small boxes indicate the times when the flip-flops attached to the various bits in the time pulse counter fire. Suppose we had selected a signal-to-noise ratio 2 and a dim-cut-off level 5. At point X (when the appropriate bit comes on in the time pulse counter) a test is made whether

Fig 2

CFL = SIGNAL TO NOISE LEVEL      DCL = DIM CUT OFF LEVEL

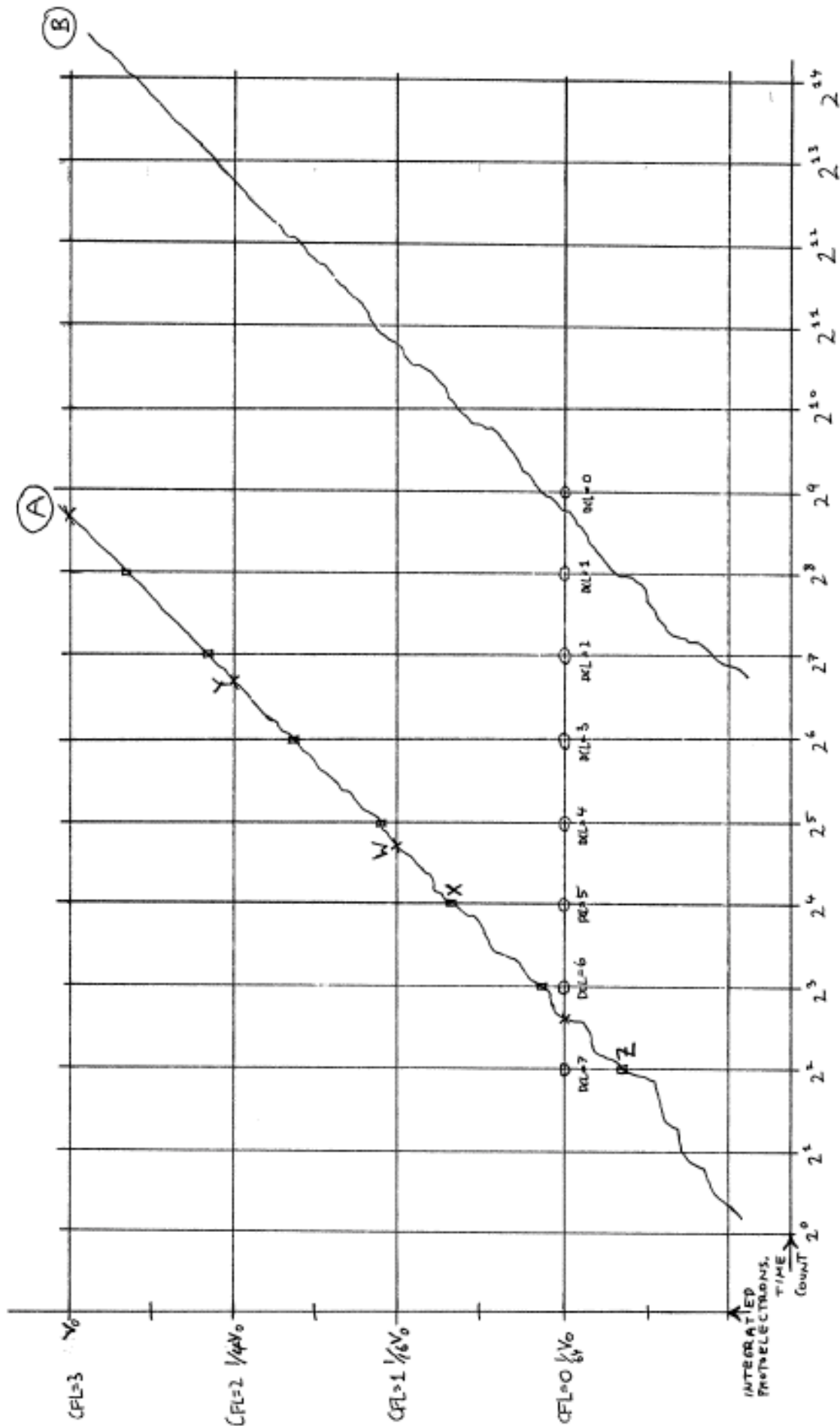



the voltage in the integrator exceeds the  $1/64 V_0$  level. In our case it does and the point is not dim-cut-off. If we had used dim cut off level 7 the test would have been made at point Z and the processing stopped, the integrator and the counter reset and a dim-cut-off value returned to the PDP-6. In our case integration would have proceeded up to point Y where the voltage level corresponding to our selected signal to noise ratio was reached. The significant value now is the count in the time pulse counter. Note however that to obtain the same output for different choices of signal to noise ratios we need to divide by 4 for every increase in signal to noise ratio of 1. So we divide by 16. (If we had used a signal to noise ratio of 1, integration would have stopped at W and we would divide by 4)

To produce the floating point number required for transmission to the PDP-6 the 14 bit binary number is moved from the counter to a shift register when the selected comparator has fired. It is then shifted left until a one appears in the most significant place (ie. it is normalised), the number of shifts is subtracted from the initial exponent. The initial exponent is preset by the selection of signal-to-noise ratio to simulate the division by powers of 4 described above. In this way a four bit exponent (0 to  $17_8$ ) and a six bit mantissa (00 to  $77_8$ ) is retained. Presently exponents larger than 13 cannot occur. When the lin/log switch on the video-processor is in the lin position the right hand half word contains just this floating binary number - written together it ranges from 0 to  $1300_8$ .

To facilitate using this number in the PDP-6 it is reproduced in standard format (ie. preceded by a 2 and with the leading bit in the mantissa) in the left half.

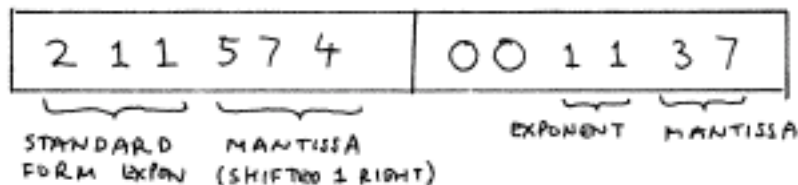

This floating point number can thus range from 0.5 to 1024.0 (0-1300 in the right half).

For many purposes it is more meaningful to work with the logarithm of the incident intensity. When the lin/log switch is in the log position the last six bits are modified such that the right half is a 10 bit value of  $100_8 \cdot \log_2 I$  (since the same flip-flops are used to supply the left half word bits, these too are modified and the left half is now meaningless - actually only the last 3 bits are effected so for some purposes it could still be considered a useful value). The method used to change the value to log base 2 is to leave the exponent unchanged and to feed the mantissa into a table-look up network which finds a three bit correction to be added. This correction is always less than or equal to 5. The relation between the value obtained this way, J, and the value obtained in the left-half with the switch in the lin position, I, is:

$$I = 2^{\frac{J}{100} - 1}$$

Thus  $700_8$  corresponds to 64.0 .

When processing is stopped because of a dim cut off, the DCF (2 bit in the left half word) is set and the value returned to the computer is that produced from the preloaded exponent (ie. it varies with signal to noise ratio and not with dim-cut-off level). The value at which the vidi-sector will just dim-cut-off an intensity on the other hand varies in just the opposite way and the system<sup>(ITS)</sup> does in fact substitute the appropriate number dependent on the selected dim-cut-off. Furthermore it is possible to obtain occasionally a value past this point because of the statistical nature of the signal - ie. at the time the dim-cut-off decision was made it appeared that the point was bright enough (remember that it has only been measured with a signal to noise ratio 0 at this stage) and was on more accurate measurement (ie. this cannot happen when one is using signal to noise ratio 0) found to be darker. Such a value is also replaced by the system<sup>(ITS)</sup> with the exact value where dim-cut-off should have occurred. See Fig 3 for a summary of some of these facts.

We have now arrived at a stage where we can consider some of the more intricate interactions. Firstly note that it is possible for the time pulse counter to overflow. This will happen when we are using a very low dim-cut-off setting (0 for example), a high signal-to-noise ratio (3 for example) and are measuring a point dark enough to be near dim-cut-off (a value near 1300<sub>8</sub>). From Fig 3 it can be seen that it is for this reason that CFL=3 and DCL=0 has much the same effect as CFL=3 and DCL=1. This implies that very dark points cannot be measured with the best signal-to-noise ratio. An overflow will cause both the 2 and the 1 bit in the left half word to be on (actually the system obtains

these bits in another I/O instruction and patches them in). Proceeding with the case CFL=3 and DCL=0 we find that values between 1200 and 1300 (approx.) (Fig 2) will cause both the dim-cut-off and the overflow bits to be on, while points even darker than 1300 will be caught by the dim-cut-off mechanism and have only the dim-cut-off bit on. So one can measure to some extent in this range normally inaccessible to the user of CFL=3 !

The other condition under which overflow is likely to happen is for CFL=2 and DCL=0 where as described above it is possible for a intensity just below the dim-cut-off level to avoid being caught by it now and then because of the noise in this signal yet on more accurate measurement cause the counter to overflow. For most purposes an overflow should be treated just like a dim-cut-off.

The other extreme condition is too small count in the counter. This implies that we have not measured the time accurately enough (and since it is one of the factors in the ratio, it will contribute to the noise). This can only happen when the pulse generator has a very low frequency and we are looking at a very bright point (one almost bright enough to cause an ANODE WARN condition). Also it is extremely unlikely except for the CFL=0 and CFL=1 cases. To deal with this problem the count is tested against 8 for CFL=0 and 16 for CFL=1 and if less, the integration is not stopped, the measurement being taken at a higher signal to noise ratio (actually the tests are also applied in the CFL=2 and 3 cases, but they should not pay off there; if an attempt is made to increment the CFL past 3 an overflow will result).

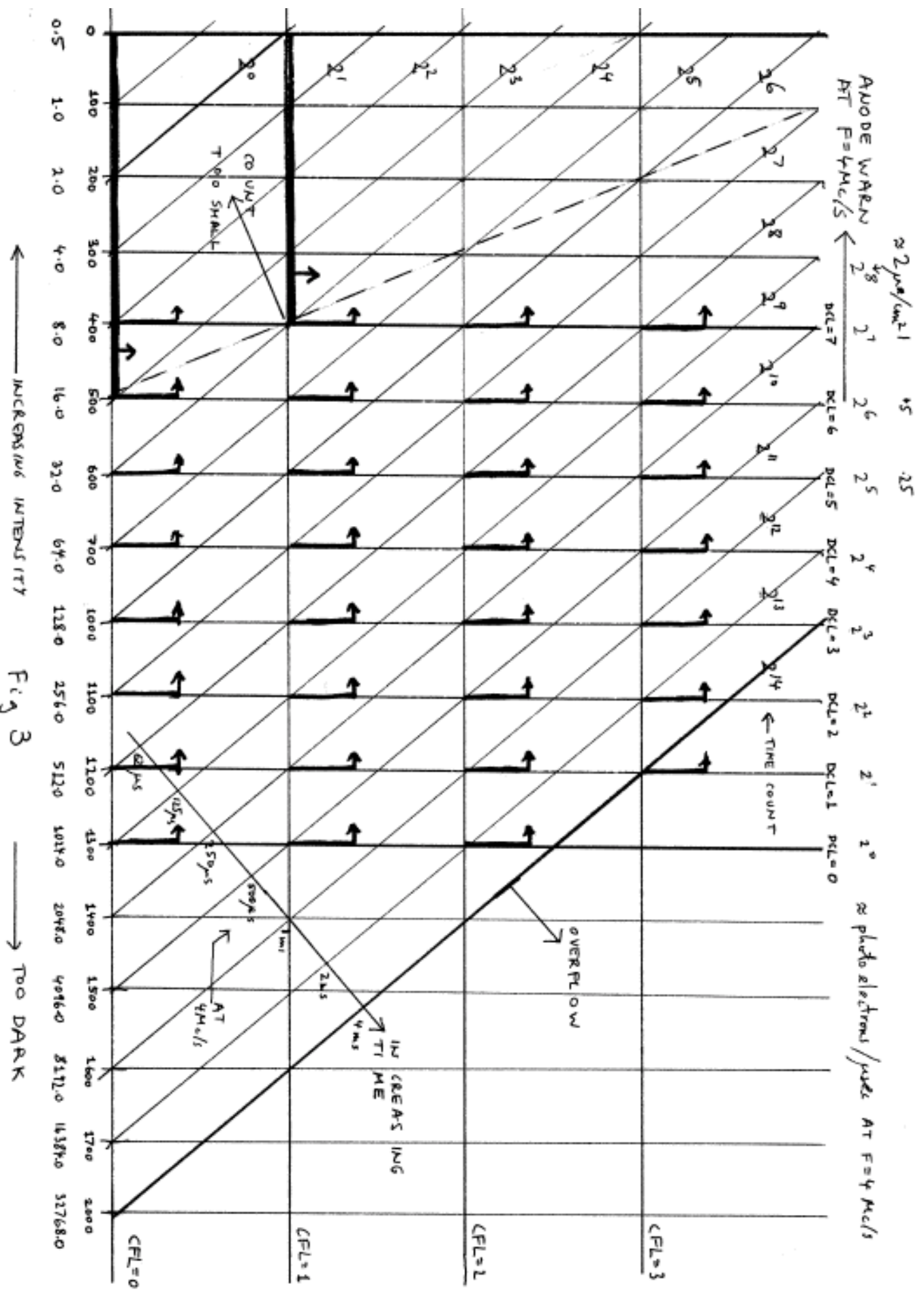

Fig 3

TOO DARK

DIM CUT OFF LEVEL	TIME COUNT	PHOTOELEC/ $\mu$ SEC(NOM.)	SAME FOR F=4 Mc/s	FRACTION OF CUTOFF(F=4 Mc/s)
0	$2^9$	$2^{-2} \cdot F$	$2^0$	$2^{-8}$
1	$2^8$	$2^{-1} \cdot F$	$2^1$	$2^{-7}$
2	$2^7$	$2^0 \cdot F$	$2^2$	$2^{-6}$
3	$2^6$	$2^1 \cdot F$	$2^3$	$2^{-5}$
4	$2^5$	$2^2 \cdot F$	$2^4$	$2^{-4}$
5	$2^4$	$2^3 \cdot F$	$2^5$	$2^{-3}$
6	$2^3$	$2^4 \cdot F$	$2^6$	$2^{-2}$
7	$2^2$	$2^5 \cdot F$	$2^7$	$2^{-1}$

Tab 1

SIGNAL/NOISE LEVEL	EFFECT. PHOTO- ELECTRONS (NOM.)	85 % RANGE (NOMINAL)	99% RANGE (NOMIAL)
0	$2^7$	$\pm 1/8$	$\pm 1/4$
1	$2^9$	$\pm 1/16$	$\pm 1/8$
2	$2^{11}$	$\pm 1/32$	$\pm 1/16$
3	$2^{13}$	$\pm 1/64$	$\pm 1/32$

Tab 2

It is well known that photocathodes suffer temporary 'fatigue' when large current densities flow on them, ie. with the high voltage applied and high incident light. At a somewhat higher current density the damage is permanent. Damage is probably also possible when no voltages are applied and a higher intensity is applied to the photocathode (?). The effect is thought to be thermal and occurs between 1 and  $10 \mu\text{A}/\text{cm}^2$ . For our vidysector the maximum safest current is considered to be  $2 \mu\text{A}/\text{cm}^2$  ( about  $80 \mu\text{A}$  for the whole photocathode when evenly illuminated). A further source of problems exists in the electronmultipl. where too high a gain may damage the last few dynodes, when many electrons travel through the aperture. To protect against both of these misadventures the output of the electronmultiplier (ie. the signal fed into the integrator) is monitored and the high voltage supply is tripped out (ANODE WARN light comes on) when a current flows which nominally corresponds to  $2 \mu\text{A}/\text{cm}^2$ . Naturally this will only protect the whole photocathode if one scans all points on it. (Presently there exist some misadjustments in the system indicating that either the ANODE WARN circuit trips out too early or the gain of the chain photomultiplier - integrator is too low. This may indicate that the effective number of electrons counted at a given signal-to-noise ratio is wrong, thus effecting the measured signal to noise ratio somewhat (the discrepancy is not large here)).

## DISTORTIONS

The X and Y deflection values ( 0-40000<sub>g</sub> ) supplied by the PDP-6 are fed into two 14 bit DAC converters which drive voltage to current convertors. These in turn drive a current which may be several amperes through the horizontal and vertical deflection coils. This current is measured by small series resistors and fed back to allow an accurate relation between the voltage and the current. Because of coupling between the coils and a magnetic shield surrounding them their response is rather slow.

Presently the settling time of the coils is considered to be less than 70 $\mu$ secs and this time is allowed to elapse before the integrator and the time pulse counter are started.

The static focus coil carries an adjustable current and allows the formation of a sharp image on the aperture plate. Because of what one might call curvature of field, accurate focus does not obtain when X and Y deflection currents are applied. Reasonably accurate focus can be restored if a small (-ve) additional focus current proportional to  $X^2 + Y^2$  is applied. This is termed dynamic focusing. The interaction of all of these field and geometric inaccuracies produces distortions in the image which are considerably larger than those found in a typical optical imaging system.

Firstly one would expect some radial distortion proportional to  $X^2 + Y^2$ , (pin-cushion or drum distortion). Further a twist increasing with  $X^2 + Y^2$  (with no



optical system equivalent) will be found. Some errors will depend on X and Y only.

A program has been written to measure the position in address-space of a 10. by 10. grid of points projected on the photocathode. The above errors are present and account for perhaps half of the distortion - the rest is highly unsymmetrical and cannot be so easily explained and parameterised. For this reason a 10. by 10. matrix of X and Y values in address space of these points is stored on DSK; and can be used in interpolation. See Fig 4 for a graphic demonstration of these distortions. Also Fig 5 is a program using these tables.

The photocathode has a non-uniform sensitivity, aside from very local phenomena such as Beeler's craters (about 25 areas of about 0.5 mm diameter with less than half the normal sensitivity). Aside from very small variations over the order of a few mm's this non-uniformity varies smoothly and can thus easily be incorporated in the above 10. by 10. interpolation subroutine. See Fig. 7 for a contour map of the sensitivity of the photocathode alone (measured by closing the iris to 20 mm diameter, removing the lens, placing a piece of tracing paper in front of the iris and producing a more or less uniform illumination of this tracing paper by placing a large white sheet in front of the EYE). This map correlates well with measurements made in other ways with the lens on and the iris closed down. With the iris fully open, a large number of overlapping constrictions cause serious vignetting and a rapid drop of in system sensitivity towards the edge of the field of view (see Fig 8)

REFLEC SCRIPT 69:06:15 09:21:29  
 DELX=5.4594 DELY=5.4594 XNT=-24.5673 YNT=-24.5673  
 XUD= 188.36\*XD+ -1.01\*YD+8174.7  
 YUD= -3.95\*XD+-211.28\*YD+7655.1

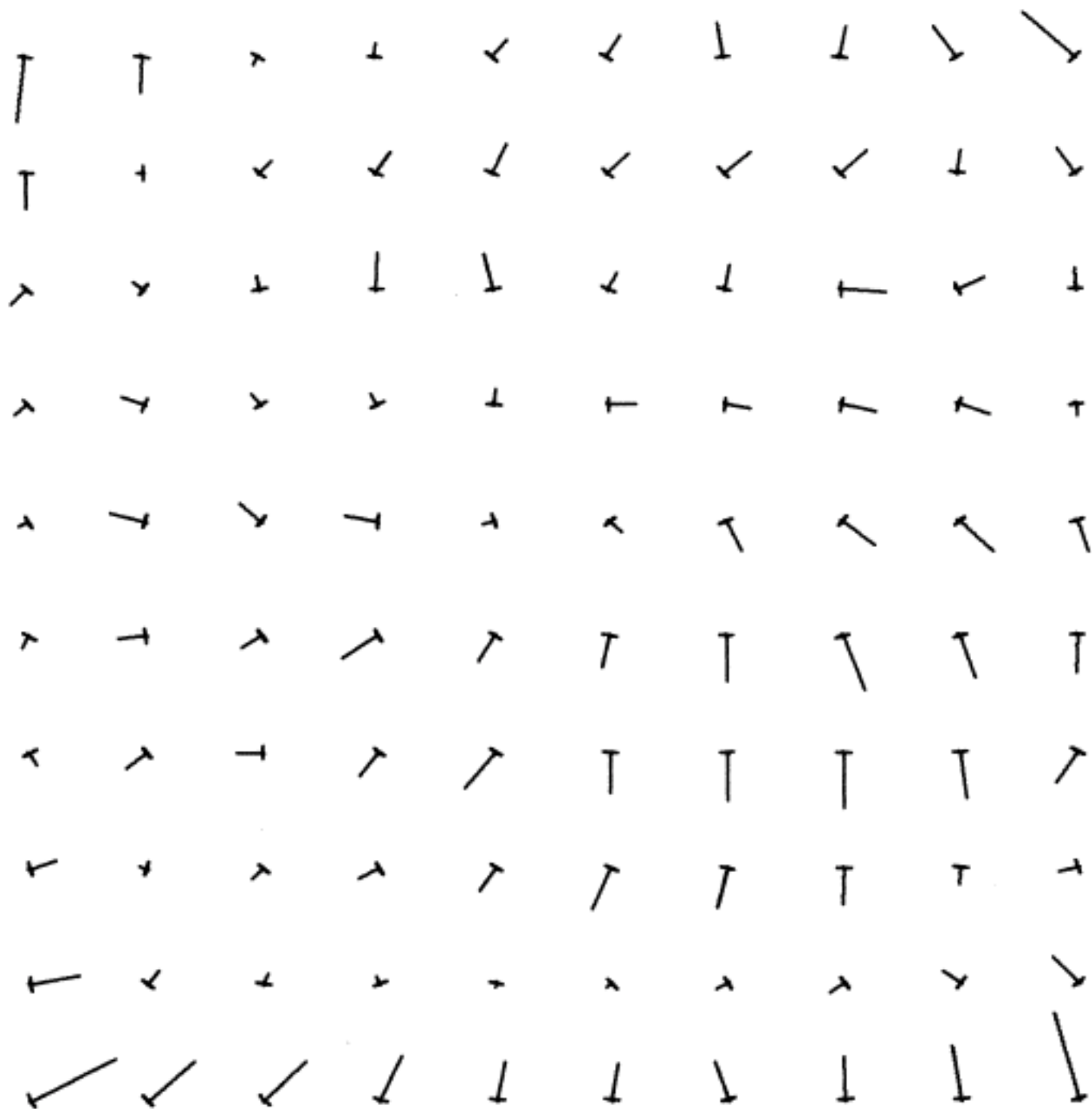

Fig 4 ARROWS EXAGGERATED 3 TIMES

INTERPOLATION FROM THE STORED GRID:

Fig 5 contains the interpolation formula found when fitting a function  $a_{00} + a_{10}x + a_{01}y + a_{11}xy$  to the values at the four corners of a little elemental square in the grid. The photocathode space is measured in mm's from the approximate centre of the photocathode. Y is measured down to allow a right handed system with Z pointing towards the scene from the EYE. The orientation as shown is that which would appear on the monitor (hence inverted in both X and Y as far as the back of the photocathode is concerned). Convolutions with larger support (rather than the 4 points chosen here) could be used, but little extra accuracy can be expected.

Also available is a least squares linear approximation

$$X = a_x XD + a_{xy} YD + X_0$$

$$Y = a_{yx} XD + a_y YD + Y_0$$

$$a_x \approx 200. \quad a_{xy} \approx a_{yx} \approx 0 \quad a_y \approx -210.$$

$$X_0 \approx 8200. \quad Y_0 \approx 8200.$$

In fact Fig 4 showing the distortion is wrt coordinates found in this way.

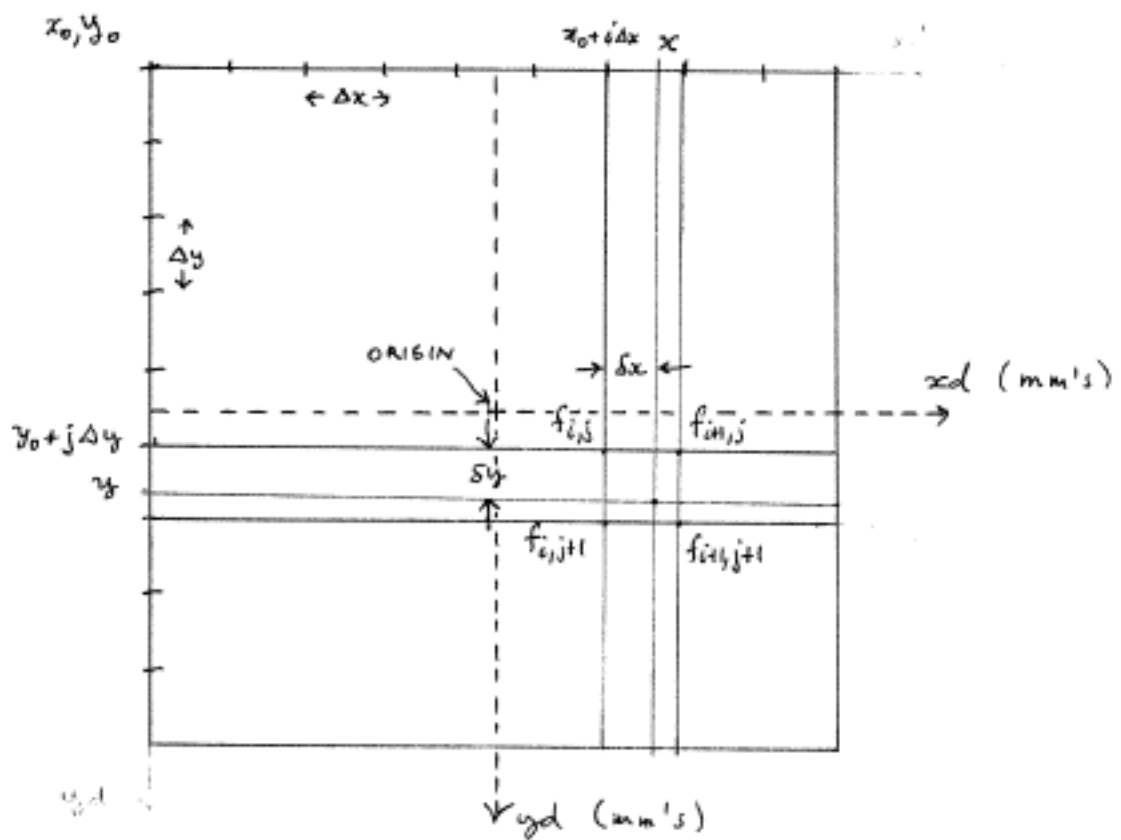

TO ESTIMATE  $f(x,y)$ . WE INTERPOLATE A POLYNOMIAL OF THE FORM:  $a_0 + a_1x + a_2y + a_3xy$

$$\begin{aligned}
 f(x,y) \approx & \left(1 - \frac{s_x}{\Delta x} - \frac{s_y}{\Delta y} + \frac{s_x s_y}{\Delta x \Delta y}\right) f_{i,j} \\
 & + \left(\frac{s_x}{\Delta x} - \frac{s_x s_y}{\Delta x \Delta y}\right) f_{i,j+1} \\
 & + \left(\frac{s_y}{\Delta y} - \frac{s_x s_y}{\Delta x \Delta y}\right) f_{i+1,j} \\
 & + \frac{s_x s_y}{\Delta x \Delta y} f_{i+1,j+1}
 \end{aligned}$$

Fig 5a

## EXPLANATION OF SYMBOLS IN FOLLOWING PROGRAM:

XNT -  $x_0$   
YNT -  $y_0$   
DELX -  $\Delta x$   
DELY -  $\Delta y$   
DMNX -  $S_x / \Delta x$   
DMNY -  $S_y / \Delta y$   
QNI -  $i$   
QNJ -  $j$

SCLX -  $a_x$   
SCLY -  $a_{xy}$   
SCLYX -  $a_{yx}$   
SCLY -  $a_y$

CNTX -  $X_0$   
CNTY -  $Y_0$

INPUT TO GETVID IS  $XX, YY$  IN MM'S.  
OUTPUT FROM -  $XSUM, YSUM$  VID COORDINATES.

THESE ARE FIXED (0-37778) LEFT HALF WORDS  
(AS NEEDED FOR .VSCAN)

OPTGET = 1 → USE LINEAR APPROXIMATION  
= 2 → INTERPOLATION

BAD7 = 0 → BSCL = 1.0  
= 1 → BSCL = SENSITIVITY OF PHOTO CATHODE

Fig 5 b

```

XCORD: BLOCK 10.*10.  #X COORDINATES OF GRID
YCORD: BLOCK 10.*10.  #Y COORDINATES OF GRID
BSCRD: BLOCK 10.*10.  #SENSITIVITY AT GRID POINTS

SCLX: 194.0  #VIDI UNITS PER AD MM
SCLXY: 0.0
SCLYX: 0.0
SCLY: -216.0  #VIDI UNITS PER YD MM

CNTX: 8192.0  #HORIZ CENTRE OF VIDI
CNIY: 8192.0  #VERTIC CENTRE OF VIDI

DELX: 5.5037190  #HORIZONTAL SPACING OF GRID IN MM'S
DELY: 5.5037190  #VERTICAL SPACING OF GRID IN MM'S
XNT: -24.767063  #CORNER X COORDINATE OF GRID
YNT: -24.767063  #CORNER Y COORDINATE OF GRID

NNX: 10.  #NUMBER OF POINTS HORIZONTALLY IN GRID
NNY: 10.  #NUMBER OF POINTS VERTICALLY IN GRID
OPTGET: 1  # 1-> LINEAR TRANSFORMATION, 2-> INTERPOLATION
BADJ: 0  #NON-ZERO TO REQUEST ADJUST OF SENSITIVE

```

APPROXIMATE VALUES

---

```

PHIDAT: BLOCK 20.*20.  #REFLECTIVITY DATA
NPH: 20  #SIZE OF THIS MATRIX

F: 330.0  #EXIT PUPIL TO PHOTOCATHODE DISTANCE
FCLN: 254.0  #FOCAL LENGTH

XSLIM: 100.0  #TETHER ON XS
LAMLM: 80.0  #DRAGSTER LIMIT ON LAMBDA
0

ADRO2: 0  #AD*RI0*2
DCYSTV: 1000.0  #DCF STANDARD SUBSTITUTE
VERYSM: 0.1  #SMALLEST REASONABLE FRAME SIZE

MIU: 0.65  #CONTRACTION FACTOR
LARDIM: 30.0  #MAXIMUM RADIUS OF IMAGE SPACE
REDLIM: 0.5  #REDUCTION LIMIT

OPTION: 1  #DIVISION OPTION

XCENTR: 0  #X OF CENTRE OF IMAGE OF SPHERE
YCENTR: 0  #Y OF CENTRE OF IMAGE OF SPHERE

XNORTH: 0  #EXTREMETIES
YNORTH: 0
XWEST: 0
YWEST: 0
XSOUTH: 0
YSOUTH: 0
XEAST: 0
YEAST: 0

RAUCIR: 0  #MEASURED RADIUS ON PHOTOCATH
RHO: 0  #CALCULATED TRUE RADIUS IN 3-D
CMDCF: 0  #VALUE GIVEN TO DIM POINTS

```

↓ IGNORE

DATIOB: XCORD-...XCORD #10 POINTS

```

WRTDAT: .OPEN DATCN,DATOPN      .WRITE OUT MEMORY
        .VALUE
        MOVE R1,DATI08
        .IOT DATCN,R1
        .CLOSE DATCN,
        R

```

```

REDDAT: .OPEN DATCN,DATIPN      .READ IN MEMORY
        .VALUE
        MOVE R1,DATI08
        .IOT DATCN,R1
        .CLOSE DATCN,
        R

```

```

GETVID: S2 EDGFLG*              ;INITIALIES HIT EDGE FLAG
;F      BSCL=1.0
        M R7,DPGET              ;CALCULATE VIDI COORDINATES
        J .(R7)                 ;SELECT INTERPOLATION OPTION
        SKIPA
        J CMPCRD

```

```

SIMCRD: ;GET COORDINATES THE GOOD OLD WAY
;F      XSUM=XX*SCLX+YY*SCLY+CNIX
        JUMPGE R1,NUDIFC
        S2 XSUM                  ;TOO FAR LEFT
        J NUDIFB

```

```

NUDIFC: CAMG R1,(16383.0)
        J NUDIFA

```

```

;F      XSUM=16383.0
NUDIFB: S0 EDGFLG              ;MARK THAT WE WENT OVER EDGE
NUDIFA:

```

```

;F      YSUM=XX*SCLYX+YY*SCLY+CNIX
        JUMPGE R1,NEDIFC
        S2 YSUM                  ;TOO FAR DOWN
        J NEDIFB

```

```

NEDIFC: CAMG R1,(16383.0)
        J NEDIFA

```

```

;F      YSUM=16383.0
NEDIFB: S0 EDGFLG              ;MARK THAT WE WENT OVER EDGE
NEDIFA: SKIPN EDGFLG
        J LAMB

```

```

;      RECALCULATE XX,YY IN CASE OF EDGE PROBLEMS

```

```

;F      DELT=SCLX*SCLY-SCLXY*SCLYX
;F      XX=((XSUM-CNTX)*SCLY-(YSUM-CNTY)*SCLXY)/DELT
;F      YY=-((XSUM-CNTX)*SCLYX-(YSUM-CNTY)*SCLX)/DELT
        SKIPA

```

```

LAMB:   A (P)

```

```

;      FIX AND PUT IN LEFT HALF WORD

```

```

;I      XSUM=FIX<XSUM>*1000000

```

```

;I      YSUM=FIX<YSUM>*1000000

```

```

R

```

LINEAR

TRANSFORMATION

```

CALCOX:
  IF      DMNX'=-FLOAT<QNI'='FIX<IZIP'=(XX'-XNT)/DELX>>+IZIP
          R

CALCOY:
  IF      DMNY'=-FLOAT<QNJ'='FIX<JZIP'=(YY'-YNT)/DELY>>+JZIP
          R

CMPORD:  SZ EDGFLG          ;COMPUTE INTERPOLATED COORDINATE
          Q CALCOX          ;CALCULATE DMNX,IZIP
          Q CALCOY          ;CALCULATE DMNY,JZIP

          SKIPL R1,IZIP     ;DID WE HIT EDGE ON LEFT
          J NONIOK

  IF      XX=XNT
          J NPNAAB

NONIOK:  M R1,QNI
          A K1
          CAMGE R1,NNX     ;DID WE HIT EDGE ON THE RIGHT
          J NPNIOK

  IF      XX=XNT+9.0*DELX-.01
NPNAAB:  SQ EDGFLG          ;MARK EDGE PROBLEMS
          Q CALCOX          ;RECALCULATE SOME

NPNIOK:  SKIPL R1,JZIP     ;DID WE HIT TOP EDGE
          J NONJOK

  IF      YY=YNT
          J NONAAA

NONJOK:  M R1,QNJ
          A R1
          CAMGE R1,NNY     ;DID WE HIT BOTTOM EDGE
          J NPNJOK

  IF      YY=YNT+9.0*DELY-.01
NONAAA:  SQ EDGFLG          ;MARK EDGE PROBLEMS
          Q CALCOY          ;RECALCULATE SOME

NPNJOK:  SUBS R5,NNX,QNJ,QNI
          M R4,R5          ;GENERATE POINTERS INTO ARRAYS
          ADD R4,NNX

          ; GENERATE COEFFICIENTS
  IF      COF1'=1.0-DMNX-DMNY+COF4'='DMNX+DMNY
  IF      COF3'='DMNX-COF4
  IF      COF2'='DMNY-COF4

          ; INTERPOLATE
  IF      XSUM'='FIX<COF1*XCORD(R5)+COF2*XCORD(R4) $
          +COF3*XCORD(R5+1)+COF4*XCORD(R4+1)>
  IF      YSUM'='FIX<COF1*YCORD(R5)+COF2*YCORD(R4) $
          +COF3*YCORD(R5+1)+COF4*YCORD(R4+1)>
          SKIPN BADJ
          J NOBADJ

  IF      BSCL'='COF1+3SCRD(R5)+COF2+3SCRD(R4) $
          +COF3+3SCRD(R5+1)+COF4+3SCRD(R4+1)
NOBADJ:  MOVSS XSUM          ;PUT IN LEFT HALF
          MOVSS YSUM          ;PUT IN LEFT HALF
          SKIPN EDGFLG

COMREF:  A (P)
          R

```



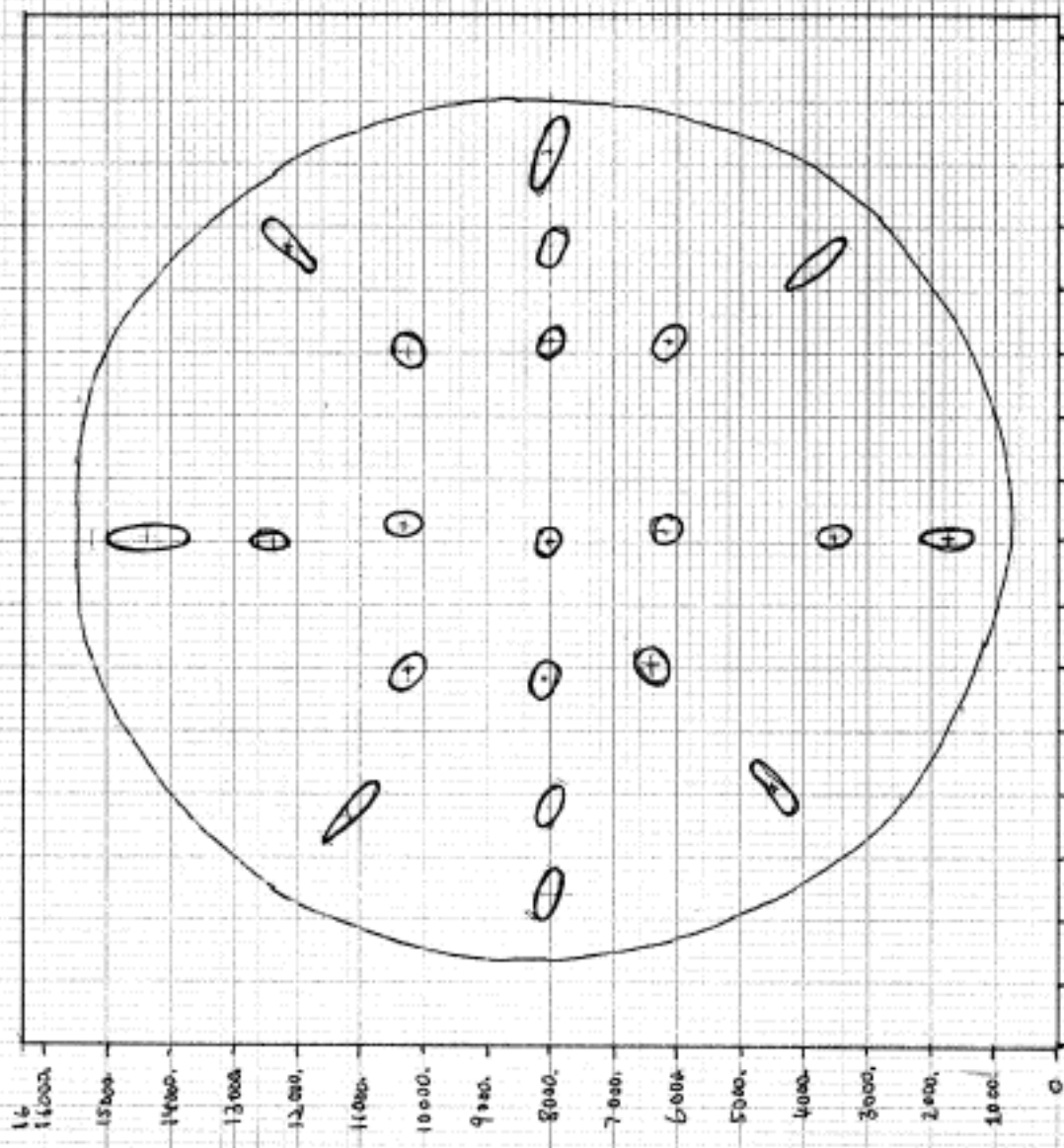

OUTLINE OF SENSITIVE  
AREA OF THE VIBRIECTOR;  
 (10" LENS)  
 AND POINT-SPREADS  
 (10 TIMES EXAGGERATED)  
 HALF-INTENSITY CONTOURS

PARAXIAL: 18mm DIAMETER  
 NEAR EDGE: 18 x .6

Fig 6

0 1000 2000 3000 4000 5000 6000 7000 8000 9000 10000 11000 12000 13000 14000 15000 16000

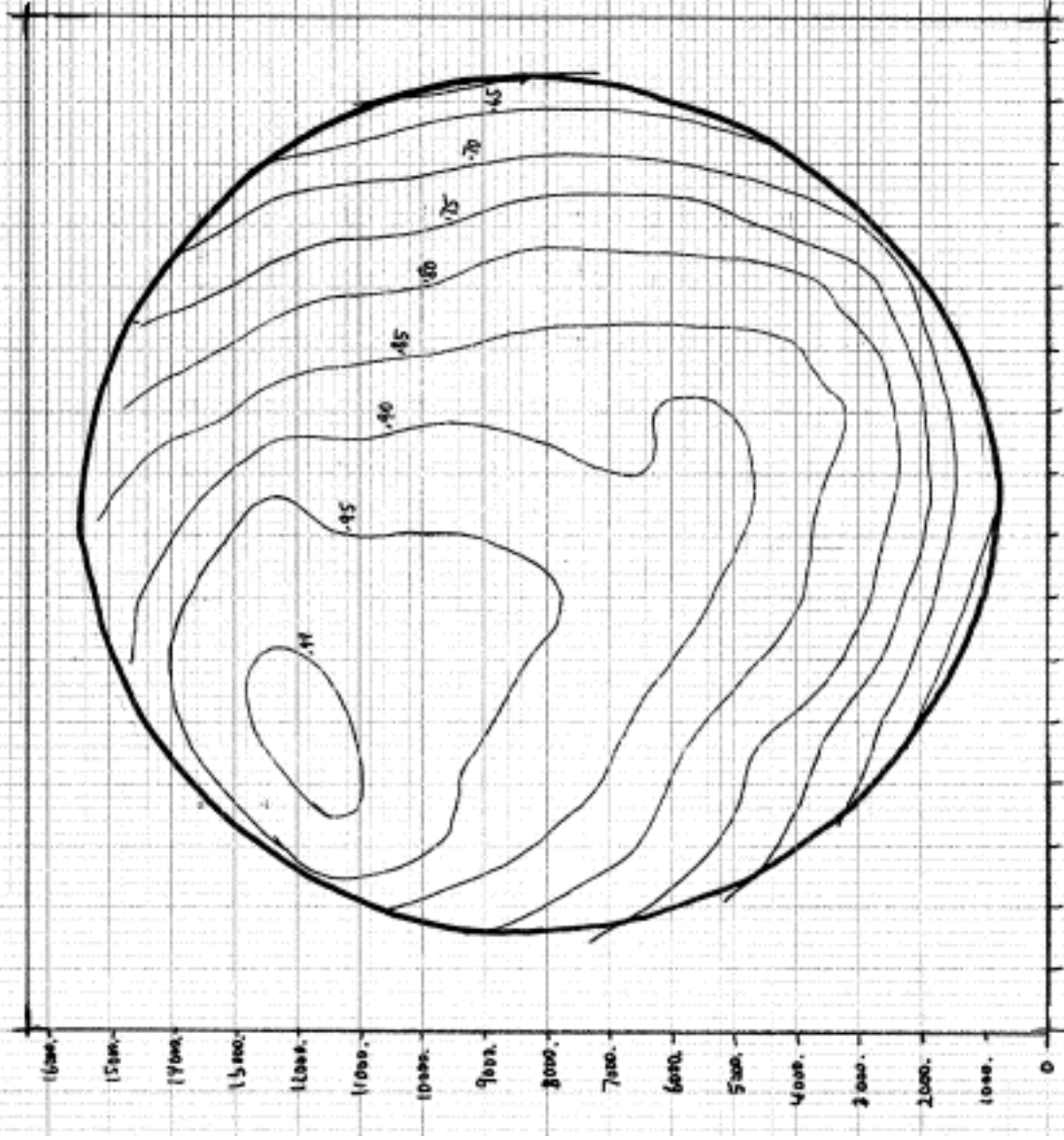

RELATIVE SENSITIVITY OF THE  
PHOTO CATHODE: (NEW VIDEO)  
 COORDINATES ARE 0-16383. (0-40000g)  
 (THE OUTLINE OF THE FIELD OF  
 VIEW IS NOT EXACTLY DRAWN)

Fig 7

0 1000. 2000. 3000. 4000. 5000. 6000. 7000. 8000. 9000. 10000. 11000. 12000. 13000. 14000. 15000. 16000.

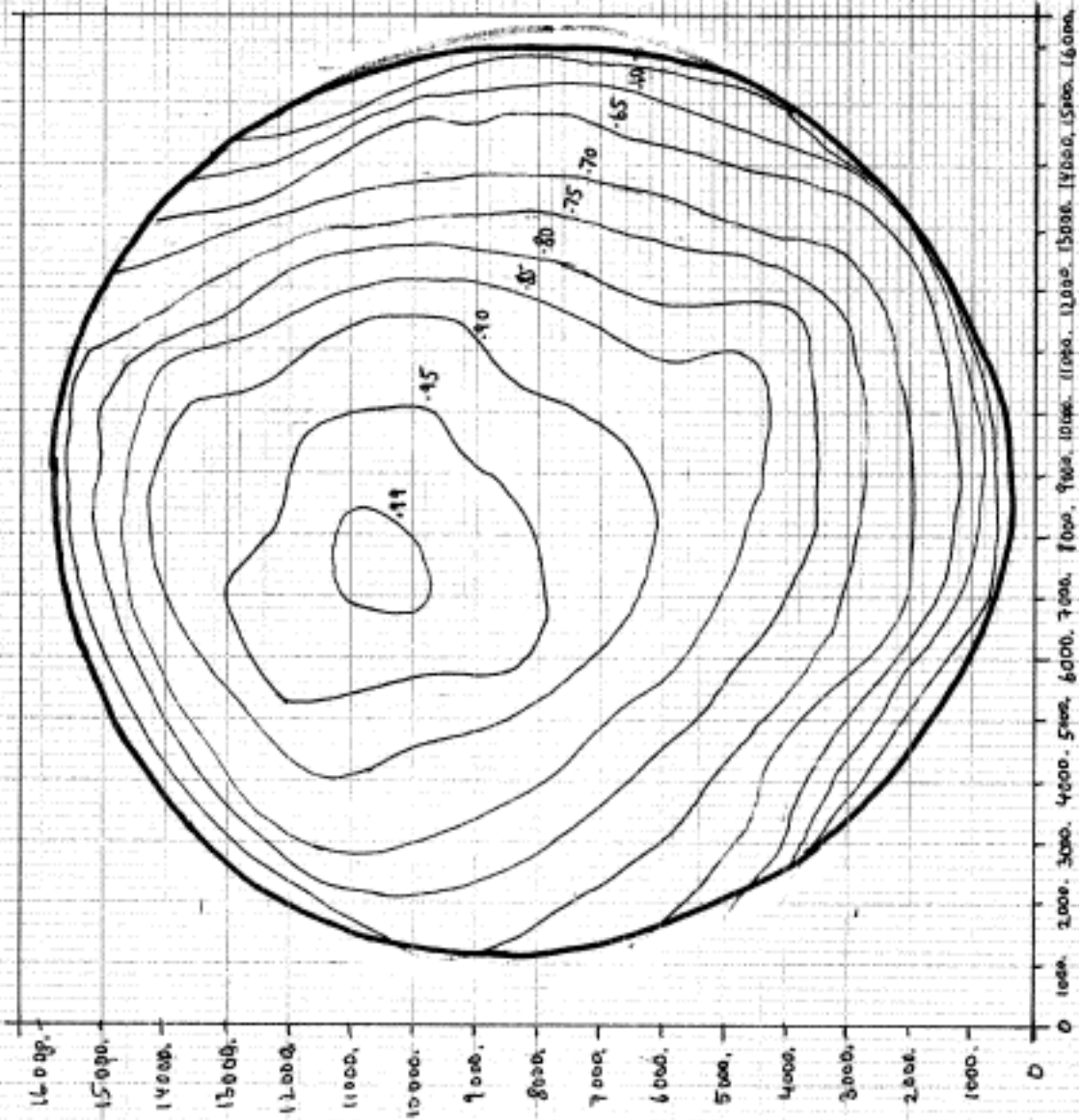

SENSITIVITY OF VIBROJECTOR  
WITH IRIS FULL OPEN:

COORDINATES ARE 0-16183.  
(THE OUTLINE OF THE FIELD  
OF VIEW IS NOT EXACTLY  
DRAWN.)

NEW VIBROJECTOR, 10" LENS

Fig 8



OVERFLOW (EXPONENT)

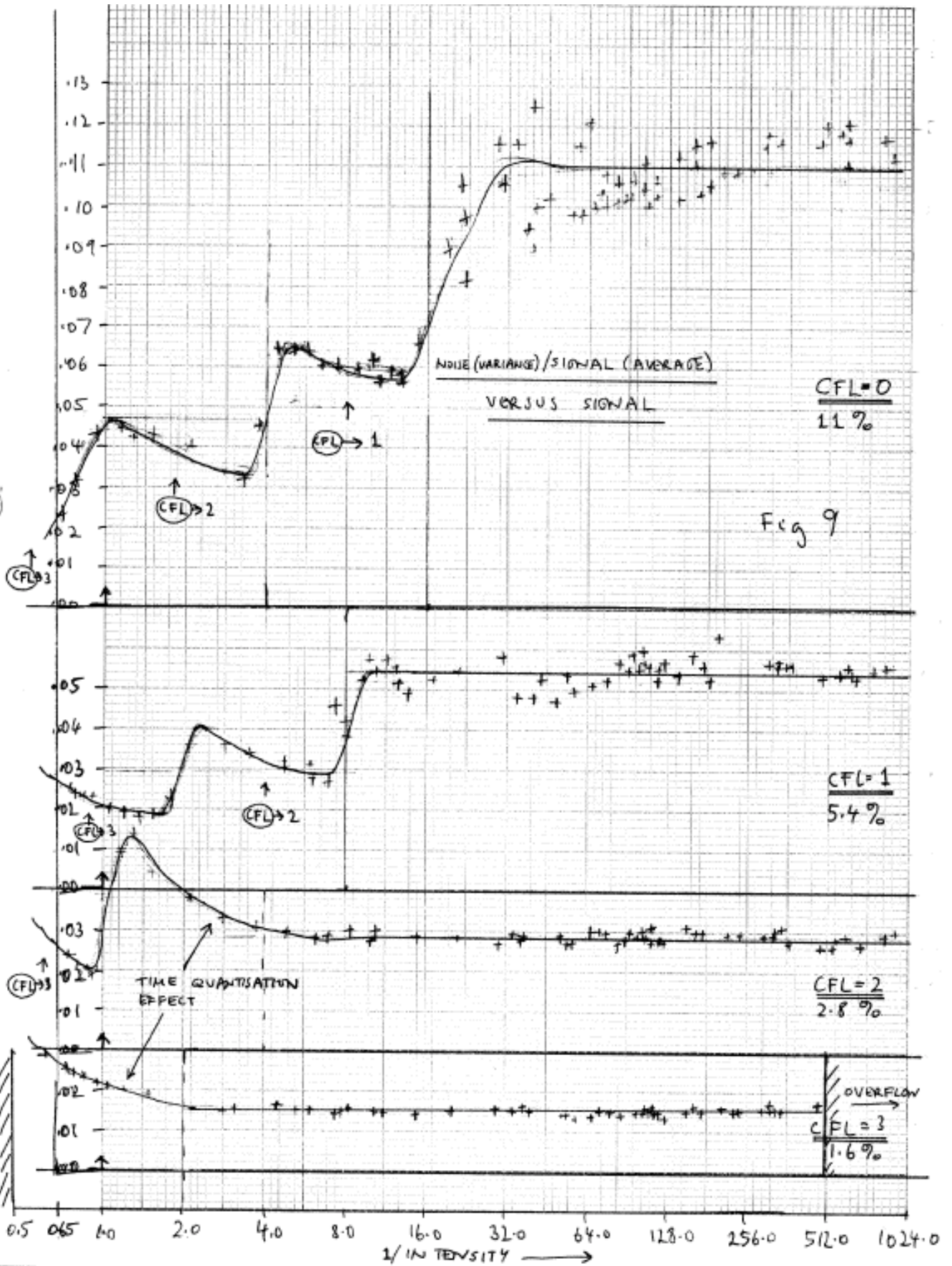
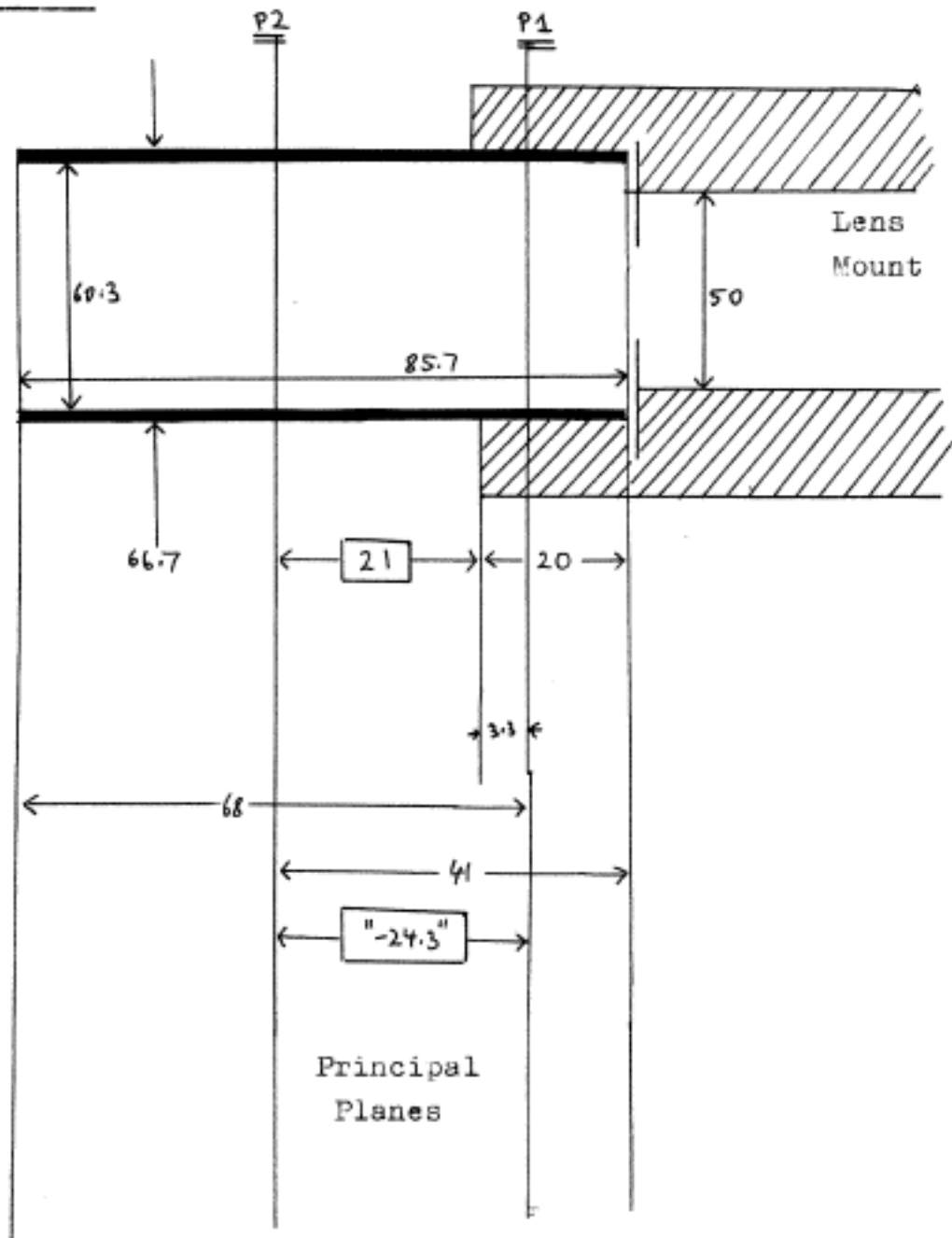

Fig 9

10 " LENS :



FOCAL LENGTH: 254 mm

MAXIMUM F STOP: 5.1

Fig 10

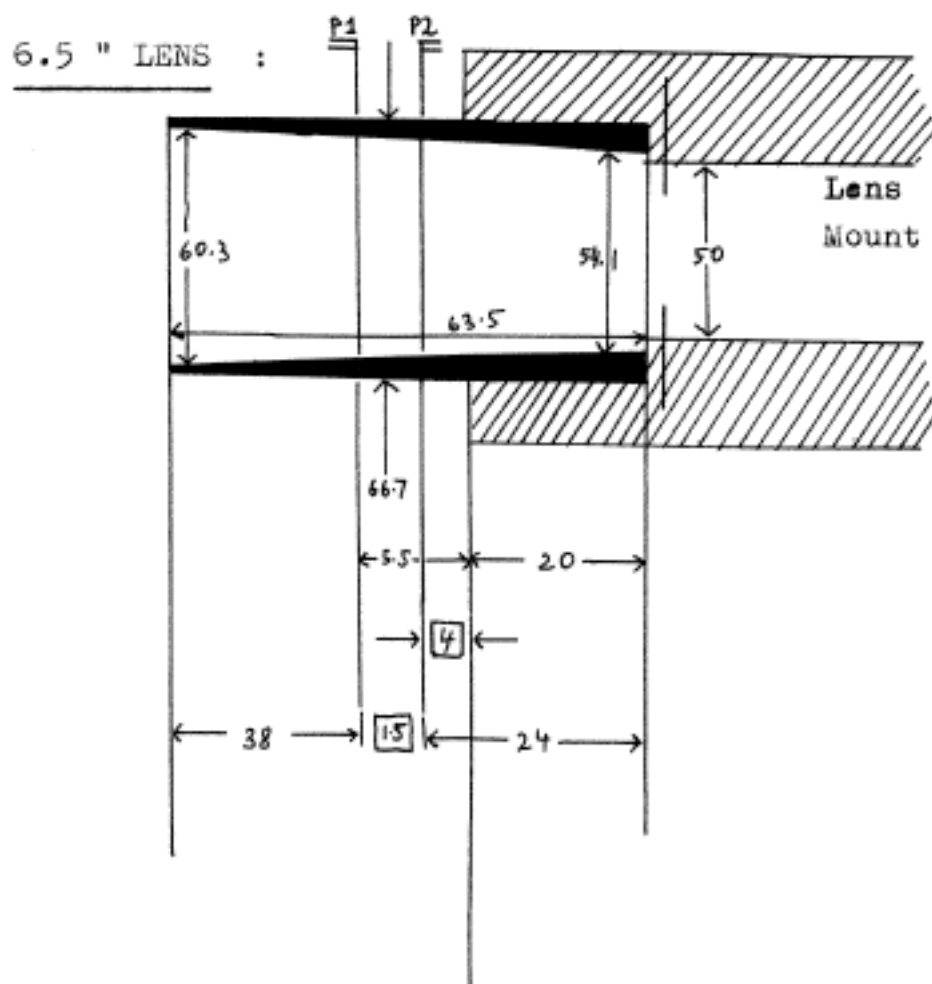

Fig 11

80 mm Hasselblad :

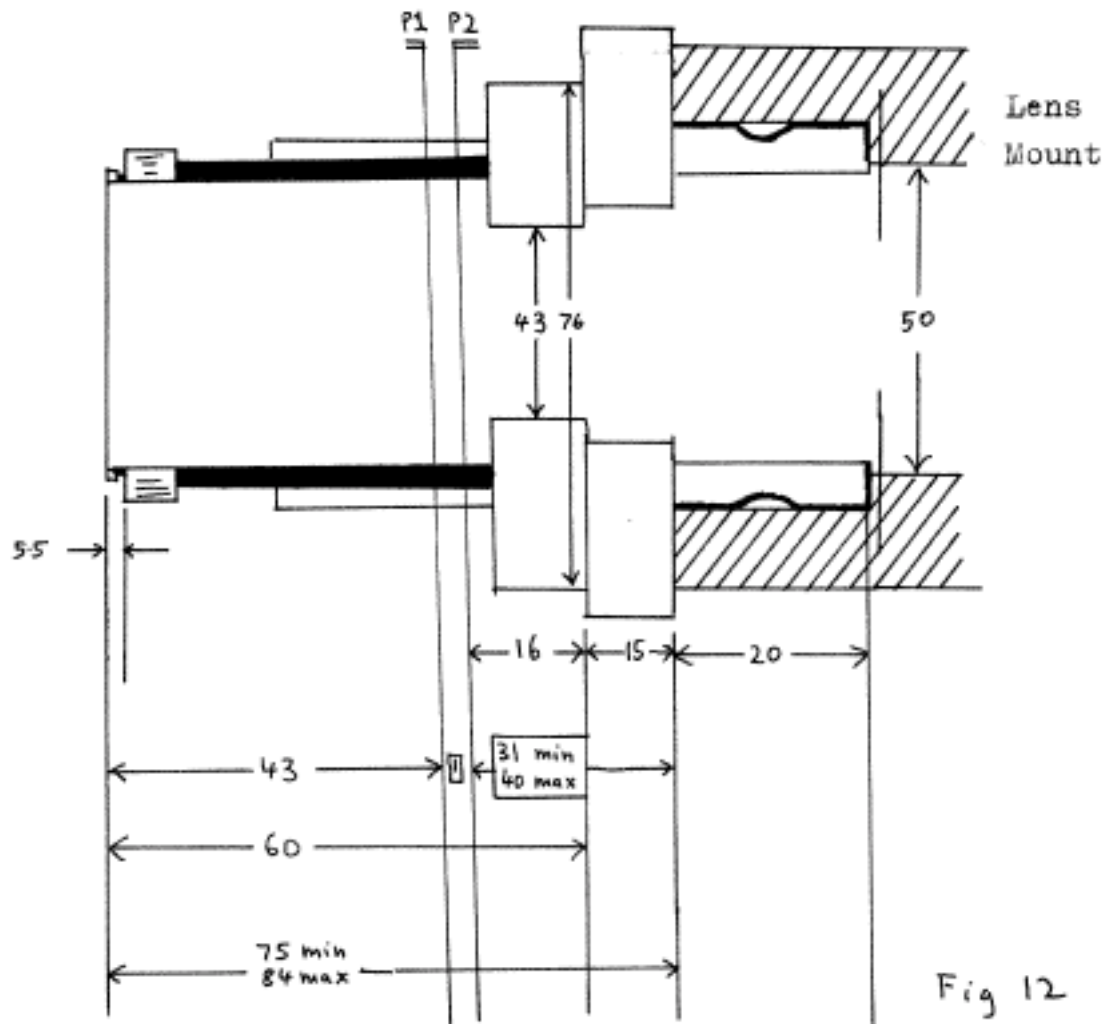
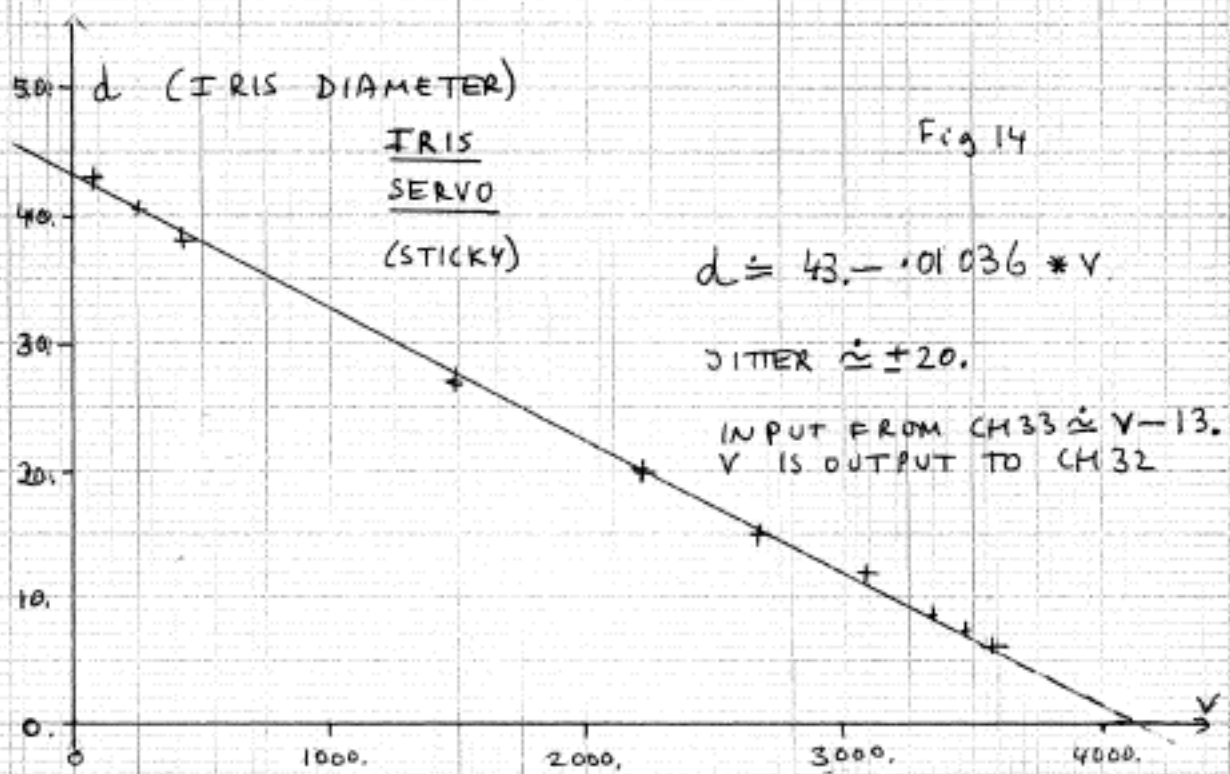
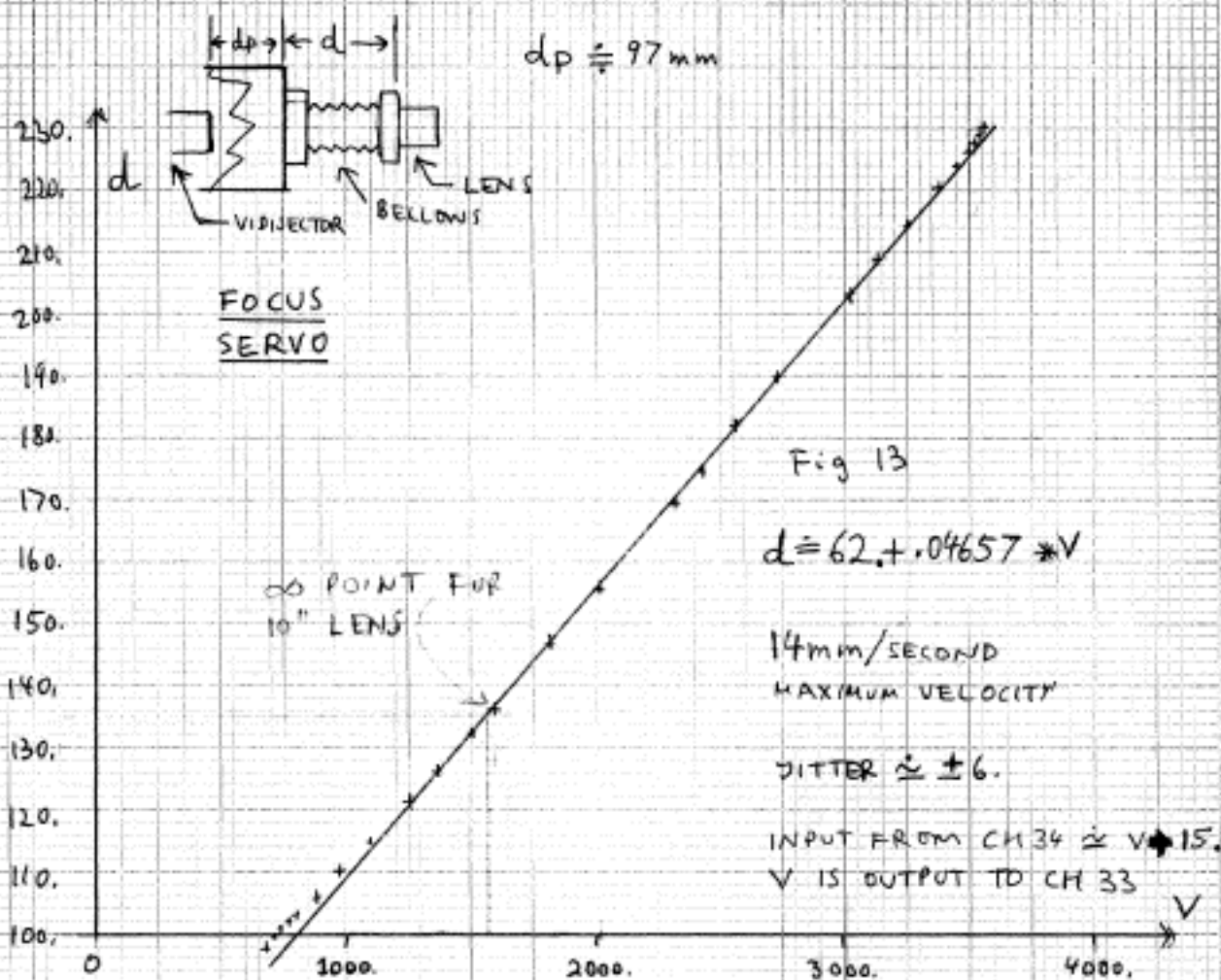

Fig 12

FOCAL LENGTH: 80 mm

MAXIMUM F STOP: 2.8

Note: Open Iris in Lens mount to avoid vignetting.  
A slide adaptor is available for this lens.





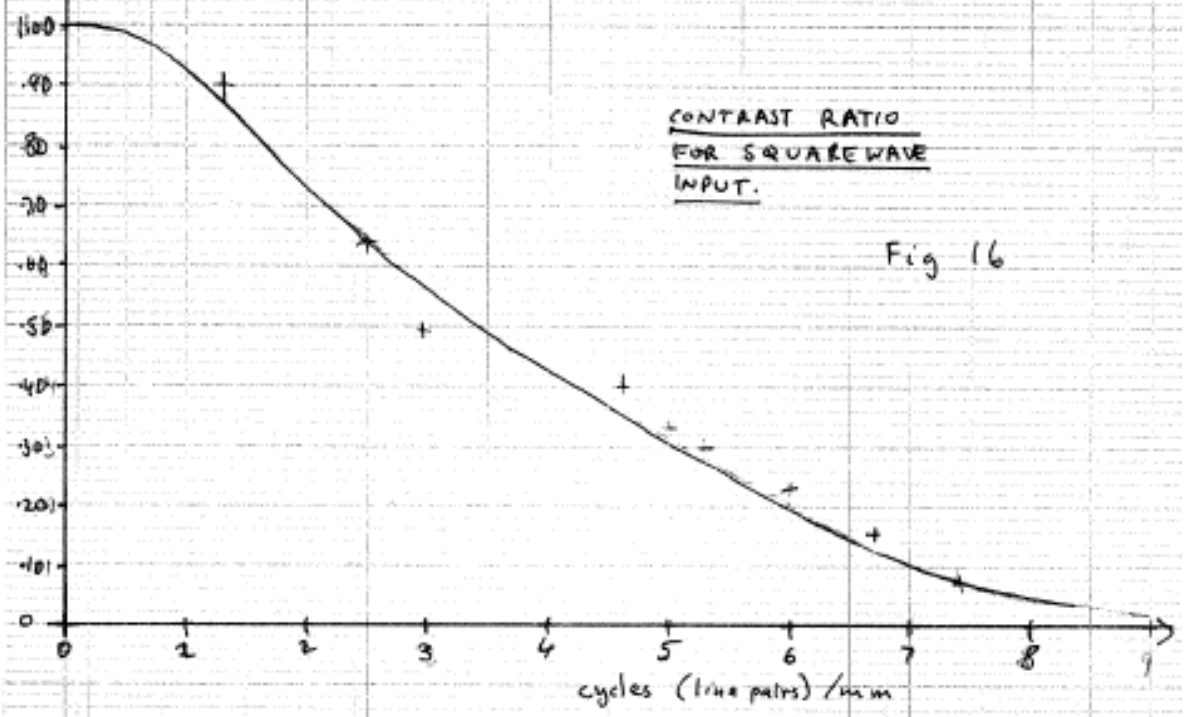
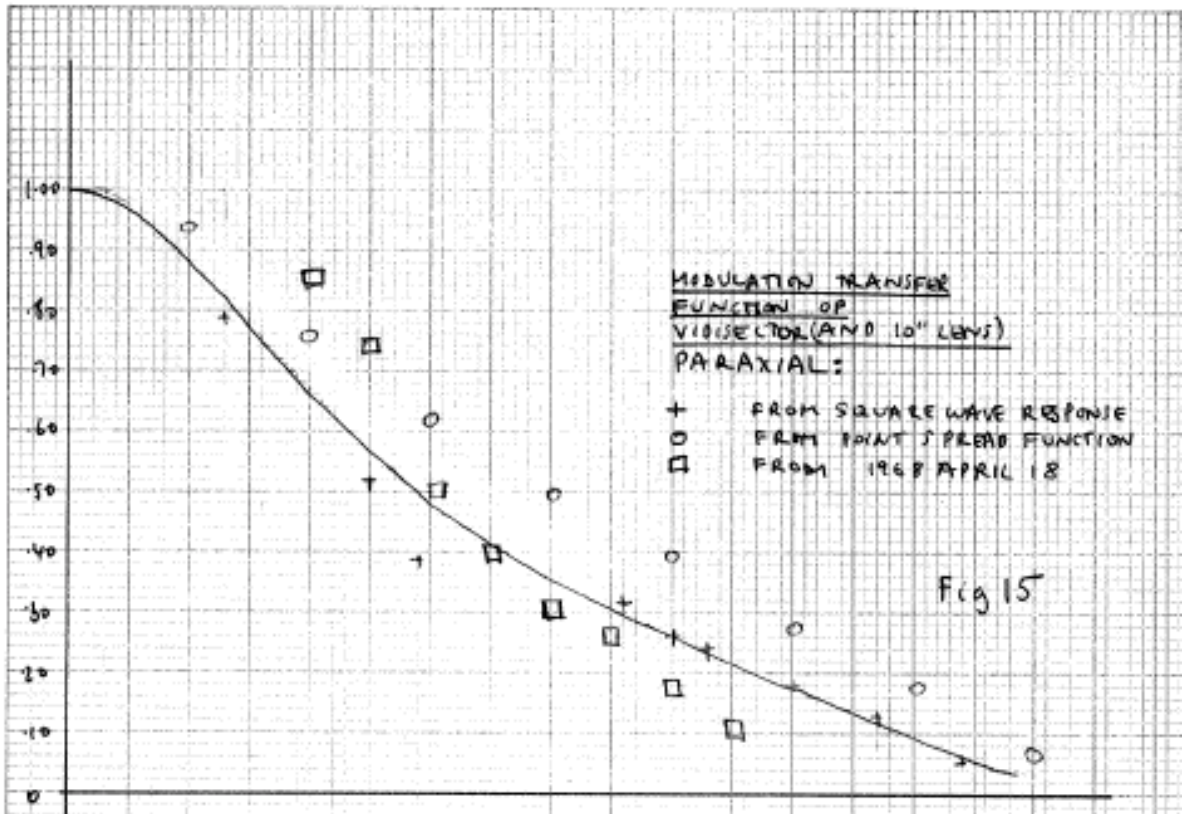

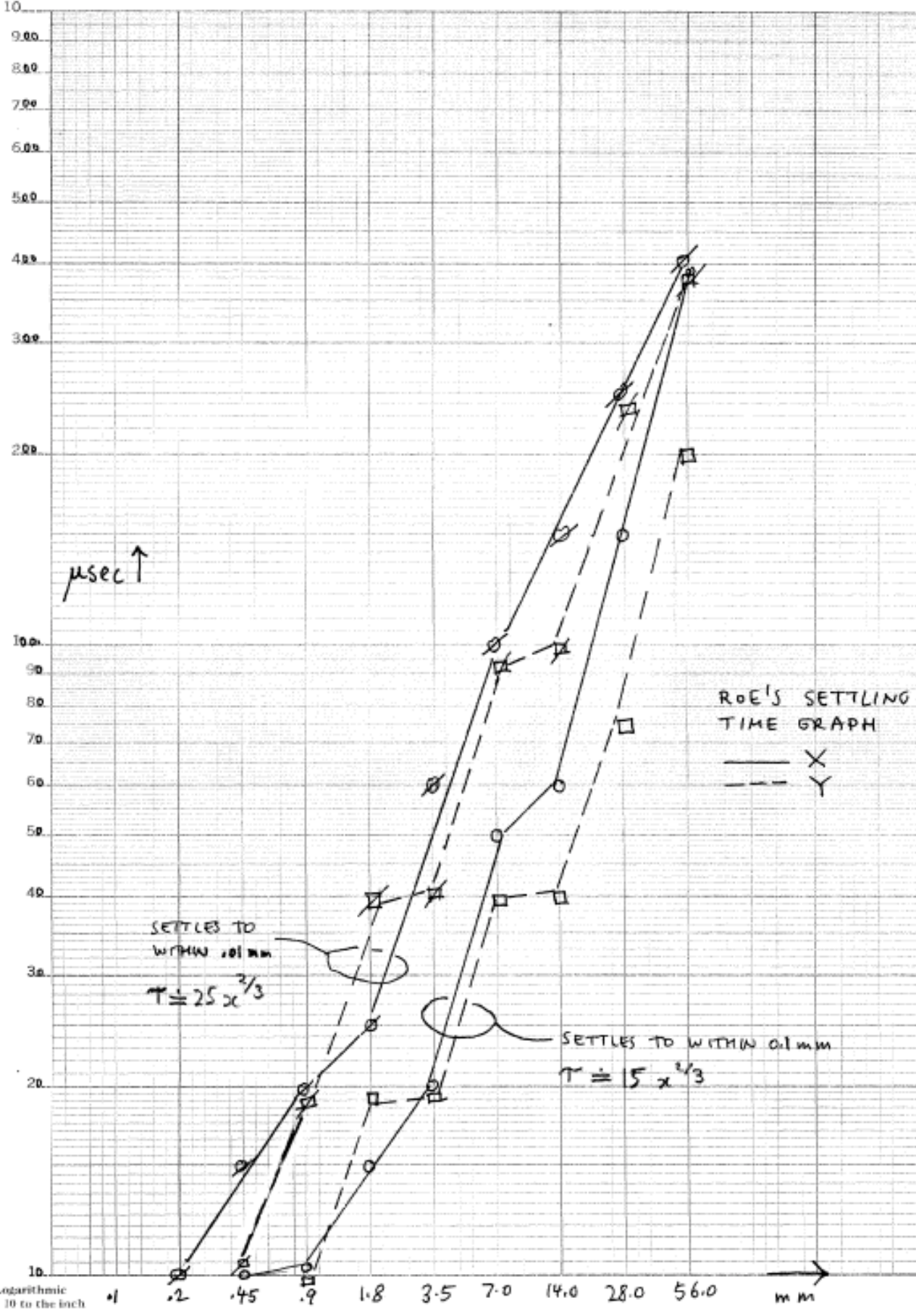

MAP OF BELEK'S CRATER  
ON NEW VIDELECTOR PHOTO-  
CATHODE.

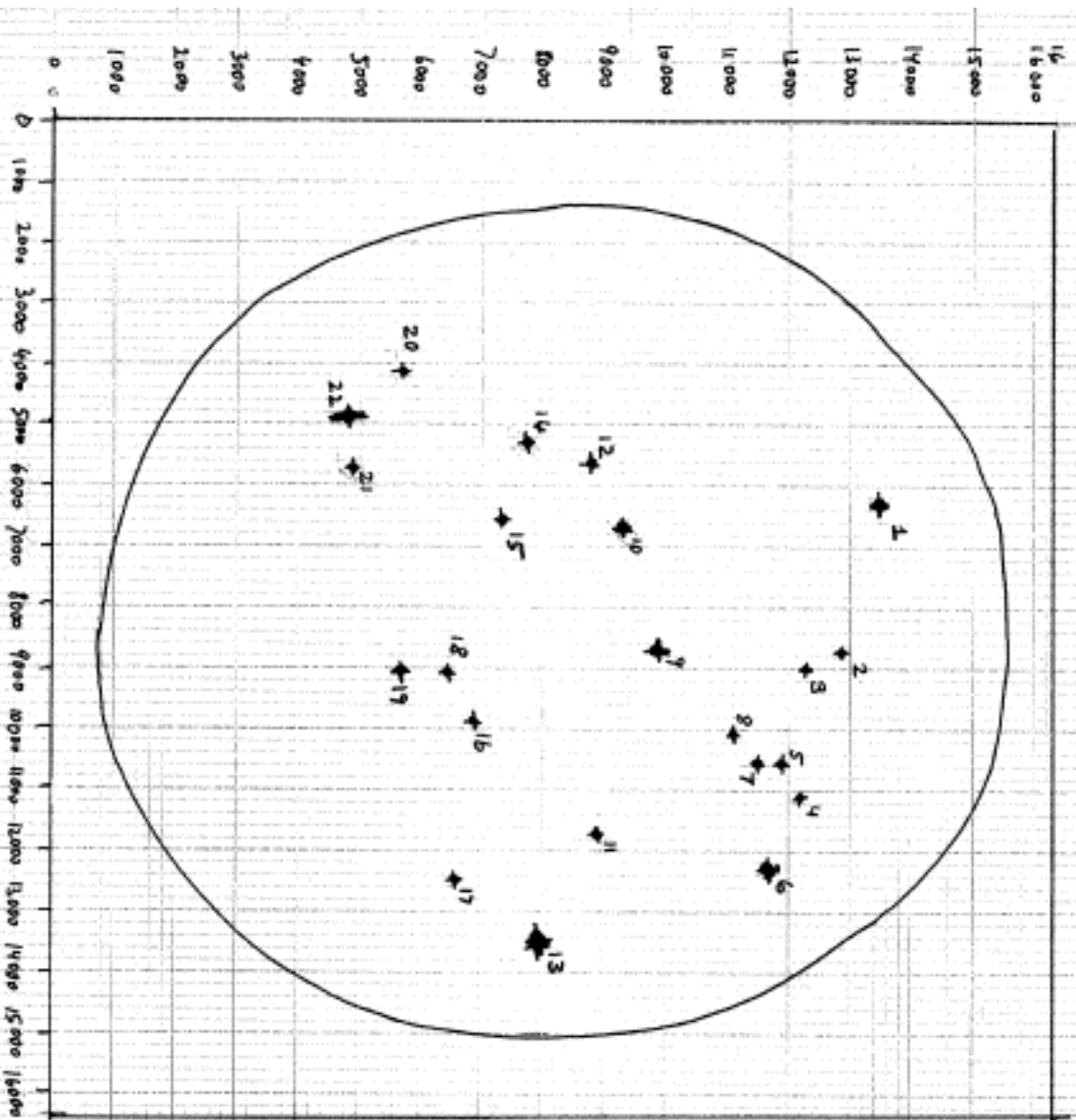

LIST OF BEELER'S CRATERS ON NEW VIDISSECTOR PHOTOCATHODE

	X	Y	Size (mm)	'Volume' (arbitrary scale)
1	6370	13420	.33	.16
2	8700	12830	.25	.09
3	9000	12280	.25	.10
4	11080	12200	.25 by .40	.08
5	10460	11900	.25 by .33	.10
6	12270	11700	.28	.13
7	10570	11520	.17	.09
8	10080	11110	.18	.10
9	8770	9850	.35	.14
10	6700	9280	.12 by .33	.11
11	11720	8940	.12	.09
12	5620	8800	.17	.10
13	13580	7980	.50	.70
14	5280	7730	.12 by .40	.10
15	6560	7350	.08 by .20	.07
16	9900	6870	.33	.08
17	12460	6570	.33	.09
18	9060	6460	.25	.08
19	9030	5760	.08 by .25	.10
20	4040	5680	.16 by .40	.08
21	5620	4920	.16 by .40	.08
22	4930	4820	.16 by .85	.16

### THE OLD VIDISSECTOR:

The old vidisector can be accessed through the video-processor much the same way as the new one. Major differences exist in noise levels:

CPL	Noise (variance)/signal(average)	
	NEW	OLD
0	.11	.25
1	.054	.13
2	.028	.068
3	.016	.036

There also exist a number of interactions in the wiring causing both measured intensity and noise to vary with the state of other electrical equipment near by.

The lens is a Canon F1.3 Zoom lens ( 15 mm - 140 mm) (which seems to have too small a field of view for the photocathode). The zoom and focus servo data can be found in the following table:

Function	Input	Output	Limits
Zoom	25	63	2013. - 4000.
Focus	26	64	850. - 4000.

Because of the noisyness of the Monitor-display it was not possible to set up experiments to measure the parameters found for the new vidisector.

The lens is connected to a 1.6 times expander which changes its field of view to the required 26 mm, its f-number to 2.08 (nominally) and its focal length to 24 mm - 492 mm.

# Canon MANUAL ZOOM LENS V8 X 15

15mm—120mm F1.3

• BRIGHTEST 1:1.3 - 8 TIMES MANUAL ZOOM LENS

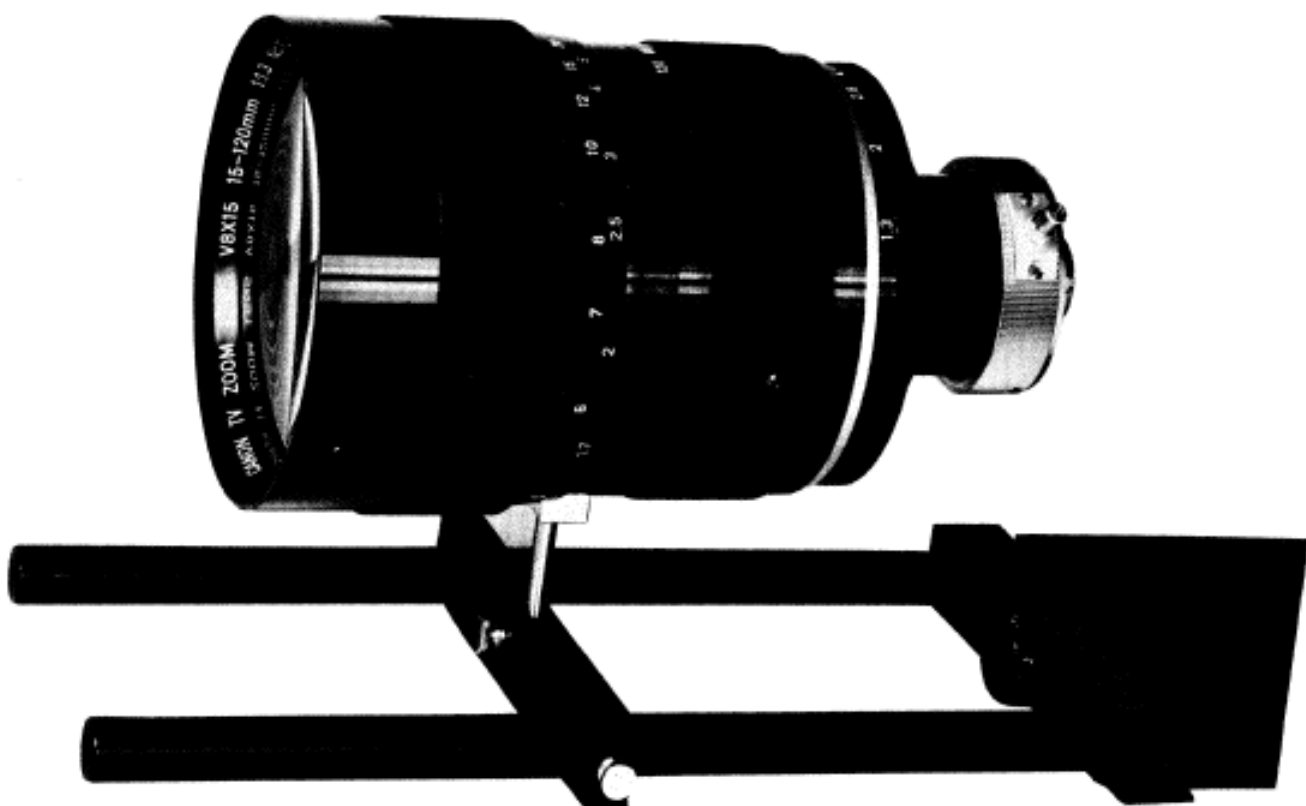

FIG. 17

- The image is superbly sharp even at maximum aperture opening and especially so when the aperture is closed down. Because aberration correction has been made for vidicon and 16 mm film camera use.
- Brightest 16 mm zoom lens with f 1.3 speed for entire 15-120 mm zoom range.
- Constant focus through entire zoom range.
- Finest color correction by patented "spectra" coating with amber and magenta colors.
- Anti-reflection multicoating: Prevent loss of lightflares and ghosts to the lens surfaces.
- Most satisfactory performance assured by 30 years of proven lens research and manufacture.

**Canon** USA, INC.  
550 FIFTH AVENUE  
NEW YORK, N.Y. 10036  
212/581-2970

AUTHORIZED SALES

SENSITIVITY OF THE  
PHOTOCATHODE OF THE  
OLY VISA SECTOR:

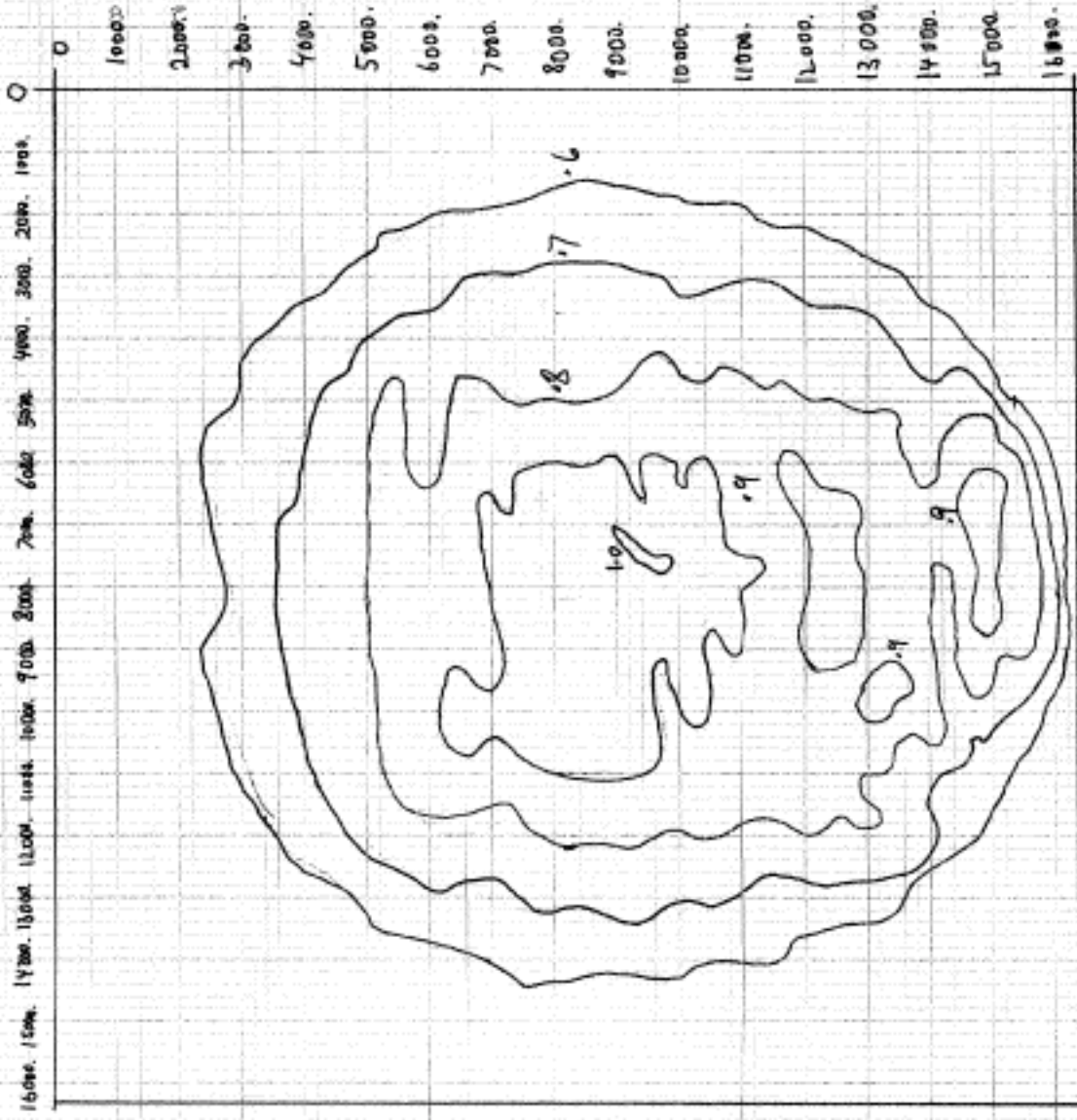
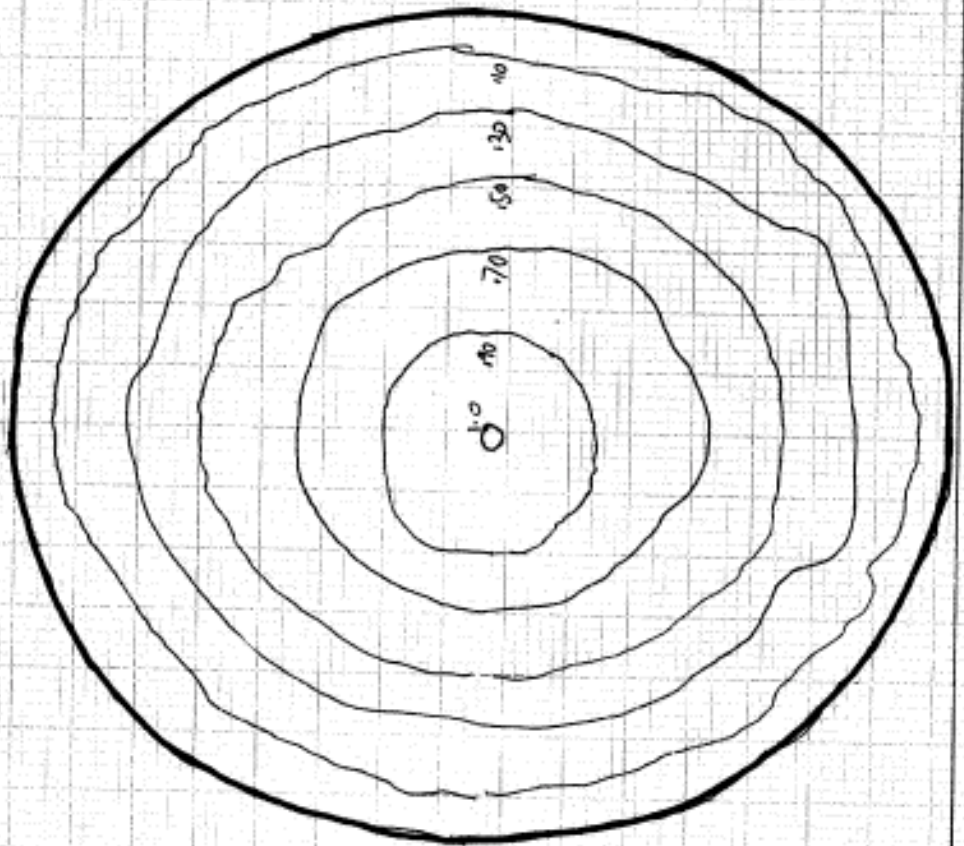

Fig 18

16000. 15000. 14000. 13000. 12000. 11000. 10000. 9000. 8000. 7000. 6000. 5000. 4000. 3000. 2000. 1000. 0



SENSITIVITY OF OLD VIDUVECTOR  
WITH IRLE FULL OPEN:  
CANON ZOOM LENS  
(THE OUTLINE OF THE FIELD  
OF VIEW IS FAIRLY ACCURATE)

Fig 19

art 2