



CD-ROM Drive
Operation Manual

PX-43CH Internal CD-ROM Drive
PX-45CH External CD-ROM Drive

FCC NOTICE

This equipment has been tested and found to comply with the limits for a Class B digital device, pursuant to Part 15 of the FCC Rules. These limits are designed to provide reasonable protection against harmful interference in a residential installation. This equipment generates, uses, and can radiate radio frequency energy, and, if not installed and used in accordance with the instructions, may cause harmful interference to radio communications. However, there is no guarantee interference will not occur in a particular installation. If this equipment causes harmful interference to radio or television reception, which can be determined by turning the equipment off and on, the user is encouraged to try to correct the interference by one or more of the following measures:

- Reorient or relocate the receiving antenna.
- Increase the separation between the equipment and receiver.
- Connect the equipment into an outlet on a circuit different from that to which the receiver is connected.
- Consult the dealer or an experienced radio/TV technician for help.

Any changes or modifications should be approved by the party responsible for compliance of FCC Rules; otherwise, the user loses authority to operate the equipment.

CAUTION

Use of controls or adjustments or performance of procedures other than those specified herein may result in hazardous radiation exposure.

The laser beam emitted from the optical pickup is invisible. Accordingly:

- **Do not open the optical pickup housing.**
- **Obtain service only from Plextor-authorized personnel.**

CAUTION

To disconnect the CD-ROM drive from an electrical current, pull out the power plug.

VORSICHT

DIE TRENNUNG VOM NETZ ERFOLGT DURCH ZIEHEN DES NETZSECKES.

Zur Einhaltung der Funk-Entstörung von nicht selbständig betreibbaren Hochfrequenzgeräten (periphere Anlagenkomponenten).

Dieses Gerät entspricht als Einzelgerät den Funk-Entstöranforderungen der Postverfügung Nr. 243/1991. Wird das Gerät innerhalb einer Anlage zusammen mit anderen Geräten betrieben. So muß bei Inanspruchnahme der "Allgemeinen (Betriebs-) genehmigung" nach der BMPT-AmtsblVfg Nr. 243/1991 die gesamte Anlage folgenden Richtlinien entsprechen:



ÜG-Vfg.243

- Grenzwertklases B der EN55022
- Auflagen nach § 2 der BMPT-AmtsblVfg 243/1991

Dies ist bei der Zusammensetzung einer Anlage (z.B. Computersystem) aus nur einzeln geprüften Geräten nicht immer erfüllt.

CD-ROM DRIVE

PX-43CH Internal
PX-45CH External



Plextor reserves the right to make improvements in the products described in this manual at any time without prior notice.

Plextor makes no representation or warranties with respect to the contents hereof and specifically disclaims any implied warranties of merchantability or fitness for any particular purpose. Further, Plextor Corp. reserves the right to revise this manual and to make changes in its content without obligation to notify any person or organization of such revision or change.

This manual is copyrighted, all rights reserved. It may not be copied, photocopied, translated, or reduced to any electronic medium or machine-readable form without Plextor's prior permission.

Manual copyright © 1994 Plextor Corp. First edition June, 1994.

Licenses and Trademarks

All licenses and trademarks are property of their respective owners.

Table of Contents

1. Introduction	1
2. Box Contents	2
Internal Drives	3
External Drives	4
A Gentle Reminder...	5
3. What Else Do I Need?	6
4. Precautions	8
5. Drive Features	9
Internal Drive	
Front Panel	9
Rear Panel	10
External Drive	
Front Panel	11
Rear Panel	12
6. Drive Switch/Jumper/Dial Settings	13
Internal Drive	14
SCSI ID Number	15
External Drive	16
SCSI ID Number	15
Other Switch/Jumper/Settings	16
7. Termination	18
Internal Drive	19
External Drive	19

8. Hardware Installation	20
Board Installation	21
Drive Positioning	24
Mounting an Internal Drive	25
External Drive Installation	29
Soundboard Installation	32
Audio Cables	33
9. Software Device Driver Installation	34
example: Future Domain TMC-1610M for PCs	35
example: FWB Toolkit for MACs	37
10. Special Operating System Notes	38
OS/2	38
Windows NT	40
11. Using CD-ROM Discs and Caddies	42
Inserting the Disc into a Caddy	42
Loading the Caddy into the Drive	43
Removing the Caddy from the Drive	44
Cleaning the Disc	44
12. How To Play Music CDs on your Drive	45
13. Troubleshooting	48
14. Contacting Plextor's Technical Support Department	63
How to Contact.	64
Before You Call	64
Returns (RMA)	65
Helpful Phone/FAX/BBS Numbers	65
15. Specifications	66
About Plextor	68
Warranty Information	Inside Back Cover

Introduction

Thank you for purchasing a Plextor 4PleX CD-ROM drive. We appreciate the confidence you have shown in our ability to put you — and keep you — on the leading edge of CD-ROM drive performance.

To get you there, we first have to help you install your 4PleX drive properly, and operate it correctly. After that, the responsibility is yours; to seek the applications that make a CD-ROM drive such a powerful and exciting addition to your system.

For those of you with PCs, the installation process may seem a bit complicated (Mac people have it easy). Fear not. We have successfully walked through the installation process with many customers who previously had lived in mortal terror of the innards of their computer.

In this manual you should find all the information you need to successfully install and operate your drive. However, if you run into a problem CALL US (see Chapter 14 for the different ways you can contact us). The call is toll-free. You will be connected to our friendly, helpful band of tech support reps who know their stuff about CD-ROM drives. What might seem like a lost cause to you could very well be a 30 second fix to them. But we will never know unless you CALL US. If you are having trouble, please don't give up and don't take your drive back to where you bought it until you have spoken with one of our tech support reps.

This manual is designed to be followed in sequence. It is aimed primarily at those who will connect their 4PleX drive to a PC. Mac users should look for this symbol:



Users of UNIX based systems should look for this symbol:



as an indicator of sections of the manual that pertain to them.

Many of you reading this manual are experienced computer users who have successfully installed peripherals in the past. There probably are a number of sections in this manual that you can skip over. However, we ask everyone — from novice computer users to experienced computer professionals — to read the sections marked with this symbol:





Box Contents

YOUR TASK: Check the contents of the box.

YOUR OBJECTIVE: Make sure you got everything you paid for.

YOUR METHOD: Compare what you find in the box with the tables on the following pages.

What you should find in your Plextor box depends on two factors: 1) what configuration you purchased; and, 2) what the company that sold you the box put in — or took out — while it was in their possession.

Plextor currently sells its 4PleX drives in four configurations:

- 1) Drive Only
- 2) Drive with 16-bit SCSI Interface Board Kit
- 3) Drive with 16-bit Soundboard Kit
- 4) Drive with Mac Kit

The configuration you received is indicated by stickers applied to your box.





PLEASE NOTE: A security sticker was applied to the top of your box. The contents of your box were carefully checked before this sticker was applied. If it was cut before you purchased the box, you should carefully check the contents to ensure nothing has been removed. If something is missing, you should contact the party from whom you purchased the box for an explanation.



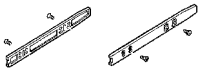

There may be a perfectly good reason why the security sticker on the box was cut before you received it. For example, a dealer may have purchased a “Drive Only” configuration from Plextor, then added a SCSI interface board and/or software he had purchased separately before selling the box to you.

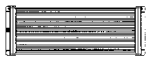
Use the following tables to check the contents of your box:

PX-43CH Internal Drives

	DRIVE ONLY	DRIVE w/ 16-bit SCSI Interface	DRIVE w/ Soundboard
CD-ROM drive 	X	X	X
Side rails with 4 chrome and 4 black screws 	X	X	X
Caddy 	X	X	X
16-bit SCSI interface board with device drivers on floppy disk & board manual		X	
Audio cable			X
SCSI cable 		X	X
Soundboard with device drivers on floppy disk & soundboard manual			X
Plextor operation manual	X	X	X
Warranty registration card	X	X	X
Extra jumpers for setting drive switches 	X	X	X

PX-45CH External Drives

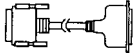
	DRIVE ONLY	DRIVE w/ 16-bit SCSI Interface	DRIVE w/ Sound-board	DRIVE w/ Mac Kit
CD-ROM drive 	X	X	X	X
Caddy 	X	X	X	X
Terminator 	X	X	X	X
Bracket Connector			X	
16-bit SCSI interface board with device drivers on floppy disk & board manual		X		
Audio Cable			X	
SCSI cable 		X	X (2)	X
Sound board with device drivers on floppy disk & soundboard manual			X	
Plextor operation manual	X	X	X	X
Warranty registration card	X	X	X	X
Mac device drivers manual & disk				X



A Gentle Reminder. . .

- YOUR TASK:** Save your box (if you received one).
- YOUR OBJECTIVE:** Have a secure container in which to ship your drive back to Plextor, if necessary.
- YOUR METHOD:** Find an empty space in your home/office, fill it with the Plextor box.
-

If you received your 4PleX CD-ROM drive in a Plextor box, you should save the box after you have installed your drive. There are many sets of hands — some of them potentially unfriendly — that a 4PleX drive might go through on its way from us to you. Our box and its packaging material were designed and drop tested to ensure that your 4PleX drive can endure rough treatment and still arrive in working order.



We advise you to hold onto your box in case you should ever need to return your drive to Plextor for any reason. Unfortunately, some of our customers have not held onto their boxes, and have had to resort to some less-than-secure methods to get drives back to us. We have received drives in a shoebox, in an unpadded express mail envelope, and in a box filled with buttered popcorn.

We cannot assume liability for any damage your drive sustains during shipment. Therefore, please ship your drive in the safest manner possible. We believe your drive will be most secure if it is shipped in a Plextor box. We hope you will never have to ship your drive back to us. If you do, however, we hope you will send it packaged in a Plextor box.

If you did not receive a Plextor box (if, for example, your drive came pre-installed in a computer), we recommend that you pay a packaging store (e.g., Mailboxes, etc.) in your area to ship your drive. The drives that we have received from most packaging stores have arrived in good shape. If you don't have a packaging store in your area, call our tech support department for packaging pointers before you ship your drive. In fact, you should call our Technical Support Department to get an RMA number before returning any drive (see Chapter 14, p. 65).



What Else Do I Need?

YOUR TASK: Review the software and hardware installed in your current computer system.

YOUR OBJECTIVE: Determine what else you may need to operate your CD-ROM drive.

YOUR METHOD: Inventory your current computer system; check list below.



If you are a PC owner and you purchased a Plextor box labeled “Drive with 16-bit SCSI Interface Kit” or “Drive with 16-bit Soundboard Kit” your needs are simple: none. The same holds true if you are a Mac owner and purchased a Plextor box labeled “Drive with Mac Kit.” Everything you need to successfully install and operate your 4PleX CD-ROM drive is included in the box you purchased. The only thing you need to add is a CD-ROM disc to play in your new drive.

If you are a PC owner who has purchased a 4PleX “Drive Only” box, life gets a bit more complicated. You fall into one of three groups:

1) You do not own a SCSI interface board.

In which case, you have to get one. Your local computer store and numerous mail-order vendors carry them. Call us if you need suggestions on which model to buy. You also will need to buy a SCSI ribbon cable to connect the board to an internal drive, or an external SCSI cable to connect the board to an external drive.

2) You own a SCSI interface board.

If you already have other SCSI peripherals (e.g., hard disk, scanner, tape drive) connected to the board, you will need a daisy chain cable that can connect one board to multiple SCSI peripherals. If you have a SCSI interface board, but the CD-ROM drive is the only SCSI peripheral you will connect to it, you can use cables such as those mentioned in #1 above.

If you purchased your SCSI interface board several months or years before you purchased your 4PleX drive, you may need to update your device drivers. See the discussion about device drivers in Chapter 9 of this manual.

3) You own a soundboard that has a SCSI interface built into it (e.g., Sound Blaster SCSI II).

You may need to add a SCSI cable and, most important, an audio cable (see page 33 for a discussion on audio cables). If you have an external drive you

will need two SCSI cables (internal and external), an audio cable, and a special bracket that plugs into the back of your computer. The bracket acts as the point where cables inside your computer connect to cables outside your computer (and onto your CD-ROM drive).

You also may need to update your device drivers. See the discussion about device drivers in Chapter 9 of this manual.

Once you have assembled everything you need, you're ready to install your drive. But first, a few words of caution are in order.



Precautions

YOUR TASK: Read the list of precautions below.



YOUR OBJECTIVE: Avoid any undo harm coming to you or your drive.

YOUR METHOD: Review the list and use common sense.

Your new CD-ROM drive is a precision electromechanical device. Like the rest of your computer system, it requires reasonable care in its installation and use.

Please read this manual carefully and keep it handy for easy reference. Use this manual for installation, operation, and troubleshooting. See your dealer or call Plextor's Technical Support Department should your drive require repair or service.

- X Do not put your computer monitor (or any other device weighing more than 30 lbs.) on top of the PX-45CH external drive.
- X Do not place either the PX-43CH or PX-45CH drive in direct sunlight, on heating units, or near electrical appliances which draw large amounts of current, such as a high-powered audio amplifier, microwave oven, toaster, hair dryer, etc.
- ✓ Keep the area around your drive clean from dust, smoke, and other contaminants.
- ✓ Use a soft, dust-free cloth for cleaning your drive. Do not allow moisture or liquids including water, cleaning fluids, or solvents to touch the drive. Thinner, benzene, or alcohol-based solvents can mar your drive's surface.
- ✓ To help ensure that your CD-ROM discs remain free of dirt or other contaminants, your drive requires a disc caddy. Use only an industry standard disc caddy. Do not insert a warped or cracked disc caddy into the drive.
- ✓ Keep your CD-ROM disc clean. See Chapter 11 for tips on handling and cleaning CD-ROM discs.
- X Do not drop or jolt the drive.
- X Do not attempt to open the drive and service it yourself. Removing the cover may expose you to harmful electrical voltages or the laser beam. For your safety, entrust service to Plextor-authorized service personnel only.

Only CD-ROM discs carrying this label may be used with this drive:





Drive Features

YOUR TASK: Get to know your drive.

YOUR OBJECTIVE: Learn how to operate different features of the drive. Learn what goes where. Learn some terms that will be used elsewhere in the manual.

YOUR METHOD: Match the different parts of your drive to the diagrams below.

PX-43CH Internal Drive Front Panel

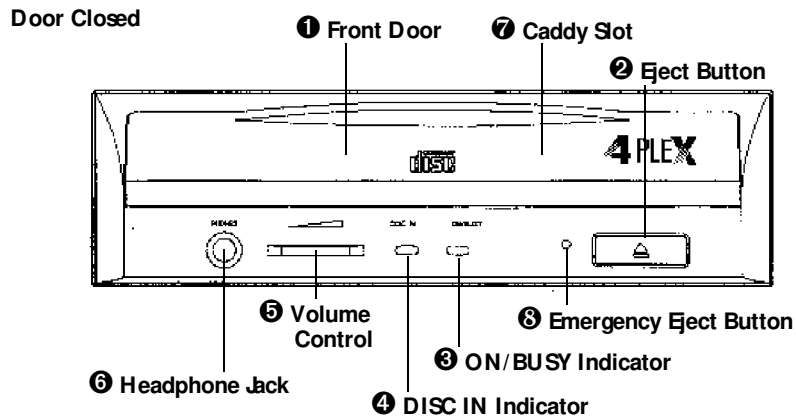

1 Front Door: Open to insert caddy.

2 Eject Button: Push to eject caddy.

3 ON/BUSY Indicator: Yellow when power is on. Flashing when disc is inserted and being accessed. Off when disc is inserted and not being accessed.

4 DISC IN Indicator: Green when power is on and disc is inserted. Off if no disc is inserted.

- ⑤ **Volume Control:** Controls volume of headphone jack. This control has no effect on the rear panel audio outputs.
- ⑥ **Headphone Jack:** Stereo mini-jack for headphones and powered speakers.
- ⑦ **Caddy Slot:** Insert caddy after opening door.
- ⑧ **Emergency Eject Hole:** Insert paper clip or other thin, rigid object to eject caddy if automatic eject button ② does not work. Turn off power before using this feature.

PX-43CH Internal Drive Rear Panel

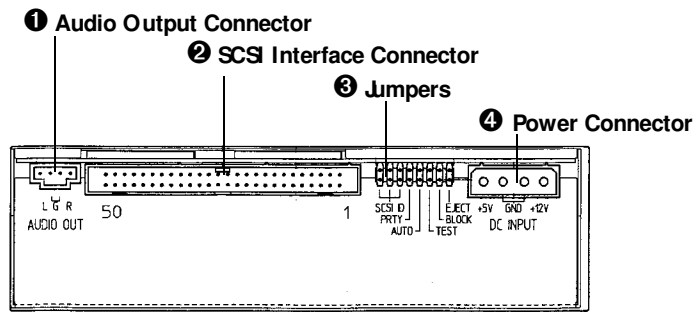

① **Audio Output Connector:** Outputs stereo analog signal. Use to connect to sound board or audio amplifier.

② **SCSI Interface Connector:** Connects to SCSI interface board using 50-pin to 50-pin flat ribbon SCSI cable.

③ **Jumpers:** Use to select SCSI ID number, parity, auto, test, block size and eject lock options. Leave these jumpers at their factory settings unless one or more of the following situations pertain to you:

SCSI ID number: If you are using more than one SCSI peripheral, you may have to change your SCSI ID number. See page 15.



Block size: If you are working in a UNIX environment and want to boot from your CD-ROM drive, see page 17.

Eject lock: If you work in an environment where you need to prevent others from easily removing a CD-ROM disc from your drive, see page 17.

④ **Power Connector:** Connects to your computer's power supply (DC +5V and +12V).

PX-45CH External Drive Front Panel

Door Closed

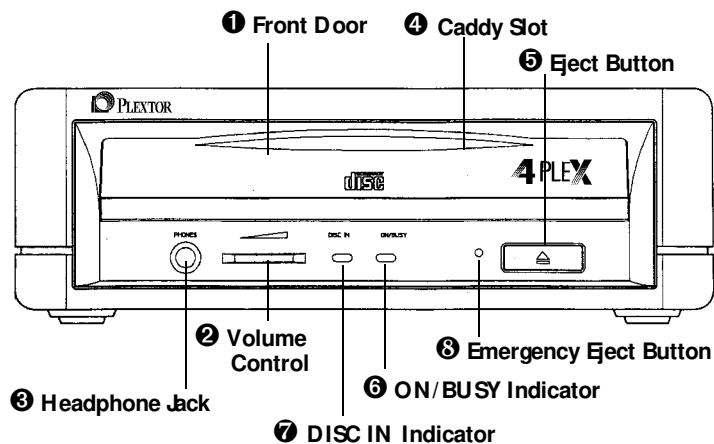

- ❶ **Front Door:** Open to insert caddy.
- ❷ **Volume Control:** Controls volume of headphone jack. This control has no effect on the rear-panel audio outputs.
- ❸ **Headphone Jack:** Stereo mini-jack for headphones and powered speakers.
- ❹ **Caddy Slot:** Insert caddy after opening door.
- ❺ **Eject Button:** Push to eject caddy.
- ❻ **ON/BUSY Indicator:** Yellow when power is turned on. Flashing when disc is inserted and being accessed. Off when disc is inserted and not being accessed.
- ❼ **DISC IN Indicator:** Green when power is on and disc is inserted. Off if no disc is inserted.
- ❽ **Emergency Eject Hole:** Insert paper clip or other thin, rigid object to eject caddy if automatic eject button ❺ does not work. Turn off power before using this feature.

PX-45CH External Drive Rear Panel

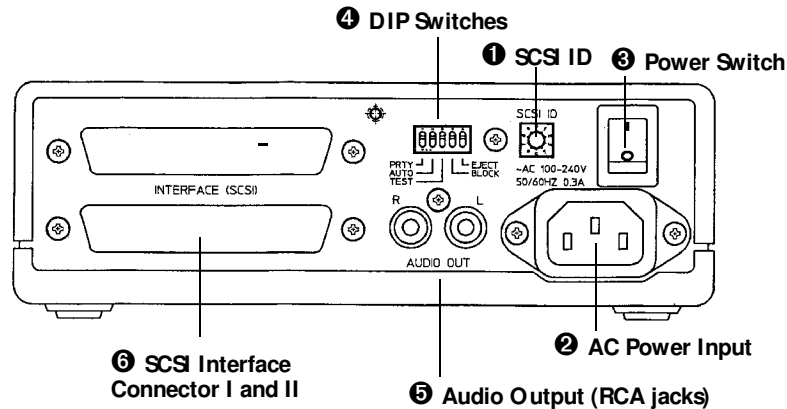

1 SCSI ID: Use this dial to designate SCSI ID number. Rotate the dial to change the number.

2 AC Power Input: Use the power cord supplied with your drive.

3 Power Switch: To turn power ON/OFF.

4 DIP Switches: Use to set parity, auto, test, block size and eject lock options. Leave these switches at their factory settings unless either or both of the following situations pertains to you:



Block size: If you are working in a UNIX environment and want to boot from your CD-ROM drive, see page 17.

Eject Lock: If you work in an environment where you need to prevent others from removing a CD-ROM disc from your drive, see page 17.

5 Audio Output: Outputs stereo analog signal via RCA jacks. Use to connect to audio amplifier or other audio equipment.

6 SCSI Interface Connector I and II: One connector should be used to link your CD-ROM drive to your SCSI host adapter; the other to link your CD-ROM drive to another SCSI peripheral with a daisy chain cable (see page 31). You may use either connector for either purpose.

Drive Switch/ Jumper/Dial Settings



YOUR TASK: Find the location of jumpers (internal drive) or switches and rotary dial (external drive). Check their settings. Change them, if necessary.

YOUR OBJECTIVE: To ensure that your new CD-ROM drive can coexist peacefully with other equipment you might have installed in your computer. To ensure that your drive will work properly after it is installed.

YOUR METHOD: Find locations of jumpers/switches/rotary dial on diagram in Chapter 5. Read below to determine if your drive's settings need to be changed. If so, follow the directions on making the necessary changes.

Your 4PiX CD-ROM drive needs to be flexible enough to work with the variety of computer systems (PC, Mac, Sun, Silicon Graphics, DEC, etc.) that can use SCSI peripherals. To provide this flexibility, Plextor gives its customers options on how a drive can be set before it is installed. On an internal drive, settings are determined by the position of jumpers on the jumper block at the rear of the drive. On an external drive, settings are determined by the position of dip switches and the rotary dial on the rear panel of the drive.

Fortunately, we have a pretty good idea of the environment in which most of our drives will be used (a single SCSI device connected to a PC or Mac). Your drive ships from our factory with its jumpers/switches/dial set to work in this environment.

You should leave the jumpers found on the rear panel of the PX-43CH and the switches and rotary dial found on the rear panel of the PX-45CH at their factory settings unless: 1) you plan to use another SCSI peripheral (e.g., hard disk, scanner) with your computer system in addition to your CD-ROM drive; 2) you work in a UNIX environment and want to boot from your CD-ROM drive; 3) you want to utilize the Eject Lock feature. If you plan to use additional SCSI peripherals, you may need to change the jumper/switch/dial settings of the PX-43CH / 45CH. This section will describe how to make these changes. For information on #2 and #3, see page 17.



If the CD-ROM drive is the only SCSI peripheral you will use with your computer, you do not need to boot from the CD-ROM drive in a UNIX environment. If you do not plan to use the Eject Lock feature, skip now to Chapter 8, Hardware Installation. (Take our word for it, most of you can now skip to Chapter 8.)

PX-43CH Internal Drive

Factory Setting of Jumper Block

The functions shown are ON if the jumpers are installed and OFF if jumpers are removed. The jumpers are set by the factory as follows:

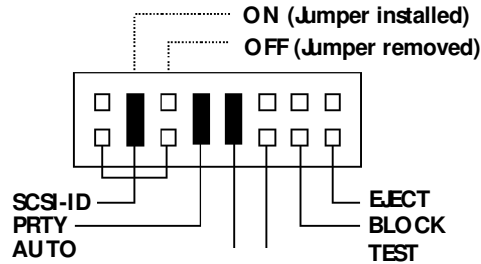

Installing and Removing Jumpers

Ensure power to the drive is OFF before installing or removing jumpers.

Identify the appropriate pin number by looking for the pin labeled 1 on the green circuit board. The pins to the right of it are 2, 3, 4, 5, 6, 7 and 8 respectively.

To remove a jumper, pull it off with your fingers or a pair of needle-nose pliers.

To add a jumper, push it onto the jumper pins. Three extra jumpers are supplied with the PX-43CH in addition to the three jumpers already installed at the factory.

Caution: Install jumpers **across** each pin as shown. Do **not** connect one pin switch to another by installing the jumpers lengthwise. Doing so could result in damage to the drive.

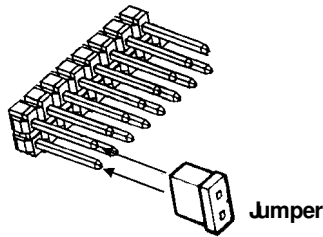

Install Jumpers This Way



Do **NOT** Install Jumpers This Way

SCSI ID Number

It is possible to chain (using a daisy chain cable) up to seven SCSI peripherals to a single SCSI interface board, or to the SCSI port of an Apple computer. However, when using multiple SCSI peripherals, it is necessary to set each peripheral to a unique SCSI ID number.

Your Plextor CD-ROM drive can be set to use one of eight SCSI ID numbers. The drive should arrive with its SCSI ID set to 2. Accordingly, if you already use another SCSI peripheral and its SCSI ID also is set to 2, you must change the SCSI ID number of either this peripheral or the CD-ROM drive.

Changing the SCSI ID : PX-43CH

The SCSI ID number of the PX-43CH is determined by the placement of jumpers on pins 1, 2 and 3. To change the SCSI ID number, follow the chart below.

SCSI ID Number	Jumper Installed Across		
	Pin 1	Pin 2	Pin 3
0	No	No	No
1	YES	No	No
Factory Settings 2	No	YES	No
3	YES	YES	No
4	No	No	YES
5	YES	No	YES
6	No	YES	YES
7	YES	YES	YES

For example, the factory setting of the SCSI ID at 2 is made by installing a jumper across pin 2 of the jumper block, leaving pins 1 and 3 uncovered. To set the SCSI ID at 7 you would install a jumper across pin 1, another jumper across pin 2, and a third jumper across pin 3. To set the SCSI ID at 5, you would install a jumper across pin 1 and a jumper across pin 3, leaving pin 2 uncovered.

PX-45CH External Drive

SCSI ID Number

Please see description on page 15. It is also applicable to the external drive.

Factory Setting of Dial and DIP Switches

Caution: Turn the drive's power OFF before changing the setting of the dial or DIP switches.

The SCSI ID number of the PX-45CH is determined by the position of the pointer on the SCSI ID rotary dial. The drive should arrive with its SCSI ID set to 2. The rotary dial and DIP switches are set by the factory as shown below:

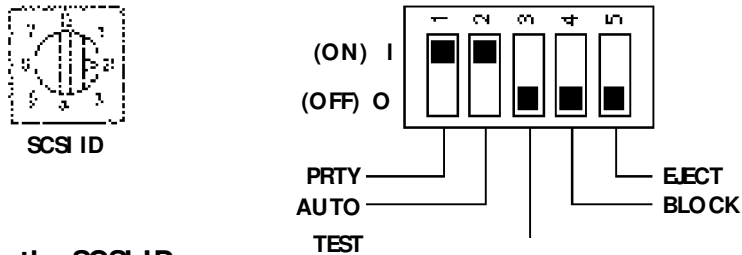

Changing the SCSI ID

Using the blade of a screwdriver, rotate the dial's arrow to a different SCSI ID number.

Changing DIP Switch Settings

Use a screwdriver, pen or paper clip to push the DIP switches to an OFF or ON setting.

Other Switch Settings—PX-43CH/ PX-45CH

The remaining switches are:

Parity Leave this ON. The parity check provided by the ON setting enhances the reliability of the SCSI bus with little or no noticeable affect on performance.

Auto Leave this ON unless you are having trouble reading a defective or damaged CD-ROM disc.

Normally, the data transfer rate for the drive is 600KB/sec from the data section of the disc and 150KB/sec from the audio section. However, your drive is designed to sense if it is reading a defective, damaged or poorly manufactured disc and adjust the data transfer rate accordingly.

With the AUTO switch ON, the drive first will attempt to read a disc at quad speed (600KB/sec). If it is unsuccessful, the drive automatically will switch to double speed (300KB/sec) and once again attempt to read the disc. If successful, the drive will continue at double speed until it receives the next read command. At this point, it will attempt to resume quad speed operation.

If your drive is unsuccessful in reading a disc at quad or double speed, it will slow to single speed (150KB/sec) and try a final time to read the disc. If successful, the drive will continue at single speed until it receives the next read command. At this point, it will attempt to resume quad speed operation. If it is unsuccessful in its attempt to read a disc at single speed, you will receive an error message.

You may override this feature and set your drive to operate only at single speed (150KB/sec) by setting the AUTO switch/jumper OFF. At this setting, the drive will transfer both data and audio at 150KB/sec.

We recommend that you set this switch/jumper OFF only under extreme circumstances (e.g., you have a badly damaged disc that you MUST get data from).

Test Leave this OFF. It is for factory use only.

Block Leave this OFF unless you are working in an UNIX environment and want to boot from your CD-ROM drive. If so, set this switch/jumper ON.



Eject In most situations, you will want to leave this switch/jumper OFF.

However, if you are in an environment where you want to prevent others from borrowing or stealing the disc inserted in your drive (e.g., the drive is located in a public place where multiple people have unlimited access), you can activate the Eject Lock feature. To do so, set this switch/jumper ON.

When this switch/jumper is ON, it is impossible to eject a disc inserted in the drive by pressing the Eject button. A software eject command must be issued for the disc to eject from the drive. Check your device driver manual for instructions on how to issue a software eject command.



Termination

YOUR TASK: Find the location of the terminator(s) on your drive.

YOUR OBJECTIVE: Determine if your drive must use a terminator(s).

YOUR METHOD: Find location of terminator(s) by checking diagrams in Chapter 5. If necessary, remove them by following instructions given below.

You must use a terminator if the PX-43CH or PX-45CH is the only SCSI peripheral used with your computer. In addition you must use a terminator if you are using multiple SCSI peripherals with your computer, and the PX-43CH or PX-45CH is positioned as the last peripheral in a daisy chain.

Any SCSI peripherals which are positioned between your SCSI host adapter and the last peripheral in a daisy chain should have their terminators turned OFF. Consult the manuals of these peripherals for the proper method of turning their terminators OFF.

Remember: Only the last SCSI peripheral in a daisy chain should have its terminator turned ON. If you have any SCSI devices chained after your PX-43CH or PX-45CH, you must turn OFF the PX-43CH's or PX-45CH's termination.

PX-43CH Termination

The PX-43CH is shipped from the factory with its termination turned ON. To turn termination OFF remove the black resistor blocks from the locations shown below:

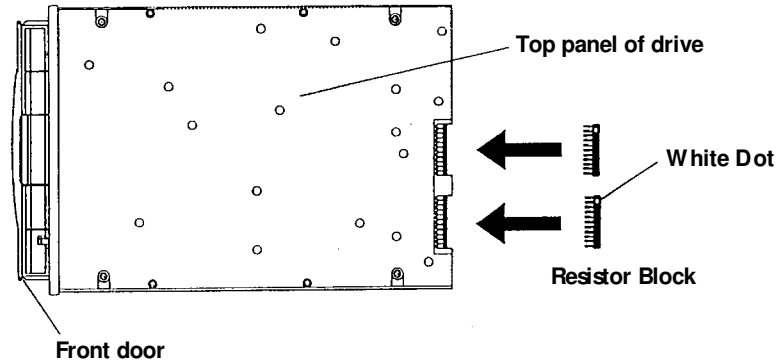

If your drive already is installed in your computer, be sure to turn off your computer power before removing (or reinstalling) the terminators. We recommend that you use needle nose pliers to remove the resistor blocks in order to avoid bending their legs. We also recommend that you retain the resistor blocks so you can reinsert them into the drive if you later need to turn the drive's termination ON. If you reinsert the resistor blocks, make sure that the side of the resistor block with a small white dot is facing UP.

PX-45CH Termination

The PX-45CH is shipped from the factory with a terminator installed on one of its SCSI connectors on the rear panel of the drive. When this terminator is installed, the drive's termination is turned ON.

To turn the termination OFF, first turn off the drive's power, then pull the terminator off the SCSI connector. We recommend that you retain the terminator so that it can be reinstalled if you later need to turn the drive's termination ON.

Hardware Installation

By itself, your CD-ROM drive is incapable of communicating with your computer. You must use a hardware link that enables your drive to “talk” with the rest of your computer.

Plexor’s 4PleX drives use a SCSI interface as their link. If you own a PC, there are four ways in which you can make the SCSI connection:

- 1) Use a separate 8-bit or 16-bit SCSI interface board. This is the most common method. We recommend using a 16-bit SCSI interface board to maximize the drives potential.
- 2) Use a soundboard that also has a SCSI interface built onto it. This helps save a slot in your computer by combining the functions of two boards (SCSI interface board and soundboard) into one. The downside of this is that most soundboards use only an 8-bit SCSI chip. If you need the performance a 16-bit SCSI interface board provides (see page 32), you’ll have to buy a separate board.
- 3) If you have an external drive, use a parallel-to-SCSI interface. This is a device that plugs into the parallel port (the one your printer normally is connected to) of your computer. It is convenient, but typically at a cost of reduced performance by your CD-ROM drive.
- 4) If you have an external drive and a portable computer with a PCMCIA slot, use a PCMCIA-to-SCSI card. This is a small, credit-card size device that plugs into the PCMCIA slot. It too is convenient, but again at a cost of reduced drive performance.

NOTE: The following section is only for PC users who need to install a SCSI interface board, or a soundboard with a built-in SCSI interface, in their computer. If you plan to use a parallel-to-SCSI, or PCMCIA-to-SCSI interface, you can skip to Chapter 9. If you are a MAC user, you can laugh at how easy life is and skip to page 29.



Board Installation

YOUR TASK: Install a SCSI interface board, or a soundboard with a built-in SCSI interface, in your computer.

YOUR OBJECTIVE: Provide the hardware link needed to enable your CD-ROM drive to communicate with your computer.

YOUR METHOD: Remove your computer's case. Install board and attach necessary cables.

Let us point out that this is a CD-ROM drive installation and operation manual — it is not a SCSI interface board or soundboard installation and operation manual. Unless you purchased a SCSI interface board or soundboard (and its accompanying manual) bundled in the same box with a 4PleX drive, we have no way of knowing which type of board you elect to use. There are dozens of SCSI interface boards and soundboards on the market. Each one is installed somewhat differently. Therefore, our instructions for this section should only be considered as guidelines. For more detailed instructions on how to properly install your SCSI interface board/soundboard, you should refer to the installation/operation manual that you received when you purchased the board.

Caution: If static electricity may be present in the room where you are working, discharge any you may have on your body by touching a grounded object before you remove the host adapter from its packaging.

Static electricity is a silent killer. Just a small jolt to one of the chips on your interface board may render it useless with no apparent damage visible. Positioning your computer in a location without a carpet underfoot is one method of guarding against static electricity damage. Using common sense, such as not walking on a carpeted floor in stocking feet just before you install your drive, is another.

Before proceeding, make sure the power to your computer and any external peripherals is OFF and your computer is UNPLUGGED from its power source.

To remove your computer's cover, follow the directions provided by your computer's manufacturer. Typically this involves loosening or removing several screws on the back panel of your computer and sliding off your computer's cover.

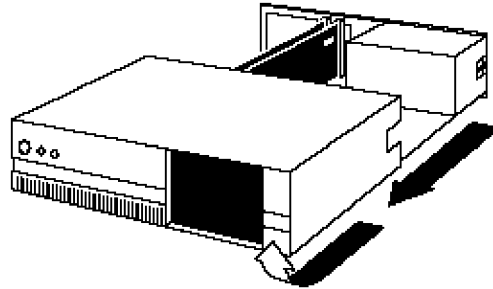

Carefully remove the SCSI interface board from its packaging. Select a vacant slot in your computer where you will install the board (refer to the manual packaged with your interface board for instructions as to which slot in your system to use). Plextor provides only 16-bit SCSI interface boards with its optional bundles, so you must use a vacant 16-bit slot (16-bit slots are longer than 8-bit slots). If you install an internal drive, try to pick a slot that is closest to where the drive will be installed.

Remove the cover plate for this slot from the back panel of your computer. Keep the screw from the cover plate nearby as you will need it in a moment. Save the cover plate in case you need it at a later date.

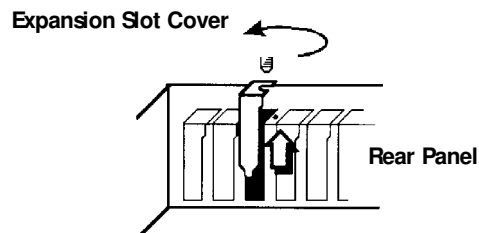

Plug the SCSI interface board into the slot you have selected. Rock the board from end-to-end to ensure that it seats firmly in the slot. Don't force it. If you cannot push the board down completely into the slot, remove the board and try again.

Once you have successfully inserted the board, fasten it in place using the cover plate screw that you removed earlier.

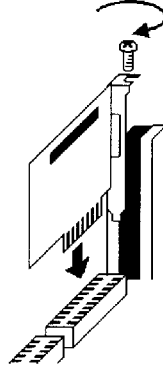



Drive Positioning

YOUR TASK: Determine where you want to install your drive.

YOUR OBJECTIVE: Position the drive in the proper manner so that it operates correctly.

YOUR METHOD: If you have an internal drive, find an open bay in your computer. If you have an external drive, find an open space on your desktop.

The PX-43CH and PX-45CH may be installed either horizontally or vertically. If installed vertically, make sure that the eject button is positioned near the top of the drive.

PX43-CH

Eject Button UP

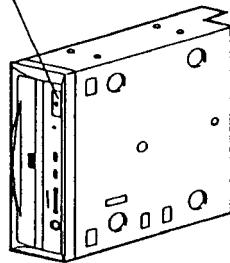

Vertical

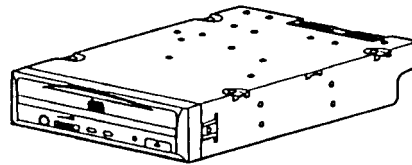

Horizontal

PX-45CH

Eject Button UP

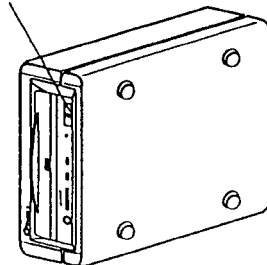

Vertical

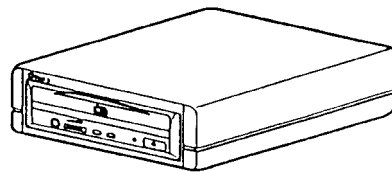

Horizontal

NOTE: The following section is only for those installing internal drives. If you have an external drive, skip to page 29.



Mounting an Internal Drive

YOUR TASK: Mount your internal drive inside your computer.

YOUR OBJECTIVE: A securely positioned drive whose connectors are within easy reach of the various cables that must attach to it.

YOUR METHOD: Identify the drive bay where you will mount your drive. Remove bay cover. If necessary, use mounting rails to install drive in bay.

Your PC probably looks something like this:

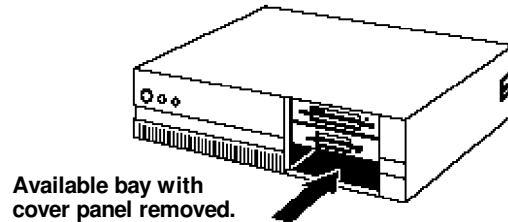

You can mount your drive in any available bay. You must remove the small panel that covers the bay that you want to use. This most typically is done after you have removed your computer's cover. The panel can then be popped out by pressing outward lightly (in some older cases you may have to remove screws that hold the panel in place).

You now need to determine if you must install mounting rails on the sides of your drive. To do so, insert the drive into the open bay. If the drive fits tightly with little (or no) clearance on either side of the drive, you will not have to use mounting rails. The drive can be mounted directly into your computer.

Caution: Do not mount your drive in your computer using screws other than those supplied by Plextor. You may damage the drive if you insert screws that are too long. If you find that you are having difficulty inserting or ejecting a caddy from your drive, the cause may be that you are using screws other than those supplied by Plextor. Another possibility is that you are using Plextor's screws, but you have tightened them too much. Try backing the screws out a few turns and see if this corrects the problem.



If you must use mounting rails, install them as shown below:

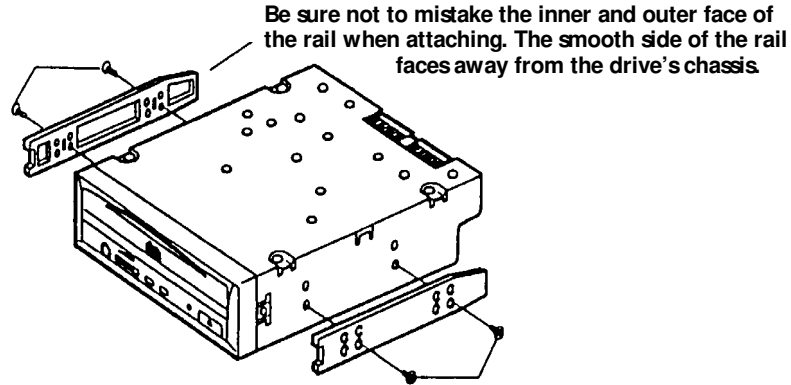

There are 4 holes provided on each side of the drive. To mount an internal drive in most computers, the rails should be fastened to the lower pair of holes. In some instances you may need to fasten the rails to the upper set of holes.

You will find that 8 screws were supplied with your drive: 4 chrome screws and 4 black screws. Select which screws to use based on which set of holes you use to attach the mounting rails.

- ✓ Use the *chrome* screws if you use the upper set of mounting holes.
- ✓ Use the *black* screws if you use the lower set of mounting holes.

Check the positioning of the rails by sliding the drive into the bay before you connect any cables.

Check Your Jumper Settings

Once you have determined a) the correct set of holes to use to attach mounting rails, or b) that you don't have to use mounting rails, you are almost ready to finish your drive's installation. However, before doing so, check your jumper settings one last time.

If you do not have any SCSI peripherals (e.g., hard disk, scanner, printer, etc.) in your system other than your CD-ROM drive, you should not change the jumpers from their factory setting.

If you do have other SCSI peripherals as part of your computer system, you may need to change the settings of the SCSI ID and Terminator. See Chapter 6 and 7 for information on how to change these settings.

Cable Connections

You must make a minimum of two cable connections to your CD-ROM drive. A third cable connection need be made only if you are using a soundboard in your computer.

The two cable connections which you must make are:

- 1) SCSI cable
- 2) power cable

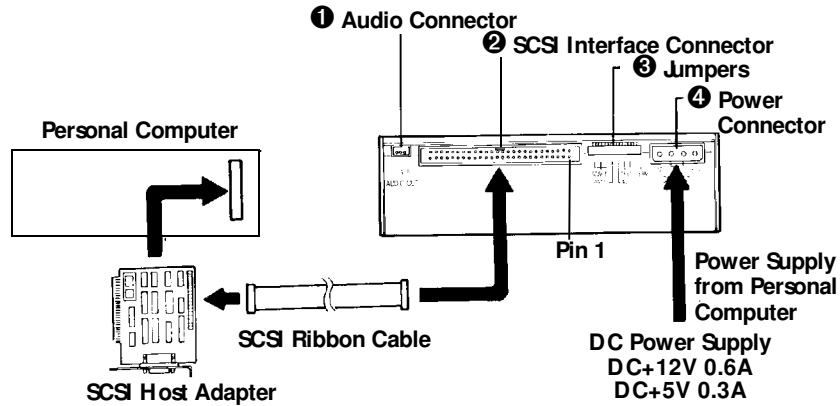

The SCSI cable should be a standard 50 pin flat SCSI ribbon cable. You should have received one at the time you purchased your SCSI interface board. If you did not, you can purchase one at most computer stores.



CAUTION: It is easy to accidentally plug your SCSI ribbon cable upside down into both your drive and SCSI interface board. Accordingly, be sure you match the red stripe along one side of the SCSI cable to pin 1 on the interface board and pin 1 on the drive (as shown on the next page).

Double-check your work; you must ensure the side of the SCSI cable with the red stripe is matched to pin 1 on the interface board and on the drive.

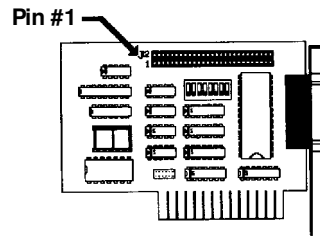
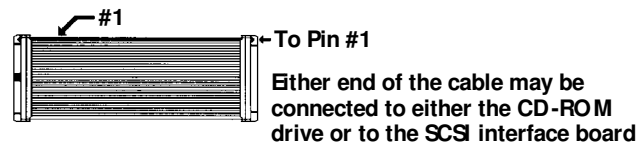

The easiest way to install your SCSI cable is to plug it into the SCSI connector on the rear panel of the drive before you insert the drive into your computer. Then you can thread the cable through the front of the open bay you plan to use and back toward the SCSI interface board. Connect the cable to your SCSI interface board and finish mounting your drive in the proper position. The drive should slide smoothly into the bay. If it does not, check for obstructions in the bay and ensure the side rails (if needed) are attached properly.

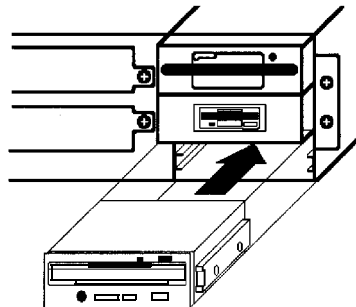

You now need to make the power connection. In most computers you will find additional power connectors that are ready for your use. Check the cable running from your power supply to your hard disk and see if it has extra connectors on it. If so, you can plug one of these into the power connector found on the rear panel of the CD-ROM drive.

If you do not find any additional connectors available (either because they were not supplied, or they are all in use), you will have to buy a "splitter" or a "Y-connector." These also can be found at most computer stores. If you are in a hurry to get started, you probably can unplug the power connector from your 5.25" floppy drive (if you

have one) and plug it into your CD-ROM drive. You will be able to use your CD-ROM drive until you have the opportunity to buy a “splitter” or “Y-connector.” (Of course, you will lose the use of your 5.25" drive until you buy a splitter/Y-connector.)

If your computer has only a 3.5" floppy disk drive, you may find that you do not have a power connector that is the correct size to plug into your CD-ROM drive. Once again, you can turn to your local computer store for a splitter to solve this problem, or you might find an adapter that converts the smaller sized power plug found on a 3.5" drive to the size required for your CD-ROM drive.

A third cable, an audio cable, must be used if there is a soundboard in your system. This cable runs from the four pin audio output connector on the rear panel of your drive to your soundboard. See page 33 for more information about audio cables.

Installation of your internal drive is now complete. Skip to page 32.



External Drive Installation



YOUR TASK: Connect cables from your external drive to your PC or Mac. Check to see if switch, dial and terminator settings need to be adjusted.

YOUR OBJECTIVE: A well functioning drive that does not conflict with any other peripherals in your computer system.

YOUR METHOD: Follow directions below for making cable connections. Review your current computer set-up to see if the potential for conflicts exist. If so, make necessary switch, dial and/or terminator changes.

If you are installing a single PX-45CH, and you have no other SCSI peripherals attached to your system, you should leave the switches, dial and terminator found on the rear panel of your drive at their factory settings. If you do have additional SCSI peripherals (e.g., scanner, printer) attached to your computer, you may need to change your switch, dial and terminator settings. See Chapter 6 and 7 for information on how to change these settings.

If you are installing a single PX-45CH external drive, connect it as shown on the next page:

PC connection

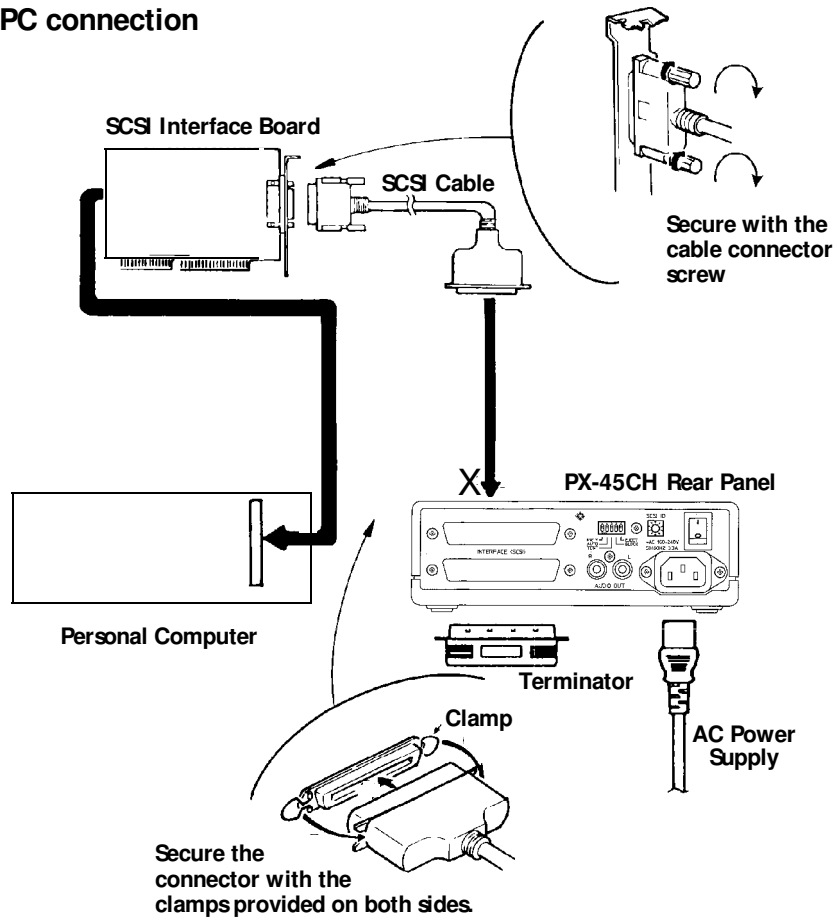

Mac connection (rear view of a Mac)

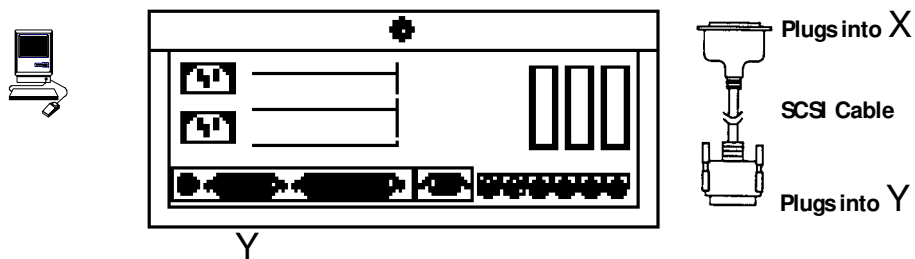

If you are installing more than one PX-45CH external drive (or one PX-45CH and other external SCSI peripherals), connect them as shown below:

PC connection

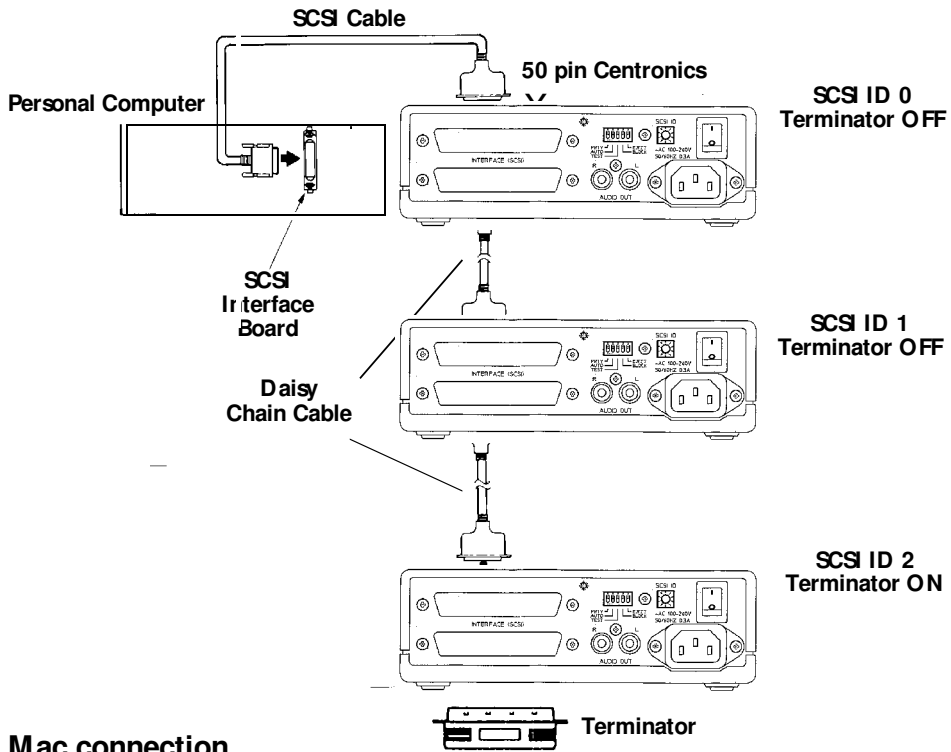

Mac connection
(rear view of a Mac)

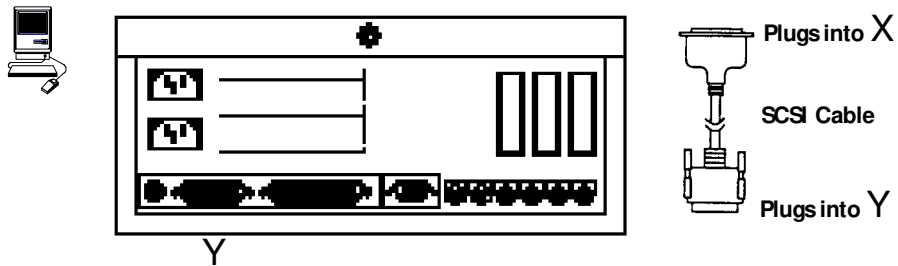

NOTE: The following section is only for those installing a soundboard in their PC. If you are not using a soundboard, skip to Chapter 9.



Soundboard Installation

- YOUR TASK:** Install a soundboard in your PC.
- YOUR OBJECTIVE:** Make sure that the soundboard works properly with your CD-ROM drive.
- YOUR METHOD:** Follow the instructions for installation that came with your soundboard. Follow the instructions given below to connect the soundboard to your CD-ROM drive.
-

From Plexor's perspective, soundboards fall into one of three major categories:

- 1) Soundboards that have no CD-ROM drive interface (e.g., ATI Stereo F/X, Logitech Sound Man 16, Turtle Beach Multi-Sound).
- 2) Soundboards that have a proprietary CD-ROM drive interface built onto the board (e.g., Creative Labs Sound Blaster, Orchid Sound Producer Pro, Wearnes Tech Beethoven ADSP-16). Typically, the only drives that can be attached are mediocre performers that sell for a low price.
- 3) Soundboards that have a SCSI CD-ROM drive interface built onto the board (e.g., Media Vision Spectrum 16, Diamond SonicSound, Prometheus Aria 16SE). Any SCSI CD-ROM drive can be attached to this type of soundboard and should work if the proper device drivers are used.

If you own a soundboard that falls into category #1 or #2 and want to use it with your 4PleX drive, you also must buy a separate SCSI interface board (e.g., Future Domain TMC-1610, Adaptec AHA-1515). You should follow the directions starting on page 21 regarding the installation of a SCSI interface board. Then, check the diagrams given on the following page to see how you should connect your audio cable.

If you own a soundboard from category #3, you probably do not have to buy a separate SCSI interface board. The only time when you might need a separate SCSI interface board — even though you have a category #3 soundboard — is if you have multiple SCSI peripherals (e.g., hard disk, scanner, printer) attached to your computer. In such a case you probably will want to buy a separate 16-bit SCSI interface board. This is because most soundboards with a built-in SCSI interface use only an 8-bit SCSI interface, which probably would not provide adequate performance if multiple SCSI peripherals were attached to it. (This is true even if you buy a “16-bit” soundboard.

The “16-bit” refers to the audio channel, not the SCSI data channel. The soundboard probably has only an 8-bit SCSI interface on it.)

No matter which category your soundboard falls into, you will find that the best source of information about installing the soundboard in your computer is your soundboard’s manual. Once you have successfully installed your soundboard in your computer, you can continue to the next section, which describes the different cable connections that need to be made.

Audio Cables

Yes, they drive us crazy, too. There is nothing more frustrating for our tech support staff than to encounter customers who have done a beautiful job installing their CD-ROM drive and soundboard, but can’t make the two “talk” to one another for want of a measly audio cable.

Why haven’t we included an audio cable with the 4PleX drive? BECAUSE WE DON’T KNOW WHAT KIND OF SOUNDBOARD YOU PLAN TO USE! (Unless, of course, you purchased a soundboard kit from Plextor. Then we know what kind of soundboard you will use and supply the appropriate cable.) There are dozens of soundboards on the market, and it seems that each of them uses a different audio connector. Although there has been some discussion of all the soundboard companies agreeing to use a common connector, thus far that happy day has not arrived.

Until it does, you will have to purchase an audio cable separately. We can help by recommending several vendors (see listing, p. 65) who offer audio cables, and can get them to you quickly at a reasonable price. Call our Technical Support Department directly at 800- 886-3935.

The following diagrams show where the SCSI cable and audio cable need to be connected to the 4PleX PX-43CH internal CD-ROM drive:

1 Audio Connector 2 Power Connector 3 SCSI Connector

Soundboard without SCSI Interface

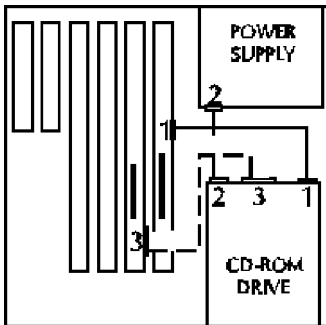

Soundboard with SCSI Interface

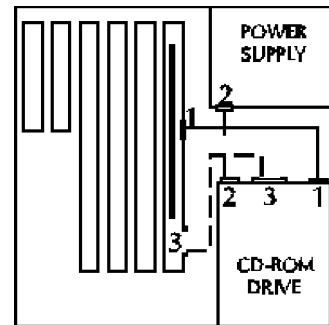



Software Installation

YOUR TASK: Install correct version of software device drivers into your computer system.

YOUR OBJECTIVE: Enable your CD-ROM drive to communicate with the rest of your computer system.

YOUR METHOD: Insert floppy disk containing device drivers into your floppy disk drive. Follow directions provided by supplier of device drivers so that you can copy the drivers to the proper location in your computer.

A device driver is a software program which allows your computer to interact with your CD-ROM drive. If you do not use a device driver, or you use an outdated version of the required device driver, you will not be able to operate your CD-ROM drive. The lack of a device driver, or the use of an improper version of a device driver, are the most common causes of calls to Plextor's Technical Support Department.

If you use a PC, your primary source for the version of the device driver you require should be the company which is the manufacturer of the SCSI interface board you are using (i.e., if you have a Future Domain board, you should get your device driver from Future Domain; if you have an Adaptec board, you should get your device driver from Adaptec).

Apple computer users typically purchase the device driver they require separately, or find it bundled with their CD-ROM drive at the time of purchase.

For PC users, the fact that you own a SCSI interface board does not guarantee that you will be able to use it with Plextor's CD-ROM drive. Some SCSI interface board manufacturers do not offer device drivers for CD-ROM drives, or make them extremely difficult to get (this is becoming increasingly rare, but it does still happen). If you question whether your SCSI interface board can work with Plextor's drive, call our Technical Support Department and ask for a copy of our SCSI Interface Board Compatibility Guide.



A more common problem is that the CD-ROM drivers which you received with your SCSI interface board at the time of purchase need to be updated in order to work with your 4PleX drive. SCSI interface board manufacturers are continuously updating their device drivers to provide support for new SCSI peripherals as they enter the market. Most of these companies will provide you updated drivers at little or no cost. In addition, if you have a modem, you can call the bulletin board that many of these companies maintain and download the most recent version of their drivers (see page 65 for a listing of BBS numbers). Please contact Plextor's Technical Support Depart-

ment if you need help in finding the proper device drivers for use with your SCSI interface board.

Another source of device drivers for your CD-ROM drive is the growing number of ASPI driver programs such as Future Domain's POWER SCSI, Adaptec's EZ- SCSI and Corel's Corel SCSI. These drivers are sold in retail packaging at many computer stores. If your SCSI interface board manufacturer provided you with an ASPI Manager (which comes on a floppy disk; most boards shipped in recent years included one) at the time of purchase, you can make use of an ASPI driver. In addition to CD-ROM drivers, these programs typically include drivers for many other SCSI peripherals (hard disks, WORM drives, MO drives, scanners, etc.) as well as several useful software utilities.

Below we have provided as examples the device driver installation sequence for a common SCSI interface board (Future Domain TMC-1610) and a popular Mac CD-ROM device driver (FWB). If you are installing another type of device driver, your installation sequence probably will be different. The manual that came with your SCSI interface board or Mac CD-ROM device driver contains detailed instructions for performing the driver installation. Unless you have performed this procedure before, you should refer to that manual for step-by-step instructions.

Before starting this section, check that all the cable connections between your CD-ROM drive and PC or Mac are correct, and that all switches, dials and terminators are set properly. If you are using a PX-45CH external drive, turn its power switch OFF.

FUTURE DOMAIN TMC-1610M Quick Start Installation Procedure

NOTE: These instructions pertain only to TMC-1610M boards that are purchased in the same box as a 4PleX drive. If you purchase a TMC-1610 board separately, your instructions may differ slightly.

You can find complete instructions and a troubleshooting guide in the "Multimedia and CD-ROM Software" manual that is included with the TMC-1610M boards that Plextor ships.

- 1) Open the package and verify that all the components are included. The "READ ME FIRST" sheet included in the package will list the components you should find.
- 2) The TMC-1610M default configuration uses interrupt (IRQ) 11. This setting is usually available. If you know of a conflict, you should change the board now to another setting. If you have no idea what we are talking about,

chances are that you aren't using interrupt 11, and you can proceed confidently to step #3.

- 3) If you haven't already installed your board, select an available 16-bit slot and insert the TMC-1610M board there (see page 21 for directions on how to install a board in your computer).
- 4) If you are using an internal drive, use a SCSI ribbon cable to connect your board to your drive. **BE CAREFUL** to align the red stripe on the cable to Pin 1 of both the card and drive (see caution note on page 27). If you are using an external drive, use a standard external SCSI cable to connect your board to your drive.
- 5) Locate the floppy disk labeled "Multimedia and CD-ROM Software for Plextor" and insert it into your floppy disk drive.
- 6) The "Setup" program on the disk can be run under DOS or Windows.

DOS USERS: Change to the floppy disk drive in which you inserted the "Multimedia and CD-ROM Software for Plextor" disk (e.g., type "A: <return>"). Then type "Setup <return>".

WINDOWS USERS: From the Program Manager, pull down the FILE menu. Choose RUN. Type "A: Setup" in the Command Line field. Click OK.

- 7) The Future Domain installation program will now begin. It will ask if you want to run an Express or Custom setup. Select Express, then accept the default settings on the menus that follow. After you have completed this sequence, you need to reboot your computer. You should now be able to access your 4PleX CD-ROM drive as the next available drive letter (i.e., if your hard disk is c:> and you have no other peripherals connected to your computer, your 4PleX drive should now be available as drive d:>).

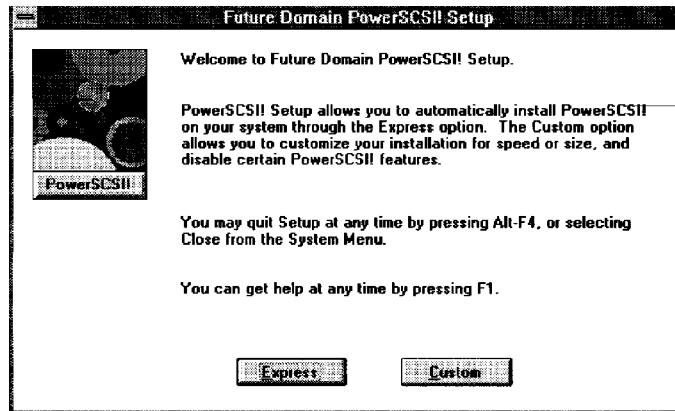

FWB Toolkit Macintosh Device Driver Installation



- 1) To begin installation, insert the FWB floppy disk into your disk drive. Make sure that power to your CD-ROM drive is OFF.

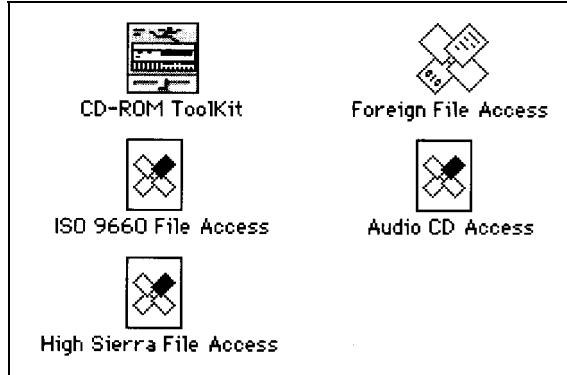

- 2) Drag each icon from the driver window into your SYSTEM FOLDER.

SYSTEM 7 USERS: At this point a dialog box will appear telling you that these files need to be stored in special places in the SYSTEM FOLDER. Click on OK and all the files will be copied to their appropriate places.

SYSTEM 6 USERS: All files already are where they need to be. No further commands are necessary.

- 3) Turn OFF the power to your Mac. Turn ON the power to your CD-ROM drive, then turn ON power once again to your Mac.
- 4) Insert a caddy containing a CD-ROM disc (written in Mac format) into your 4PleX drive.
- 5) Your Mac will display the CD-ROM disc's icon.
- 6) Double click on the icon to start the program.

Special Operating System Notes

NOTE: The following section pertains only to PC users who use IBM'S OS/2 operating system.



OS/2

YOUR TASK: Install OS/2 from your CD-ROM drive. Or, if you already have installed OS/2, add CD-ROM support.

YOUR OBJECTIVE: Utilize full capabilities of OS/2 on your computer.

YOUR METHOD: Check to see if your SCSI interface board is included on OS/2's list of supported hardware. Follow IBM's installation instructions.

Installation Procedure

To install OS/2 2.1x from your OS/2 CD-ROM disk, you first need to verify that your SCSI interface board is supported by OS/2. Check your OS/2 manual, and the README file on the floppy disk that comes with the OS/2 CD-ROM, for information on which SCSI interface boards OS/2 supports.

If your SCSI interface board is on OS/2's list of supported hardware, you can follow the installation instructions provided by IBM.

However, if your SCSI interface board is not on OS/2's list of supported hardware, you must contact the manufacturer of your board and request an OS/2 software device driver. (See listing of key contact phone/fax/bbs numbers on page 65.)

The OS/2 device driver files that you need from your SCSI interface board's manufacturer end with an ".ADD" extension. They need to be copied into the CONFIG.SYS file on the OS/2 installation floppy disk. Your SCSI interface board manufacturer will provide you with specific instructions.

NOTE: During the OS/2 installation procedure you will be presented with a list entitled "Installed Hardware." Do not change the settings that appear for "SCSI Host Adapter" or "CD-ROM Drive." If you change these settings, or even if you select and deselect them without changing them, CD-ROM support will not be loaded correctly onto your computer. After you reboot, your CD-ROM drive still will not appear in the "Drives" folder. This is a bug that may be fixed in a future version of OS/2.



Adding CD-ROM Support After OS/2 Has Already Been Installed

- 1) You first need to verify that your SCSI interface board is supported by OS/2. Check your OS/2 manual, and the README file on the floppy disk that comes with the OS/2 CD-ROM, for information on which SCSI interface boards OS/2 supports. If your SCSI interface board is included on the list of supported hardware, you can skip to step #3.
- 2) If your SCSI interface board is not on OS/2's list of supported hardware, you must contact the manufacturer of your board and request an OS/2 software device driver. (See listing of key contact phone/fax/bbs numbers on page 65.)
- 3) Once you have confirmed that your SCSI interface board is supported by OS/2, or you have obtained the necessary device driver files, run OS/2's Selective Install program to set up your SCSI interface board and CD-ROM drive. In the "SCSI Host" field, select your board. (If your board already was installed and running, your SCSI interface board should already be selected, and there is no need for you to change this entry.) In the "CD-ROM Drive" field, select "Texel 3024/5024" or "Texel 3028/5028." Then, select "Install" and insert the OS/2 floppy disks when requested. After rebooting, your CD-ROM drive should appear in the "Drives" folder.

OS/2 2.x Troubleshooting Tip:

If you have difficulty getting OS/2 to recognize your CD-ROM drive and SCSI interface board, you first should verify that all of your hardware is operating properly.

This is best done by installing DOS. If your system also does not work under DOS, you probably have a hardware problem that needs to be resolved before you can go any further. Refer to the Troubleshooting guide in Chapter 13. If your system works under DOS, but not OS/2, review your device driver installation and verify that the SCSI interface board driver and CD-ROM support (step #3, above) is loaded correctly.

NOTE: The following section pertains only to PC users who use Microsoft's Windows NT Operating System.



Windows NT 3.1

YOUR TASK: Install Windows NT from your CD-ROM drive. Or, if you already have installed NT, add CD-ROM support.

YOUR OBJECTIVE: Utilize full capabilities of NT on your computer.

YOUR METHOD: Check to see if your SCSI interface board is included on NT's list of supported hardware. Follow Microsoft's installation instructions.

Installation Procedure

To install Windows NT from your NT CD-ROM disc, you first need to verify that your SCSI interface board is supported by NT. Check your NT manual for information on which SCSI interface boards NT supports.

If your SCSI interface board is on NT's list of supported hardware, you can follow the installation instructions provided by Microsoft.

However, if your SCSI interface board is not on NT's list of supported hardware, you must contact your board's manufacturer and request a NT software device driver (see listing of key contact phone/fax/bbs numbers on page 65).

The files you obtain need to be added to the NT installation floppy disk(s) that came with your NT CD-ROM disc. Your SCSI interface board manufacturer will provide you with specific installation instructions.

Adding CD-ROM Support After NT Has Already Been Installed

- 1) You first need to verify that your SCSI interface board is supported by NT. Check your NT manual for information on which SCSI interface boards NT supports. If your SCSI interface board is included on the list of supported hardware, skip to #3.
- 2) If your SCSI interface board is not on NT's list of supported hardware, you must contact your board's manufacturer and request a NT software device driver (see listing of key contact phone/fax/bbs numbers on page 65).

- 3) Run NT's Setup program to add support for your SCSI interface board. Select "Add/Remove SCSI Adapters . . ." from the menu. Choose your SCSI interface board from the list or, alternately, add the driver you obtained from your SCSI interface board manufacturer.
- 4) Run the NT Control Panel and then run Devices. From the list of devices, locate "Scsidrom" and check the "startable" box. This procedure is fully outlined in the Windows NT manual.
- 5) Reboot. Your 4PleX drive now should be visible to the system.

Windows NT 3.1 Troubleshooting Tip

If you have difficulty getting NT to recognize your CD-ROM drive and SCSI interface board, you first should verify that all of your hardware is operating properly.

This is best done by installing DOS. If your system also does not work under DOS, you probably have a hardware problem that needs to be resolved before you can go any further. If your system works under DOS, but not NT, review your device driver installation and verify that the SCSI interface board device driver and CD-ROM support (step #4, above) are loaded correctly.

Using CD-ROM Discs and Caddies



YOUR TASK: Learn how to use a caddy and how to handle and care for your discs.

YOUR OBJECTIVE: Protect your discs. Insert and eject caddies properly so your drive operates without interruption.

YOUR METHOD: Practice loading discs into caddies, and caddies into drives.

Plextor's CD-ROM drives use an industry-standard disc caddy to protect the disc from scratches and contamination. A standard caddy is made of plastic and has a metal shutter on its bottom which slides open and shut. Use of a non-standard caddy (e.g., one which lacks a metal shutter on its bottom) is not recommended. For their protection, CD-ROM discs should be stored in their original packaging or in a caddy.

Inserting the Disc into a Caddy

- 1) To open the lid of the caddy, press the tabs at the side as shown.



- 2) Place the disc into the caddy with the label facing UP. Be sure to place the disc beneath the edge of the caddy under the arrow mark. Handle the disc by the sides. Don't touch its surface.

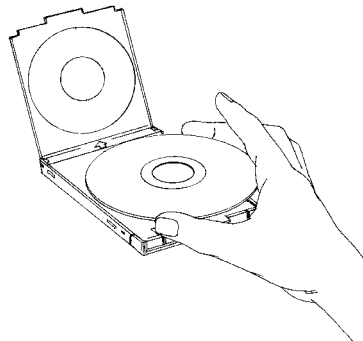

- 3) Close the lid firmly. But not too hard.

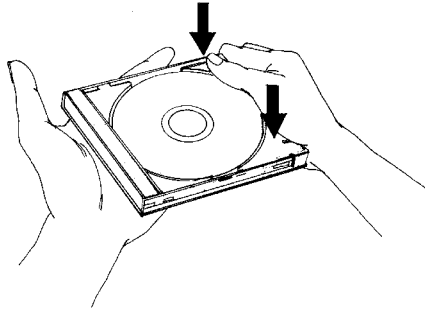

Caution: If the caddy appears defective (e.g., warped, cracked, or bent) do not insert it into the drive. A defective caddy can become stuck inside the drive, requiring the drive's return to your dealer for service. If your caddy appears defective, promptly replace it with a new one.

Handle the caddy as you would any precision component. **Do not:**

- X Allow moisture or dust/contamination either in or on the caddy.
- X Store the caddy in a location subject to direct sunlight, high temperature, or high humidity.
- X Drop the caddy or subject it to shock.
- X Open the shutter manually. The caddy's shutter opens automatically when the caddy is inserted into the CD-ROM drive.

Loading the Caddy into the Drive

1. Open the drive's door.
2. Carefully insert the caddy in the direction shown, with the arrow mark facing the drive.
3. Push the caddy into the drive until the caddy drops into place.

Hint: You need use only one hand to insert the caddy into the drive. This is easily accomplished by placing the front portion of the caddy on top of the lip of the drive's door. You can press down lightly to open the drive's door, then slide the caddy into the drive.

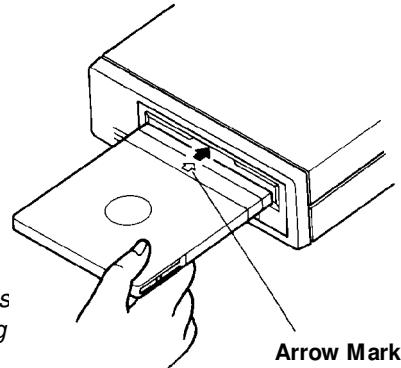

Removing the Caddy from the Drive

- 1) Push the Eject button. The caddy will eject from the drive in 2–3 seconds.
- 2) Pull the caddy straight out of the drive.
- 3) If the caddy will not eject from the drive after pushing the eject button, you should be able to remove the caddy from the drive by using the Emergency Eject button. Turn off power to the drive. Insert a paper clip into the Emergency Eject hole. The caddy should now eject from the drive. Please contact Plextor's Technical Support Department before attempting to reinsert the caddy into the drive.

Cleaning the Disc

If the disc is merely dusty, you may use a commercially available dust removal spray such as Dust-Off or Vari-Air to blow dust particles off the disc.

After removing the dust particles, you may wipe the disc using a clean soft cotton cloth. Use a straight-line motion, wiping *from the center out*. Do *not* wipe the disc in a circular motion.

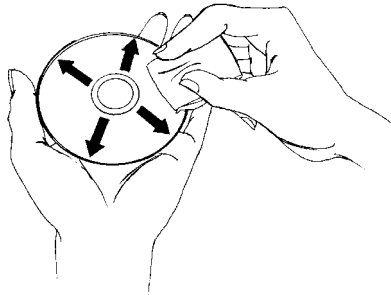

If a disc becomes dirty or soiled with grease or other contaminants not removable by wiping, you may clean the disc with a CD-ROM disc cleaner available at most computer dealers. Follow the directions packaged with the cleaner.

Hint: Keeping your CD-ROM disc in a caddy at all times will prevent the disc from becoming dirty or damaged.

How to Play Music CDs on your Drive



YOUR TASK: Learn how to use your CD-ROM drive so that it can also play music CDs.

YOUR OBJECTIVE: Increase functionality of your drive. Provide musical accompaniment for presentations. Goof off at work.

YOUR METHOD: A variety exists for you to choose from. You can use anything from very basic, bare bones music CD software utilities up to software utilities which rival or surpass the capabilities of the CD player attached to your stereo system.

- 1) The most basic method is to put your CD-ROM drive in Music CD Player Mode. To do so, first make sure that power to your drive is turned on. No drivers need to be loaded for the drive to operate in Music CD Player Mode.

With no CD in the drive, press and hold the eject button for 5-10 seconds. The on/busy light will blink rapidly for a moment confirming that your drive is now in Music CD Player mode. If you insert a CD into a caddy, then insert the caddy into the drive, the drive will begin to play music from the disc's first track. To skip to the next track, quickly press the drive's eject button. To eject the caddy from the drive, press and hold the Eject button until the CD ejects.

To leave Music CD Player Mode, simply insert a data CD into your CD-ROM drive.

- 2) If you are a PC owner running Windows, you can use the Media Player found in the Accessories group. To do so you must first load the [MCI] CD Audio driver. Find the disks on which you received Windows, then follow these steps:
 - a) Insert a music CD into your CD-ROM drive.
 - b) In Windows, select "Program Manager".
 - c) In "Program Manager," select the "Main" group.
 - d) In the "Main" group, select "Control Panel."
 - e) In "Control Panel," select "Drivers."

- f) Select “Add. . .”
- g) Move the highlight bar down to “[MCI] CD Audio.”
- h) Select “OK.”

You then will be instructed to insert one of your Windows disks into your floppy drive. After loading the proper device driver, Windows should send you the message, “One CD-ROM drive detected. Installation complete.” If this step fails, verify that the CD-ROM drive is operating properly.

Once the driver is successfully loaded, you can run Media Player in your Accessories group. Select Media Player, then pull down the menu under the DEVICE heading and select “CD Audio.” You now can use Media Player’s basic controls to play music CDs on your CD-ROM drive.

- 3) If you are a PC owner and want greater functionality than what Media Player can provide, you can use a program such as Animotion’s MCS CD Master (which usually comes bundled with Future Domain SCSI interface boards), CD Player (which usually comes bundled with Adaptec SCSI interface boards), or CD Audio (which is part of the Corel SCSI software package). These utilities allow you to control your CD-ROM drive much like a fully featured audio CD player (e.g., you can program tracks, fast-forward, see the length of each track in minutes and seconds, etc.).



- 4) Mac users can run a program such as CDT Remote (which typically is included with FWB’s CD-ROM device driver) or Music Box (which typically is included with Trantor’s CD-ROM device driver).

In order to hear the music CD your drive is playing, you can plug a pair of stereo headphones or self-powered speakers into the stereo mini-jack on the drive’s front panel. You also can connect your drive to an audio amplifier as shown on the next page.

PLEASE NOTE: The volume control wheel on the front panel of your drive adjusts only the sound level of the headphone jack. It has no impact on the volume level of the rear panel audio outputs.

PX-43CH

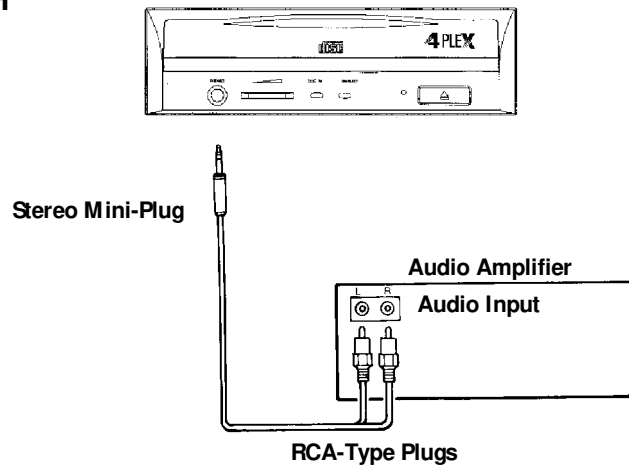

PX-45CH

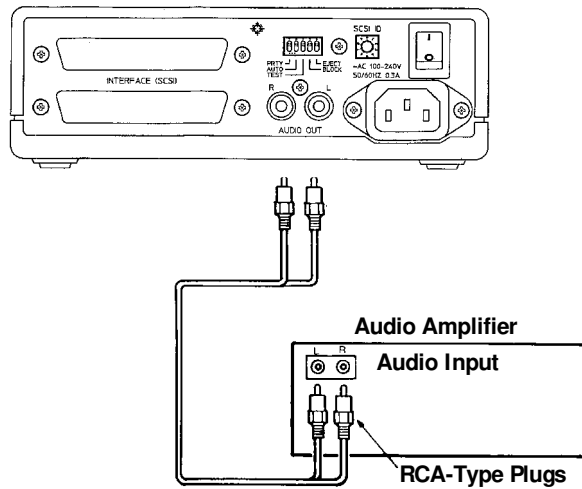



Troubleshooting

YOUR TASK: Review some of the common problems you may encounter when installing or operating your 4PleX drive.

YOUR OBJECTIVE: Gain a better understanding of how your drive operates. Attempt to prevent problems before they occur. Quickly fix, on your own, many simple problems rather than wait for assistance from a Pextor representative.

YOUR METHOD: Read this entire section. Many of the problems discussed happen only rarely. Many may seem as if they do not pertain to you. However, if you are familiar with the variety of problems that can occur, you will be better prepared to deal with them if they happen to you. 

If you experience trouble with your 4PleX drive, follow these guidelines:

PC Users:

- 1) Most SCSI interface boards can sense when a problem has occurred and will generate an error message on your computer. Take note of this message. Then, run the test (diagnostic) program that probably is included with the device drivers for your SCSI interface board. Follow the instructions given in the SCSI interface board's manual. If the information provided by the error message and test program is not sufficient for you to fix the problem, proceed to step #2.
- 2) If your problem occurs during or immediately after the drive's installation, read Section 13.1 – PCs: Initial Installation. If your problem occurs after you had run the drive successfully for an extended period, read Section 13.2 — PCs: Existing Installations.
- 3) Attempt to match the problem you are having with the entries listed beneath SYMPTOMS. Then narrow your search by checking to see if the ADDITIONAL SYMPTOMS apply to you, as well. Because different SCSI interface boards generate differently worded error messages, the messages displayed by your computer may differ from those shown on the following pages.

Apple Computer Users:

Read Section 13.3 — Apple Computers



Technical Support

If you still cannot solve your problem after reviewing the relevant sections of this chapter, please contact Plextor's Technical Support Department. See Chapter 14 for information on how to prepare for, and then make contact with, Plextor's Technical Support staff.

13.1 IBM Compatibles: Initial Installation

Symptoms

- No sound when running a CD-ROM program

Additional Symptom

No sound when playing a music CD

Possible Causes and Solutions

Application does not use CD-Audio

There are two types of audio you may encounter when using CD-ROMs:

1) Sound Card Audio:

This comes from data (e.g., .WAV or .MID files) which is transferred from your CD-ROM disc, into your computer, and is translated by your soundboard into sound. If you do not have a soundboard, you will not be able to hear this form of audio.

2) CD Audio:

This comes from data that is translated directly by your CD-ROM drive into sound. You do not need a soundboard to hear this audio. You can hear this audio by plugging a set of headphones or powered speakers into the audio jack on the front of your drive.

One reason, then, that you might not hear sound when playing a CD-ROM disc is that a soundboard is required. These discs use only sound card audio, not CD audio.

To help you determine if you are having a soundboard problem, or a CD Audio problem, try playing a music CD in your CD-ROM drive. If you can hear music (through headphones or speakers connected to the audio jack on the front of your drive), the CD-ROM disc you had played may require the use of a soundboard in order to hear sound. If possible, check the manual that came with the CD-ROM disc and see if the use of a soundboard is recommended or required.

If you have a soundboard, can hear a music CD when it is played, but cannot hear sound when you play a CD-ROM disc, you may have configured your soundboard incorrectly. Check the troubleshooting section of your soundboard manual for further advice. If you have a soundboard but you cannot hear a music CD when it is played, check the following points:

Improper/missing audio cable

If you use a soundboard, you must connect the soundboard to your CD-ROM drive with an audio cable. See page 33 to ensure you have properly installed this audio

cable. If you have a soundboard and CD-ROM drive, but lack an audio cable, contact one of the companies listed on page 65, or Plextor's Technical Support Department, for information on where a cable can be purchased.

Device drivers need to be updated

If you can hear a music CD in your CD-ROM drive when it is in Music CD Player mode (see Chapter 12), but you cannot hear a music CD with another music CD utility (e.g., Animate's MCSCD Master, Trantor's MusicBox, Corel CD), your device drivers may need to be updated. Contact your SCSI interface board or soundboard manufacturer and verify that their device drivers fully support your 4PleX drive. If they do not, installing "universal" drivers such as those supplied in Corel SCSI may fix this problem.

Soundboard volume low

If when playing a music CD you do not hear sound even though everything appears to be functioning normally (busy light on drive flickers, the time counter on your audio CD utility is advancing), you may have the mixer settings for your soundboard set too low. Each soundboard has different settings for each input source, including one for CD Audio. Run your soundboard's mixer program and verify that the volume is turned up.

Bad soundboard audio cable

If you have verified that you have made the proper cable connections between your 4PleX drive and soundboard, and you have the correct device drivers installed, but you still do not hear sound when playing a music CD, the problem may rest with your audio cable. It may be defective and need to be replaced.

You can check to see if this is the case by doing the following: unplug the audio cable from the rear of your 4PleX drive. Plug a set of headphones or speakers that you know are good into the jack on the front of the drive. Try to play a music CD. If you now can hear music, you can conclude that you do, in fact, have a bad audio cable.

Symptoms

- Cannot view Photo CD discs
- Can read only first session of a multisession disc
- Receive error messages while reading Photo CD images

Your 4PleX drive is capable of reading Kodak Photo CD multisession discs if you use the appropriate device drivers, and you run a Photo CD viewing program (e.g., Magic Lantern, Kodak's Photo CD Access).

Possible Causes and Solutions

Device drivers need to be updated

Contact your SCSI interface board/soundboard manufacturer and verify that the device drivers you have support your 4PleX drive. If they do not, you may be able to utilize “universal” device drivers, such as those included in CorelSCSI, in order to view multisession discs.

Bad Photo CD disc

If you can see a list of files from your Photo CD (after issuing a DIR command), but cannot read them, or experience errors while reading them, you may have a bad Photo CD disc. Try another Photo CD disc. If it works, you should have the defective disc replaced.

Symptoms

- Invalid Drive Specification
- No Device Found
- No SCSI Interface Board Found or No Response from SCSI Interface Board
- No Drives in Use

Additional Symptom

Error Appears upon Initial Installation of the CD-ROM Drive and Device Driver Software

Possible Causes and Solutions

Improper SCSI Device Driver Installation

Your computer needs a SCSI software device driver to link the SCSI interface board to the CD-ROM drive. If this driver cannot be loaded properly, an error message will normally be displayed on the screen.

Try rebooting the computer. Watch as the CONFIG.SYS file executes and look for an error message to appear. You can press the Control and S keys simultaneously to freeze the display in order to read the error message (use the Control and S combination again to continue).

If the SCSI device driver cannot be loaded properly, either a software or hardware conflict exists. Software conflicts are generally caused by memory managers; hardware conflicts by two peripherals vying for the same DOS address space. Please read the next two paragraphs on software and hardware conflicts.

Software Conflict with Other Device Drivers

The SCSI interface board normally designates the CD-ROM driver as the first device driver loaded by the computer. When the computer has a memory manager (e.g.,

HIMEM.SYS, 386MAX.SYS or QEMM.SYS), in most cases the memory manager is loaded first and the CD-ROM driver loaded directly thereafter.

If other device drivers are loading before the CD-ROM driver, place them after the CD-ROM driver. If the memory manager tries to load the CD-ROM driver into high memory (e.g., DEVICEHIGH or LOADHIGH), disable the function so that the driver is loaded into conventional memory.

Hardware Conflict Between the Interface Board and Your Computer

The SCSI interface board may be in conflict with another peripheral in your computer. Normally, this conflict can be settled by selecting a different address for the SCSI interface board. In some cases, you may wish to select a different address for the conflicting peripheral.

If the driver still does not recognize the interface board, follow these steps:

- 1) Remove all non-essential peripherals from your computer (e.g., network boards, fax boards, etc.) and their device drivers from the CONFIG.SYS and AUTOEXEC.BAT files.
- 2) Reboot the computer and ensure that the CD-ROM device driver recognizes the SCSI interface board.
- 3) Turn off the computer and reinstall each peripheral and its device drivers one at a time.
- 4) Repeat steps 2 and 3 until the problem reoccurs.

Improper MSCDEX Installation

The Microsoft CD-ROM Extensions (filename: MSCDEX.EXE) are required to run your CD-ROM drive under MS-DOS or DRDOS. If the SCSI driver was successfully loaded, check for proper installation of MSCDEX.EXE by rebooting the computer and watching the AUTOEXEC.BAT file as it executes for an error message.

SCSI Interface Board Not Properly Seated

If the SCSI interface board is not fully seated into the computer's expansion slot, the device driver software will not recognize it. Inspect the interface board where it seats into the connector on your computer's motherboard. There should not be more than a small gap between the interface board and the connector.

Symptom

- Incorrect DOS Version
-

Possible Causes and Solutions

Conflict between MS-DOS 5.0 and Microsoft's CD-ROM Extensions Version 2.2 or lower

MS-DOS 5.0 users should use Microsoft's CD-ROM Extensions (file name MSCDEX.EXE) Version 2.21 or 2.22. If you do not have either of these versions, and plan to use DOS 5.0 with MSCDEX.EXE Ver 2.2 (or lower), you can resolve this conflict by doing the following:

- 1) Type the following line into your CONFIG.SYS file:
DEVICE=C:\DOS\SETVER.EXE
- 2) Switch to the DOS prompt.
- 3) Type the following: SETVER MSCDEX.EXE 4.01, then press the enter key.
- 4) Reboot your computer.

Conflict between MS-DOS 6.0 and Microsoft's CD-ROM Extensions (file name: MSCDEX.EXE) Version 2.21 or lower

MSCDEX.EXE ver. 2.22 (or higher) must be used with DOS 6.0. Use of an earlier version will result in an INCORRECT DOS VERSION message. A copy of MSCDEX.EXE ver. 2.22 is included with DOS 6.0. You can find this file in your C:\DOS directory.

If you previously had loaded MSCDEX.EXE ver. 2.21 (or lower), your computer might still be recognizing this lower version rather than 2.22 (or higher).

To correct this problem, you must edit your AUTOEXEC.BAT file using a text editor or word processor. Your AUTOEXEC.BAT file will probably contain a line that looks something like this:

```
C:\TSCSI\MSCDEX.EXE/D:TSLCD /M:10
```

In this example, "C:\TSCI" is the path to MSCDEX.EXE. The path name will vary depending on the type of SCSI device driver software you use.

Change only the path of this line in your AUTOEXEC.BAT file so that it finds the updated MSCDEX.EXE file in your DOS directory. This line should be edited to read:

```
C:\DOS\MSCDEX.EXE/D:TSLCD /M:10
```

Save the AUTOEXEC.BAT file and reboot your computer.

Symptoms

- No Device Found
- No SCSI Interface Board Found or No Response from SCSI Interface Board

Additional Symptom

Driver Fails to Recognize the SCSI Interface Board

Possible Cause and Solution**Drive In Check Condition**

In some cases, even if you restart the computer by pressing its reset button or the Control, Alt and Del keys simultaneously, the drive does not respond to an inquiry. Try turning the power switches on the drive and computer OFF, then ON. This complete shutdown should fully reset the drive and computer.

Symptom

- CDR101 – Not Ready Reading Drive [X]

Additional Symptom

All Commands Sent to the Drive Result in CDR101 Error

Possible Causes and Solutions**Defective caddy**

A warped or damaged caddy can cause a CDR 101 error message. Try using another caddy and see if this eliminates the problem. Also, be sure to use only an “industry standard” caddy. This is a caddy made of plastic with a metal shutter on its bottom. If you use another type of caddy (e.g., all plastic, but with no metal shutter on its bottom — just an opening), you may experience problems.

Defective CD-ROM Disc

A fingerprint or other contaminants or deep scratches on the disc’s surface may prevent the drive from reading data. Read Chapter 11 to learn how to clean CD-ROM discs.

If the problem persists, try setting the AUTO switch OFF. This setting reduces the data transfer rate to 150 KB/sec, making it possible to read some marginal data. Normally the transfer rate is 600 KB/sec for the data region of the disc and 150 KB/sec for the audio region. Always turn the drive OFF before changing the setting of the rear-panel switches.

Bad Connection Between the CD-ROM Drive and the SCSI Interface Board

Inspect the cable, drive, and interface board for recessed, broken or bent pins. If a ribbon cable is used, inspect for any signs of distress, such as kinking. Ensure the red stripe side of the ribbon cable plugs into pin 1 on both the drive and the interface board.

Audio CD Disc In the Drive

Plexor CD-ROM drives are capable of playing high-quality audio when used with appropriate audio playback software, or when the drive is set to Music CD Player Mode (see Chapter 12). However, since audio compact discs do not have computer data, typing computer commands while an audio CD is in your drive will result in an error message.

Disc in Caddy Upside Down

Remove disc from caddy and reinsert label side up.

13.2 IBM Compatibles: Existing Installations

Symptoms

- Invalid Drive Specification
- No Device Found
- Drive Not Responding

Additional Symptom

Interface Board Driver Fails to Recognize the CD-ROM Drive

Possible Causes and Solutions

Drive is Not On

If you have a PX-45CH external drive, check that its rear-panel power switch is ON. If the drive is the PX-43CH internal model, ensure the power cord from your computer's power supply is plugged firmly into the drive power connector.

Bad Connection Between the CD-ROM Drive and the SCSI Interface Board

Inspect the cable, drive, and interface board for recessed, broken or bent pins. If a ribbon cable is used, inspect for any signs of distress, such as kinking. Ensure the red stripe side of the ribbon cable plugs into pin 1 on both the drive and the interface board.

Improper SCSI Bus Termination

Ensure that only the last peripheral on the SCSI bus is terminated (see Chapter 7). Some peripherals have a setting marked "termination power" instead of "terminator". Ensure their termination power switches are set correctly.

Symptom

- CDR 101 – Not Ready Reading Drive [X]

Additional Symptom

CD-ROM Drive Responds to Directory (DIR) Command But Cannot Run a Program

Possible Causes and Solutions**Bad Connection Between the CD-ROM Drive and the SCSI Interface Board**

Inspect the cable, drive, and interface board for recessed, broken or bent pins. If a ribbon cable is used, inspect for any signs of distress, such as kinking. Ensure the red stripe side of the ribbon plugs into pin 1 on both the drive and the interface board.

Improper SCSI Bus Termination

Ensure that only the last peripheral on the SCSI bus is terminated (see Chapter 7). Some peripherals have a setting marked “termination power” instead of “terminator”. Ensure their termination power switches are set correctly.

Defective CD-ROM Disc

A fingerprint or other contaminants or deep scratches on the disc’s surface may prevent the drive from reading data. Read Chapter 11 to learn how to clean CD-ROM discs.

If the problem persists, try setting the AUTO switch OFF. This setting reduces the data transfer rate to 150 KB/sec, making it possible to read some marginal data. Normally the transfer rate is 600 KB/sec for the data region of the disc and 150 KB/sec for the audio region. Always turn the drive OFF before changing the setting of the rear panel switches.

Conflict With a Network Card

Temporarily remove the network card and all related drivers from the AUTOEXEC.BAT and CONFIG.SYS files. Reboot the computer and check that the CD-ROM drivers load successfully.

Conflict with DOS 5.0 EMM386.EXE

The DOS memory manager may be using the address area required by the interface board. (This situation does not apply to interface boards that do not use high memory addressing, such as the Trantor’s T-130b/T-160.) If you suspect this problem, edit your CONFIG.SYS file as follows:

Before: DEVICE=C:\DOS\EMM386.SYS

After: DEVICE=C:\DOS\EMM386.EXE X=CA00-EC00

The X=CA00-EC00 argument prevents EMM386.SYS from using the address space required by the interface board.

Caddy Has Not Dropped Into Place

Eject the caddy and re-insert, ensuring it drops into the drive. If the caddy is defective, replace it.

Symptom

- CDR 101 – Not Ready Reading Drive [X]

Additional Symptom

Errors Occur Intermittently

Possible Causes and Solutions

Defective CD-ROM Disc

A fingerprint or other contaminants or deep scratches on the disc's surface may prevent the drive from reading data. Read Chapter 11 to learn how to clean CD-ROM discs.

If the problem persists, try setting the AUTO switch OFF. This setting reduces the data transfer rate to 150KB/sec, making it possible to read some marginal data. Normally the transfer rate is 600KB/sec for the data region of the disc and 150KB/sec for the audio region. Always turn the drive OFF before changing the setting of the rear-panel switches.

Drive Not Terminated

If your CD-ROM drive is the only SCSI peripheral attached to your computer or is the last SCSI peripheral in a daisy chain (i.e., along a cable connecting multiple SCSI peripherals to a single SCSI interface board), check that its termination switch is ON. Always turn the drive OFF before changing the setting of the rear-panel switches.

Symptom

- CDR101 – Not Ready Reading Drive [X]

Additional Symptom

All Commands Sent to the Drive Result in CDR101 Error

Possible Causes and Solutions

Defective CD-ROM Disc

A fingerprint or other contaminants or deep scratches on the disc's surface may prevent the drive from reading data. Read Chapter 11 to learn how to clean CD-ROM discs.

If the problem persists, try setting the AUTO switch OFF. This setting reduces the data transfer rate to 150 KB/sec, making it possible to read some marginal data. Normally the transfer rate is 600 KB/sec for the data region of the disc and 150 KB/sec for the audio region. Always turn the drive OFF before changing the setting of the rear-panel switches.

Bad Connection Between the CD-ROM Drive and the SCSI Interface Board

Inspect the cable, drive, and interface card for recessed, broken or bent pins. If a ribbon cable is used, inspect for any signs of distress, such as kinking. Ensure the red stripe side of the ribbon cable plugs into pin 1 on both the drive and the interface board.

Audio CD Disc In the Drive

Plexor CD-ROM drives are capable of playing high-quality audio when used with appropriate audio playback software or when the drive is set to Music CD Player Mode (see Chapter 12). However, since audio compact discs do not have computer data, typing standard data commands when an audio CD is in the drive will result in an error message.

Disc in Caddy Upside Down

Remove disc from caddy and reinsert label side up.

Symptom

- CDR103 – Not High Serra Format

Additional Symptom

Occurs With Certain Discs Only

Possible Cause and Solution

Incorrect Disc

The disc might be intended for another type of computer, such as a Macintosh or Sun, or it is not mastered in the High Serra or ISO 9660 formats.

Symptom	Additional Symptom
<ul style="list-style-type: none"> • CDR103 – Not High Serra Format 	Occurs Regardless of the Discs Used

Possible Causes and Solutions

Hardware Conflict

If the SCSI interface board uses DMA channels, try changing the selected DMA channel. Valid settings are normally Channel 1 or Channel 3. See the instruction manual for your SCSI interface board.

Memory Manager Conflict

If the SCSI interface board uses memory-mapped addressing, exclude the addresses from the memory manager. See the instruction manual for your SCSI interface board.

Incorrect Version of Microsoft CD-ROM Extensions

Version 2.00 or higher of MSCDEX is required to read a High Serra or ISO 9660 format disc.

Symptom	Additional Symptom
<ul style="list-style-type: none"> • Excessive Noise • Disc Heard Jumping 	CDR101 Error Message

Possible Causes and Solutions

Defective Caddy

Replace caddy.

Defective CD-ROM Disc

A fingerprint or other contaminants or deep scratches on the disc's surface may prevent the drive from reading data. See Chapter 11 to learn how to clean CD-ROM discs.

If the problem persists, try setting the AUTO switch OFF. This setting reduces the data transfer rate to 150KB/sec, making it possible to read some marginal data. Normally the transfer rate is 600KB/sec for the data region of the disc and 150KB/sec for the audio region. Always turn the drive OFF before changing the setting of the switches.

CD-ROM Drive Set to Test Mode

Turn this switch OFF. The test mode is for factory use only. Always turn the drive OFF before changing the setting of the switches.

Symptom

- Low Performance of CD-ROM Application Software

Possible Cause and Solution

Drive Automatically Set to Standard Throughput (150KB/sec)

Plextor's drives are designed to automatically switch from quad speed throughput (600KB/sec) to double (300KB/sec) and then single (150KB/sec) speed when they encounter a defective, damaged or poorly manufactured disc. The drive then will continue to read data from the disk at double or single speed until a new read command is transmitted to the drive. The drive will then attempt to return to quad speed mode.



13.3 Apple Macintosh

Symptoms

- Invalid Drive Specification
 - No Device Found
 - Drive Not Responding
-

Possible Cause and Solution

SCSI Address Conflicts with the Hard Disk Drive

This usually can be corrected by selecting another SCSI address (normally addresses 1 to 6) for your CD-ROM drive. Note: the Macintosh's hard disk uses address 0 and its internal SCSI adapter uses address 7.

Symptom

- Computer Does Not Respond
-

Possible Cause and Solution

INIT Conflicts

Remove all INITs except those from your System Folder and the ones copied from the CD-ROM device driver disk. If the CD-ROM drive functions correctly, reinstall the INITs one at a time, restarting the Macintosh after each one, until the problem is solved.

Symptom

- Low Performance of CD-ROM Application Software
-

Possible Cause and Solution

System Set for Virtual Memory

If your Macintosh is using System 7 and is in Virtual Mode, it may exhibit slow performance during real-time graphics and animation. This is because your hard disk drive and CD-ROM drive must use your computer's SCSI bus almost simultaneously. To remedy this, remove Virtual Mode from the system and restart the Macintosh.

Contacting Plextor's Technical Support Department



YOUR TASK: Learn the variety of methods you can use to contact Plextor's Technical Support Department. Learn what information you should gather before contacting Plextor's Technical Support Department.

YOUR OBJECTIVE: Know how to get in contact with Plextor if you experience any problems installing or operating your 4PleX CD-ROM drive.

YOUR METHOD: Store Plextor's phone, fax and BBS numbers in a convenient location. Keep your drive's serial number and a copy of your sales receipt handy, as well.

If you experience a problem while installing or operating your 4PleX drive, please refer first to the troubleshooting chapter (Chapter 13) in this manual. It contains solutions to the most common types of problems fielded by our technical support staff. 

Our technical support department will help you solve problems that relate specifically to your 4PleX drive. In many cases, a problem that appears to be caused by your CD-ROM drive actually originates in another part of your computer. In such instances our technical support staff will try to help you identify the part (e.g., SCSI interface board) at fault, and will refer you to the manufacturer of that part for further assistance.

Although we think highly of the capabilities of our technical support staff, we recognize that they do suffer from some limitations; namely, they do not possess psychic or telepathic powers. Therefore, their ability to help you depends a great deal on your ability to help them. You must act as their eyes and ears as they try to diagnose and fix your problem. If you gather the information requested on the following page before your call, you will find that your problem can be resolved much more quickly.

Plextor's Technical Support Department is available Monday through Friday from 8:30 a.m. to 5:30 p.m. PST. We are closed on weekends and national holidays.

Plextor's Technical Support Department

There are three ways for you to contact Plextor's Technical Support Department:

- 1) Call 800-886-3935 and select the technical support extension.
- 2) Send a fax to the attention of the Technical Support Department at 408-986-1010. Include your telephone number and the hours during which you can be reached. Be as detailed as possible in describing your problem. It typically is useful if you also send a printout of your `autoexec.bat` and `config.sys` files.
- 3) Log on to our BBS (2400/9600/14.4/28.8/MNP, V.42bis) at 408-986-1569. You will find a great deal of useful information and software on our BBS. It includes:
 - Device drivers for various SCSI interface boards and soundboards (available only to those who have purchased these boards directly from Plextor).
 - Utilities to enhance the operation of your drive.
 - Discussions of various technical problems you might encounter, with suggestions as to how you might fix or circumvent them.

In addition, you can upload questions you have about the installation or operation of your 4PleX drive. A member of Plextor's Technical Support staff will respond to your question either by phone or modem.



Before You Call/FAX/Log On

Please gather as much of this information as possible:

- ✓ The serial number of your CD-ROM drive (your serial number can be found both on the warranty card that accompanied the drive and on a label on the drive itself).
- ✓ The name and model number of your SCSI interface board (e.g., Future Domain TMC-1610, Adaptec AHA-1515, Trantor T-130).
- ✓ The version of the software device drivers that came with your SCSI interface board (this typically is found on the label of the floppy disk which contains the device drivers).
- ✓ The version of the Windows|DOS|Mac|Novell|OS/2|Unix operating system you are using.
- ✓ The brand name and model number of your computer (e.g., Dell 466/NP, Micron P66PCI Powerstation, ALR Evolution V, Apple Performa 575).

- ✓ The type of VGA, Super VGA or other graphics card you use.
- ✓ Brand name and model number of any other peripherals you have installed/connected to your computer (e.g., scanner, fax board, network board).

Returns



You must receive an RMA (Returned Materials Authorization) number from the Technical Support Department before any Plextor CD-ROM drive can be returned for repair or replacement. Any drive sent to Plextor without an RMA number will not be accepted. Drives must be sent postage prepaid. We recommend that you insure your shipment, as Plextor cannot be held responsible for any damage that may occur during shipment.

Helpful Contact Phone/FAX/BBS NUMBERS

COMPANY <i>Product</i>	800 PHONE	PHONE	FAX	/ BBS
Adaptec <i>SCSI interface boards</i>	959-SCSI	408-945-8600	408-262-2533	408-945-7727
AMC <i>Audio Cables</i>	882-0587	206-882-0587	206-861-8391	—
Always <i>SCSI interface boards</i>	—	818-597-9595	818-598-0110	818-597-0275
Diamond <i>Soundboards</i>	—	408-736-2000	408-730-5750	408-524-9301
DPT <i>SCSI interface boards</i>	322-4378	407-830-5522	407-260-5366	407-830-1070
DTC <i>SCSI interface boards</i>	—	408-942-0052	408-942-4010	—
Future Domain <i>SCSI interface boards</i>	—	714-253-0400	714-253-0913	714-253-0432
FWB <i>Mac device drivers</i>	—	415-474-8055	—	—
Pacific Inter Connects <i>Audio Cables.</i>	934-2839	408-249-7099	408-249-7097	
Plextor <i>Audio Cables. Recommendations of SCSI Soundboards.</i>	886-3935	408-980-1838	408-986-1010	408-986-1569
Trantor <i>SCSI interface boards and Mac device drivers</i>	(see Adaptec listing)			

Specifications

	PX-43CH Internal	PX-45CH External
Disc		
Useable Formats	CD-ROM Mode 1; CD-DA; CD-I; Video CD (MPEG); CD-ROM XA Mode-2, Form 1, Form 2; Photo CD	CD-ROM Mode 1; CD-DA; CD-I; Video CD (MPEG); CD-ROM XA Mode-2, Form 1, Form 2; Photo CD
Disc Diameter	12 cm. (60 min. & 74 min.)	12 cm. (60 min. & 74 min.)
Rotational Speed	Inner Track: 2120 rpm Outer Track: 800 rpm	Inner Track: 2120 rpm Outer Track: 800 rpm
Performance		
Data Transfer Rate	600 KB/sec.;	600 KB/sec.;
Non-sync	Burst: 2.5 MB/sec.	Burst: 2.5 MB/sec.
Sync	Burst: 4 MB/sec.	Burst: 4 MB/sec.
Access Speeds:		
1/3 stroke	235 ms	235 ms
Random Access	220 ms	220 ms
Random Seek	150 ms	150 ms
Data Buffer	1 MB	1 MB
Optical Pickup	Semiconductor	Semiconductor
Laser	Linear Motor	Linear Motor
Side Mechanism	Brushless	Brushless
Spindle Motor		
Error Rate	Mode 1: 1 Block/10 ⁻¹² Bits; Mode 2: 1 Block/10 ⁻⁹ Bits	Mode 1: 1 Block/10 ⁻¹² Bits; Mode 2: 1 Block/10 ⁻⁹ Bits
Front Panel		
Indicator (LED)	Power ON/BUSY DISC IN	Power ON/BUSY DISC IN
Disc Loading	Manual; standard caddy	Manual; standard caddy
Headphone Jack	Stereo minijack, 0.9V at 32 Ohms	Stereo minijack, 0.9V at 32 Ohms
Volume Control	Wheel Knob	Wheel Knob

	PX-43CH Internal	PX-45CH External
Rear Panel		
Power Supply	DC +5V, 0.41A; DC +12V, 0.6A	AC 100-240V 50/60 Hz., 0.3A (Auto Switching)
Power Switch	—	Tumbler Type: 3A, 250V
Interface Connector	SCSI Bus, 50-Pin Header Type	SCSI Bus, Two 50-Pin Centronics
Audio Output	Analog Output, Molex Connector (P/N 70066-G 4-pin) Use Molex Housing (P/N 70553 4-pin)	Analog Output, RCA Jacks
Jumper Switches	SCSI ID, Auto, Parity, Test, Block, Eject	—
DIP Switch	—	Auto, Parity, Test Block, Eject
Rotary Switch	—	SCSI ID
Environmental Conditions		
Operating		
Temperature:	5 to 40 degrees Celsius	5 to 40 degrees Celsius
Humidity	20 to 80% Noncondensing	20 to 80% Noncondensing
Storage		
Temperature	-30 to 55 degrees Celsius	-30 to 55 degrees Celsius
Humidity	10 to 80% Noncondensing	10 to 80% Noncondensing
Dimensions and Weight		
Dimensions (W/H/D)	5.75" x 1.63" x 7.95"	7.0" x 2.24" x 12.03"
Weight	2.9 lbs.	6.2 lbs.
Reliability		
MTBF	150,000 POH	150,000 POH
Caddy Loading	15,000 Times	15,000 Times

ABOUT PLEXTOR

Plextor is a subsidiary of the Shinano Kenshi Company (SKC), Ltd.

SKC's roots stretch back to 1918, when it began to manufacture textiles in Japan's northern prefecture of Nagano. (Nagano, incidentally, will be the site of the 1998 Winter Olympics.) SKC's involvement in the electronics industry started in 1962, when it diversified into the production of stepper motors for commercial audio products. SKC is now one of the world's largest manufacturers of small motors used in hard disks, floppy disks, tape drives, copy machines, video cameras — and your Plextor CD-ROM drive.

Over the past decade SKC has developed a reputation as an innovator in compact disc and CD-ROM technology. In 1992 it was the second company to begin shipments of double-speed CD-ROM drives. In 1994, it was the first company to begin shipments of half-height quad speed CD-ROM drives. SKC also is a leading manufacturer of compact disc players used for industrial and commercial applications (e.g., background music players for retail stores, restaurants and shopping centers).

Plextor acts as SKC's sales, service and support arm throughout the world. In addition to CD-ROM drives, Plextor also sells under its own label professional audio equipment used by radio stations, high-speed printing presses, and a CD encoding system developed by SKC that can pack up to eight hours of audio onto a single compact disc.

Plextor's home office is located in Tokyo. Plextor first opened an office in California's Silicon Valley in 1990. Rapid growth has required it to move twice since then to larger offices. Plextor now occupies a 30,000 sq. ft. facility in Santa Clara, CA, which is staffed by sales, marketing, technical support, engineering, administrative and shipping personnel. Its European office (located in Brussels) began operation in 1994.

The PX-43CH and PX-45CH represent the fifth generation of CD-ROM drives that SKC has brought to the market through Plextor. In addition to stand alone CD-ROM drives, Plextor also sells drives in kit, bundle and tower (4-bay and 7-bay) configurations.

Plextor's CD-ROM Drives					
	Model	Introduced	Data Transfer Rate	Access Speed	Buffer Size
1st generation	DM-3020/5020	1990	150KB/sec	430ms	64K
2nd generation	DM-3021/5021	1991	150KB/sec	340ms	64K
3rd generation	DM-3024/5024	1992	300KB/sec	265ms	64K
4th generation	DM-3028/5028	1993	335KB/sec	240ms	64K
5th generation	PX-43CH/45CH	1994	600KB/sec	220ms	1MB

Warranty Information

PLEXTOR CORP. (PLEXTOR), warrants your 4PleX CD-ROM drive against any defect in material and workmanship, under normal use, for a period of two years following its date of purchase. In the event this product is found to be defective within the warranty period, PLEXTOR will, at its option, repair or replace the defective CD-ROM drive.

This warranty is void if: a) the drive is operated or stored under abnormal use and maintenance conditions; b) if the drive is repaired, modified or altered, unless such repair, modification or alteration is expressly authorized in writing by PLEXTOR; c) if the drive is subject to abuse, neglect, lightning strike, electrical fault, improper packaging, or accident; d) if the drive is installed improperly; or, e) if the serial number of the drive is defaced or missing.

PLEXTOR will not, under any circumstances, be liable for direct, special or consequential damages such as, but not limited to, damage or loss of property or equipment, loss of profits or revenues, cost of replacement goods, or expense or inconvenience caused by service interruptions. Under no circumstances will any person be entitled to any sum greater than the purchase price paid for the drive.

To obtain warranty service, you may contact PLEXTOR's Technical Support Department by calling 800-886-3935. They will attempt to diagnosis and correct your problem by phone. If the drive does not function properly they will issue a Return Material Authorization (RMA) number. You may be asked to furnish proof of purchase to confirm that the drive is still under warranty.

All 4PleX CD-ROM drives returned to PLEXTOR must be securely packaged and shipped postage prepaid. All product returns must be authorized in advance by PLEXTOR's Technical Support Department. Authorization is confirmed by issuance of the RMA number, which must be written prominently on the outside of the box in which a defective drive is returned to PLEXTOR.



PLEXTOR (U.S.)

4255 Burton Drive, Santa Clara, CA 95054

Phone: 408-980-1838

FAX: 408-986-1010 BBS: 408-986-1569

Toll Free: 800-886-3935

PLEXTOR (Japan)

Ueno YHK Building, 7th Floor

7-6 Ueno 7-chome, Taito-ku, Tokyo 110

Phone: 81-3-3847-8281 FAX: 81-3-3847-8288

PLEXTOR (Europe)

Excelsiorlaan 1, 1930 Zaventem, Belgium

Phone: 32-2-725-5522 FAX: 32-2-725-9495