VISICALC[®]

INSTANTLY CALCULATING 'ELECTRONIC WORKSHEET'



VISICORP[™]
PERSONAL SOFTWARE[™]

Manual Copyright © 1981 VisiCorp
All Rights Reserved.

Program Copyright © 1979, 1981 Software Arts, Inc.
All Rights Reserved.

Printed in U.S.A.

Apple®, Disk II™, Apple Language System™, and Silentype™ are trademarks of Apple Computer Inc.

Centronics® is a trademark of Centronics Data Computer Corp.

Diablo® is a trademark of Xerox Corp.

DIF™ is a trademark of Software Arts, Inc.

Spinwriter™ is a trademark of NEC Information System, Inc.

Qume® is a trademark of Qume Corporation.

VisiCalc® is a registered trademark of VisiCorp

Part Number: 10911-2212

VISICALC[®]

INSTANTLY CALCULATING 'ELECTRONIC WORKSHEET'

**User's Guide
for the APPLE II & II PLUS
48K 16 Sector**

Program by
Software Arts, Inc.

Manual by
Dan Fylstra and Bill Kling



VISICORP™
PERSONAL SOFTWARE™

Table of Contents

PART I. INTRODUCTION

How to Use This Manual	1-1
Overview: The "Electronic Sheet"	1-1
What You Need	1-3
Some Notes on Your Keyboard	1-4
A Word on Diskettes	1-4
Loading the VisiCalc Program	1-5
Initializing VisiCalc Storage Diskettes	1-7

PART II. VISICALC TUTORIAL

Lesson One

Moving the Cursor	2-2
Scrolling the Window	2-3
The Repeat Key	2-3
Direct Cursor Movement	2-4
Editing with the ESC Key	2-5
Writing on the Electronic Sheet	2-6
Formulas and Recalculation	2-7
More on Labels and Values	2-8
Cursor Moves in Formulas	2-10
More on Editing	2-12
Saving the Electronic Worksheet on Diskette	2-12
The RESET Key	2-14
Postscript: Protecting Your Work	2-15

Lesson Two

Loading the Sheet from Diskette	2-18
Replicating a Formula	2-20
Replicating a Range of Formulas	2-23
Formatting the Screen Display	2-24
Fixing Titles In Place	2-25
Now for a Quick Recalculation	2-26
Adjusting Column Widths	2-27
Splitting the Screen	2-29
Global Commands in Separate Windows	2-32
Summary	2-33
Postscript: Memory and the Electronic Sheet	2-34
Shrinking the Sheet	2-35

Lesson Three

Setting Up for the Budget Sheet	2-36
Replicating Numbers and Labels	2-37

Using Formulas for Flexibility	2-38
Replicating Down a Column	2-40
Replicating a Column Several Times	2-41
Fixing Titles in Both Directions	2-43
The Built-In Function @Sum	2-44
Formatting a Single Entry	2-46
Replicating a Format Specification	2-48
Using Replicate To Copy a Row or Column	2-48
Changing Windows and Titles	2-49
The @NA and @Error Functions	2-52
The Insert and Delete Commands	2-53
Calculating Interest on a Savings Account	2-55
The Move Command	2-57
Obtaining Monthly Expense Percentages	2-58
Synchronized Scrolling	2-60
The Order of Recalculation	2-61
Forward and Circular References	2-63
Summary	2-64
Postscript: The Print Command	2-65
Lesson Four	
More on Numbers and Formats	2-66
Scientific Notation	2-67
More on Value References	2-68
More on Formulas	2-69
More on Built-in Functions	2-70
Transcendental Functions and Graphing	2-74
Manual and Automatic Recalculation	2-78
Summary	2-80
PART III. VISICALC COMMAND REFERENCE	
Introduction to Part III, the Command Reference	3-1
Command Structure Chart	3-3/3-4
BLANK Command	3-5
CLEAR Command	3-6
DELETE Command	3-7
EDIT Command	3-11
File Names	3-14
Device Suffixes	3-14
Scrolling	3-15
FORMAT Command	3-16
The Default Format Command: /FD	3-17
The General Format Command: /FG	3-17
The Integer Format Command: /FI	3-18
The Left Justification Format Command: /FL	3-18
The Right Justification Format Command: /FR	3-19

The Dollars and Cents Format Command: /F\$	3-20
The Bar Graph Format Command: /F*	3-20
GLOBAL Command	3-21
The Global Column Command: /GC	3-21
The Global Order of Recalculation Command: /GO	3-22
The Global Recalculation Command: /GR	3-26
The Global Format Command: /GF	3-26
GO TO Command	3-27
INSERT Command	3-28
The Insert Row Command: /IR	3-28
The Insert Column Command: /IC	3-30
LABEL ENTRY Command	3-32
MOVE Command	3-34
Moving a Row	3-34
Moving a Column	3-36
PRINT Command	3-40
Setting Up and Testing	3-40
Printing to a Printer	3-42
The Setup String	3-44
Carriage Return and Line Feed	3-46
Printing Out in Sections	3-46
Creating a Print Format File	3-47
Printing Out Formulas and Formats	3-48
REPEATING LABEL Command	3-49
REPLICATE Command	3-51
Copying from One Entry Position to Another	3-52
Creating a Column of Entries from One Entry	3-53
Copying a Column from One Position to Another	3-53
Making Several Copies of a Column	3-54
Copying a Row from One Position to Another	3-55
Replicating Value References	3-56
STORAGE Command	3-60
Loading a File from Diskette: The /SL Command	3-60
Saving Files on Diskette: The /SS Command	3-62
Deleting Files from a Diskette: The /SD Command	3-64
Initializing Storage Diskettes: The /SI Command	3-64
Quitting the VisiCalc Program: The /SQ Command	3-65
The DIF	3-65
Saving Files in the DIF Format: The /S#S Command	3-66
Loading a DIF File: The /S#L Command	3-67
TITLES Command	3-68
VALUE ENTRY Command	3-70
VisiCalc Formulas	3-70
Value References	3-71

VisiCalc Values	3-72
Order of Precedence in the VisiCalc Program	3-72
Using the VisiCalc Program as a Calculator	3-72
Copying a Value without Replication	3-73
Recalculation Order	3-74
Forward and Circular References	3-75
The VisiCalc Program's Built-In Functions	3-75
Function with Arguments	3-76
@CHOOSE (list)	3-77
@LOOKUP (v,range)	3-77
Function without Arguments	3-79
Logical Functions	3-79
Making the VisiCalc Program Less Precise	3-81
VERSION Command	3-83
VisiCalc Screen	3-84
The Window and Worksheet	3-85
Entry Positions	3-86
The Cursor	3-86
Moving the Cursor	3-86
The Repeat Key (REPT)	3-86
Pointing with the Cursor	3-87
Typeahead	3-87
Correcting Mistakes	3-87
The Memory Indicator	3-87
WINDOW Command	3-88
The Horizontal Window Command: /WH	3-88
The Vertical Window Command: /WV	3-90
The One Window Command: /W1	3-91
The Synchronized Window Scrolling Command: /WS	3-91
The Unsynchronized Window Scrolling Command: /WU	3-91
Appendix A:	
Using DOS 3.3 with VisiCalc Files	A-1
DOS 3.3 Commands	A-1
INIT	A-1
MASTER CREATE	A-1
COPY	A-2
FID	A-2
MUFFIN	A-2

Appendix B:

Exchanging Files	B-1
The Save DIF™ Option: /S#S	B-2
Load DIF™ Option: /S#L	B-2
The DIF™ Format	B-4
Header	B-5
Data Records	B-5
End-of-Data Records	B-6
Programs That Work With the DIF™ Format	B-6
Dumping a DIF™ File	B-6
Printing a Worksheet from a DIF™ File	B-8
Creating a DIF™ File	B-10

INDEX

Index	I-1
-------------	-----

How to Use This Manual

This manual has been prepared to help you learn to use the VisiCalc™ program easily and quickly. Its three sections take into account the fact that different people will have differing levels of computer experience.

Part I contains an overview of the VisiCalc program, information about your equipment needs, and complete instructions for loading the VisiCalc program and preparing diskettes for use with the VisiCalc program.

Part II is a step-by-step Tutorial comprising four lessons on how to use the VisiCalc program with your Apple® II or Apple II Plus. Those with little or no experience with personal computers will find that it anticipates many of the questions and problems that may arise.

Each lesson will show you exactly what to type, keystroke by keystroke. You should study it by working through the examples at your computer. As you practice, you'll gain familiarity and confidence in using some of the more advanced features of the VisiCalc program. Before long, you'll need only Part III and the VisiCalc® Pocket Reference.

Part III is the VisiCalc Command Reference. It contains a chart of VisiCalc commands illustrating their relationships, notes on the elements of the VisiCalc screen display and keyboard, and a detailed discussion of each command with examples of its use.

You will probably find yourself referring to this section frequently, especially as you use the advanced features of the VisiCalc program to speed your work and do complicated applications. The commands presented in this part of the manual are summarized in the VisiCalc Pocket Reference.

The best way to learn how to use the VisiCalc program is to try it. Experiment! Trying out ideas will help you answer a lot of your questions, while enhancing your experience and confidence. Entering "odd" data and patterns will not hurt the computer or the VisiCalc program. Physical care, however, must be paid both to the computer and the diskettes. Always handle diskettes gently, keeping them away from magnetic fields, dirt, and liquids.

Overview: The "Electronic Worksheet"

The VisiCalc program was born out of the observation that many problems are commonly solved with a calculator, a pencil, and a sheet of paper — three nearly universal tools. Calculating sales projections, income taxes, financial ratios, your personal budget, engineering changes, cost estimates, and balancing your checkbook are done with these tools.

The VisiCalc program combines the convenience and familiarity of a pocket calculator with the powerful memory and electronic screen capabilities of the personal computer. With the VisiCalc program, the computer's screen becomes a "window" that looks upon a much larger "electronic worksheet." You can move or "scroll" this window in four directions to look at any part of the worksheet, or you can split the computer screen into two "windows" to see any two parts of the worksheet at the same time.

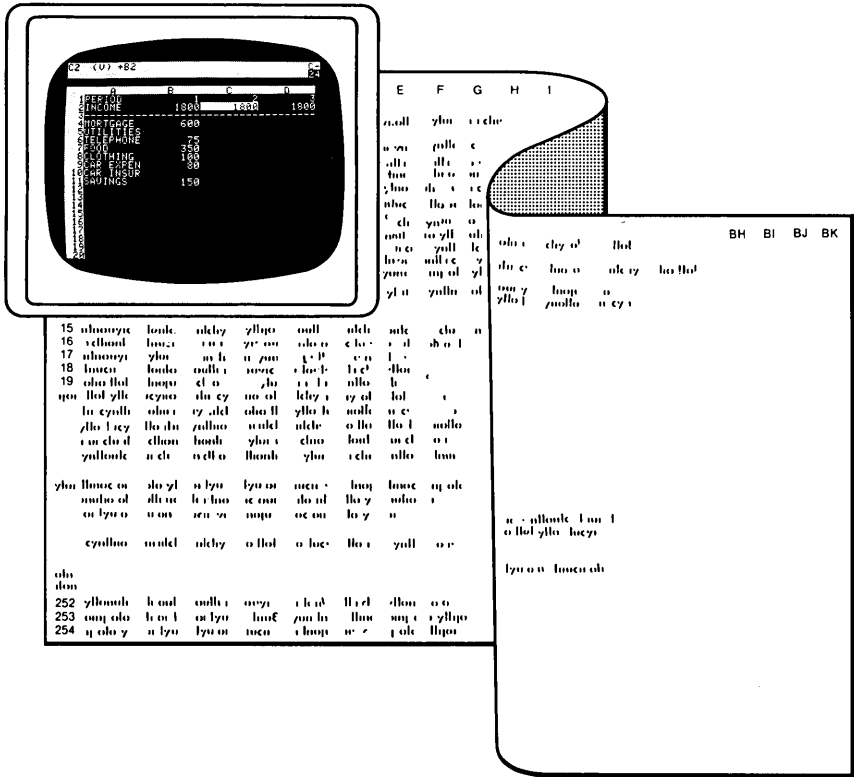

Figure 1-1. YOUR SCREEN IS A WINDOW INTO THE ELECTRONIC SHEET IN THE COMPUTER'S MEMORY

The worksheet is organized as a grid of columns and rows. The intersecting lines of the columns and rows define thousands of entry positions. At each position you can enter an alphabetic title, a number, or a formula to be calculated. Just by "writing" on the worksheet, you can set up your own charts, tables, and records.

The formatting commands let you individualize the appearance of each entry, row, or column. If you wish, for example, you can make your VisiCalc checkbook record look just like your bank statement.

But the power of the VisiCalc program lies in the fact that the computer **remembers** the formulas and calculations you use in solving a problem. If you change a number you had previously written on the electronic worksheet, all other related numbers on the worksheet change before your eyes as the VisiCalc program automatically recalculates all of the relevant formulas.

Recalculation makes the VisiCalc program a powerful planning and forecasting tool. You can correct mistakes and omissions, and examine various alternatives — effortlessly.

INTRODUCTION

For example, imagine that you are doing sales projections using the VisiCalc program. You may want to know what the impact on your company will be if a specific project doesn't sell as well as you anticipate.

What if you sell only 200 "widgets" a month instead of 250? What if you sell 300? What if one of your salesmen quits, and it takes six weeks to bring a new person up to speed? With the VisiCalc program, playing "what if" is usually a matter of changing a single number. Doing the same thing with a calculator, pencil, and paper might take hours of erasing and recalculating.

The VisiCalc program lets you change, insert, or delete titles, numbers, or formulas. The existing VisiCalc chart or table is instantly restructured with all of the columns, rows, and other formulas edited to reflect your changes.

If you've entered a formula at one position, the VisiCalc program lets you replicate it at other positions. The VisiCalc program will also sum, average, or otherwise manipulate rows, columns, or other ranges of numbers.

Once you've established the format for a particular application, you just enter or change numbers. You can save the electronic worksheet on a diskette and print all or part of the worksheet on a printer.

You can learn the elementary features of VisiCalc in an hour or two and be able to solve simple problems. As you use the VisiCalc program for more complicated applications, you'll discover that it has a broad range of features and commands. You can learn these features and commands as you need them.

What You Need

To use the VisiCalc program, you will need the following components:

- 1) Your Apple II or Apple II Plus with at least 48K of memory. The VisiCalc program will support up to 64K of memory.
- 2) The Apple Disk II™ Disk Drive .
- 3) Some blank 5¼ " diskettes.
- 4) The VisiCalc program diskette, enclosed in the inside front cover of your manual.
- 5) A TV set or other video monitor. A black and white set is fine.
- 6) Optionally, the Apple Language System™ to increase memory by 16 kilobytes. We also recommend a printer with appropriate interface card for hard copy reports.

Some Notes On Your Keyboard

This manual illustrates the use of the VisiCalc program on the Apple II computer with numerous examples. It tells you how to enter each command keystroke by keystroke. We do assume, however, that you will press the **SHIFT** key if necessary. Use **SHIFT** just like you would on a typewriter, i.e., by holding it down while you type the key with the character you want.

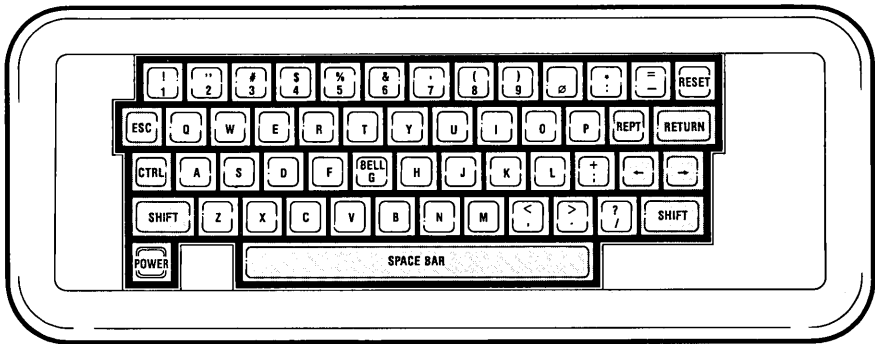



Figure 1-2. THE APPLE II KEYBOARD

With the Apple keyboard illustrated above, you will need to press **SHIFT** to type special characters such as the asterisk, the “greater than” sign, quotation marks, exclamation point, the exponentiation symbol, and the “at” sign.

A key that you operate much like **SHIFT** is the key marked **CTRL** (for **CONTROL**). When you are told to type “CTRL C”, for example, you must hold down the **CTRL** key *while* you press **C**. Release the **CTRL** key after you’ve released the “C” key.

Also note the positions of the keys that are shaded in the keyboard drawing. You will use them a great deal.

Throughout this manual, we will substitute the symbol ® for the key labeled **RETURN**

Likewise, we will indicate the space bar with the (S) symbol. (S) is used in conjunction with the two arrow keys   to tell VisiCalc whether to move the cursor horizontally or vertically. We’ll tell you more about this in the “Moving the Cursor” section of Part II, Lesson One.

A Word on Diskettes

A word of caution about the handling of diskettes — you can’t be too careful with diskettes! Each diskette is a small, magnetically coated plastic disk, sealed in a protective square plastic cover. Through the oval cutout in the square cover, you can see the magnetic surface of the actual diskette.

INTRODUCTION

Never touch the exposed magnetic surface with your fingers or any implement. Protect the diskette from dust by storing it in the paper sleeve it comes in. Keep it at least six inches from magnetic fields such as those generated by a TV. Extremes of temperature (such as in a car trunk on a warm day) could destroy a diskette, and you would lose your data, or your VisiCalc program. Don't bend, staple, or write on the square plastic cover with a hard pen or pencil (use only the soft felt tip pens).

Loading the VisiCalc Program

First, make sure that your video monitor or TV set is connected, your disk drive hooked up, and that the Apple is plugged in. Note: never touch the inside of your Apple, its interface cards, or external connections while the power is on.

Assuming that your Apple is off (the POWER light at the left corner of the keyboard will be unlit) follow these instructions.

- 1) Turn your video monitor or TV set ON.
- 2) Open the door of drive 1 by lifting up on it and gently insert your VisiCalc program diskette label side up with the label entering last (see the illustration below). Close the drive door by pushing down on it until you hear it click shut.
- 3) Turn the power switch at the left rear corner of your Apple ON.

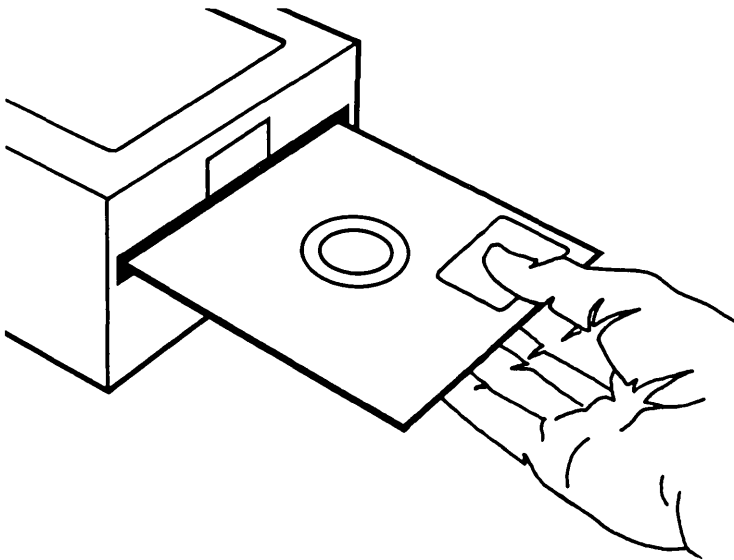
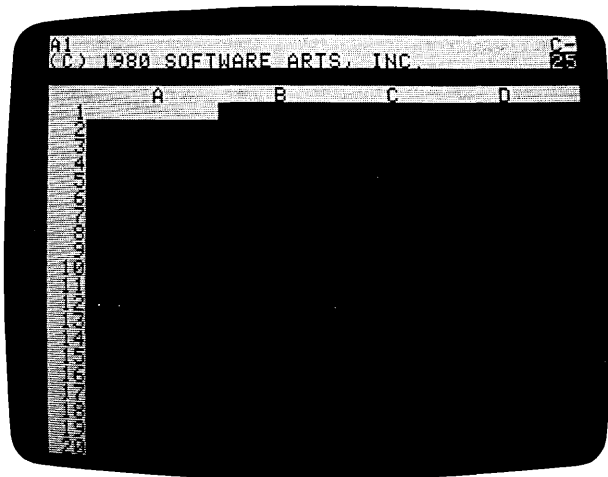

Figure 1-3. INSERTING A DISKETTE

If you have Autostart ROM, the Language System, or the Applesoft Firmware card, the Apple will beep, the Disk II will whirl and click, the IN USE light will come on, and you'll see the letters VC in the upper left corner of the screen. Shortly thereafter, a screen display resembling the one in the photo below will appear. You will have successfully loaded the VisiCalc program.



However, if you have a basic Apple II without any of these Autostart components, you will see screen full of random characters with an asterisk and a blinking box in the left bottom corner. The Disk II will remain inactive. To activate the drive and load the VisiCalc program, you must perform the following steps.

- 1) Press the key marked **RESET**
- 2) Assuming that your Disk II controller card is in slot 6, type **6** If it is in a different slot, type the number of that slot instead.
- 3) Hold down the key marked **CTRL** while pressing **P**
- 4) Press the key marked **RETURN**

This combination of characters is referred to as **RESET 6 CONTROL P RETURN** and must be executed every time you want to "boot up" or activate Disk II from an Apple without Autostart ROM. See your DOS manual for more details.

If nothing happens:

- 1) Read the instructions again.
- 2) Turn off the Apple and check to see which slot number the Disk II controller card is in. Also make sure that the ribbon cable is connected to the pins on the controller card.
- 3) If, after a few more attempts, the drive still doesn't activate, see your dealer.

If the drive starts whirring but doesn't stop, wait for about 15 seconds (it won't hurt the drive). Then press the key marked **RESET** In a few seconds the drive will stop and the IN USE light will go out.

INTRODUCTION

Open the drive door and gently remove the program diskette. Make sure that you inserted it properly — label side up, label in last. Reinsert the diskette and close the drive door.

Turn the Apple off and then on again. If your efforts prove unsuccessful after a few tries, see your dealer.

Assuming that the VisiCalc program loaded successfully, look at your screen for a moment. The second line contains the copyright notice and the version number. The third line contains a serial number unique to your particular diskette. As with any valuable item, write this number down and store it in a safe place.

Remove your VisiCalc program diskette from the Disk II drive and replace it in its sleeve (label showing). Return it to the inside front cover pocket of your VisiCalc binder; you won't need it again until the next time you turn on your computer.

Never leave your VisiCalc program diskette in the drive. It could be harmed by power failures or mechanical failures in the drive. Be careful too with your data storage diskettes. Although they are replaceable, misuse can lose hours of work. Always remove a diskette before turning off the drive. And **NEVER** open the drive door, try to remove a diskette, or turn the power off when the IN USE light is on.

Initializing VisiCalc Storage Diskettes

You must make a working diskette for storing the information you will be creating with the VisiCalc program. Take out a blank diskette or a previously used diskette that you don't mind erasing. Notice that a blank diskette has a small notch cut out of its side.

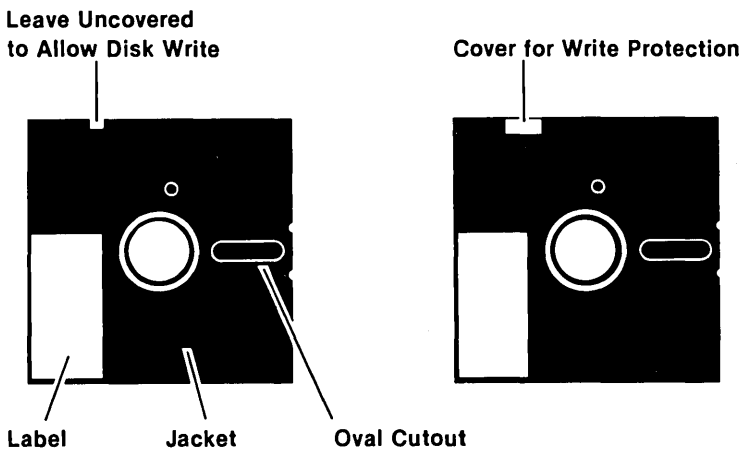

Figure 1-4. A DISKETTE AND A WRITE-PROTECTION DISKETTE

Your Disk II drive senses this notch to see if it can write information on the diskette's surface. For its protection, the VisiCalc program diskette does not have this notch. Hence, it is said to be "write-protected."

Take out one of the adhesive diskette labels and write some identifier on it like, "VisiCalc Storage Diskette #1." Add the date and apply this label to the diskette jacket near the manufacturer's label. If the title label is already on the diskette, be sure to write with a felt tip pen, not a ballpoint. Label all diskettes you plan to initialize.

Carefully insert the blank diskette into drive 1 just as you did with the VisiCalc program diskette. The label must be up and enter last. Close the disk drive door.

Follow the instructions below and watch the lower half of the white bar at the top of the screen. The lower half is actually a second line. This line is called the VisiCalc **prompt line**, and is described more fully in Lesson One of Part II and in Part III.

- 1) Press the / (slash) key. Your serial number and the title will disappear from the screen. The prompt line will read
COMMAND: BCDEFGIMPRSTVW-
- 2) Press the letter **S** key. The prompt line should read
STORAGE: L S D I Q #
- 3) Press the letter **I** key. The prompt line should read
INIT DISK: TYPE RETURN TO ERASE DISK
Just below it (on the edit line) you'll see
, S6, D1
(for Slot 6, Drive 1) followed by a flashing box called the **edit cue**. If you have your controller card in a slot other than six or if you have the storage diskette in drive 2, you must change these device numbers. To do this, jump ahead to Part II, Lesson One, and the section "Editing with the ESC Key". Device numbers are also discussed in Lesson One in "Saving the Electronic Worksheet on Diskette" and in Part III, FILE NAMES. For information on the various Storage command options, see Part III, the STORAGE Command.
- 4) Just press **Ⓜ** (the RETURN key). The red IN USE light on the drive should come on, accompanied by whirring and scraping noises. It takes about one and a half minutes to complete the initialization process. Toward the end of that time, the prompt and edit lines will clear.

In the initialization process, the computer is recording a pattern on the surface of the diskette, so that the VisiCalc program can find a given spot on the diskette and "write" information there or "read" it back later. Further, information "written" by one program (such as the VisiCalc program) can be located later and "read" by a different program (which could be written in BASIC).

Note: if you initialize a diskette that has had data stored on it from some previous use, either by the VisiCalc program or some other program, that data will be erased by this process.

INTRODUCTION

After the disk drive quiets down and the red BUSY light goes off, open the drive door and carefully remove the newly initialized diskette and place it back in its paper sleeve. **Never** open the door or insert or remove a diskette while the drive is whirring or the IN USE light is on; this will probably damage the diskette.

At this point, you may wish to initialize additional diskettes for use with the VisiCalc program. Simply insert a new blank diskette, close the drive door, and follow the four-step initialization procedure above. One further note: you can also use diskettes initialized with the BASIC INIT program to store VisiCalc electronic sheets.

When you've finished, you'll be ready to go on to Lesson One of the Tutorial and begin learning to use the VisiCalc program. Your screen should resemble the photo below.

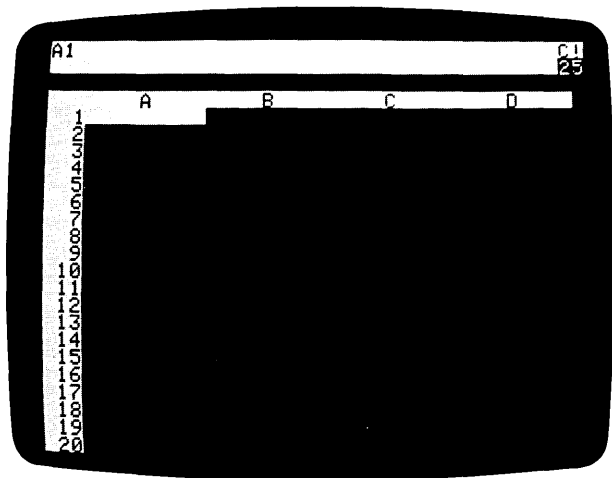

Lesson One

To study the Tutorial, you must have the VisiCalc program loaded into your computer. If you don't, follow the instructions in the Introduction section titled "Loading VisiCalc." If the VisiCalc program is loaded, type *ICY* to clear the screen. Your screen should look like the photo below.

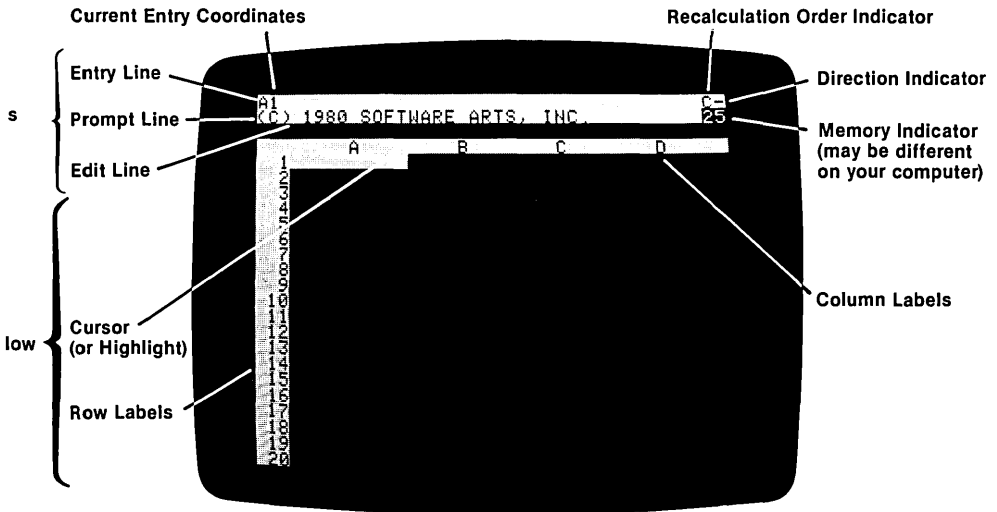

Figure 2-1. THE VISICALC SCREEN

Your screen has become a **window** into the computer's memory. The VisiCalc program has organized the screen as an **electronic worksheet** by dividing it into rows and columns. Rows are vertically numbered (1, 2, 3, etc.) while columns are horizontally lettered (A, B, C, etc.). Each intersection of a row and a column **coordinate** (A1, B3, C17) marks an **entry position**.

At each entry position, you can type in a message, a number, or formula. In a moment we'll demonstrate how you can write at different entry positions on this electronic worksheet.

Look at the white bar and dark line at the top of the screen (just above the column labels). This is called the **status area**. The bar is actually two lines. The top line is called the **entry line** and the second line is the **prompt line**. The prompt line currently displays the VisiCalc copyright notice and **version number**. Your program diskette serial number is on the edit line.

Should you ever need to call or write VisiCorp to ask questions or to report problems with the VisiCalc program, please tell us your version number and the model of your computer.

The dark line below the prompt line is called the **edit line**. It contains another important number: the serial number unique to your particular VisiCalc diskette.

The right corner of the status area includes

- 1) the **Recalculation Order Indicator** (to be discussed in Part II, Lesson Four)
- 2) the **Memory Indicator** that tells how much memory is available (the number may be different on your computer)
- 3) the **Direction Indicator**, which we will discuss momentarily.

Press the key marked **RETURN**. As we mentioned in the section, "Notes on Your Keyboard", in Part I, we'll indicate the **RETURN** key with the symbol ®. The copyright notice, version number, and serial number will disappear. Now type **IV** and all three will reappear. Just type **IV** anytime you want to see your version number. Press any key (including the space bar) to make this version information disappear. See the **VERSION** Command in Part III for details.



Moving the Cursor

Look at the point where column **A** and row **1** intersect. This is coordinate **A1**. To keep you from getting lost on the electronic worksheet, the VisiCalc program prints the coordinate for you on the entry line. See it? Notice that a white rectangle covers entry position **A1**, blending into the top and left frames of the screen. This rectangle is called the **cursor**.



The cursor's position marks the point where you can begin writing on the electronic worksheet. Think of it as the point where your pencil or pen meets the paper. If you want to write at an entry position other than where the cursor presently rests, you must move the cursor to the new position.

Look at the right corner of the entry line. Just to the right of the **C**. You'll see either a dash (-) or an exclamation point (!). This is the cursor **direction indicator**. Pressing the space bar will change it from one form to the other. When you first load the VisiCalc program, the direction indicator always appears as - indicating *horizontal* cursor motion. The ! indicates *vertical* cursor motion.

Now press the space bar which we will symbolize with (S). If you had -, it changed to !. Likewise if you had !, it changed to -. If the direction indicator is !, press (S) once more so that it is -.

Now look at the two arrow keys at the right of your keyboard. With the direction indicator set for horizontal motion (-), pushing the  key will move the cursor to the right. Pushing the  key will move it to the left. Press the  once.

The cursor should move to **B1** (column **B**, row **1**). Look at the entry line. Not only are the copyright and version numbers gone, but the cursor coordinate indicator (on the left end of the entry line) reads **B1**. Press  and the cursor moves back to **A1**.

Press (S) and look at the right corner again. You will see an exclamation point (!). The ! direction indicator means that pressing the  key will cause the cursor to move upward. Pressing the  key the cursor will move downward.

Press **↓** The cursor will move down to entry position A2 (column A, row 2).
Now press the **↑** The cursor returns to entry position A1.

If, while you are practicing, you make a typing error and see either the word VALUE or LABEL appear on the prompt line, don't worry. Just type **CTRL C**, by *holding down* the key marked **CTRL** while pressing **C**. The word will disappear along with the number or letter beneath it. The noise made by the **CTRL C** key is called a beep. We'll go into more detail on the words Value and Label and correction methods a little later in the manual.

Scrolling the Window

When you first load the VisiCalc program, your screen window is positioned to let you look at the upper left corner of the VisiCalc electronic worksheet. On the Apple II, the window allows you to see the first four columns (A through D) and the first twenty rows (1 through 20) of the worksheet.

Make sure the direction indicator is set to - (press (S) if it isn't). With the cursor at A1, press **→** three times until the cursor rests at the right edge of the window at D1. Press the right arrow key **→** again. Notice that the next column to the right, the E column, comes into view while column A disappears off the left edge of the window.

When this happens, we say that the window has **scrolled** to the right. Try pressing **→** a few more times, watching more columns appear at the right edge of the window while others disappear at the left.

The screen window will also scroll to the left. (In fact, it will scroll in all four directions.) Press the left arrow key **←** until the cursor is at the left edge of the window. Then press **←** several more times and notice that the columns that had disappeared as you scrolled the window to the right come back into view. Press **←** until the cursor is back at position A1.

Now try pressing **←** one more time. You should hear a soft noise called a thud. This is the VisiCalc program's way of telling you that you are bumping into an edge of the worksheet.

Press (S) so that the direction indicator reads ! and press **↑** This time you hear the thud because you are bumping the cursor into the top edge of the worksheet. So far we have encountered the left edge and the top edge of the worksheet. Now we will show you the other two edges.

Press **↓** repeatedly until the cursor has moved down to position A20. Then press **↓** once more. Notice that row 21 comes into view while row 1 disappears off the top of the screen window. Press the **↓** key a few more times. As you can see, the electronic worksheet is quite a bit larger than an ordinary sheet of paper.

The Repeat Key

We can scroll to the bottom edge of the worksheet more quickly by using the Apple's REPT (for Repeat) key. To see this in action, first press the **↓** key and *hold it down*. Now press the key marked **REPT** and hold it down at the same time.

The cursor and the window should scroll downwards automatically. Continue to hold down the **↓** and **REPT** keys until you bump into the bottom edge of the electronic worksheet. The cursor will have reached position A254.

Let's move the cursor to the right edge of the worksheet. This calls for horizontal direction. Press (S) once to change the direction indicator to -. Once again press and hold down **↓** and **REPT** at the same time.

The cursor and window will go scrolling off to the right. As the cursor and window scroll to the right, notice how succeeding columns are lettered. Notice that these coordinates also appear in the upper left corner of the screen. After A, B, C,..., X, Y, Z comes AA, AB, AC,..., AX, AY, AZ, and then BA, BB, BC, The cursor finally stops at position BK254 as it bumps into the right hand edge of the worksheet. You are now at the lower right hand corner of the VisiCalc electronic worksheet.

Direct Cursor Movement

Even with the aid of automatic repeat, it took a while to scroll the cursor and window all the way to the lower right corner of the VisiCalc worksheet. There's an easy way to jump to another position on the worksheet that takes only a few keystrokes.

Type the character > (don't forget **SHIFT**). Two things will happen:

- 1) The message GO TO: COORDINATE appears on the prompt line just under the BK254 coordinate.
- 2) The edit cue (the little white box) appears directly below this message on the edit line.

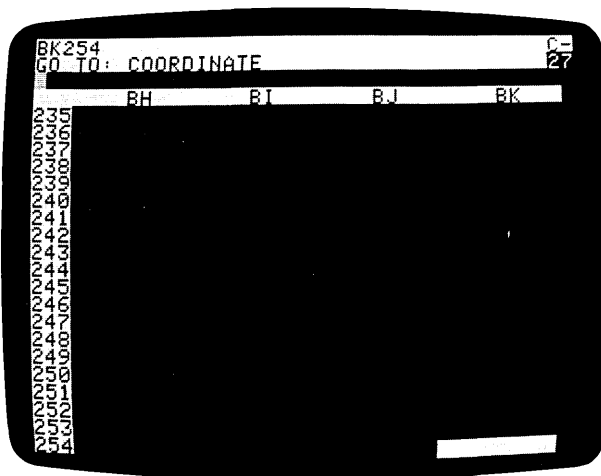

Each time you press a key, the VisiCalc prompt line tells you what you can type next. On screen above, the prompt line is telling you that the VisiCalc program has recognized your keystroke command **>**, and that it wants to know to what COORDINATE you want to GO TO. That means you must type in the letter and number of the position to which you want the cursor to move.

Press the **A** key once. The letter A will appear on the edit line (the dark line just above the column labels) followed by the edit cue. Type the number **1** key to move the cursor back to position A1.

So far, we have A1 on the edit line followed by the edit cue. The VisiCalc program is still waiting for you to type something. It doesn't know yet whether you want to go to position A1, or A11, or A121, or some other position.

Press the **Ⓡ** key. The information on the prompt and edit lines disappears, and the cursor and window move back to the upper left corner of the worksheet at A1.

Try another example. Type **> C10 Ⓡ** Note that the cursor now rests in mid-screen, directly below **C** and to the right of **10**. Coordinate C10!

Editing with the ESC Key

Earlier, we introduced the **CTRL C** command for completely erasing entry errors. The VisiCalc program has a less drastic way of correcting errors — the **ESC** key.

Press the following keys: **> A11** Then pause for a moment before pressing **Ⓡ**. Suppose that you intended to move the cursor to position A1, but you accidentally pressed the **1** key twice. You now have A11 on the edit line followed by the edit cue.

Press the key marked **ESC** once. Notice that the edit cue “backs up” by one character and erases the extra **1**, leaving you with A1. Now press **Ⓡ** The cursor will jump to entry position A1, and the prompt and edit lines will clear.

In general, the VisiCalc program will let you correct typing errors by backing up with the **ESC** key. You can also back up more than one character. As an example, let's change A11 to A2. Type **> A11** again. Press the **ESC** key twice, backing up to leave just the letter A. Then press the **2** key to get A2. Press **Ⓡ** It works!

Besides backing up, you can “back out” with the **ESC** key. Type **> B5** and then pause. Suppose that you change your mind and decide that you don't want to move the cursor at all.

Press the **ESC** key once, and the number **5** will disappear from the edit line. Press the key again. The letter **B** on the edit line disappears and so does the prompt **GO TO: COORDINATE**. You have backed out of the **>** or **GO TO** command completely, and you can now type something else. Backing out of a command with **ESC** is equivalent to typing **CTRL C** By the way, the beep sounded to tell you that your original command had been canceled.

While we're at it, let's review **CTRL C**. Press these keys: **> C12** Suppose you decide you don't want to use the **GO TO** command. Find the key labeled **CTRL** and press down on it. Hold it down while you type **C** Release **C** then **CTRL**.

CTRL C erased the prompt and edit lines. You have backed out of the **GO TO** command with **CTRL C**. No matter what you are typing, you can always back out and leave the worksheet unchanged by pressing the **ESC** key a few times or pressing **CTRL C** once, as long as you notice your error before pressing the last keystroke of the command or pressing **®**

Before going on, spend a few more minutes moving the cursor around with the arrow keys, and the **>** or **GO TO** command. Try moving the cursor to a nonexistent position such as **AB525**. What happens? Try moving to an invalid coordinate such as **25A** instead of **A25**. What happens?

Writing on the Electronic Sheet

As you have seen, moving the cursor and window around is pretty easy, but so far your electronic worksheet is (or should be) empty. You'll find that writing on the worksheet is even easier. Before proceeding type **/CY** to clear the worksheet.

The worksheet will disappear and then reappear with the copyright on the prompt line, your VisiCalc serial number on the edit line, and the direction indicator set to **-** for horizontal cursor motion. The **CLEAR** command completely erases the worksheet and resets the cursor's position to **A1**. See the **CLEAR** Command in Part III for details.

To begin, we will label a row. Type in the word **SALES** If you mistype a letter, you can press the **ESC** key to back up and make changes in the **SALES** label.

Stop and look at the prompt line. You should see the word **LABEL**. **LABEL** is the VisiCalc program's term for any type of message that won't be used in making calculations. On the edit line is the word **SALES** followed by the edit cue. The edit cue indicates that you can still use the **ESC** key to back up and retype the message or to back out completely. **SALES** also appears under the cursor at position **A1** on the worksheet.

When you are satisfied with your label, press the **↵** key. The information on the prompt and edit lines disappears, and the cursor moves over to position **B1**, leaving the label **SALES** at **A1**. You can use either arrow key **↵** **↶** instead of **®** to enter labels and values.

Now type in the numbers **100**

Stop and look at the status area again. The prompt line says **VALUE**. **VALUE** is the VisiCalc program's term for a number or formula. The number **100** followed by the edit cue appears on the edit line. Press the **ESC** key four times and watch the numbers disappear: first **0**, then **0**, then **1**, and finally the prompt, **VALUE**. Position **B1** is blank again. You can also perform this erasure by typing **CTRL C**

Now type in the formula **75 + 25**

If you make a typing error, watch the edit line carefully and use the **ESC** key to back up.

The word **VALUE** is again on the prompt line, and the edit line reads **75 + 25** followed by the edit cue. Press the **SHIFT** and the **1** key together to type a **!**, the exclamation point.

The VisiCalc program instantly calculates $75 + 25$ and shows the answer **100** on the edit line. You can use the "exclamation key" feature to perform quick calculations before writing a number on the worksheet. Much more will be said about formulas and calculations later.

Notice that nothing has appeared under the cursor at **B1**. Everything has happened on the edit line. Now press **Ⓡ**. The information on the prompt and edit lines disappears, and the number **100** appears at position **B1** on the worksheet. Pressing **Ⓡ** caused another change on the screen.

The entry line now reads **B1 (V) 100**.

The **entry line** gives a full explanation of the contents of the entry position highlighted by the cursor. Right now the entry line says **(V)** for Value and shows the number **100**.

Try pressing **ESC**. Nothing happens. Pressing **Ⓡ** told the VisiCalc program to consider **100** an actual entry. Press the **⬇** key, and the cursor will move back to position **A1**. Assuming a correct entry, the entry line reads **A1 (L) SALES**. The **(L)** stands for Label.

Formulas and Recalculation

Move the cursor down to position **A2** by pressing the **(S)** then **⬇** once. Enter the word **COST**. Press **(S)** once again and then press the **⬇** key. The cursor moves to **B2** leaving the label **COST** at **A2**.

We're going to write a formula for cost at **B2**. The formula will say that cost will be 60% of the number for sales or $.6$ times **100**. Instead of typing the **100**, however, we'll use its coordinates. Type in the formula **.6*B1**

The ***** symbol is used to indicate multiplication. The edit line should now display **.6*B1**. If it doesn't use **ESC** to correct any error. The formula is telling the VisiCalc program to multiply whatever is at coordinate **B1** by $.6$ (60%).

Now press **Ⓡ** and watch what happens. The information on the prompt and edit lines disappears. You should now see

B2 (V) .6*B1

on the entry line. And at position **B2** is the number **60**, the result of multiplying $.6$ times **100**, the number at **B1**.

Let's take a quick peek at the VisiCalc program's power. Press **(S)** and then the **⬆** key to move the cursor up to position **B1**. Watch the screen and type **200** **Ⓡ**. The new number (**200**) replaces the old number (**100**) at **B1**. What else happened?

Press the **↓** key to move the cursor to B2. The formula you had typed earlier, $.6*B1$, remains on the entry line at the top of the screen. When you changed the number at B1 to 200, the VisiCalc program automatically recalculated the formula at B2 as $.6*200$, or 120. Notice that cost is still 60% of sales. You'll see many more examples of this powerful recalculation feature as we progress.

More on Labels and Values

Let's look more carefully at Label and Value and explore an even simpler way to write formulas. As an example, we're going to write a formula that calculates gross profit by subtracting cost from sales. First we need to get the cursor into position to write a new label. Type **>A3** **Ⓜ** to move the cursor to coordinate A3. Press **(S)** to set the direction indicator to **-**.

To write the label, GROSS, press the **G** key. Notice that the prompt line immediately says LABEL. When you write at an entry position, the VisiCalc program looks at the first key you press to determine whether you are typing an alphabetic Label or a numeric Value. If you start with one of the letters A through Z, as you did here, the VisiCalc program assumes that you are typing a Label.

If you start with one of the digits 0 through 9 or a decimal point (**.**), or with something that could begin a formula such as plus (**+**), minus (**-**), open parenthesis (**(**), or **@** or **#** (which will be explained later), the VisiCalc program assumes that you are typing a Value. For now, press a **CTRL C** to get out of the Label mode.

What happens if you want to write a message such as **-GROSS-** or **1ST QTR**? Try typing in **-GROSS-** and watch what happens.

The VisiCalc program accepted the initial dash or minus sign to mean that you were typing a formula and the letter G as part of an entry position coordinate. However, it beeped an error message and refused further input when you typed something that couldn't be a formula. Press **CTRL C** to erase this entry.

In order to begin a label with a numeric symbol, we need to place a quotation mark at the beginning of the label. Type a **"** by holding down the **SHIFT** key while typing the **2** key. VisiCalc takes the **"** to mean that you want to type a Label. The quote symbol will not, however, appear as part of the message itself. As soon as you press the **"** key, the prompt line says LABEL, but does not show a character. The edit line only shows the edit cue. Now you can type **-GROSS-**

Do not use a closing quote symbol unless you want it as part of your label. If you ever want to begin a label with a quotation mark, you will have to type **"** twice. Now press the **↓** key. The cursor moves to position B3, leaving the message **-GROSS-** at A3.

Now we're ready to calculate SALES minus COST. The formula you'd expect would be **B1-B2**. What will happen when you type **B1-B2**?

Watch the prompt line as you type **B1-B2** and press **Ⓡ**. What happened? The prompt line showed that you were entering a Label, not a Value, as soon as you typed the letter B. B1-B2 is a perfectly legitimate message or comment, but it doesn't calculate anything. Only a Value (formulas included) can calculate.

Let's start again by eliminating the erroneous label B1-B2. Try pressing **ESC** and then **CTRL C**. Nothing happens because you've already pressed **Ⓡ**. To erase an entry after typing **Ⓡ**, you must use the VisiCalc command that blanks out entry positions.

Press the following keys: **/B Ⓡ**. The message B1-B2 under the cursor disappears, and the entry contents line goes blank except for the cursor coordinate B3. Note, however, that when you want to enter new information in a previously used coordinate, you can simply type in the new label or value without first blanking out the coordinate.

Remember that we used the " key to type a label when the VisiCalc program would otherwise have tried to treat it as a Value? We can use a similar trick to make the VisiCalc program accept the formula B1-B2 as a value instead of a label. One way to do this would be to type the formula as 0 + B1-B2. The VisiCalc program would take the initial digit 0 to signify that we were typing a Value.

An equivalent formula is + B1-B2. VisiCalc will take the + to indicate a Value. Type in the following formula for gross profit using the leading plus + B1-B2 Ⓡ

The entry line displays our formula as

VALUE: B3 (V) + B1-B2

The cursor rests on the number 80, the result of calculating + B1-B2 or + 200-120.

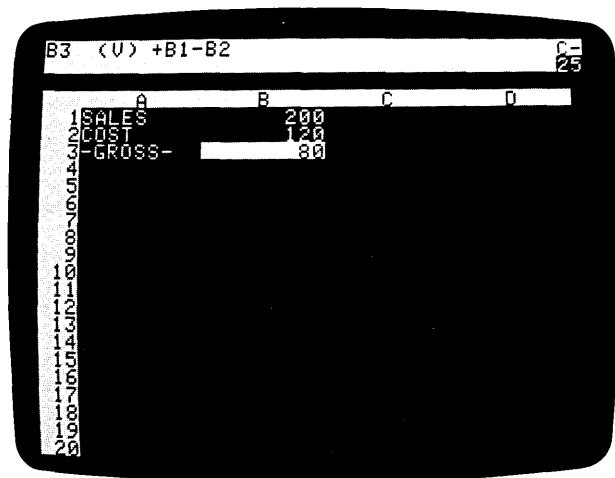

Cursor Moves in Formulas

So far, you know how to move the cursor to an entry position and how to write messages and numbers. You also know how to write a formula (such as $+ B1-B2$ in the previous example) that refers to other positions on the electronic worksheet. You have also seen that if you change the numbers at B1 or B2, the VisiCalc program will recalculate the formula $+ B1-B2$, and display the new result at the formula's coordinate, B3.

As you wrote the formula for sales minus cost, you probably had to check the screen to see that the number for sales was at position B1 and that the number for cost was at B2. Imagine what it would be like if you had already written a large number of formulas on the worksheet.

Keeping track of which numbers were at which coordinates could become time-consuming and somewhat confusing. Additionally, you might have scrolled columns A and B off the left edge of the window as you went on to work on other parts of the worksheet. That would leave you unable to see the numbers next to SALES and COST and would make writing a new formula involving sales and cost rather difficult. There's an easy way to solve this problem. You write the formula, but let the VisiCalc program fill in the coordinates! Let's try it.

Press the $+$ key. The prompt line reads VALUE, and the $+$ appears on the edit line followed by the edit cue. At this point, we would normally type the coordinate B1, but what we really want is the number next to the label, SALES, at coordinate B1 (currently 200).

Press (S) to set the direction indicator to $!$. Now point to the 200 on the screen with your finger. We are about to do the same thing electronically by "pointing" with the cursor.

Watch the edit line and press the \blacktriangleleft key once. The cursor moves up to highlight the number 120; the coordinate of that number, B2, appears on the edit line. Now press \blacktriangleleft again. Do you see what we mean by "pointing" the cursor? You have taken the cursor from its starting position at B3 and pointed it to B1 by placing it on B1.

The edit line now reads $+ B1$ followed by the small rectangle. Notice that these are the first three characters of the formula that you typed in earlier.

Press the $-$ key. The cursor jumps back to B3, the entry position at which we began writing the formula. The edit line now reads $+ B1-$ followed by the edit cue. As a general rule, after pointing the cursor at the position you want to include in the formula, you simply continue the formula by typing an arithmetic operation symbol such as $-$, $+$, $*$, or $/$.

Now let's enter the second part of the formula by pointing to it. Watch the edit line again and press the \blacktriangleleft key once more. The cursor moves up to 120, the number next to COST, and the edit line now reads $+ B1-B2$ — exactly the same formula as displayed on the entry line. This is the formula we want!

To enter the formula as it stands on the edit line, press \textcircled{R} . The information on the prompt and edit lines disappears.

You can see that the results of pointing to coordinates with the cursor are just the same as typing those coordinates in directly from the keyboard. The entry line still reads

B3 (V) + B1-B2.

The number on which the cursor rests is 80, the result of calculating B1 minus B2.

To demonstrate the VisiCalc recalculation feature again, press the \blacktriangleleft key twice to move the cursor up to B1. Change the number there by typing 100 $\text{\textcircled{R}}$ Notice that B2 changes back to 60 (.6 times 100), and B3 changes to 40 (100-60).

As a general principle, remember that whatever you see on the edit line you can type in from the keyboard. Likewise, any number or entry position currently on your worksheet can be pointed to instead of typed.

As you gain experience and familiarity with the VisiCalc program, you'll find that the technique of moving the cursor to the positions you want will become easier. In time, you'll find you can almost forget about coordinates entirely and think only in terms of the visual positions of numbers and formulas on the worksheet.

To test your understanding of the process of moving the cursor as you write formulas, you may wish to try an example yourself. Move the cursor down to position B5 and write a formula there for gross profit as a percentage of sales. Hint: the desired formula is $+ B3/B1*100$. Try to obtain this formula by moving the cursor and typing the + and / keys. Your screen should look like the photo below.

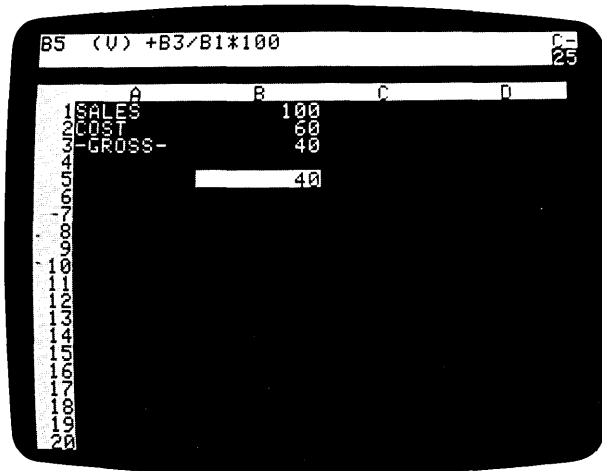

After you have obtained the result (40), keep the cursor at B5 and type $\text{\textcircled{B}}$. Then type $\text{\textcircled{>B1}}$ to place the cursor at B1.

More on Editing

Suppose we want to change the cost in the example we are working on from 60% to 55%. Place the cursor on B2. The entry line shows B2 (V) .6*B1. To change that formula type /E The prompt line reads [EDIT]: VALUE (because the entry is a value). The formula .6*B1 is displayed on the edit line with the edit cue (the flashing white box) over the first character, the decimal point. We want to change .6 to .55. Press \blacktriangleright twice to move the edit cue over the *, just to the right of the part we want to change. Nothing changes but the position of the edit cue. Now press **ESC** once. This works just like it did when we erased with the ESC key before. The edit cue backs up one space and erases the 6. The edit line now reads .5*B1. Type **55** the edit line reads .55*B1 — the formula we want. Press **Ⓡ** The prompt and edit lines clear and B2 (V) .55*B1 appears on the entry line. The number at B2 has changed to 55.

Pressing **ESC** will erase the character just to the left of the edit cue. Typing a character will put that character on the edit line just in front of (to the left of) the edit cue.

Try changing the cost back to 60% of the sales. Type /E \blacktriangleright \blacktriangleright \blacktriangleright **ESC ESC 6 Ⓡ** to return the sheet to where we started.

The Edit Command operates in two ways. Typing /E will let you edit the contents of any position on the sheet. Typing **CTRL E** while the edit cue is still on the edit line will let you edit what is on the edit line.

You can use these same editing features on anything you are typing in on the edit line. Type >**A6Ⓡ JANUARY PROFIT MARGIN** Suppose you need the profit margin for February instead of January. Press **CTRL E** by holding down the **CTRL** key and pressing **E**. This time the prompt line reads [EDIT]: LABEL because we are entering a label. Press the \blacktriangleleft key until the edit cue is resting just to the right of the Y. Press **ESC** seven times to erase JANUARY and Type **FEBRUARY** If you were to press **Ⓡ** you would have FEBRUARY PROFIT MARGIN entered at A6. For now, return to the original sheet by typing **CTRL C >B1Ⓡ** For more information on the Edit Command see Part III, the EDIT Command.

Saving the Electronic Worksheet on Diskette

By saving the work you have done in this lesson, you can carry it over into Lesson Two. Begin by taking out one of the diskettes that you initialized earlier. If you haven't initialized any diskettes yet, you can return to the Introduction and follow the instructions in Part I, "Initializing VisiCalc Storage Diskettes". The /SI command won't disturb the information you have written on the electronic worksheet.

If you don't have any extra diskettes, it's okay. Lesson Two gives brief instructions for setting up the electronic worksheet with exactly the same labels, numbers and formulas which you have now. We do recommend, however, that you skim over the material below and at the beginning of Lesson Two on the /SS and /SL commands.

To save your worksheet, first make sure that your Disk II IN USE light is off. Open the door of the drive. If your VisiCalc program diskette is still in the drive, carefully remove it, put it back in its paper sleeve, and replace it in the front pocket of the VisiCalc binder.

Insert the diskette you have chosen for storing this worksheet. Gently push the diskette all the way in (label side up, entering last) and close the Disk II door.

Now type **IS** (the VisiCalc STORAGE command). The prompt line should read

```
STORAGE: L S D I Q #
```

The VisiCalc program is telling you that it recognized **IS** as the Storage command and that it expects you to choose from one of six forms of the storage command by pressing one of these keys: **L S D I Q #**. These keys are command symbols:

- L** **Load** the worksheet contents into RAM memory from a diskette file.
- S** **Save** the sheet in memory by "writing" it into a diskette file.
- D** **Delete** a previously saved file from its place on the diskette.
- I** **Initialize**, or format, a blank diskette.
- Q** **Quit** the VisiCalc program and load a new program from drive 1.
- #** **Save or load a worksheet in the Data Interchange Format** (see Part III, the STORAGE Command).

Press the letter **S** and STORAGE: FILE FOR SAVING will appear on the prompt line with the edit cue on the edit line. Because each diskette has enough room to hold several electronic worksheets, each worksheet on the same diskette must have a unique name. In this way, you can find the worksheet at a later time and load it back into the computer.

The saved information is called a diskette **file**, and the name that identifies the file is called a **file name**. Because we've been studying an example, let's save our work with the file name EXAMPLE.VC. (.VC will let you recognize this file as a VisiCalc worksheet. See Part III, FILE NAMES)

The VisiCalc program will find an empty area on the diskette and will write the worksheet contents there. The VisiCalc program will also save the file name in the diskette's **directory** along with the file's address on the diskette.

There are a few simple rules for creating a valid file name. A file name can be up to thirty characters in length. The first character must be a letter. The comma (,) and ® (or **CTRL M**) are the only characters which you cannot use. Be careful, however, with control characters, **ESC**, **◆**, and **◆**; they will not be visible and can produce strange results.

If you have your storage diskette in a drive other than drive 1, you must add a **suffix** to the file name. The suffix can consist of two parts — a slot designation (indicating which slot your Disk II controller card is in) and a drive designation (which tells VisiCalc the drive in which your storage diskette is located).

For example, if you want to designate drive 2, you would type **,D2** after the file name. If you had connected that disk to a controller card in slot 5, you would type **,S5,D2** after the file name. Note the use of the comma, with the suffix. The comma separates the suffix from the file name and the slot number from the drive number. Be sure to include it when adding a suffix.

Once you designate drive 2, the VisiCalc program saves your worksheets to and loads them from drive 2 and ignores drive 1. In this case, drive 2 is said to be the "default" drive. To return default to drive 1, you must use the suffix **,D1**. The same principle applies to slot numbers. For more information on file names and suffixes, see **FILE NAMES** in Part III.

Let's go ahead and name the file we are saving **EXAMPLE**. You should have the blank, initialized diskette you're going to use in drive 1. We want to tell the VisiCalc program to save the file on the diskette in that drive. Type in the file name **EXAMPLE.VC**. As usual, you can correct typing errors with the **ESC** key. After typing the file name, **EXAMPLE.VC** press **Ⓜ**.

The disk drive should begin whirring and the **IN USE** light should come on. After a moment, the drive should quiet down, the **IN USE** light will go off, and the prompt and edit lines will go blank. Your work is safely filed away on the storage diskette.

This completes Lesson One. You may wish to experiment for a while, moving the cursor around and writing your own labels, numbers and formulas. Try writing some formulas by pointing the cursor to obtain the coordinates. The VisiCalc program has many more features we haven't discussed yet, and you may stumble upon one of them.

If something happens that you don't understand, make a note of it and then continue with the next lesson. Most of your questions will be answered as you go. You already know enough about the VisiCalc program to use it for some simple applications. Try it!

The RESET Key

NEVER press the key marked **RESET** unless you want to return your Apple II to a startup condition. **RESET** will interrupt the normal program operation, you will need to reload the VisiCalc program. The process of reloading will erase the worksheet. However, if you press **RESET** by mistake, you can salvage your worksheet before reloading the VisiCalc program.

If your Apple II has the Autostart ROM feature, go on to the steps below. If your Apple II does not have the Autostart ROM feature (pressing **RESET** will put an asterisk and a blinking box on the screen), you must type **CONTROL Y RETURN** before continuing. Hold down **CTRL** while pressing **Y**. Release the two keys and press **Ⓡ**. Now follow the steps below.

- 1) If you don't have a storage diskette in your drive, insert one now. If you haven't initialized a storage diskette yet, insert a blank diskette into the drive.
- 2) Type **/S**
- 3) If you need to initialize a storage diskette, press **I**. Once the diskette has been initialized type **/S** again.
- 4) Press **S**. The prompt line will read
STORAGE: FILE FOR SAVING
and the edit cue will appear on the edit line. The VisiCalc program is prompting you for a file name.
- 5) Type in a file name, such as **EMERGENCY SAVE** and press **Ⓡ**

The drive will activate and save your worksheet. Once the **IN USE** light goes off, remove the storage diskette and insert the VisiCalc program diskette. Load the VisiCalc program, then load the worksheet you saved by typing **/SL** and the file name (**EMERGENCY SAVE**). Finally, press **Ⓡ**. Your sheet will appear on the screen just as it was before you hit **RESET**.

Note: If you need to remove a file from a diskette to save your worksheet, you can use the Delete command, **/SD** in place of the initialization command. See Part III, the **STORAGE** Command for detailed information on saving, loading, deleting, and storing information.

Postscript: Protecting Your Work

Have you ever worked out a problem or made some notes to yourself on a sheet of paper only to find out later that the sheet had been lost or that someone had accidentally thrown it away? Or perhaps you've lost the results of some calculation you were performing on an electronic calculator because power was turned off or the battery died. Things can and do go wrong.

As you begin to use the VisiCalc program, you'll find that at times the results you see on the screen may be quite important to you. Losing that information at the wrong time would be at best a real nuisance, and at worst, something of a disaster. How can you protect yourself against such losses?

The VisiCalc program does its best to protect you. For example, if you give the command to clear the screen (intentionally or accidentally) by typing **/C** the VisiCalc program will display **CLEAR: TYPE Y TO CONFIRM** on the prompt line. Only if you type the letter **Y** at this point will the contents of the worksheet be erased.

If you type any other key, the **CLEAR** command will be aborted, and the worksheet will be left unchanged. Similarly, if you type **/B** to blank out an

entry, nothing will happen until you press one of the keys **↵** **↩** or **®** . Any other key will abort the **BLANK** command.

However, things beyond the VisiCalc program's control can go wrong. What if your building has a power failure? What if someone pulls the plug from the socket? What if you are called away by some emergency, and the janitor turns off your computer?

To protect yourself, you should **save the electronic worksheet periodically on diskette**. As you work, think of how long it has been since you last saved the worksheet. If you have spent more time than you would wish to lose if something went wrong, or if you have new results which might be difficult to reconstruct, then it's time to save the worksheet again.

To keep track of several versions of the same information on diskette, you can add a sequential number to the file name you use when you save the worksheet. Thus, the file name, **FORECAST1.VC** might become **FORECAST2.VC**.

Printing out your worksheets is another security measure. The **PRINT** Command in Part III gives details on how to print out the data on the worksheet, but not the formulas and formats "behind" the data. See Part III, the **STORAGE** and **PRINT** Commands, for information on the **/SS,S** command that prints out only worksheet formulas and formats. With these two documents in hand, you have a complete "hard copy" of your work.

Saving your work periodically on diskette is only the first step in protecting yourself. A diskette is a safe and reliable medium for storing information.

However, a diskette can be harmed even in ordinary use. A diskette may be scratched, or it may pick up grease or dust. It may be damaged by heat, exposed to a magnetic field, or accidentally re-initialized, thus erasing its contents. And a diskette will eventually wear out. Its average lifetime is about 40 hours of use (whenever the **IN USE** light is on, the diskette is in use). To protect yourself, you should always make extra copies of your important files on separate "backup" diskettes.

To make a backup copy of your files, you can use the VisiCalc **STORAGE** command. Simply insert the diskette containing the file you want to copy into drive 1 (or whatever drive you are currently using). Then type **/SL** to load the worksheet from the diskette file into memory. Remove the first diskette and insert an initialized storage diskette into the drive and use the **/SS** command to save the same information on the new diskette.

For details on the **/SL** and **/SS** commands, see Lesson Two and the **STORAGE** Command in Part III. The time it takes to make backup files will be amply repaid the first time you try to load a file from a diskette, only to get the message that an error occurred while trying to read the disk.

Alternatively, you can copy the entire contents of one diskette to another diskette. See *The DOS Manual* for details on how to run your System Master diskette's **COPY** program.

Test your understanding of the procedures on a data diskette you make expressly for experimentation. Until you thoroughly understand the procedures, don't risk diskettes with important data on them; you may lose the data while learning.

Making backup files is important. It's all too easy to read about these protective measures, use them once or twice, and then when you're in a hurry, skip the backup steps. Remember Murphy's Law: If anything can possibly go wrong, it will. Protect yourself.

Lesson Two

In this lesson, you will learn how to extend the basic principles behind the VisiCalc program learned in Lesson One by applying them with new commands. We will begin with the example built up in Lesson One, showing a figure for sales, and formulas to calculate cost of goods sold and gross profit.

If you have just finished Lesson One, everything you need should still be present on the electronic worksheet. Check your screen against the screen photo below and continue with the text from that point. If you want to practice loading the worksheet you just saved anyway, type /CY and then follow the instructions in the next section.

If you're tackling Lesson Two in a new session, your first step is to load the VisiCalc program into your computer's memory. To do this, follow the instructions in Part I entitled "Loading VisiCalc."

If you saved the results of Lesson One on diskette, you can easily reload the same information by following the instructions below.

If you didn't save EXAMPLE on diskette, you can type it in. To practice moving the cursor as well as writing labels, numbers, and formulas, you can go through the steps in Lesson One. Or you can type exactly the characters you see below. Remember you may have to use the **SHIFT** key to type some of the characters. Make sure your direction indicator reads - (if it doesn't just press (S) Begin by positioning the cursor at entry position A1.

```
>A1 ®  
SALES ♦ 100 ®  
>A2 ®  
COST ♦ .6*B1 ®  
>A3 ®  
" -GROSS- ♦ + B1-B2 ®  
>B1 ®
```

Compare what you have on your screen with the following photo. If everything looks fine, go ahead with the section after the photo, "Replicating a Formula."

Loading the Sheet from Diskette

Make sure that your disk drive's IN USE light is off, then open the door and (if you haven't done so already) carefully remove your VisiCalc program diskette and replace it in the pocket on the inside front cover of this manual. Take out the storage diskette onto which you saved the file, EXAMPLE.VC and insert it into drive 1. Be sure that the label on the diskette jacket is up and on the side of the diskette nearest you. Gently push the diskette all the way in, and close the drive door.

Now type the VisiCalc STORAGE command **/S**. The prompt line reads
STORAGE: L S D I Q #

To review the meanings of the characters L S D I Q #, check the section entitled "Saving the Electronic Sheet on Diskette" at the end of Lesson One.

Press **L**. The prompt line reads FILE TO LOAD. At this point, you could simply type the name EXAMPLE.VC and press the **Ⓡ** key. But let's try something else. We will **scroll** the file names from the storage diskette.

Press the **⬇** key once. Your Disk II will whir for a moment and the IN USE indicator light will come on as the VisiCalc program looks at the directory. Then the name EXAMPLE.VC will appear on the edit line. If a different name appears, press the **⬇** key repeatedly until you see the name EXAMPLE.VC. If the file you're looking for is not on the diskette, you will eventually scroll through all the file names on the diskette and out of the **/SL** command. For more information on the scrolling, see Part III, FILE NAMES.

Assuming that you have EXAMPLE.VC on the edit line, press **Ⓡ**. On the prompt line you will see STORAGE: LOADING followed by a flashing asterisk. Once the loading process ends, your screen should resemble the photo below.

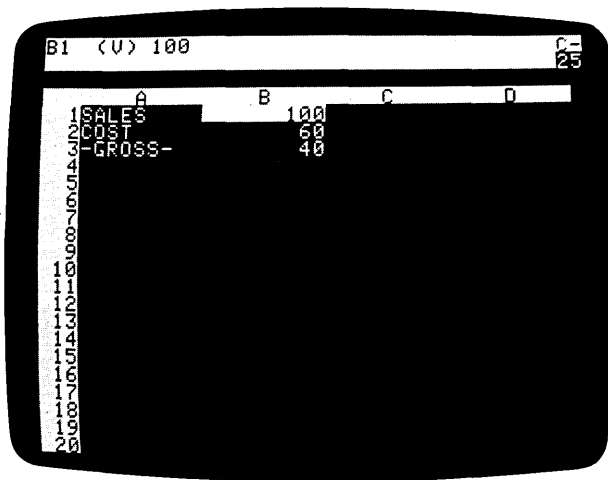

Replicating a Formula

Your screen should look exactly like the one pictured above. The cursor should be at B1. If not, type **>B1** **Ⓜ** If the number at B1 is not 100, just type **100** and press **Ⓜ** Be sure the direction indicator is set to –

At present, we have figures for sales, cost of goods, and gross profit for only one period (such as a month or year). Now, we'll project these figures out for twelve months.

Let's begin by assuming that sales will increase by 10% each month. Press the **⬇** key to move the cursor to C1 and type **1.1*** **⬇** **Ⓜ**

Notice that we used a cursor movement to put the coordinate B1 in the formula for the next month's sales. The entry line at the top of the screen now reads

C1 (V) 1.1*B1

and the number under the cursor at C1 is 110, which is equal to 1.1×100 .

To calculate sales for the remaining ten months, we would have to move the cursor to D1 and type the formula $1.1 \times C1$ and then move on to E1 and type $1.1 \times D1$ and so forth. Since this is such a common operation and it requires so many keystrokes, the VisiCalc program provides a shortcut.

That shortcut is the REPLICATE command, and it can be used to make copies of, or to "replicate" formulas, labels, numbers, blank entries, etc. across columns, down rows and so forth. In this lesson, we'll use the replicate command in some simple examples. The many uses of this command are explored more fully in Lesson Three.

With the cursor at C1, type **/R** to enter the REPLICATE mode. The prompt line reads

REPLICATE: SOURCE RANGE OR RETURN

The edit line shows C1, the coordinate of the formula on which the cursor rests, followed by the edit cue. Our "range" will be only one formula as the source (not a range of two formulas). Press **Ⓜ** to select C1 as the single item to be replicated.

The prompt line now reads REPLICATE: TARGET RANGE.

The edit line reads C1 . . .C1: followed by the edit cue. We've told the VisiCalc program to REPLICATE the formula at C1 (with the **/R** command). Now the VisiCalc program needs to know *where* (the "target range") we would like it replicated (copied) on the worksheet.

Our intent is to project sales out for twelve months. The first month is shown at B1, the second at C1, and the twelfth month will be at M1. Hence, we want the formula replicated in the target range of positions from D1 to M1.

Press the **⬇** key to set the beginning of the target range at D1. Now type a period to tell the VisiCalc program that the next coordinate will be the second part of the target range. If you don't type the period, every press of

the \blacktriangleright will change the beginning coordinate of the target range. The period acts as a delimiter and produces three periods (an "ellipsis") following D1. The edit line now reads

C1 . . . C1: D1 . . .

As you can see, by moving the cursor, we are indicating where we want copies of the formula to be placed. Now press the \blacktriangleright key ten times (until the cursor rests on M1). Notice that as you move the cursor to D1, E1, F1, etc., the "target range" on the edit line expands accordingly

D1 . . . D1, D1 . . . E1, D1 . . . F1,

The VisiCalc program is "filling in" the ending coordinate of the target range, just as it did when we moved the cursor in the middle of typing a formula.

When you have finished pressing the \blacktriangleright key ten times, the cursor will be resting at M1, and the edit line will read

C1 . . . C1: D1 . . . M1

If you moved too far with the \blacktriangleright , you can move back with the \blacktriangleleft . Now press \textcircled{R} . The cursor jumps back to C1, where the original formula is stored. The edit line reads

C1: D1 . . . M1: 1.1*B1

The edit cue is highlighting the coordinate B1 on the edit line. The prompt line reads

REPLICATE: N = NO CHANGE, R = RELATIVE

The VisiCalc program is asking whether you want the same formula, 1.1*B1, at each of the positions in the target range D1 . . . M1, or whether the coordinate B1 should be interpreted as *relative* to the position of the formula.

We want to show sales increasing by 10% in each month, so we want the formulas to be 1.1*B1, 1.1*C1, 1.1*D1, etc. In other words, we want the formula to be *relative*. That is, each new sales figure should be 1.1 times the previous month's sales.

Now watch the edit line as you press the letter **R**. The information on the prompt and edit lines disappears. The cursor remains at C1, where we started, and numbers appear in the visible columns.

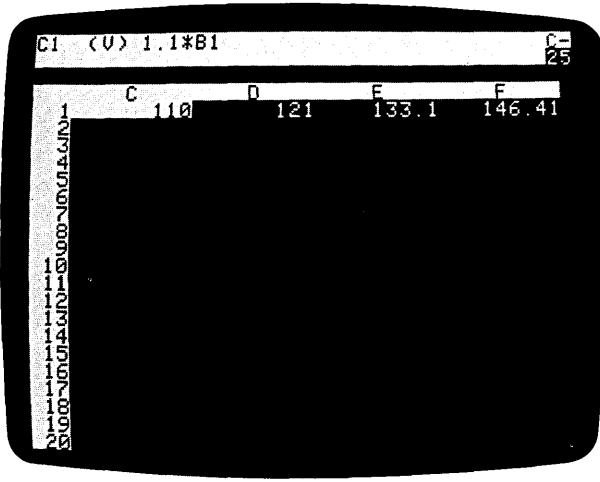

Use the **↓** key to move the cursor to D1, E1 and F1, and notice what appears on the entry line.

1.1*C1, 1.1*D1, and 1.1*E1

Press the **↓** key seven more times to move the cursor over the entries G1 through M1, scrolling the window to bring them into view. The VisiCalc program has “typed” the formulas for you and calculated the sales values for all twelve months. At M1, the twelfth month’s sales should be shown as 285.3117 (to four decimal places).

We will cover other Replicate options in succeeding chapters. For the present, however, remember these five easy steps for replicating a formula:

- 1) Position the cursor at the entry position you want to replicate.
- 2) Press **/R** to start the replicate command.
- 3) Press **Ⓜ**
- 4) Point the cursor at the first entry position in the range of positions where you want the formula replicated, press **.** and point to the last entry position (or you can type in the entry coordinates).
- 5) For each coordinate in the formula, press either **N** or **R**, depending on whether that coordinate should be left unchanged or interpreted as relative to the position of each copy of the formula.

Replicating a Range of Formulas

Type **>A2** Ⓜ to jump back to the left edge of the worksheet and then press ⏏ to move the cursor to B2. To complete our twelve month projection, we would like to replicate the formulas for cost of goods sold and gross profit. At the moment, the entry line shows the formula for cost of goods, $.6*B1$. If we were to move the cursor to B3, we would see the formula for gross profit, $+B1-B2$. Our next project is to replicate both of these formulas simultaneously across the worksheet.

Press **/R** The prompt line reads

REPLICATE: SOURCE RANGE OR RETURN

and B2 is on the edit line followed by the edit cue. If you were to press Ⓜ at this point, as we did before, you would replicate just the formula for cost of goods sold at B2. When you were finished, you would come back to the formula for gross profit at B3 and replicate it into the same range of columns as you did for B2. We can accomplish both of these steps at once. Type **.B3** Ⓜ The edit line now reads

B2 . . . B3:

VisiCalc acknowledges that we want to replicate a "source range" of formulas, B2 through B3, instead of just a single formula. The prompt line reads

REPLICATE: TARGET RANGE

Instead of pointing at the first and last positions as we did before, we will type the coordinates of the target range. Type **C2.M2** Ⓜ

For a source range of B2 . . . B3, and a target range of C2 . . . M2, the VisiCalc program will assume that the formula at B2 (for cost of goods) is to be replicated at positions C2 through M2, and the formula at B3 (for gross profit) is to be replicated at positions C3 through M3.

The prompt line now reads

REPLICATE: N = NO CHANGE, R = RELATIVE

and the edit line reads

B2: C2 . . . M2: $.6*B1$

with the edit cue over the coordinate B1.

How do we want the formula at coordinate B1 to be interpreted? Our intent is that cost of goods sold in any given month will be 60% of that month's sales. Therefore, we want B1, the coordinate for SALES, to be interpreted as *relative* to the position of each copy of the formula. For the formula at B2, we want the sales figure just above it, or B1. For the formula at C2, we want the sales figure just above *it*, or C1; and so on.

Press **R**. Almost instantly, numbers appear in the other columns, and the edit line now reads

B3: C3 . . . M3: + B1

with a highlight over B1. The VisiCalc program is ready to replicate the formula for gross profit, at B3, into positions C3 through M3. The + B1 is the beginning portion of the formula + B1 - B2. Again, we want B1 to be interpreted as relative to the position of each copy of the formula.

Press **R** again. Now the rest of the formula appears on the edit line, as + B1 - B2. This time the edit cue appears over B2. B2, the cost of goods, is also relative in the gross profit formula. Press **R** once more. Numbers will appear in the other columns of row 3, and the prompt and edit lines will go blank. The REPLICATE command has finished its work.

	A	B	C	D
1	SALES	100	110	121
2	COST	60	66	72.6
3	-GROSS-	40	44	48.4
4				
5				
6				
7				
8				
9				
10				
11				
12				
13				
14				
15				
16				
17				
18				
19				
20				

Use (**S**) and the arrow keys to move the cursor to the right and up and down to examine the formulas and calculated results displayed in columns C, D, E and so on. Finally, type **>M1 ®** to get to the last month's sales, cost of goods and gross profit, in column M. The VisiCalc program has saved you a good deal of work already. But these numbers are somewhat hard to read, because they fill the columns and don't always line up. Can we do better than this? Of course.

Formatting the Screen Display

We can change the whole worksheet (a "global" change) to an integer (or whole number) format. Type **/GFI** (for "Global Format Integer"). If you scroll the window to the left, you will see that all of the numbers on the worksheet have been rounded to integers and lined up on the right side of each column.

However, this does not mean that the VisiCalc program has actually rounded the numbers that it uses in its calculations. Each number is calculated and maintained with up to eleven (and sometimes twelve) significant digits or decimal places. Therefore, each new period's sales is based on an accurate version of the previous period's sales, rather than on the figures as *displayed*. The numbers are rounded *only* for display, not calculation purposes.

Perhaps you'd prefer to see two more decimal places, for "dollars and cents." Press **I** (the keystroke which starts all commands). The prompt line reads

COMMAND: BCDEFGIMPRSTVW –

Each of the keys, B, C, D, and so on through " – " is a keystroke for a different command.

So far, we have seen the commands **/B** (for BLANK), **/C** (for CLEAR), **/R** (for REPLICATE), and **/S** (for STORAGE). Now press **G**. The prompt line reads

GLOBAL: C O R F

The VisiCalc program has recognized the GLOBAL command. The GLOBAL command changes some aspect of the entire screen display. What we want now is a GLOBAL change of all numbers from an integer to a "dollars and cents" format. To do this, you must select one of the GLOBAL choices the VisiCalc program is offering you — C, O, R or F. Press **F** for Format. Now the prompt line reads

FORMAT: D G I L R \$ *

The VisiCalc program is ready to change the screen format (the way in which numbers and labels are displayed on the screen) over the entire worksheet.

A moment ago, you used the letter **I** to change all of the numbers to integer format. This time, type **\$**. And remember, you can use the **ESC** key to correct typing errors or **CTRL C** to quit the command and start over. Notice how the screen display changes to show everything in dollars and cents form.

The FORMAT prompt list (D G I L R \$ *) offers ways to format numbers and alphabetic labels. You can, for example, set the format of each entry position individually, instead of globally. These options will be covered more fully in lessons Three and Four of this Tutorial.

Fixing Titles in Place

If the cursor is not on M1, type **>M1** Ⓜ. Only the numbers for each month's sales, cost of goods, and gross profit are shown on the screen. The titles SALES, COST, and -GROSS- have scrolled off the screen window to the left.

Imagine the situation if you were preparing a more complex income projection, with many rows of numbers for selling and administrative costs, taxes, and so on. It would be difficult to remember what each row of figures

represented, once the titles had scrolled off the screen. So, let's look at a way to keep our left edge titles visible, no matter how far we scroll to the right.

First, put the cursor back to the left edge, where the titles are. Type **>A1** **®** to bring the titles SALES, COST, and -GROSS- into view. Now invoke the TITLES command by typing **/T**. The prompt line says TITLES: H V B N. The possible keystrokes are:

- H** To fix **H**orizontal titles.
- V** To fix **V**ertical titles.
- B** For **B**oth horizontal and vertical.
- N** For **N**either.

Press the letter **V** to tell the VisiCalc program to fix the vertical column A, where the cursor lies, in its present position, as the left hand column of the screen. Set the direction indicator to **-**. Watch the screen and press the **◆** key eight times. Notice that column A stays fixed in place while the remaining columns scroll to the left, disappearing when they reach column A.

Now press the **◆** key nine times. If you aren't sure what happened, press the **◆** key again. You are "bumping" into column A, just as you bumped into the left edge of the worksheet earlier. Next type **>M1** **®**. Column A is still visible, making it easy to identify each row of numbers.

	A	K	L	M
1	SALES	235.79	259.37	285.31
2	COST	141.48	155.62	171.19
3	-GROSS-	94.32	103.75	114.12

Now for a Quick Recalculation

So far, with the aid of the REPLICATE command, you have written one number (the beginning number for sales at B1), and thirty-five formulas on the electronic worksheet. How are these formulas related? Press **>B1** **®** to bring the first columns into view, leaving the cursor on the initial SALES figure.

The formula for cost at B2 is $.6*B1$, which depends on the figure for sales at B1. The formula for gross profit at B3, in turn, depends on both sales and cost ($+ B1 - B2$). What about succeeding columns? At C1, the formula is $1.1*B1$, so this entry also depends on the initial sales figure. And cost of goods at C2 depends on the figure at C1, while C3 depends on both C1 and C2. At D1 we have $1.1*C1$, and so on.

As you can see, a change to the initial sales figure at B1 will affect every other number on the worksheet. Try it. Just type a new number, such as **123.45**, and press **Ⓜ**. How long did it take to recalculate twelve months' worth of sales, cost of goods and gross profit formulas? Type **100 Ⓜ** and watch the changes ripple through the other figures on the screen. Scroll the screen window to the right to view M1, the ending month's sales.

At this point, you might be wondering how to change the percentages themselves — sales growth figure of 10% or the cost of goods percentage of 60% — to recalculate gross profit. For simplicity's sake, we've designed this example so that the only changeable figure is the initial value for sales. Since the figures 1.1 and .6 are built into each of the twelve formulas for sales and cost of goods, we can't change these percentages without replicating all of the formulas again.

A better approach would be to write the factors 1.1 and .6 into separate positions on the worksheet, and make the sales and cost of goods formulas refer to these positions. If we did this, changing the sales growth and cost of goods percentages would be as easy as changing the initial sales. We'll make use of techniques like this in Lesson Three in an example related to personal budgeting.

Adjusting Column Widths

For some time now, you've been scrolling the window back and forth across the worksheet to view the figures for different months. To eliminate some of this scrolling, we can make the columns smaller and be able to see more columns on the screen. Type **>B1 Ⓜ** to return the cursor to coordinate B1.

Type another GLOBAL command to change the column width to 7 characters: **/GC7 Ⓜ**. In an instant, the screen changes to display more columns. Each column has been narrowed from nine characters to seven characters in width.

In general, you can use the command **/GC** to set the "Global Column width" to anywhere from 3 to the maximum number of characters for your screen. Given a column width, the VisiCalc program will fit as many columns as it can across the screen. Note that you can only set column widths **globally**, not individually.

Right now, the dollars and cents figures just about fill up the available space in these 7-character columns. Type **/GFI** to round these numbers to integers. Now that we have some extra space, we can narrow the columns further.

Type **/GC4** ® That gives us even more columns of figures in the window, with each column being four characters wide and displaying three digits.

The VisiCalc program leaves an extra character blank to the left of each value. This "reserved" space has been included to keep the display from running values together. Labels, however, do not have this extra space.

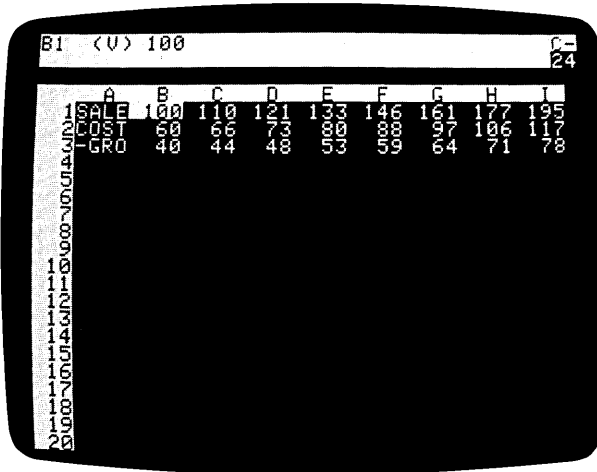

Look at the titles, SALES, COST, and -GROSS- in column A. SALES has been shortened to SALE and -GROSS- is now -GRO. Have we lost the rest of the labels SALES and -GROSS- ? Type **>A1** ® to move the cursor to position A1 to find out. If you had pressed the **↵** key to get to A1, you would have bumped into column A, which we fixed as a title area.

Note that though the label at A1 still reads SALE, the entry line above reads A1 (L) SALES. Set the direction indicator to ! and press the **↵** twice to reach A3. The entry line again displays our true label

A3 (L) -GROSS-

Even though the columns have been narrowed, the full alphabetic labels are preserved.

These labels can be more than nine characters long. In fact, you can type an alphabetic label as long as you like, regardless of the current column width, and the full label will be preserved. With the cursor still at A3, type **GROSS PROFIT** Then press the **↵** key to move up to COST and type **COST OF GOODS SOLD** ® Finally, type **/GC12** ®

Notice that the entire label GROSS PROFIT comes into view while the number of columns in the window is reduced. Now type **/GC18** ® Notice the prompts GLOBAL: C O R F and COLUMN WIDTH, and the edit cue on the edit line as you type. As usual, the **ESC** key can be used for corrections as you enter the number 18. The entire label COST OF GOODS SOLD can be seen. Type **/GC7** ® to return to the standard column width.

The VisiCalc program makes all columns in a window the **same** width. You can only have different column widths if you split the screen (see below).

If you want to *display* a label longer than the current column width but still have the narrow column width for numbers, you can enter the label in two or more columns.

For example, if you wanted to display the label COST OF GOODS SOLD beginning in column A (set to a column width of nine characters), you would type

COST OF G OODS SOLD ®

The label is displayed in columns A and B. You can no longer use column B for numbers and formulas.

The ability to fix titles in place and adjust column widths gives us some compensation for the limited size of the screen. But suppose we wanted to do two things at once:

- 1) Keep the wider columns and the cursor at B1 (the initial sales figure); and
- 2) Change that figure, while watching what happens to the final sales and gross profit in column M.

If only we had two screens

Splitting the Screen

Type **>E1 ®** to move the cursor to column E. Now, type the WINDOW command **/W** The prompt line reads

WINDOW: H V I S U

Press **V** for Vertical. Your screen should look like the photo below.

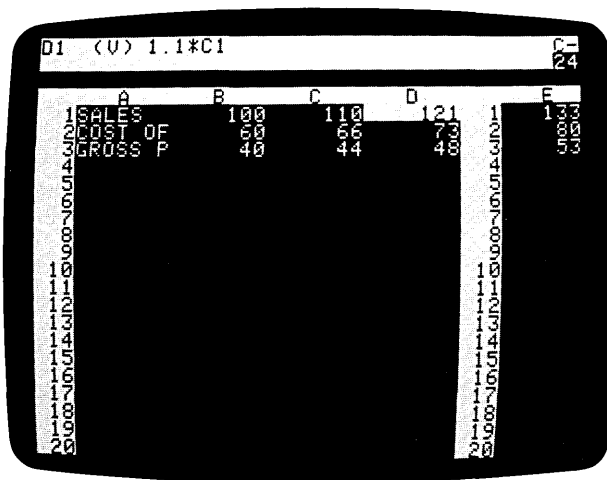

You have created two screen windows. Each one can be scrolled independently to view any portion of the electronic worksheet. At present, the cursor is in the left window. Make sure the direction indicator is still ! and use **↓** and **REPT** to move the cursor downwards to row 21 and beyond. The left window will scroll downwards to follow the cursor, but the right window will remain still. Bring the left window back to the top of the worksheet with **>B1** **Ⓜ**

You may have noticed that the column widths that we set earlier have changed in the right window. The VisiCalc program must sometimes narrow these widths to accommodate the extra border that split windows add to the screen. Whether the VisiCalc program narrows columns or not depends on width requirements. See the WINDOW Command in Part III for further details.

Press the semicolon (;) key to jump the cursor into the right window. Press **(S)** to set the direction indicator to -. Press **↓** and **REPT** to scroll the right window across to column M. We now have both the beginning and ending months' sales, cost of goods and gross profit figures visible at the same time.

Press ; again. The cursor jumps back to the left window. Each time you press the ; key, the cursor jumps from one window to the other. Notice that the cursor has landed at the same position it was on when we last jumped out of the left window. Note too that the direction indicator is now !.

Now we can change the initial sales figure and watch what happens in the final month. Type **123** **Ⓜ** and let the VisiCalc program recalculate. Notice that during recalculation the "C" in the upper right corner of the screen flashes.

SALES in column M should be 351. Try typing a few more numbers with the cursor at B1. See if you can find, by trial and error, the initial sales figure that yields twelfth month sales of 1000 (rounded to the nearest integer). Hint: you can type a number with a decimal point, even though it will be displayed in rounded form.

When you finish experimenting with recalculation, type the WINDOW command **/W** and the numeral 1 for one window, the normal screen. We have seen that the idea of a split screen is useful. Can we get any more mileage out of this approach? Take a look at the screen, and notice how much of it is empty. Perhaps we can use the lower part of the screen to better advantage.

Type >B11 Ⓜ to move the cursor down to the middle row of the screen. Now type /WH (for horizontal). Your screen should look like the photo below.



This time the screen is split horizontally into a top and bottom window. Press the ; key to move the cursor into the bottom window. Next press ⏴ and REPT to scroll the bottom window upwards until the cursor bumps into the top edge of the worksheet. Both windows are now displaying the same portion of the electronic worksheet!

The cursor should be at B1 in the bottom window. Change the number at B1 to 100 in the bottom window, and watch what happens. The recalculation affects both windows. Press (S) to set the direction indicator to -. Use ⏴ and REPT to scroll the bottom window to the right until column M comes into view. Now you can see the figures for the first and the last months at the same time.

Global Commands in Separate Windows

The VisiCalc program allows you to have different column widths in each window. To accomplish this, press ; to move the cursor into the top window. Now type **IGC4** ® to change the upper window column width to four characters, while the lower window retains a width of seven characters.

Always remember that the global commands **IGC** and **IGF** affect *only* the window in which the cursor rests at the time the command is typed.

You've just done a global column change. Now let's try a global format change. Begin by pressing ; to move the cursor to the bottom window. Type **IGF\$** You now have dollars and cents displayed in the bottom window and integers in the upper.

Press ; to jump the cursor into the top window and type **>B1** ® to highlight our original sales figure. At B1, type the number **300** ® and watch the changes ripple through all the columns as VisiCalc recalculates all the formulas. Now type the number **600** ® What happens?

Columns H through M show > symbols in some positions instead of numbers. The calculated results are too large to display in integer form in the narrow columns of the top window, or with two decimal places in the bottom window. You can press ; and type **IGFI** to see the final sales figure at M1 in the bottom window. It should be 1712.

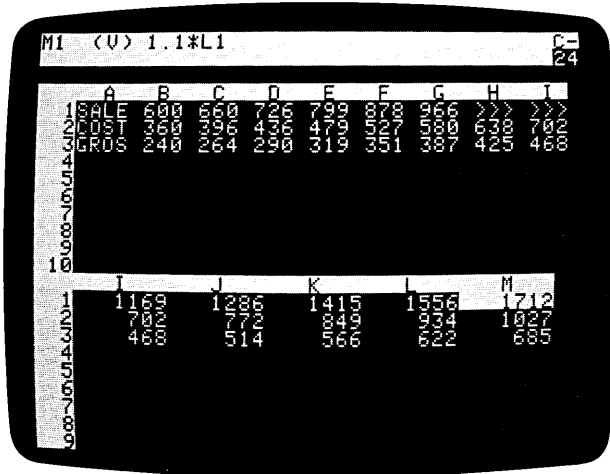

Summary

You have covered a lot of ground in this lesson. We encourage you to review any points you might have had difficulty with and to try your own experiments. The more you work with the VisiCalc program, observing and analyzing the results, the more quickly you will master it for your own work. Just remember the following key points:

- 1) No matter what you type at the keyboard, you cannot hurt either the computer or the VisiCalc program. Moreover, it's fairly difficult to destroy your own work on the electronic worksheet, particularly if you watch the prompt line for keystroke-by-keystroke feedback and save the worksheet periodically on diskette.
- 2) Throughout this lesson, we have introduced only four new commands. They are:
The **REPLICATE** command */R* that reproduces similar formulas in adjacent rows and columns.
The **GLOBAL** command */G* that changes the column width (*/GC*) and the way numbers are formatted (*/GF*).
The **TITLES** command */T* that fixes rows or columns of alphabetic titles in place, as part of the top or left hand "border".
The **WINDOW** command */W* that splits the screen, either horizontally or vertically, into two independently scrollable, formattable windows.
- 3) Aside from the Replicate command, which basically saves you time as you write formulas, all of the commands discussed in this lesson affect only the *appearance* of your work on the screen (generally in an effort to compensate for a small screen size). Nothing you might do with the */G*, */T*, or */W* commands can affect the labels, numbers or formulas actually written on the worksheet. When in doubt, you can always type */W1 /TN /GFG /GC9 ®* to return everything to normal.

Much of the power of the VisiCalc program is due to the simple and highly consistent way in which these commands interact with one another. In almost any context, a command will do what you would logically expect.

Armed with these assurances, you should be ready to *experiment*. Clear the screen and try out these commands with a problem of your own. If you don't understand something, go back through this lesson to see what you might have missed. Also check Part III, the VisiCalc Command Reference and the VisiCalc Reference Card for more complete explanations. Once you understand the fundamentals of this lesson, you'll know enough about the VisiCalc program to begin using it effectively.

Postscript: Memory and the Electronic Sheet

As you may know, your computer contains two kinds of fast semiconductor memory: RAM and ROM. ROM or “Read Only Memory” is manufactured with a fixed pattern of data or program instructions stored in it. RAM or “Random Access Memory” is made in such a way that it retains data that is put into it only as long as the memory’s electric power is left on or until new data is put into the memory in place of the old data. Data or program instructions are put into RAM memory either by typing at the keyboard or by loading prerecorded programs or data from cassette or diskette.

The VisiCalc program is loaded into RAM memory from diskette, and it, together with some RAM that the computer itself requires, takes up about 29K bytes. The remainder of RAM memory is devoted to the VisiCalc electronic worksheet. The VisiCalc program manages this area of memory automatically. You never have to concern yourself with the details of how the electronic worksheet is maintained. But you will find it useful to have a general idea of how the worksheet works as you begin using the VisiCalc program to its fullest capacity.

Essentially, the VisiCalc program reconfigures the electronic worksheet *dynamically*. That is, the VisiCalc program expands the size and shape of the worksheet as you use it. You actually start with a 1 by 1 worksheet, starting and ending at position A1. Although you can move the cursor to any position up to BK254, no memory is actually allocated for the worksheet until you write something on it.

Then the worksheet grows into a rectangle just large enough to include the rightmost and bottommost positions in which something is written. If you type a long message or formula at a particular entry position, the VisiCalc program will reserve additional bytes of memory for the position, but all of the other positions on the worksheet will remain just large enough to hold the information which you have written in them. This is called “dynamic memory allocation.”

The VisiCalc program continually displays the amount of memory available to you through the **memory indicator**. The memory indicator is the two-digit number located in the right corner of the prompt line just below the letter C. This number is the amount of memory in kilobytes still available for additional entries on the worksheet. With 48K of memory, this number should be 19 (or close to it). The memory indicator will vary as you write information on the worksheet or use commands (such as replicate) to write information.

As you move further downwards and to the right, writing labels, numbers and formulas, more and more memory is used until the available memory is

exhausted. If you finally exhaust all of the available memory, the VisiCalc program will replace the memory indicator with the flashing letter M, and refuse to write anything more on the worksheet.

To sum up, the VisiCalc program manages memory efficiently and automatically. Because memory is dynamically allocated and the worksheet is reconfigured to suit your needs, you can work ahead of yourself in terms of memory. Note, however, that if you have a relatively small amount of memory, you certainly shouldn't be wasteful with it. Aside from noticing from time to time how much space is still available for you to write in more entry positions, you need not concern yourself with problems of memory management.

Shrinking the Sheet

One thing the VisiCalc program does not do automatically, however, is to "shrink" the worksheet. Suppose that you have written on various portions of the worksheet, causing it to grow to a size of 100 by 100 positions. Later, having finished with this information, you might have erased or blanked out the entry positions near the right and bottom edges of the 100 by 100 worksheet.

However, the worksheet will remain configured as 100 by 100, with each empty position requiring 2 bytes. If you begin using additional memory by writing lengthy labels and formulas in other positions, you may want to shrink the worksheet to the smallest possible configuration for the information still written on it.

To do this, you must save the worksheet on diskette with the **/SS** command (as discussed in Lesson One), clear the worksheet with **/CY** and reload the saved worksheet with the **/SL** command (as discussed in Lesson Two). As the disk file is loaded, the VisiCalc program will enter on the worksheet only those labels, numbers and formulas actually saved, and in the process the worksheet will grow from a 1 by 1 configuration to just the size you need for the information remaining. This will make more memory space available for additional labels and formulas.

Lesson Three

In Lessons One and Two, we used several examples to illustrate both the simplicity and the power inherent in the VisiCalc program's concepts and features. In Lesson Three we will expand on the use of previously learned commands, bringing them into more powerful combinations.

To present these new combinations and to introduce new commands, we will set up a household budget as our example. We will supplement this example with suggestions on how you can adapt it to your personal use. Continue to work carefully through the examples and experiment to deepen your understanding. Your skill in using the VisiCalc program will grow proportionally with the amount of practice you have with it.

Let's begin with a clean slate. Load the VisiCalc program into your computer as described in Part I, the section entitled "Loading the VisiCalc Program," or, if you already have the program running, clear the worksheet by typing *JCY*

To prepare a budget, we'll first project our income for the next twelve months. We'll also project various necessary expenses such as food, rent or mortgage, telephone, etc. as well as semiannual expenses such as car insurance. Then we'll use the VisiCalc program to find out how much of our income is left for leisure and for savings and what percentage of our income is going for each category of expense. Finally we'll consider various enhancements such as calculating the interest on our savings account.

Setting Up for the Budget Sheet

Let's begin by laying out twelve months or periods across the worksheet. Make sure your direction indicator shows —. With the cursor at A1, type the word **PERIOD** to label row 1 and press the **→** key to move on to position B1. At this point, we have three choices as to how to number the twelve periods.

First, you could just type in the numbers 1 through 12 from B1 through M1. Second, you could type in a few numbers and replicate the rest, using the cursor to point to the extra coordinate positions. Third, you could type in the beginning number (1) at B1 and replicate that number with a relative formula that would add 1 to each previous number.

For speed in setting up the worksheet, let's use the third method. After all, we know from our earlier example that a label at A1 with twelve periods (months, years, etc.) following will extend to M1. If we weren't sure how many columns we would have to use, the second choice would be preferred.

With the cursor at B1, type 1 (our starting numeral) and press **→**. Let's put our initial "counting formula" at C1. A counting formula should add one to each previous number, right? So, type **1+B1 @** at C1. The prompt line should read C1 (V) 1+B1 and coordinate C1, highlighted by the cursor, displays the result of that formula as the number 2.

Now let's replicate this formula from D1 to M1. Type **/R** Ⓜ The prompt line reads REPLICATE: TARGET RANGE. The edit line reads

C1 . . . C1:

followed by the edit cue. Type **D1.M1** (D1 is our starting position; the period is our coordinate delimiter; and M1 is the final coordinate). The edit line should read

C1 . . . C1: D1 . . . M1

Now press Ⓜ The prompt line reads REPLICATE: N=NO CHANGE, R=RELATIVE. The edit line reads

C1: D1 . . . M1: 1 + B1

with a edit cue on B1 as in the photo below.

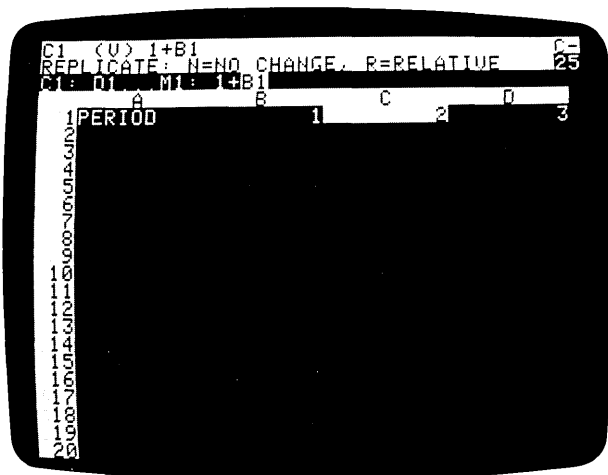

Press **R** to make the coordinate relative. This will give us 1 + C1, 1 + D1, etc. If you chose N, the absolute use of the formula would give you 1 + B2 — the numeral 2 — in every position from D1 through M1. The prompt and edit lines should go blank. Move the cursor out to column M to check your work. Position M1 should show the number 12.

Replicating Numbers and Labels

To start filling in our budget worksheet, type the following characters. Your direction indicator should still read -. End each entry with the Ⓜ key as shown:

> **A2** Ⓜ

INCOME Ⓜ **1800** Ⓜ

We'll assume that \$1800 is your monthly "take-home pay" after taxes and other deductions. Now let's fill in the figure 1800 for all twelve months. Press **/R** Ⓜ Can you replicate a single number as well as a formula?

Of course. A number is actually the simplest case of a formula. For the target range, type **C2.M2** Ⓜ. The VisiCalc program doesn't ask whether the new formula is relative or not, because the "formula," 1800, has no coordinates. The number 1800 should now appear in all twelve columns, in positions B2 through M2.

Next we'll draw a line across the worksheet. Move the cursor with **>A3** Ⓜ and then type **/-**. The prompt line reads LABEL: REPEATING, and the edit cue appears on the edit line. Whatever character or characters we type next will be repeated to fill the entry position A3.

Type **-** Ⓜ. You should now have a line of nine hyphens at A3. Is this any different from typing the hyphens manually? Type **/GC12** Ⓜ. As you can see, the Repeating Label expands to fill the widened entry position. Go back to normal column width by typing **/GC9** Ⓜ.

How can we easily extend the line across all twelve columns? The ever-useful replicate command will also replicate labels. Type **/R** Ⓜ. For the target range, type **B3.M3** Ⓜ. It's that simple. You should now have a line of hyphens extending all the way to column M.

Using Formulas for Flexibility

Before we go any further, let's think about what we've done. To save ourselves the trouble of typing the number 1800 twelve times, we replicated this number. That's fine as far as it goes, but is it the best way to handle our income? It would be better if we could change the income figure for all twelve months by just typing a new figure for the first month and taking advantage of the VisiCalc program's recalculation feature. Let's replicate a formula instead of a number. Type

```
>C2 Ⓜ  
+ B2 Ⓜ
```

We have defined the second month's income to be the same as the income for the first month. Let's replicate this income figure. Type **/R** Ⓜ and give the target range as **D2.M2** Ⓜ. The prompt line reads REPLICATE: N=NO CHANGE, R=RELATIVE.

Do we want the same formula, **+ B2**, in all of the remaining positions, or would we prefer **+ B2, + C2, + D2**, etc.? Either way we can change the income for all twelve months simply by typing a new number at B2.

Think further. What if we should get a raise in the sixth month? If every formula read **" + B2"** (the NO CHANGE case) you could change any month besides period 1 by typing in the new income figure. However, the VisiCalc program wouldn't replicate this change to later months, because all figures are based on B2.

If, on the other hand, each formula refers to the previous month (the RELATIVE case), we can simply type a new number in month 6 and "propagate" the change through months 7-12. Let's try it. Type **R** to make

the coordinate B2 relative. When the Replicate command has finished, use the **↓** key to move to month 6 (position G2). Now type **2000** **Ⓡ** to change income at month 6 to \$2,000.00.

Press **↓** a few more times to verify that each succeeding month's income has changed to 2000. Were you able to foresee the way in which the change would be propagated? Note that G2 now contains a number (2000) instead of the formula **+F2**. H2 is **+G2**. Naturally, it will copy anything in G2. Likewise, I2 reads **+H2**, so what was in H2 (2000) will be replicated into I2, and so on through M2.

If you weren't sure, move the cursor over all twelve income figures and imagine what would have happened if all of the formulas were **+B2**. If you feel adventurous, go back to where you began replicating this example (with the cursor on C2) and choose the **NO CHANGE** option to see what happens.

Entering **N** and studying the results provides an excellent lesson in the contrast between **RELATIVE** and **NO CHANGE**. If you do this, be sure to perform the exercise once again so that the entry positions are **RELATIVE** and 2000 is at coordinate G2.

Our next task is to list our expense categories and estimate monthly amounts for each category. Some expenses will vary from month to month, and other expenses will occur perhaps only every six months. We will leave these blank for the moment.

To enter these categories, press **(S)** to set the direction indicator to **!** Now you can use **↓** to move the cursor downward. We'll enter all the labels first and then the values for each label. This is a much quicker way to write lists of labels and values than writing each label and its respective value before going on to the next label and value. Go ahead and type in the following entries. Remember, you can use the Edit command if you make mistakes.

```

> A4 Ⓡ
MORTGAGE ↓
UTILITIES ↓
TELEPHONE ↓
FOOD ↓
CLOTHING ↓
CAR EXPENSE ↓
CAR INSURANCE ↓
SAVINGS ↓
> B4 Ⓡ 600 ↓ ↓
75 ↓
350 ↓
100 ↓
80 ↓ ↓
150 Ⓡ > C2 Ⓡ

```

At this point your screen should look like the screen photo below.

	A	B	C	D
1	PERIOD	1	2	3
2	INCOME	1800	1800	1800
3	MORTGAGE	600		
4	UTILITIES	75		
5	TELEPHONE	350		
6	FOOD	100		
7	CLOTHING	80		
8	CAR EXPEN	150		
9	CAR INSUR			
10	SAVINGS			
11				
12				

Next we would like to replicate the monthly expense figures in column B across for the remaining eleven months. Remember our discussion of the merits of replicating a number versus a formula for our monthly income?

To give ourselves maximum flexibility, we should also replicate relative formulas for the monthly expenses. At C4 we want the formula +B4; at C6 we want the formula +B6; at C7 we want +B7; and so on. We'll fill in figures for UTILITIES and CAR INSURANCE later.

These formulas are so similar to each other and to the income formula +B2 that it's tempting to look for a shortcut way of typing them. Once again, the Replicate command comes to our aid. This time, we'll replicate a formula down a column instead of across a row.

Replicating Down a Column

Make sure that the cursor is at C2 and the direction indicator is a !. The entry line reads

C2 (V) +B2

Just as we copied B2 to C2, we will want to copy B4 to C4, B5 to C5, and so on. Therefore, we want to treat the coordinate B2 as *relative*. Type **!R** ®. The prompt line reads REPLICATE: TARGET RANGE and the edit line reads

C2 . . . C2:

followed by the edit cue. Press the **↓** key twice to point down two rows to the first coordinate in the target range. Now the edit line reads

C2 . . . C2: C4

Type a period. The cursor jumps back to C2, and the edit line acknowledges that the target range will start at C4. Next press the **↓** key nine times (or

hold it down and press **REPT**) to point to position C11 (opposite the figure for SAVINGS). The edit line now reads

C2 . . . C2: C4 . . . C11

This means that the formula at C2 will be replicated across the target range of C4 through C11. Press **®** The cursor jumps back to C2, and the prompt line reads REPLICATE: N = NO CHANGE, R = RELATIVE. The edit line reads

C2: C4 . . . C11: + B2

with the edit cue over the coordinate B2. We want this coordinate to be relative. Press **R** A column of numbers, from 600 to 150, appears in column C.

Use **↓** (and **REPT**, if you wish) to move the cursor downward, pausing to look at the formulas we've replicated. We have what we wanted: at C4 is + B4, at C6 is + B6, and so on. We also have formulas at C5 and C10, but we can easily eliminate them. You can use either the **↓** or the **↑** (depending on your present position) and **/B ®** to do this, or you can use the GO TO command. Set the direction indicator to the horizontal mode – and type the following

```
> C5 ®
/B ↓
> C10 ®
/B ↓
> C4 ®
```

Replicating a Column Several Times

We now have the formulas we want for each expense category. The next step is to replicate these formulas across the rows through month 12. Think back to Lesson Two. Do you remember how we replicated a source range of formulas across the rows for both COST of goods sold and GROSS profit? We can do the same thing here.

Press **/R** and the prompt line will read REPLICATE: SOURCE RANGE OR RETURN. The edit line shows C4 followed by the edit cue. This time our SOURCE RANGE will be an actual range from C4 through C11. Now press **(S)** to set the direction indicator to ! and point to each coordinate in that range by pressing the **↓** key seven times to move the cursor down to C11. When you reach C11, the edit line should read

C4 . . . C11

followed by the edit cue. Now press **®** The cursor jumps back to C4, and the prompt line asks for a TARGET RANGE. Type **D4.M4 ®** as your reply.

We have asked the VisiCalc program to replicate the formula at C4 into positions D4 through M4, the formula at C5 into positions D5 through M5, the formula at C6 into positions D6 through M6, and so on through the formula at C11. Notice that we gave only the first coordinate in each column in the target range.

The prompt line reads REPLICATE: N = NO CHANGE, R = RELATIVE. The edit line shows

C4: D4 . . . M4: + B4

with the edit cue highlighting B4. This is the formula for the first expense, MORTGAGE. As was the case for B2 (INCOME), B4 should be relative. Watch the screen as you press R. Several things happen:

- 1) The cursor disappears (don't worry);
- 2) The number 600 appears at position D4;
- 3) The edit line now reads C6: D6 . . . M6: + B6

The VisiCalc program has finished replicating the formulas + B4, + C4, + D4, etc. in row 4, and has also replicated the blank entry at B5 into C5, D5, E5, etc.

In replicating a source range, the VisiCalc program lets you consider each item in the range individually. Should each formula be interpreted as a NO CHANGE or RELATIVE formula? Therefore, the VisiCalc program asks you how to handle the formula + B6 on row 6.

All of these formulas will be relative too. Press R five more times. With relatively few keystrokes, you have written a total of 80 numbers and formulas on the electronic worksheet with the aid of the Replicate command.

Think about the technique we used to replicate the expense formulas. Starting with the prototype formula + B2 at position C2, we created six more prototype formulas by replicating down a column: + B4 at C4, + B6 at C6, etc. Then we used these formulas as our source range to replicate similar formulas across on rows 4 through 11.

Each of the resulting monthly expenses can be changed for all twelve months simply by typing a new number for the first month. For example, type >B8 ® and change the number there by entering 120 ®. Your CLOTHING budget is raised to \$120 for all twelve months.

To complete our projection of expenses, we'll fill in figures for those expenses which cannot be replicated across because they vary from month to month. Our UTILITIES bill will vary depending on the season and the need for heating or air conditioning. Our CAR INSURANCE premiums are due every six months. We'll pay a premium in month 1 and month 7. With the direction indicator set to -, type the following exactly as shown.

```
> B5 ®  
140 ♣ 140 ♣ 80 ♣ 80 ♣ 40 ♣ 40 ♣ 85 ♣  
85 ♣ 50 ♣ 50 ♣ 100 ♣ 140 ♣  
> B10 ®  
160 ♣  
> H10 ®  
160 ♣
```

We do not have to fill in zeros for the other ten months in the row for CAR INSURANCE, because the VisiCalc program treats any blank entry as equivalent to zero. In fact, any entry containing an alphabetic label will have a “value” of zero if it is referenced elsewhere in a formula.

Now is a good time to save your work on diskette. Make sure that your Disk II's IN USE Light is off, then remove your VisiCalc program diskette and replace it in the pocket on the inside front cover of this manual.

Now insert an initialized storage diskette into drive 1 (or whatever drive you have selected as the default drive). Make sure the label side is up and that the oval cutout enters the drive first. Close the drive door and type `/SS` then `LSTHREE1.VC` ® Once the file is saved, the prompt and edit lines will go blank.

You should also make a backup copy of this file. Remove the diskette on which you just saved `LSTHREE1.VC` and insert a second initialized diskette. You might label it “BACKUP 1” and use it only for the purpose of saving backup files. Close the drive door and once again type `/SS LSTHREE1.VC` ®

If you should decide to end this session at this point, be sure you have removed the diskette(s) from the drive(s) and put them safely away before you turn off your Apple.

Fixing Titles in Both Directions

Again, we have a situation in which the descriptive titles (INCOME, MORTGAGE, etc.) will disappear from view if we scroll the window horizontally to look at later months. To solve this problem, we'll create a border of titles along both the left and top edges of the worksheet. These titles will stay in place no matter where we scroll.

Move the cursor with `>A3` ® and type the title command, `/T` The prompt line reads

TITLES: H V B N

Press **B** to fix titles in *both* directions.

The position of the cursor has a dual significance for this command. If you type `/TV` to fix titles vertically, the VisiCalc program will fix in place the *column* in which the cursor rests and all columns currently on the screen to the left of the cursor. If you type `/TH` to fix titles horizontally, the VisiCalc program will fix in place the *row* in which the cursor rests and all rows currently on the screen above the cursor.

Typing `/TB` is equivalent to typing both `/TV` and `/TH`, so the exact position of the cursor is important. The meanings of the keystrokes **H**, **V**, **B**, and **N** are described in Part II, Lesson Two and in the Part III, TITLES Command.

In this case, we have created a border consisting of column A along the left edge of the screen window, and another border consisting of rows 1, 2 and 3 along the top edge of the window. To check this, set the direction indicator to ! and hold down the \blacktriangledown and REPT keys to scroll the window downward past row 21.

Row 1, 2 and 3 remain in place. Now type > B4 $\text{\textcircled{S}}$ Press \blacktriangledown and REPT to see how the window scrolls horizontally, leaving column A in place.

Since all other numbers are the same from column to column, only the PERIOD and INCOME figures in rows 1 and 2 will change. Continue scrolling until columns A, M, N, and O are in the window. We'll use columns N and O to obtain totals and percentages for our income and expenses.

The Built-in Function @SUM

Set the direction indicator to ! and type the following

```
>N1  $\text{\textcircled{R}}$   
TOTAL  $\blacktriangledown$ 
```

The cursor should be at N2. How can we find our total income for twelve months? You could always type

```
+ B2 + C2 + D2 + E2 + F2 + G2 + H2 + I2 + J2 + K2 + L2 + M2
```

but there's a simpler way. Watch the prompt line and press @ As soon as you type the @ symbol, the prompt line says VALUE. Now type SUM(and the edit line reads @SUM(followed by the edit cue.

Now to indicate what numbers we want to sum. Set the direction indicator to - and hold down \blacktriangledown and REPT until you bump into the left border. The cursor should be at B2, and the edit line should read @SUM(B2 followed by the edit cue.

Press . and the cursor jumps back to N2 where we started. The edit line now reads

```
@SUM(B2 . . .
```

We are specifying a range of entries, just as we did with the Replicate command. To finish this range, press \blacktriangledown) $\text{\textcircled{R}}$ The entry line now reads

```
N2 (V) @SUM(B2 . . . M2)
```

The cursor highlights our total income for the year, 23000.

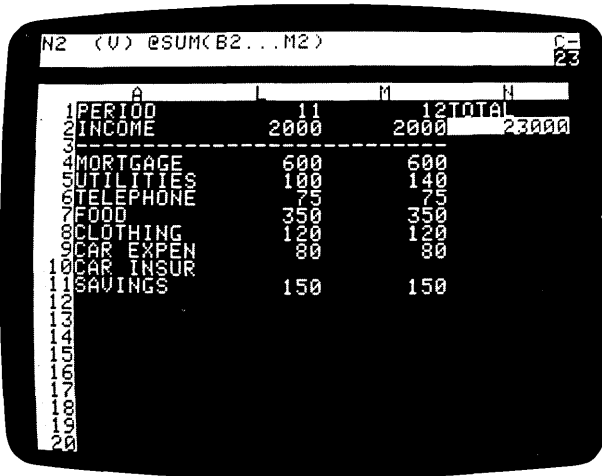

Let's consider the @ symbol in a little more detail. The @ symbol begins the name of a VisiCalc built-in function. When the VisiCalc program saw the @ symbol at N2, it immediately knew two things:

- 1) The entry was going to be a numeric VALUE;
- 2) The next few letters you typed would be the name of a built-in function.

Each built-in function, such as @SUM, performs some sort of calculation on the list of values given to it and yields a numeric result. Other examples of built-in functions are @MIN, @MAX, and @AVERAGE. See the Reference Card and the VALUE ENTRY Command in Part III for a complete description of all the functions.

The built-in functions (such as @SUM) will operate over

- 1) A range such as @SUM(B2 . . . M2);
- 2) A list of particular values such as @SUM(B2, B7, C3,D8);
- 3) A list of ranges, values, numbers or formulas, like @SUM(B2 . . . B7, C3 . . . C6, 25, D8, 4*C8).

You can use any numeric result of a built-in functions just as you would an ordinary number. For example, you could place it in another function or formula.

Let's get back to our example and obtain totals for each of the expense categories in our budget. We'll use replication again just as we did for INCOME.

With the cursor on N2 (our prototype formula), press /R Ⓜ To enter the target range, type N4.N11 Ⓜ The prompt line displays REPLICATE: N = NO CHANGE, R = RELATIVE and the edit line reads

N2: N4 . . . N11: @SUM(B2

with the edit cue highlighting B2.

Consider what will happen if we make B2 . . . M2 relative. Since we are replicating down a column, the replicated formulas will be in positions N4, N5, N6, etc. We want N4 to be the sum of B4 . . . M4, N5 to be the sum of B5 . . . M5 and so on. That is what will happen if the replicated formulas are relative. Press **R** twice. In an instant, the expense totals, from 7200 to 1800, appear in column N.

Note that if you wish to insert new material into an @SUM range, the formula will expand to include the new numbers. In doing this, you must obey two rules.

- 1) Never place the insertion at the same coordinates as the first item in the range.
- 2) Never place the insertion at the same coordinates as the @SUM formula. Both of these entry positions are out of range for the formula and will not be incorporated into the formula.

The VisiCalc program also lets you find out what percentage of your income each expense total takes. Set the direction indicator to ! and type in

>O1 Ⓢ
PERCENT ⚡ ⚡ ⚡

To find MORTGAGE as a percentage of INCOME you would divide your total mortgage payments by your total income, right? The VisiCalc program already has those totals — MORTGAGE at N4 and INCOME at N2. Therefore, to find the percentage, all you need to do is divide N4 (MORTGAGE) by N2 (INCOME). With the VisiCalc program, you don't have to use the dollar values, just the coordinates. Type + **N4/N2** Ⓢ The result is .3130435 or approximately 31%.

Formatting a Single Entry

The VisiCalc program's general format always displays numbers to the maximum number of significant digits permitted by current column width, unless we ask for a different display format. For our purposes, two decimal places should be enough. The global format command **/GF\$** (from Lesson Two) allows you to display everything to two decimal places.

Type **/GF\$** Our mortgage percentage at position O4 now appears as 0.31. Note, too, that all other numbers are also displayed in dollars and cents form. Even the month number 12 at M1 appears as 12.00. Not quite what we want. Change the global format back to "general" by typing **/GFG**

What we really want is to display just the number at O4 in dollars and cents form. With the cursor still at O4, type **/F\$** That's it! By leaving out the global part of the command, we formatted just the single entry. **/F\$** affects only the entry highlighted by the cursor.

Now that the percentage 0.31 is set, look at the label TOTAL at the top of column N. It's hard to read because it's too close to the number 12 in column M, and it doesn't line up with the numbers below it.

Move the cursor to the label TOTAL with >N1 Ⓜ The VisiCalc *general* format, which currently applies *globally* to all entries, starts all labels at the left end of their entry position and lines up numbers with their last digits on the rightmost positions of their respective columns. To change the format of TOTAL, type /F The prompt line reads

FORMAT: D G I L R \$ *

The possible keystrokes are:

- D** The format **Defaults** to the same values as the global format. There is no special format for this entry.
- G** Use the **General** format for this entry. You can use this, for example, to display a particular number with several decimal places even if the global format is I (for Integer).
- I** Display this entry in **Integer** format.
- L** Start this number at the **Left** side of the entry position.
- R** Make the last letter or digit of the entry line up at the **Right** end of the position.
- \$** Display this entry in **Dollars and Cents** format.
- *** Display this entry in **Graph** format, which uses asterisks to build bar graphs.

For examples, see Part II, Lesson Four; Part III, The FORMAT Command; and the Reference Card.

For TOTAL, type R Now TOTAL is lined up with the column of figures below it. Press (S) ↵ to move the cursor to O1 and type /FR to "right-justify" the label PERCENT. Your screen should now look like the one below.

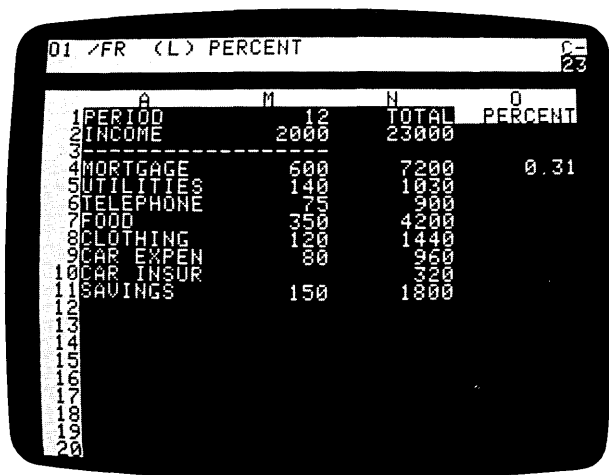

Replicating a Format Specification

Now that you have a formula for describing an expense as a percentage of INCOME (+ N4/N2), you can replicate it down column O rather than having to enter an individual formula for each expense category. Type >O4 Ⓜ to move to the formula for MORTGAGE expense as a percentage of INCOME. Type /R Ⓜ and enter O5.O11 Ⓜ as the target range. The edit line should read

```
O4: O5 . . . O11: + N4
```

with the + N4 highlighted. The prompt line reads

```
REPLICATE: N= NO CHANGE, R= RELATIVE.
```

How should we handle the formula + N4/N2, which is MORTGAGE as a percentage of INCOME? For UTILITIES at O5, we want + N5/N2. The first coordinate changes, but the second, N2 or INCOME, does not. Press R to make N4 relative.

Then, with the edit cue over N2 on the edit line, press N to indicate "No Change." The VisiCalc program allows you to choose which parts of a replicated formula will be relative and which will be absolute.

It takes the VisiCalc program only a moment to display all our expense percentages, from 0.31 for MORTGAGE to 0.08 for SAVINGS. Notice that all of the percentages are displayed to two decimal places.

Set the direction indicator to ! and press ⏏ a few times, looking at the entry line. At O5, for instance, the line reads

```
O5 /F$ (V) + N5/N2
```

The format specification /F\$ has been replicated along with the formula. In fact, it's possible to replicate a format specification even if the entry being replicated is blank! We'll use this trick a little later.

Using Replicate to Copy a Row or Column

Type >A12 Ⓜ We'll draw a line under our list of expenses and calculate how much money we have left for LEISURE. You already know one relatively easy way to draw a line of hyphens, by using the /- command at A12 and replicating the hyphens across. But let's try using the replicate command a little differently.

Type /R The prompt line reads REPLICATE: SOURCE RANGE OR RETURN, and on the edit line is the cursor coordinate, A12, followed by the edit cue. Now press ESC. The A12 disappears, leaving only the edit cue on the edit line. Let's type a new source range: A3.M3 Ⓜ As usual, the prompt line reads REPLICATE: TARGET RANGE. Type A12.A12

What are we doing? The source range, A3 . . . M3, is the line of hyphens already written on the worksheet. We're asking the VisiCalc program to replicate the entry at A3 into position A12, the entry at B3 into position B12,

and so on. Press **Ⓡ** There's your line. Incidentally, it would have been sufficient to type **A12 Ⓡ** for the TARGET RANGE; the VisiCalc program will take this to mean A12 . . . A12.

Finally, let's add LEISURE to our budget. The money we have available for leisure will simply be our income minus the sum of our expenses. Set the direction indicator to **-** and type the following

>A13 Ⓡ
LEISURE Ⓢ + B2 - @SUM(B4.B11) Ⓡ

The figure for LEISURE, 125, appears at B13. Replicate this formula across row 13 to get your LEISURE money for each period. Type **/R Ⓡ C13.M13 Ⓡ** and press **R** three times to make the formula coordinates relative. Press and hold down the **Ⓢ** and **REPT** keys to scroll the window to the right. Note the encouraging results the VisiCalc program has calculated for us.

Our LEISURE money starts small, at \$125 in the first month, but it increases fairly steadily thereafter. After the first month, we don't have a car insurance premium, and our utilities bill goes down in months 3, 4 and 5. In month 6, we get our raise, which increases our INCOME and LEISURE money.

Continue scrolling until you have brought columns M, N, and O into view, showing TOTAL and PERCENT, and then press **Ⓢ** to place the cursor at N13.

To obtain a total and percentage of income for LEISURE, we can use the same method we used earlier to copy the line of hyphens. To allow you to type in formulas in the same form as they take on the edit line, the VisiCalc program lets you substitute a colon : Watch the edit and prompt lines as you type in the following data.

/R ESC N11.O11:N13 Ⓡ RRRN

You should have a total of 5150 and a percentage of 0.22 for LEISURE.

Changing Windows and Titles

As we found in Lesson Two, the screen is too small to display both our starting expense figures in month 1 and our calculated totals and percentages in columns N and O. We can solve this problem by splitting the screen into two windows.

With the cursor still at N13, type /WV Your screen should look like the photo below. The titles in column A and row 1-3 are fixed in place in both windows.

M13 (U) +M2-@SUM(M4...M11)

PERIOD	M	PERIOD	O
INCOME	2000	INCOME	
FOOD	350	FOOD	0.175
CLOTHING	100	CLOTHING	0.05
CAR EXPE	0	CAR EXPE	0.00
CAR INSU	0	CAR INSU	0.00
SAVINGS	150	SAVINGS	0.075
LEISURE	485	LEISURE	0.2425

Press ; to jump the cursor over to the right window, bringing columns A and N into view. Then press /TN to eliminate the fixed titles from the window in which the cursor rests. The title or "border" column A disappears, exposing column M. Finally, press ↓ once to bring the TOTAL and PERCENT columns N and O into view.

Notice that columns are slightly narrower in this window. The VisiCalc program automatically adjusted the column widths to make room for the extra vertical border of row numbers that runs down the center of the screen.

Now press ; to jump the cursor back to the left window. Press and hold down ⏏ and REPT to scroll this window back to the first month (column B). Notice that you bump into column A. The fixed titles are still in effect in this window. Your screen should look like the screen photo below.

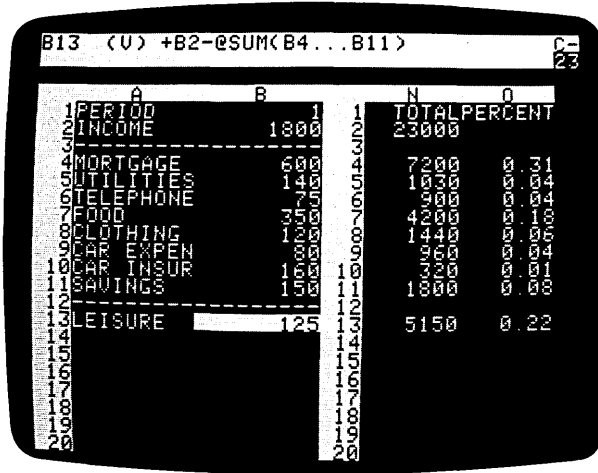

Let's try changing one of our expenses to see how the VisiCalc program recalculates the expense totals and income percentages. Type >B9 Ⓜ 100 Ⓜ What happens? Your available LEISURE money decreases by \$20 each month. The CAR EXPENSE total goes from \$960 (4% of your income) to \$1200 (5% of income). And your LEISURE total for the year goes from \$5150 (22% of income) to \$4910 (21% of income).

The @NA and @ERROR Functions

Press (S) \blacktriangledown to move to position B10. Let's suppose that you were about to change your car insurance policy, and the new premium was not yet known. The VisiCalc program has a special function to help you deal with just such problems: the @NA function (NA stands for "Not Available"). Watch the screen as you replace the number 160 at B10 by typing @NA $\text{\textcircled{R}}$

When you write this function at an entry position, that entry takes on the special value NA. When the VisiCalc program recalculates, any formula which refers to an entry containing NA will itself have a value of NA.

In this case, your car insurance premium for month 1 at B10 became Not Available. Because of this, you had no way to calculate your leisure money (income minus the sum of expenses) for month 1. As a result, position B13 (for LEISURE) became Not Available.

Moreover, your total car insurance expense for the year could not be calculated and also became NA, which meant that the corresponding percentage of income became NA. And, since one month's LEISURE expense was NA, the total was NA, and so was LEISURE as a percentage of income. Change B10 back by typing 160 $\text{\textcircled{R}}$ and all of the calculated values will be restored.

Here's a related issue. Suppose that, instead of typing a number, you were trying to calculate your own car insurance premium as the insurance company does, but you made a mistake and tried to divide by zero.

With the cursor still at B10, type 1/0 $\text{\textcircled{R}}$ As the screen shows, when the VisiCalc program evaluates the formula 1/0, the result is the special value ERROR. Like NA, the value ERROR "propagates." Any formula which refers to an entry with the value ERROR will itself have the value ERROR.

The most common ways to obtain a value of ERROR include dividing by zero, taking the logarithm of a negative number, and calculating a value too large for the computer to represent. ERROR can also be generated as a syntax error from an expression. If you save a worksheet with forward or circular references, you will find ERROR messages when you reload. To restore values to the ERROR positions, press ! to force a recalculation. Forward and circular references will be explained more fully later.

You can also deliberately obtain the value ERROR, just as you did for @NA, by typing the function name @ERROR. In fact, it can be used as a variant of @NA or as a debugging tool when working with lookup tables. For now, change the value at B10 back by typing 160 $\text{\textcircled{R}}$ so that the totals and percentages can be calculated.

To make sure that we can continue from this point if something goes wrong, let's save the worksheet on diskette again. The diskette that you used earlier in this lesson should still be in your disk drive. Type /SS and, in response to the prompt FILE FOR SAVING, press the \blacktriangledown key.

The disk drive should whirl, and a file name should appear on the edit line. Continue pressing the **↵** key, if necessary, until you have the name LSTHREE1.VC on the edit line. Then press the **ESC** key four times until the edit cue is sitting where the 1 was. Now type **2.VC** ® and watch the edit line as you type the characters.

You are saving the worksheet under the revised name LSTHREE2.VC. As you can see, all it takes is a few keystrokes to protect yourself from loss of time and data.

Now type **;** to jump the cursor into the right window and **/W1**. This leaves the narrowed columns on the screen. If you had typed **/W1** with the cursor in the left hand window, the screen would now have fixed titles and columns nine characters wide. Why? Because **/W1** gets its global settings for column, format, and title from the window in which the cursor rests at the time you issue the **/W1** command.

For now, type **/GC9** ® and **>A7** ® to adjust the column widths and scroll the screen back to the left edge of the worksheet. The cursor should highlight the label FOOD.

The Insert and Delete Commands

Let's say you decide to take on a life insurance policy that has monthly premiums of \$115, and you want to incorporate this expense into your budget. If you were working out this budget on an ordinary sheet of paper, you'd have to erase something or write in tiny letters off to the side. But the VisiCalc electronic worksheet is more flexible. The VisiCalc program allows you to insert rows and columns.

Watch the screen as you type **/IR** for "Insert Row". The VisiCalc program opens a blank line at row 7 by pushing the rows that were at or below the cursor position downward. We'll use row 7 to enter life insurance figures.

Let's look more closely at what the Insert command has done, using SAVINGS as our example. Has moving SAVINGS from B11 to B12 invalidated our formula for LEISURE (income minus the sum of expenses) — **+ B2 - @SUM(B4 . . . B11) ?**

To find out, take another look at the LEISURE formula at B14. Type **>B14** ® and look at the entry line. The VisiCalc program has extended the formula to read

+ B2 - @SUM(B4 . . . B12)

Whenever you insert, delete, or move a row or column, the VisiCalc program automatically adjusts all of the formulas on the worksheet. This way, your formulas always refer to the same entry positions as before even though the coordinates have changed. Never place the insertion on the first coordinate of the range. For example, if you specify a range of B5 through B10, you cannot insert a row of new material at B5. You can insert at any other position in the range and the formula will expand to include the new material.

Make sure the direction indicator is set to – then type in the following entries for life insurance expenses. We will begin by typing in the basic amount, making a formula based on it, and then replicating that formula across row 7. Finally, we will create and replicate a life insurance formula for the TOTAL and PERCENT columns.

```
>A7 Ⓜ
LIFE INS Ⓜ 115 Ⓜ + Ⓜ Ⓜ
/R Ⓜ D7.M7:R
>N6 Ⓜ
/R Ⓜ :N7:RRRN
>A10 Ⓜ
```

Notice that our LEISURE money has decreased by the amount of the life insurance premiums each month. Position B14 is now – 10, meaning that we're overspending our income in month 1. Perhaps we should ride the bus to work to eliminate most of our CAR EXPENSE.

Type >B10 Ⓜ and then press /D The prompt line reads DELETE: R C. With the cursor at B10, you could delete row 10 by pressing R, or column B by pressing C. Press R to delete row 10.

The title and figures for CAR EXPENSE disappear completely from the screen. The rows below the cursor move up one row to fill in the gap and are renumbered accordingly. CAR INSURANCE is now at row 10, and SAVINGS is back at row 11. Note that your LEISURE money at position B13 has increased back to \$90. If you check the formula at B13, you'll find that the VisiCalc program has readjusted it to

```
+ B2 - @SUM(B4 . . . B11).
```

You can also insert columns. Say that you want to obtain six month totals for your income and expenses. Type >H4 Ⓜ The formula there is + G4, and because of relative replication the formula at I4 is + H4. Now press /IC A new, blank column appears in place of column H.

Notice that the Insert command always inserts a row or column before the cursor's position ("before" meaning "closer to row 1 or column A than") and moves everything else to the right or down.

Press Ⓜ to bring the old column H (now relettered column I) into view. The formula at I4 is + G4, meaning that the propagation of the income and expense amounts skips over the newly created blank column.

Press Ⓜ twice more, and notice that the next formulas are + I4 and + J4. Now move back with >H4 Ⓜ and type /DC

Now that the blank column has been deleted, all of the other columns to the right have moved back to eliminate the empty space. Everything has returned to normal. If you've made any mistakes in this section, you can clear the screen, reload the diskette file named LSTHREE2.VC, and try each step again.

To test your understanding of the Insert and Replicate commands, try inserting the names of the months (such as JAN, FEB, MAR, etc.) just below the month numbers 1 through 12.

Have you succeeded? Here's one way to do it (with the direction indicator set to -). Type the following

```
>A2 ®
/IRMONTH ♦ /FR/R:C2.M2: (This replicates the format /FR.)
JAN ♦ FEB ♦ MAR ♦ APR ♦ MAY ♦ JUN ♦ JUL ♦ AUG
SEP ♦ OCT ♦ NOV ♦ DEC ®
>A2 ®
```

Calculating Interest on a Savings Account

According to our present budget, we are setting aside \$150 each month for savings. Part of the motivation for doing this is that we would like to earn interest on this money. Let's use the VisiCalc program to project the interest and the accumulated balance we would have if we put this money into a savings or other investment account.

We'll assume that interest on a savings account is paid at the rate of 5% per year, compounded monthly. For flexibility, we'll write this interest rate into a separate position on the worksheet, so that we can change it later and let the VisiCalc program recalculate the interest and accumulated balance. Make sure the direction indicator reads - and type

```
>A15 ®
SAV ACCT ♦
.05 ®
```

On the first day of each month, our account will be credited with interest for the balance in the account during the previous month, and then we'll deposit our monthly \$150. Type the following

```
>A17 ®
/FS$100 ♦
>A16 ®
INTEREST ♦
```

The \$100 at A17 is the previous balance in the savings account before our budget begins. The interest paid for one month will be one twelfth of the yearly rate (.05 divided by 12) times this previous balance. Type

```
/FS + B15/12 * A17 ®
```

The calculated result of this formula should be 0.42, shown at B16. Does this figure make sense? A year's simple interest at 5% on \$100 would be \$5.00. One twelfth of this would be \$5.00/12, or \$0.41666 (which rounds to \$0.42).

Press (S) to set the direction indicator to ! then press \blacktriangleleft to move to B17. Our new savings account balance will be the previous month's balance, plus the interest, plus the savings deposit for this month. Type

/F\$ + A17 + \blacktriangleleft + B12 $\text{\textcircled{R}}$

If you like, you can point with the cursor to fill in all three coordinates in this formula. The result is \$250.42.

To replicate both the interest and account balance formulas across for twelve months, type

> B16 $\text{\textcircled{R}}$

/R \blacktriangleleft :C16.M16:NRRRR

As you type the N and R's to determine whether each coordinate should be unchanged or relative, think about what each one means. The interest rate at B15 is constant from month to month. Thus it would be N. The R for A17 means "make this value *relative* to the value of the entry one position down and to the left of each copy of the formula."

Press (S) \blacktriangleleft to examine the calculated results. The interest paid each month increases. Why? Because monthly deposits and accumulated interest are added into the balance on which the interest is calculated. Continue scrolling the window to the right until column N comes into view, and then type

> N17 $\text{\textcircled{R}}$

/F\$ + M17 + N14 $\text{\textcircled{R}}$

This is the combined total of our savings and leisure money, our "discretionary income." It should currently be 6676.94. Compare your screen with the photo below.

	K	L	M	N
	10	11	12	TOTAL
	OCT	NOV	DEC	
	2000	2000	2000	23000
	-----	-----	-----	-----
	600	600	600	7200
	1000	100	140	1030
	1000	75	75	900
	1100	115	115	1380
	1200	350	350	4200
	1200	120	120	1440
	-----	-----	-----	-----
	150	150	150	1800
	-----	-----	-----	-----
	540	490	450	4730
	-----	-----	-----	-----
	1632.65	1789.49	1946.94	6676.94

The Move Command

Type **>A11** Ⓜ and make sure that the direction indicator is set to **!**. The cursor should highlight the label **CAR INSURANCE**. Paying that insurance premium in month 1 is taking a big bite out of our available **LEISURE** money in month 1 (which is \$90, as opposed to \$250 in month 2). Perhaps we can pay the insurance premiums by taking money out of the savings account.

On an ordinary sheet of paper, more erasures and writing in the margins would be necessary. Not so on the VisiCalc electronic worksheet. Type **/M**. The prompt line reads

◆ MOVE: FROM . . . TO

The coordinate **A11** is on the edit line followed by the edit cue. Now press

◆ The cursor moves down to highlight **SAVINGS**, and the edit line reads

A11 . . . A12

Press the ◆ key four more times and notice that the edit line change from **A11 . . . A12** to **A11 . . . A16** much as it did for the **@SUM** function and the replicate command. The cursor highlights **INTEREST** at **A16**. Now watch the screen and press Ⓜ. The following things happen:

- 1) The entire row for **CAR INSURANCE** moves down from row 11 to row 15, reappearing just above **INTEREST**.
- 2) The rows for **SAVINGS**, **LEISURE** and **SAV ACCT** move up, taking up the space vacated by the old **CAR INSURANCE** row and making a new space just above **INTEREST** for the new **CAR INSURANCE** row.
- 3) The cursor returns to where it was when we started the **/M** command at **A11**, which is now **SAVINGS**.

Look at the figure for **LEISURE** in month 1. It has increased from 90 to 250. The car insurance premium has been taken out of the sum of expenses used to calculate **LEISURE**. The formula at **B13** reads

+ B3 - @SUM(B5 . . . B11)

Because **CAR INSURANCE** has been moved out of range (to row 15), it is currently unaccounted for. We must revise the formulas in row 17 to take the car insurance premium out of the savings account balance. Type **>B17** Ⓜ and look at the entry line. The formula reads

+ A17 + B16 + B11

meaning the previous account balance, plus a month's interest on that balance, plus this month's savings deposit. To this we must add "minus the car insurance premium (if any)." Type the following

+ A17 + B16 + B11 - ◆ ◆ Ⓜ
/R:C17.M17:RRRR

This will create a relative replication of the new account balance formulas + A17 + B16 + B11 - B15, + B17 + C16 + C11 - C15, etc. across the row.

Now type **>N17** Ⓜ to examine our total discretionary income. It has declined from 6676.94, before we took the insurance premiums out of savings, to 6666.10. We are now saving less and spending more on leisure.

We have also lost about \$10 interest on our savings account. Notice that our LEISURE total at N13 has increased from 4730 to 5050. Perhaps we should save a little more each month to replenish the funds taken out to pay the insurance premiums.

Type **>A11** Ⓜ ↘ to bring the titles back on the screen and highlight the initial SAVINGS figure at B11. Since the \$160 expense for CAR INSURANCE at B15 covers our premiums for six months, we should save one sixth of this amount each month, in addition to our usual savings deposit. Type **150 + (B15/6)** Ⓜ

The parentheses in the formula tell the VisiCalc program to calculate that portion of the formula first. See the VALUE Command in Part III for a discussion of *precedence*. Thanks to our earlier use of formulas, the VisiCalc program automatically propagates the adjusted SAVINGS figure across all twelve months while recalculating LEISURE and our new savings account balance.

This recalculation has made the screen display somewhat messy because the global format for numbers is still the standard or general format. We can clean up the display by typing **/GFI**

The interest and savings account figures still show dollars and cents, because each of these entries has the "local format" **/F\$**. Now type **>N17** Ⓜ to reexamine our total discretionary income. It has increased to 6673.53.

The result of saving about \$27 more each month is that we have reduced our LEISURE total back to 4730. At the same time, we have regained most of the interest we had lost before.

Before continuing, save your work by typing **/SS** and using ↘ as necessary to bring the file name LSTHREE2.VC onto the edit line. Then press **ESC** four times and type **3.VC** Ⓜ

Obtaining Monthly Expense Percentages

This lesson has led you through some fairly sophisticated command combinations. Here's a little project you can try on your own — a challenge to test your mastery of the Replicate command. Create monthly percentages for each of your expenses, from MORTGAGE through SAVINGS. It's possible to accomplish this by typing just one formula and using the Replicate command twice.

Here are some hints. Use the area of the worksheet directly below your list of monthly expenses. Remember that you can replicate format specifications. If you want to get fancy, you can label each row of percentages with one more use of the Replicate command.

If you've succeeded, congratulations. You can probably do anything you want with the VisiCalc program from now on. Whether you've succeeded or not, let's make sure that your budget matches the one in this lesson.

Clear the worksheet by typing /CY Reload the file you just saved with /SL Press ↵ until the file name LSTHREE3.VC appears and then press Ⓜ Now set the direction indicator to – and type the following

- > A20 Ⓜ
- /R ESC A5.A11:A20:
- ↵ /F\$+ B5/B3 Ⓜ
- /R:B21.B26:RN
- /R.B26: ↵ .M20:RRRRRRRRRRRRRR (Type R fourteen times.)
- > A26 Ⓜ

Compare your screen with the photo below.

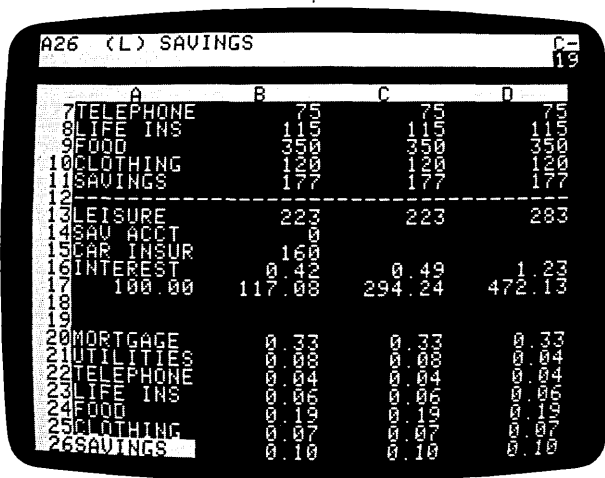

The first replication in this sequence illustrates another use of the Replicate command. You can copy a range of entries into another part of the same column (or to any other area on the worksheet) simply by specifying the destination starting coordinate for the target range. Check row 21 for UTILITIES to verify that the percentages may change from month to month.

Synchronized Scrolling

As you can see, the area of the worksheet that we have used extends beyond the screen window in both the horizontal and vertical directions. As you scroll the screen downward, the month labels, INCOME, and the first few expenses have disappeared from view. Let's split the screen so that we can see both the expense amounts and the percentages at the same time.

Set the direction indicator to ! and use ⬆ to move the cursor up to A19 just above MORTGAGE. Now type /WH The screen splits horizontally leaving just enough room for the expense percentages in the bottom window (we'll attend to those in a moment).

Type >A2 Ⓜ ⬆ ⬆ This should leave rows 2 (MONTH) through 13 (LEISURE) on display in the top window with the cursor at A4.

Next type /TB to fix the horizontal and vertical borders in place. Notice that the columns and rows forming the borders do not have to start from the edges of the worksheet. Finally, type ;>A26 Ⓜ to bring all of the expense percentages into view and /TV to fix the labels MORTGAGE through SAVINGS in place.

Now set the direction indicator to -. Press ⬆ while holding down REPT until the bottom window begins scrolling rightward. The problem is that we can't easily tell which months these expense percentages refer to. The month labels, such as JAN, FEB and MAR, are visible only in the top window, which isn't scrolling.

We'd really like the two windows to scroll together horizontally, but remain independent vertically so that we can view different areas of the worksheet through the two windows, as we are now (with row 2-13 in the top window and row 20-26 in the bottom). Type /W again and look at the prompt line. The possible keystrokes are

- H** To split the screen **Horizontally**.
- V** To split the screen **Vertically**.
- 1** To return to **One** screen window.
- S** To **Synchronize** the two windows.
- U** To **Unsynchronize** the windows.

Press **S** and watch what happens in the *top* window. Notice that this window scrolls over so that portions of the same columns are visible through the top and bottom windows. Now press ⬆ a few times. The two windows move together "in sync."

Type ; to jump the cursor into the top window, and then type >B7 Ⓜ Change the TELEPHONE expense to something else, say \$100 per month and watch the line of percentages opposite TELEPHONE in the bottom window. Notice that LEISURE in the top window also changes.

Now let's use the two windows for a different purpose. Type **/WU** to unsynchronize the windows. Move to the lower window with **;** and type

>A1 ® /TB>O17 ®

to bring your LEISURE total and percentage, your final savings account balance, and your combined discretionary income into view.

Continue by pressing **;** to jump back to B7 in the top window. Finally, change the TELEPHONE expense back to 75, watching how this effects the LEISURE percentage in the bottom window. You can also experiment with the budget in other ways. At this point, you may wish to save the results of this lesson by typing **/SSMYBUDGET.VC ®**

The screenshot shows a VisiCalc spreadsheet with two windows. The top window displays a monthly budget breakdown, and the bottom window displays a summary of totals and percentages.

2	A	B	C	D
3	MONTH	JAN	FEB	MAR
4	INCOME	1800	1800	1800
5	MORTGAGE	600	600	600
6	UTILITIES	140	140	140
7	TELEPHONE	75	75	75
8	LIFE INS	115	115	115
9	FOOD	350	350	350
10	CLOTHING	120	120	120
11	SAVINGS	177	177	177
12	LEISURE	223	223	223

1	A	M	N	O
2	PERIOD	12	TOTAL	PERCENT
3	LEISURE	423	4730	0.21
4	SAV ACCT		320	0.01
5	CAR INSUR			
6	INTEREST	7.33		
7		1943.53	6673.53	

The Order of Recalculation

So far, we've simply noticed that the VisiCalc program recalculates the values of all the formulas on the worksheet, but we haven't looked closely at how this is done. There are some subtleties to the process of recalculation that can affect your results when you set up a complex problem with many interdependencies. We'll consider these issues here.

The VisiCalc program recalculates by starting at the upper left hand corner of the worksheet and working its way downward and to the right until it reaches the lower right hand corner of the worksheet. Each formula is evaluated only **once**, unless you ask for an extra recalculation by pressing **!**

As a general rule, this means that formulas that reference other entries must be located below and/or to the right of these entries. For example, an entry at position A1 cannot be a formula that references other positions.

The VisiCalc program will evaluate the formulas on the worksheet in either of two possible orders: “down the columns” or “across the rows.” Look again at the letter C just to the left of the direction indicator in the upper right corner of the screen. This is the **recalculation order indicator**. It can be either **C** (for Column recalculation) or **R** (for Row recalculation).

When you load the VisiCalc program or clear the worksheet, the VisiCalc program is set to recalculate “columns first.” It will evaluate first A1, then A2, then A3, etc. followed by B1, B2, B3, etc., then C1, and so on. If you change the recalculation order to “rows first,” the VisiCalc program will evaluate first A1, then B1, then C1, etc., followed by A2, B2, C2, etc., then A3, and so on.

For many problems, the choice of row versus column first recalculation has no effect on the results displayed on the screen. But there are cases where you must use the right recalculation order to obtain correct results, and it's important to recognize these cases when they arise. Consider an example. Clear the worksheet with *ICY* and type

```
1 ⚡ - A2 Ⓜ
> A2 Ⓜ
1 + A1 ⚡ 2 * B1 Ⓜ
> C5 Ⓜ
+ A1 ⚡ 1 + C5 Ⓜ
> C6 Ⓜ
- D5 ⚡ 2 * C6 Ⓜ
> A1 Ⓜ
```

As you type the formulas, think about how each entry depends on the other entries. As you can probably see, the matrix of entries starting at A1 must be recalculated in the order A1, A2, B1, B2 (since B1 depends on A2). The matrix of entries at C5, however, must be recalculated in the order C5, D5, C6, D6 (since C6 depends on D5).

With the cursor at A1, type **2** Ⓜ and watch what happens. A2 becomes 3, B1 becomes -3, and B2 becomes -6, as expected. But while C5 becomes 2 and D5 becomes 3, C6 remains at -2, and D6 at -4.

The formula at D5 was recalculated, but this occurred *too late* to affect the recalculation of C6 and D6. Now press **!** to trigger an extra recalculation. This time C6 becomes -3 and D6 becomes -6.

Now we'll change the order of recalculation from “columns first” to “rows first.” Press **/G**. The prompt line again reads GLOBAL: C O R F. Press **O**. Now the prompt line reads REEVAL ORDER: R C

Press **R**. Notice that the recalculation order indicator at the upper right corner of the screen changes from C to R. Now type **1** Ⓜ and watch the screen.

This time, D5 becomes 2, C6 becomes -2, and D6 becomes -4. Note, however that while A2 becomes 2, B1 stays at -3, and B2 at -6. Our problem with B1 and B2 is similar to our earlier problem with C6 and D6.

The moral of this example is that you should lay out your calculations with recalculation either by column or by row, but not both. If possible, you should arrange things so that the results will be correct with *either* type of recalculation. Then, if you decide to calculate something new that requires a particular order of recalculation, you won't be constrained by other dependencies on the recalculation order.

For example, the personal budget outlined in Lesson Three is independent of the order of recalculation. Suppose that you want to adjust your life insurance policy and premiums to provide a benefit of three times your total annual income. You could do this by switching to "row first" recalculation, so that the life insurance premium in month 1 could be based on the total income calculated in column N.

If you find yourself with a problem of conflicting requirements for "row first" and "column first" recalculation, first make certain that your row and column conflict is not actually due to a "forward reference" or a "circular reference," as discussed below. If a reference problem isn't involved, you must force an extra recalculation by pressing ! each time you change a value.

Forward and Circular References

Clear the worksheet with /CY and type 1 \downarrow - \downarrow $\text{\textcircled{R}}$ The entry line reads B1 (V) - C1 and the value displayed at B1 is 0, as expected.

Now type \downarrow 1 + \downarrow \downarrow $\text{\textcircled{R}}$ The entry line reads C1 (V) 1 + A1, and the value at C1 is 2, while the value at B1 has been updated to -2.

Next type >B2 $\text{\textcircled{R}}$ - C1 $\text{\textcircled{R}}$ We now have the same formula, - C1, at both B1 and B2, and both positions display the value -2.

Is there any difference between these two formulas? Indeed there is. One of these formulas will recalculate and display the correct value only if the order of recalculation is "row first." The other will never display the correct value after an automatic recalculation.

To see this, type >A1 $\text{\textcircled{R}}$ 2 $\text{\textcircled{R}}$ and watch the screen. A1 becomes 2 and C1 becomes 3, but both B1 and B2 remain at -2. Press ! and both B1 and B2 will be updated to -3.

Type /GOR and note that the recalculation order indicator changes from C to R. Then type 3 $\text{\textcircled{R}}$ and watch the screen. A1 becomes 3, C1 becomes 4, and now B2 becomes -4, but B1 remains at -3. You'll have to press ! again before B1 will change to -4.

If you change A1 again, B1 will display a value based on the previous contents of C1 and A1. The formula at B1 is an example of a **forward reference**. It contains a reference to an entry that will be recalculated after B1 is recalculated, regardless of whether you use row or column recalculation.

In extremely difficult cases, forward references may refer to other forward references, so that correct results can be obtained only with several recalculations. If the cursor is not on A1, type **>A1** Now try this example. Press **↵ /IC - ↵ Ⓜ**

At the moment, A1 is 3, the new B1 is 4, C1 is -4, and D1 is 4. Press **↵ 1 Ⓜ** A1 becomes 1, D1 becomes 2, but B1 and C1 are unchanged. Press **!** Now C1 is -2, but B1 is still 4. Only after you press **!** again will B1 be updated to 2.

An even more startling effect is caused by a **circular reference**. The value of such a formula cannot be settled with any number of recalculations! Clear the worksheet with **/CY** and type **1+ ↵ Ⓜ** The entry line reads A1 (V) 1 + B1, and the value under the cursor is 1, as expected.

Now type **↵ 1+ ↵ Ⓜ** and watch carefully. What happened? The numbers at A1 and B1 actually changed *twice*. When the formula 1 + A1 was completed at B1, it was evaluated, yielding 1 + 1 or 2 at B1. Then, since the value of B1 had been changed, an automatic recalculation occurred. A1, or 1 + B1, became 1 + 2 or 3, and B1, or 1 + A1, became 1 + 3 or 4.

Now press **!** A1 increases to 5, and B1 becomes 6. These values will change every time you press **!**

The foregoing examples have been somewhat artificial. You probably recognized the forward and circular references as soon as you typed them. If you are planning your work carefully, you shouldn't write such a formula, unless you do it purposely as a debugging tool. Some forward or circular references are not so obvious.

For example, suppose that you are projecting future profits, taking into account various revenues and expenses. One of the expenses is employee salaries, and one part of salaries consists of profit-sharing. Unless you are careful, you may create a circular reference. Salaries with profit-sharing depend on profits, but profits depend on expenses including salaries. To resolve this circularity, you must calculate a figure for profits before profit-sharing is taken out.

Once you are aware of the issues involved in recalculation, it is not difficult to avoid conflicts in the order of recalculation or forward and circular references. Generally, these problems arise when you are working too quickly without a plan, or "patching" an existing layout on the electronic worksheet. If your approach to the problem is orderly and well thought out, it is unlikely that you will encounter any problems with recalculation.

Summary

Once again, we have covered a great deal of ground in this lesson. We concentrated on a variety of techniques for using the VisiCalc program's flexible replicate command as effectively as possible. We also discussed a number of new VisiCalc features — the formatting of individual numbers and labels; the relationship between global and local formats; the order in

which the VisiCalc program calculates and recalculates; built-in functions such as **@SUM** and the special cases **@NA** and **@ERROR**; the Insert, Delete, and Move commands that let you “stretch” the worksheet and manipulate entire rows or columns; and synchronized scrolling of the two screen windows.

We have covered most of the important concepts and features of the VisiCalc program, and you should be able to use the VisiCalc program to considerable advantage. In Lesson Four we will cover a number of other features and fine points of the VisiCalc program, including scientific notation for numbers as well as the transcendental functions such as **@EXP**, **@LN**, **@SIN**, and **@COS**. You will also learn more about the formatting of numbers and the Move command.

With the amount you have learned about the VisiCalc program, this is an excellent time to test your understanding on a problem of your own. In this way, you will consolidate your knowledge of the VisiCalc commands and features and develop your own ideas about how they can be used. This will enable you to approach new problems and solve them even more rapidly with the VisiCalc program.

Postscript: The Print Command

Sometimes it's convenient to have a “hard copy” of the contents of the electronic worksheet on a real sheet of paper. The VisiCalc Print command lets you print all or any part of the electronic worksheet on a printer. If you have a printer connected to your computer, you can try it out by printing a copy of the personal budget we've just created.

The instructions for printing files you have made with the VisiCalc program are in Part III, the PRINT Command. Note as well that using a **/SS** to a printer is a good debugging tool, particularly in uncovering circular references.

Lesson Four

If you have scientific or engineering applications in mind, you'll find Lesson Four particularly relevant to your needs. In this lesson, we'll concern ourselves primarily with features which extend the VisiCalc program's usefulness to applications requiring complex or lengthy formulas, numbers with very large or small magnitudes, or sophisticated arithmetic operations.

If you intend to use the VisiCalc program for business or financial applications, you can skim much of this material, while concentrating on the @NPV (Net Present Value) function, @LOOKUP functions, and /F* formatting option for creating bar graphs.

More on Numbers and Formats

In Lessons Two and Three we illustrated some of the ways you can control the display of numbers on the screen with formatting commands such as /GFI and /F\$. In this lesson we'll examine the formatting options more closely.

Load the VisiCalc program into your computer (as described in Part I under "Loading the VisiCalc Program") or, if you already have the program running, clear the worksheet with /CY. When you clear the worksheet, the "global format" is set to *general*.

This is the effect you obtain when you type the command /GFG. Each individual entry is set to *default* to the global format, just as it would if you had typed /FD with the cursor at that entry. With the direction indicator set to -, type the following

123.456 ®

/R: ♦ . ♦ ♦ :

We now have the same number, 123.456, on display in three entry positions, A1, B1 and C1. Since we have not yet set any explicit formats, all three entries default to the global format. The *general* global format displays numbers in whatever form will show the value of the entry with the greatest precision. As you have seen, however, this may not be the most readable way to display a column of numbers.

Now type /FI ♦ /F\$ ♦. We have set the "local format" of A1 to *integer* and B1 to *dollars and cents*. The entry line displays the local format setting for the coordinate where the cursor lies, A1. It reads A1 /FI (V) 123.456.

The VisiCalc program displays the locally formatted entries in rounded form. At A1, for example, 123.456 is rounded down to 123 because .456 is less than .5. At B1, however, 123.456 is rounded up to 123.46, since the last digit .006 is greater than .005. At C1 the general format is still in force, so we still have 123.456.

Now type /GFI to change the global format from *general* to *integer*. Entries A1 and B1 are unaffected because they have explicit local formats. C1,

however, displays 123 because it took its form from the general format at the time we changed to an integer format.

With the cursor still at A1, change the local format there by typing **/FG**. The number at A1 now appears as 123.456, and the entry line reads

A1 /FG (V) 123.456

The local format has overridden the global format integer.

Press **⬇** to move to B1 and “erase” the local format there by typing **/FD**. This causes the display format of B1 to default to the global format, which is currently *integer*. The entry at B1 now appears as 123. The entry line reads

B1 (V) 123.456

The explicit format setting **/F\$** has disappeared.

Finally, type **/GFG** to set the global format back to general. Now all three entries display the number 123.456. Position A1 has a local format that overrides the global setting, but the local format is also general. Positions B1 and C1 have no explicit format, so they default to the general format.

The way in which numbers are displayed in the general format depends on the column width. Type **/GC7**®. Now the number appears as 123.46 at all three entry positions. The VisiCalc program always allows for one blank at the left end of the entry position and then displays as many significant digits as it can.

To compare the flexibility of the general format to an explicit local format, try the following. If necessary, go to position B1 by typing **>B1**®. Type **/F\$** to set dollars and cents format at position B1. Then type **/GC6**

Positions A1 and C1 now display the number as 123.5, but B1 now shows **>>>>** (an effect that we saw before in Lesson Two). The VisiCalc program is telling us that it cannot display a number as large as 123.456 with two decimal places in a column six characters wide. Type **12.34**® and the VisiCalc program will display this number at B1.

Scientific Notation

Type **/CY** to clear the worksheet. At position A1, type eight nines (**99999999**) followed by **⬇**. This is the largest number that we can display with a leading blank in a nine-character column. Enter **1 + ⬇**®**⬇**

The calculated result, $1 + 99,999,999$ or $100,000,000$ is too large to display in ordinary form at B1. To handle this problem, the VisiCalc program has switched to **scientific notation**. The number $1E8$ equals “1 times 10 to the 8th power” or “1 followed by 8 zeros.”

The “E” stands for “exponent” because the hidden 10 takes a displayed exponent (in this case, 8). Scientific notation (also referred to as “exponential notation”) can also be used to display very small numbers.

At C1, type **.000000001** (that’s 8 zeros) followed by **⬇**. The number displayed, $1.E-9$, equals “1 times 10 to the -9 th power” or “1 with the decimal point moved left 9 places.” Count from the decimal point over nine places to the

right, and you'll see that this is correct. Now at D1 type \leftarrow \textcircled{R} The result is displayed as $-1.E-9$. In ordinary notation, this would read $-.000000001$ (as you will see in a moment).

When a number is displayed in the general format, the VisiCalc program will automatically shift between conventional and scientific notation as required to display the calculated value with the greatest precision. Type \textcircled{R} Notice that all of the values revert to conventional notation in the widened columns. At D1, for example, the number appears as $-.000000001$

Next type \textcircled{R} and \textcircled{R} The number 99999999 at A1 has been rounded up and displayed as $10.0E7$ or "9.9999999 (rounded to 10.0) times 10 to the 7th power." Finally, type \textcircled{R} and look at the screen.

In order to fit the numbers in these narrow column, the VisiCalc program has eliminated decimal points, displaying A1 as $10E7$ and C1 as $1E-9$ But D1 shows $>>>>$ since there's not enough room in a five-character column to display $-1E-9$ (with a leading blank).

More on Value References

The VisiCalc program allows you to fix the value of a value reference in a formula using # (typed by pressing **SHIFT** and **3** together). Clear the worksheet with \textcircled{Y} and type the following

1 \leftarrow **2** \leftarrow **+A1/B1** \textcircled{R}

The entry line reads C1 (V) + A1/B1 and the value displayed is .5. We know that if the number at either A1 or B1 were changed, the formula at C1 would be recalculated. Now press \leftarrow to move to D1. Here we'll try something different.

Watch the edit line as you type **+A1/B1#** As soon as you press the # after the coordinate B1, the reference to B1 is replaced by its current value of 2. The edit line now reads **+A1/2**. Press \textcircled{R} The entry line reads D1 (V) + A1/2 and the value displayed is again .5.

The difference is that the current value of B1 is "fixed" into the formula at D1, whereas the value of B1 is changeable at C1. To verify this, type \leftarrow \leftarrow **4** \textcircled{R} and notice that C1 changes to .25 but D1 does not.

The effect of # after a value reference on the edit line is similar to the effect of typing ! after a formula, as described in Lesson One. The difference is that the ! key evaluates the *entire formula* on the edit line, replacing it with a single number while the # key fixes the value of a *single coordinate*, so that the rest of the formula can contain changeable elements.

If the # is not preceded by a coordinate such as B1, it is replaced by the current value of the entry where the cursor lies, i.e., the entry you are changing. You can use this feature to take a look at the precise value of a formatted entry on the edit line.

For example, set the global format with \textcircled{R} and then type **6** \textcircled{R} The value at C1 is now displayed as .17. Press \leftarrow to move to C1, then press # The # is

immediately replaced on the edit line with the current value of C1 (1/6) to maximum precision: .166666666666

A word on precision is in order here. The VisiCalc program maintains numbers internally in decimal form. To accommodate large financial figures and high-precision engineering or scientific values, the VisiCalc program guarantees precision to eleven digits (and sometimes twelve digits) at base 10.

Certain fractions (such as 1/6) cannot be expressed exactly with any fixed number of significant digits. The twelfth digit (the last 6 in the expression above) is a "guard digit" that allows the VisiCalc program to determine which way to round the eleventh digit when a calculation is completed. After examining the number, you can type **CTRL C** (hold down **CTRL** while you press **C**) to cancel the value entry you have started on the edit line.

More on Formulas

In the examples from previous lessons, we have used only simple formulas (or *expressions*) whose meanings have been clear. As you begin to write more complex expressions involving several arithmetic operations, the way in which such expressions should be evaluated may not be so obvious.

For example, to evaluate the expression $9 + 6/3$, should we first add 9 to 6 giving 15 and then divide by 3 to obtain 5; or should we first divide 6 by 3 giving 2, and then add 9 to obtain 11?

Try it. First clear the screen and set the direction indicator to ! with **ICY(S)**. Now type **9 + 6/3** Ⓜ. The answer displayed at position A1 is 5. Evidently the VisiCalc program chose the first option. In this way, the VisiCalc program is similar to many keystroke calculators in that it always evaluates expressions strictly **from left to right**.

You can change the order of evaluation of arithmetic operations in an expression by using parentheses. Press **↓** to move down to A2 and then type **9 + (6/3)** Ⓜ. The answer at A2 is 11. Parentheses may be nested (placed within other sets of parentheses) up to nine times before producing an ERROR message.

With the direction indicator still set to !, type in **↓ - (↓ ↓ + ((A2 - 1)/A1))** Ⓜ. The answer displayed at A3 should be -7.

More generally, an expression consists of a series of **operands** separated by arithmetic **operators**. Each operand can be one of the following:

- 1) A number, optionally with a decimal point and/or an E exponent.
- 2) A value reference, obtained either with cursor movements or by typing the coordinate.
- 3) A function reference, with zero or more arguments in parentheses. An argument is any number that a function depends on for its value.

- 4) An expression surrounded by parentheses. Such a subexpression is evaluated first.
- 5) Any of the above, preceded by a $-$ or $+$ sign.

Each operator can be one of the following:

- + For **addition**.
- For **subtraction**.
- * For **multiplication**.
- / For **division**.
- ^ For **exponentiation**.

The caret character (^) is the exponentiation operator. The caret is located on the **N**. To use it, you must hold down the **SHIFT** key and type the **N** key. The exponentiation operator ^ lets you calculate "powers."

For example, with the direction indicator set to **!**, type **♦ 2 ^ 3 ®** to calculate "2 to the 3rd power," or 8.000000. Try another example; type **♦ 2 ^ .5 ®** to calculate "2 to the power 1/2," or the square root of 2. The result displayed at A5 should be 1.414214. To find the cube root of 5, type **♦ 5 ^ (1/3) ®**. The VisiCalc program will calculate and display the value 1.709976.

More on Built-in Functions

We first encountered built-in functions in Lesson Three, where we used the **@SUM** function to find yearly totals for our income and expenses and to calculate our available LEISURE money as **+ B2 - @SUM(B4.B11)**, or income minus the sum of expenses. As mentioned above, a function reference can appear in an expression wherever a number or coordinate could appear.

Moreover, as we shall see shortly, an expression may also occur as an argument in a function reference. We also saw that one type of function argument is a range of entries, such as **B4 . . . B11** in the LEISURE example. You need type only one period, the VisiCalc program will fill in the other two. And you will see shortly that the VisiCalc program will "spell out" the names of built-in functions if you type just the first few letters and a left parenthesis.

In general, a built-in function name is followed by a **list of arguments** enclosed in parentheses. The individual arguments are separated by commas. Each argument can be:

- 1) An **expression**, i.e., a series of numbers, value references, and/or function references separated by arithmetic operators and/or parentheses; or
- 2) A **range** of entries, i.e., a series of entries that are next to each other in a row or column, such as **B2, B3 and B4**, or **B2, C2, D2 and E2**. A range is specified by typing (or obtaining with cursor movements) the first and last entry separated by an ellipsis (3 dots in a row). For example, the ranges just mentioned would be specified as **B2 . . . B4** and **B2 . . . E2**, respectively.

The exact number and type of argument(s) required varies from function to function. For example, the **@NA** and **@ERROR** functions which we saw in Lesson Three required no arguments. Some functions require exactly one or two arguments, while others, such as **@SUM**, take a variable number of arguments.

Let's try an example of the **@SUM** function using the general form for a list of arguments. Notice that as soon as you type the left parenthesis, the VisiCalc program finishes spelling out the function name on the edit line. Make sure the direction indicator is still ! and use the **↵** key to move to position A7. Now type

@S(A1.A4,A5*A5,A6^3) ®

The result should be $5 + 11 - 7 + 8 + 2 + 5$ or 24.00000. Let's experiment further with some other built-in functions.

The **@MIN** and **@MAX** functions accept a list of arguments just like the **@SUM** function. The result is the MINimum and MAXimum value in the list, respectively. Remember that the minimum value will be the negative number (if any) with the greatest absolute magnitude. That is to say, -4 is a smaller number than -3. If you removed the their minus signs, 4 would be the number of greatest absolute magnitude.

Let's try out these functions. Watch what happens when you type in **@M** followed by a (The VisiCalc program adds IN. Similar "spell outs" occur with **@MA** and **@S** With the direction indicator showing !, go ahead and enter the following

↵ @M(A1.A7) ®

↵ @MA(A7,@S(A1,A2,A4.A6)) ®

The results should be -7 for **@MIN** at A8, and 27.12419 for **@MAX** at A9.

The **@COUNT** and **AVERAGE** functions also accept a list of arguments, which may be expressions or entry ranges. **@COUNT** determines the number of nonblank entries occurring in the ranges of the argument(s).

Note that arguments that are expressions rather than ranges always count as 1. This can be puzzling if the "expression" is a single coordinate such as B1. It will add 1 to the count *even if B1 is blank*. To avoid this, write **B1...B1**. By converting a blank B1 to a range, you exempt it from being counted by **@COUNT**.

@AVERAGE finds the arithmetic mean of the entries making up the argument(s); it is equivalent to **@SUM(arguments)/@COUNT(arguments)**. To try out these functions, clear the worksheet and reset the direction indicator with **/CY(S)** Then type the following

1 ↵ ↵ 3 ↵ 4 ↵ ↵ 6 ↵ ↵ 8 ↵ /— — ↵

The cursor should now be at A10.

Type **@C(A1.A8) ®** The count of nonblank entries displayed at A10 should be 5.

Now type **↵ @A(A1.A8) ®** The average of 1, 3, 4, 6, and 8 should be 4.4 at A11.

To check the equivalence mentioned above, type $\downarrow @S(A1.A8)/A10 \textcircled{R}$ The result should again be 4.4

Finally, let's change one of the currently blank entries in the argument range to a number. Type $>A5 \textcircled{R} 5 \textcircled{R}$ The **@COUNT** at A10 should change to 6 and the **@AVERAGE** at A11 and A12 increase to 4.5

The **@NPV (Net Present Value)** allows you to compare the value of a current sum of money with a future sum that has accrued interest. **@NPV** accepts two arguments. The first is a *single expression* specifying an annual discount rate (or interest rate, such as 15% (entered as .15).

The second argument is a *range of entries*. The first entry is the cash flow at the end of the first period. The second entry is the cash flow at the end of the second period and so on for all the periods under consideration.

The result of the function is the Net Present Value of the cash flows in the range, discounted at the rate specified by the first argument. If we represent the function reference (using *dr* to symbolize discount rate and *n* as the last number in a series of entries) by **@NPV(dr,entry1 . . . entryn)** and let $DR = 1 + dr$, the result of the function is

$$(entry1/DR) + (entry2/(DR^2)) + (entry3/(DR^3)) + \dots + (entryn/(DR^n)).$$

To see this function in action, begin by clearing the worksheet and making narrower columns with **/CY/GC6 \textcircled{R}** Suppose that we have a project that requires an initial investment or cash expenditure of \$5000, which is expected to generate cash over a period of five years. Type the following to lay out the cash flows.

```

 $\downarrow 1 \downarrow 1 + \downarrow \textcircled{R}$ 
/R:D1.F1:R
>A2 \textcircled{R}
- 5000  $\downarrow$  1000  $\downarrow$  1500  $\downarrow$  2500  $\downarrow$  2000  $\downarrow$  1000 \textcircled{R}
>A3: (S).15  $\downarrow$ 

```

At position A4, type $+A2 + @NPV(A3,B2.F2) \textcircled{R}$ This causes the \$1000 cash flow in the first year to be discounted by 15%, the \$1500 cash flow in the second year to be discounted twice, etc. The result at A4 should be 288.3

Now press \downarrow and change the discount rate to 10% by typing $.1 \textcircled{R}$ The net present value at the lower discount rate (which makes the future cash flows worth more today) is 1014.

You can find the internal rate of return of this project by trial and error. Try higher and lower discount rates at A3 until the net present value of the cash flows is near zero. When A3 is .17, A4 will be 34.81. If you are persistent, you can verify that the net present value is .0000005 when the discount rate is .1728674256.

The **@LOOKUP Function** accepts two arguments. The first or "search" argument is an expression. The second argument, an entry range, specifies the table where the first argument can be "looked up".

In performing a lookup, the VisiCalc program tries to match the search argument against one of the entries in the table specified by the range. Note: a table of function result values must be present in the column or row immediately to the right of or immediately below the column or row range specified in the **@LOOKUP** function.

The function result is taken from the entry corresponding to the matched entry in the table of result values. The values in the function argument range are ordinarily in ascending order. The search argument is compared against succeeding entries in the second argument range until an entry greater than the search argument is found. The search argument is then "matched" against the entry just before this one, i.e., one which is still less than or equal to the search argument. Finally, the function result is selected from the corresponding entry in the table of result values.

If the *first* entry in the argument range is greater than the search argument, i.e., if the search argument cannot be matched against any entry in the range, the result of the function is **NA** (Not Available).

To illustrate the use of this function, we'll list the first ten entries in the periodic table of the chemical elements, with their atomic weights and atomic numbers. Clear the worksheet with **/CY/GFL** and type the following

```

ELEMENT ♦ WEIGHT ♦ NUMBER ®
>A2:(S)
H ♦ HE ♦ LI ♦ BE ♦ B ♦ C ♦ N ♦ O ♦ F ♦ NE ®
>B2 ® 1 ♦ 4 ♦ 7 ♦ 9 ♦ 11 ♦ 12 ♦ 14 ♦ 16 ♦ 19 ♦ 20 ®
>C2 ®
1 ♦ 1+ ♦ ® /R:C4.C11:R
>A13:(S)
10.9 ♦ @L( ♦ ,B2.B11) ®

```

The result of the **@LOOKUP** function at B13 should be 4. Given an experimental atomic weight of 10.9, the **@LOOKUP** function compared this value against successive values in column B, stopping at the value 11 at B6 which was greater than 10.9. Thus, the atomic weight of 9 at B5 is the matching value, and the corresponding entry, the atomic number in column C, is 4.

If you change the value to be looked up with **♦ 12.1 ®** the function result will become 6. If you then enter an "atomic weight" of **0 ®** the result of the **@LOOKUP** function will be **NA**.

The **@ABS** and **@INT** functions both accept a single argument, an expression. **@ABS** finds the "absolute value" of its argument. For example, **@ABS(1)=1**, **@ABS(-1)=1**, and **@ABS(0)=0**. **@INT** finds the "integer portion" of its argument without rounding. You can think of the **@INT** function as setting every digit to the right of the decimal point to zero.

For example, type **/CY** to clear the screen, then enter **/FI1.7 ♦ @I(♦) ®** At A1, the value 1.7 is rounded up to 2 by the local format integer. At B1, however, **@INT** gives the "integer portion" of 1.7 as 1.0 or 1.

Transcendental Functions and Graphing

We'll illustrate the transcendental functions, such as @EXP, @LN, and @SIN, and the "graph" format /F* together in an example.

Our goal is to produce graphs of the transcendental functions. We'll have to do this within the limits of the /F* formatting option, which is really designed to draw simple bar graphs in a column alongside other columns of numbers.

Clear the worksheet and change the direction indicator to ! with /CY(S) Now type 1 ↵ 3 ↵ 6 ↵ 20 Ⓜ followed by >A1 Ⓜ

The "star" format /F* simply displays the number of asterisks equal to the *integer* portion of the value of the entry where the format is set. Type /F* at A1. In place of the (right-justified) number 1, a single (left-justified) asterisk appears, after the usual leading blank.

Now type ↵ /F* The value 3 is replaced by three asterisks. Continue with ↵ /F* ↵ /F* Position A3 shows six asterisks, while position A4 shows eight (the maximum for a nine-character column).

Type /GC12 Ⓜ and notice that position A4 now displays 11 asterisks. Now clear the worksheet again with /CY

To graph a function, we must first supply a series of argument values for the function and calculate the function result for each argument value. For simplicity's sake, we'll begin with a linear function, e.g. $f(x) = 2.5 * x$. Type the following

```
>A20 Ⓜ
.1 ↵ .1 Ⓜ
>A1:(S)
+ A20 ↵ + ↵ + B20 Ⓜ
/R: ↵ .A17:RN
```

On row 20, we have defined a "start" value and "step" value for our list of function arguments. Then, using formulas and the Replicate command, we calculated the argument values, from .1 to 1.7 in positions A1 to A17. Next we'll calculate the corresponding function results for our linear function. Type the following:

```
>B1 Ⓜ
2.5*A1 Ⓜ
/R: ↵ .B17:R
```

The function results are .25, .5, .75, etc., up to 4.25. To see how this looks in the star format, we'll set the format specification and replicate again.

Type /F*/R: ↵ .B17:R How does the "graph" look? It's probably not the kind of graph you had in mind. The problem is that the function results do not fall conveniently in the range 1, 2, 3, etc., which would yield one, two, or three asterisks.

Let's go back to a numeric display with /FD/R: ↵ .B17:R

How can we create a better star format display? First, we'll set up a wider column in which the asterisks may appear so that we can represent a wider

range of function results with the best possible resolution. This will allow us to display a "bar" of up to 17 asterisks. Then we'll "scale" the function results, form .25 to 4.25, into the range 0 to 17. Type the following

```
> B18 ®
/--- ♦ @MAX(B1.B17) ®
/|GC8 ®
>C1 ®
/|VV;/GC18 ®
17/B19* @ABS(B1) ®
```

At B19, we've used the @MAX function to find the upper limit on the range of function results. For simplicity's sake, we'll work with the absolute magnitudes of the function results, so the lower limit will be zero. You may wish to work out an approach to scaling which uses both @MAX and @MIN. We've also set up a wide column in the right hand screen window for the asterisks.

The formula at C1 is used to multiply each function result, such as B1, by the factor 17 (the maximum number of asterisks) divided by B19 (the maximum function result). The value of this formula will lie in the range from 0 to 17/B19*B19 or 17.

Now type /F* to set the display format at C1. Watch the screen as you type /R: ♦ .C17:NR

Your screen should look like the photo below, a reasonably approximated straight line. Moreover, if we've done our job properly, we should be able to graph any set of function results in column B, not just the linear function $f(x) = 2.5 * x$. We will want to adjust the argument range so that we can graph an interesting portion of the function result range.

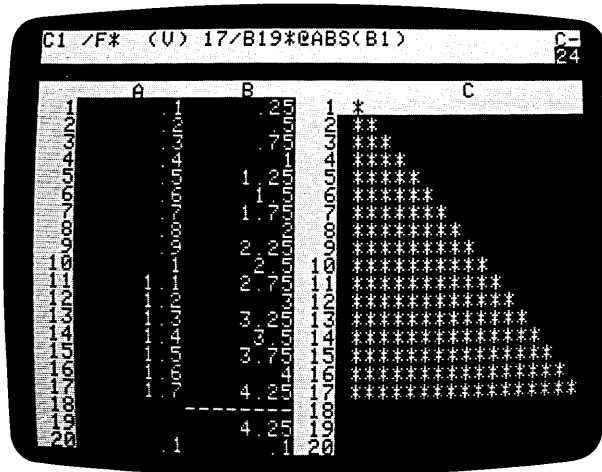

Now type the following

```
; > A20:(S)
1 ♦ .25 ®
> B1 ®
@ LN(A1) ®
/R: B2.B17:R
```

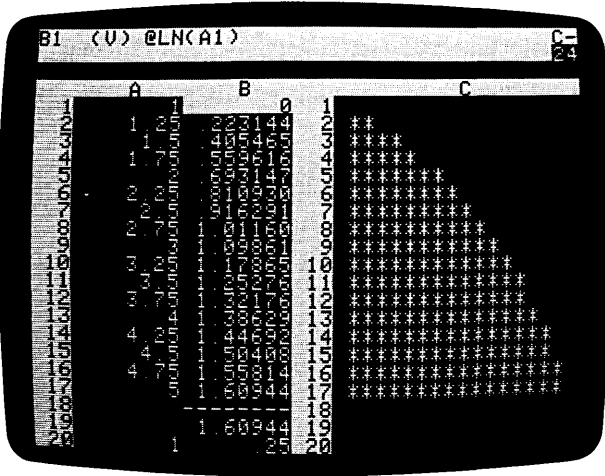

Notice that the value of @MAX(B1 . . . B17) at B19 changes to 1.60944. This value affects the formulas in column C so that the results still come out in the range 0 to 17. If the graph of the natural log function doesn't look completely familiar, tilt your head sideways and imagine the X axis on the column and the Y axis on the row.

Now let's try the exponential function. Type

```
@EXP(A1) ®
/R:B2.B17:R
```

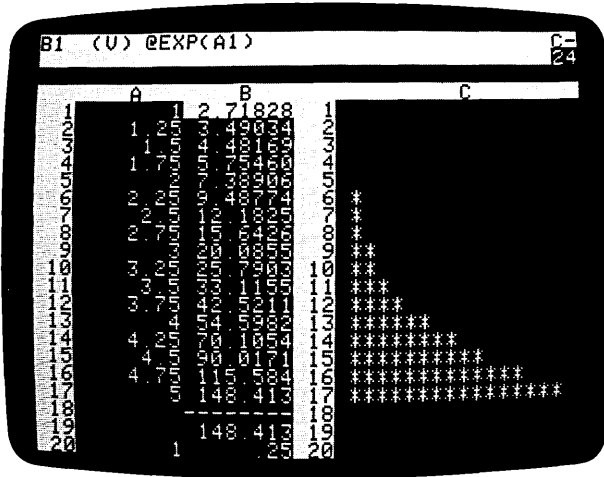

The maximum function result value is now 148.413, and each result is scaled into the range 0 to 17 in column C. Is the graph close to what you expected? Finally, we'll graph the sine function. Since the trigonometric calculations are done in radians, we'll use @SIN(@PI*A1) and a different argument range so that we can obtain a full sine curve in column C. Type the following

```
>A20 ®
.03 ↵ .06 ®
>B1 ®
@SIN(@PI*A1) ®
/R:B2.B17:R
```

If all has gone well, you'll have a reasonable graph of the sine function in column C, looking like the photo below.

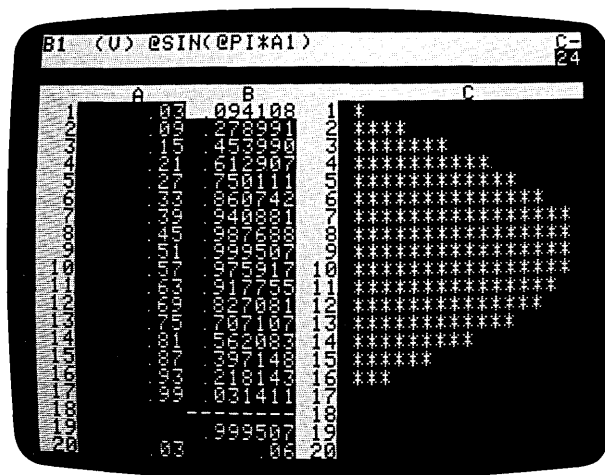

At this point, you may wish to experiment with different argument values and functions. There is further discussion of these and other built-in functions in Part III, the Value Entry Command. When you're finished, you can go on with the next section.

Manual and Automatic Recalculation

If you've just worked through the above example at your keyboard, graphing the transcendental functions, you've probably noticed some significant delays as the VisiCalc program repeatedly recalculated the results of functions such as @EXP, @LN, and @SIN.

Because the function results are calculated to eleven or twelve digit precision, each one takes a fraction of a second to evaluate, and a worksheet full of function references can take several seconds to recalculate. This problem gets worse as the amount of information on the electronic worksheet increases.

In many cases, you don't actually need to have all of the values recalculated every time you change an entry. It would be convenient if you could change several entries and then trigger a recalculation when you're ready to look at the results. The VisiCalc program lets you do this with the /GR command.

If you still have the graph of the sine function from the previous section on your screen, we'll try changing the argument range start and step sizes. If you no longer have this graph on the screen, you can just read along.

Type >A20 ® to move the cursor to the starting value, which is currently .03. When you load the VisiCalc program or when you clear the worksheet, you are in **automatic recalculation** mode. As soon as you change the value

at A20, the VisiCalc program will automatically recalculate the values of all the formulas on the worksheet.

Before doing this, however, type /G The prompt line reads GLOBAL: C O R F. Press R Now the prompt line reads RECALC: A M. The possible keystrokes are M to switch to Manual recalculation mode and A, to return to Automatic mode.

Type M You have "turned off" automatic recalculation. Now you can change the values at A20 and B20 without waiting for a lengthy intervening recalculation. Type .06 ↵ .12 Ⓜ We're ready for a recalculation — just press the exclamation key !

As you've probably noticed before, the C in the upper right corner of the screen flashes while the recalculation takes place. Whether you're in manual or automatic mode, pressing ! triggers a recalculation of all formulas on the screen (unless ! is pressed while you're entering a LABEL or VALUE on the edit line). Notice how the graph changes to display the positive-going portion and the reflection of the negative-going portion of the sine curve.

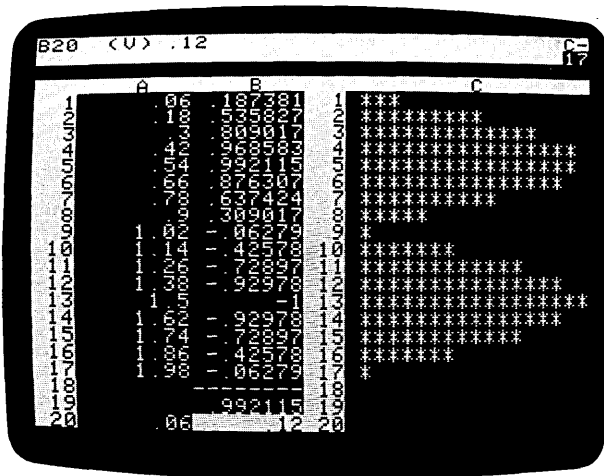

Now type .06 ↵ .54 Ⓜ Then return to automatic mode by typing /GRA The first thing that happens as you return to automatic mode is a recalculation to update all the figures on the screen.

Summary

This lesson has introduced you to the full power of the VisiCalc program's calculation capability. Besides simple addition, subtraction, multiplication and division, the VisiCalc program provides exponentiation, transcendental functions, and scientific notation.

You can use functions such as **@SUM**, **@MIN**, and **@MAX** to manipulate entire rows, columns, or other ranges of numbers. Functions like **@COUNT**, **@AVERAGE**, **@NPV**, and **@LOOKUP** allow you to quickly handle common problems such as test score averaging, evaluating the terms of a loan, or looking up figures in the income tax tables.

You can control the format of calculated results in a variety of ways — even creating simple graphs with the **F*** format. With practice, you'll be able to use the features described in this lesson in combination with the VisiCalc program's screen and window control and formula replication capabilities to solve complex problems quickly and easily.

Lesson Four concludes Part II, the VisiCalc Tutorial. The next section, Part III, is the VisiCalc Command Reference. The Reference section contains in-depth discussions of all the commands you've used in the Tutorial, including the fine points of the VisiCalc program illustrated with examples. Both are helpful in putting the VisiCalc program to work in your own applications.

As you use the VisiCalc program, you will discover countless techniques and application ideas that may be useful in your work.

After you've had a chance to read this manual and use the VisiCalc program for some of your own applications, we'd appreciate it if you would fill out and send in the Reader's Comment Form at the back. We're interested in corrections and suggestions for the manual, as well as suggestions for improvements in the VisiCalc program itself. In the meantime, we hope you find the VisiCalc program to be an enjoyable and useful tool.

Introduction to Part III, the Command Reference

Part III gives detailed summaries of all the VisiCalc commands as well as information on topics such as the VisiCalc screen, your keyboard, and file names.

The commands and topics are alphabetically organized. Command options are arranged in the order they appear on the prompt line of the VisiCalc screen. If you are not using the VisiCalc Tutorial, we recommend that you turn first to the section titled The VisiCalc Screen for general information about the VisiCalc program.

To help you find specific information, each command reference begins with a chart displaying all of that command's options. The charts for the individual commands are taken from the Command Structure Chart on the next page. This chart makes a very handy "roadmap" to maximum productivity with the VisiCalc program.

VISICALC COMMAND STRUCTURE STRUCTURE CHART

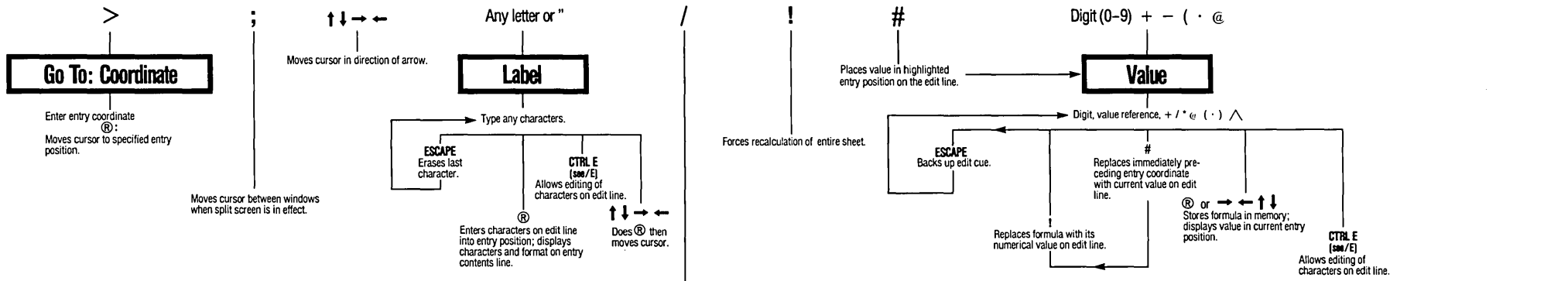

Command: B C D E F G I M P R S T V W -

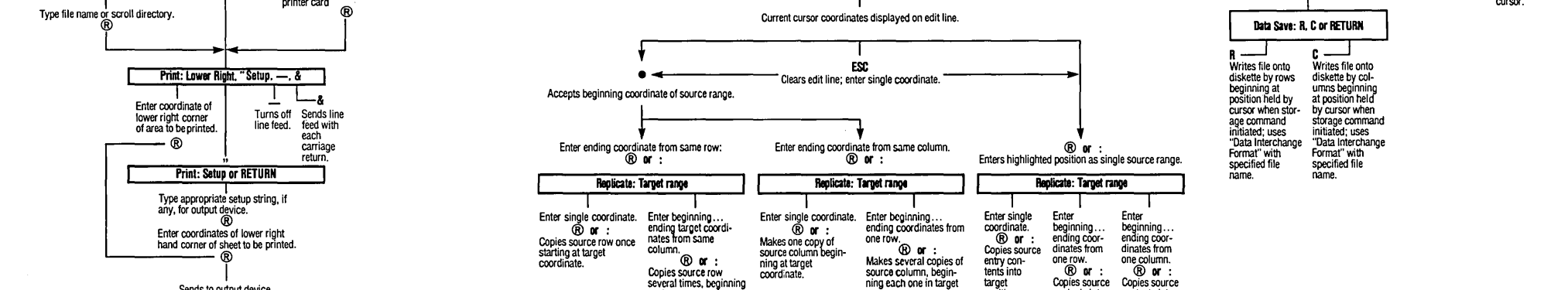
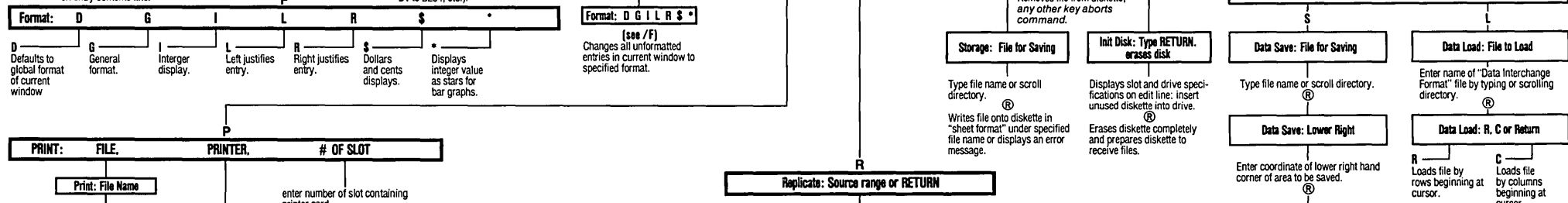
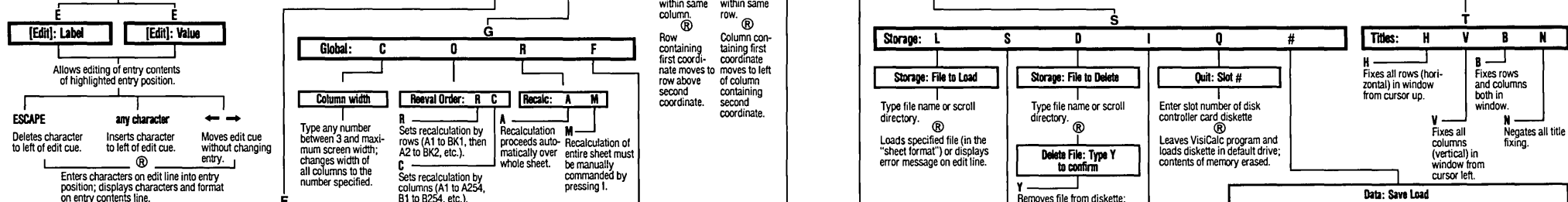
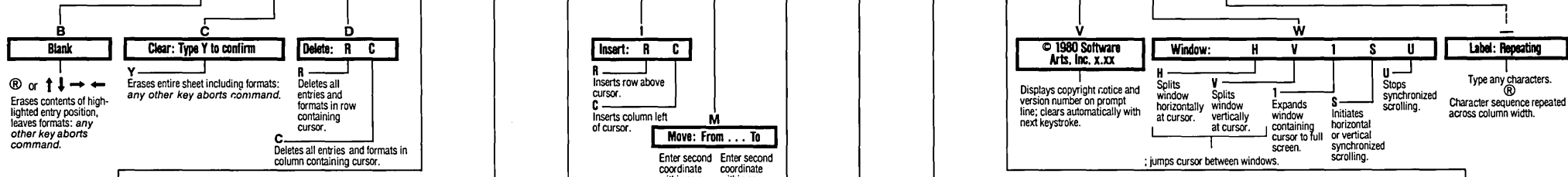

The Blank Command

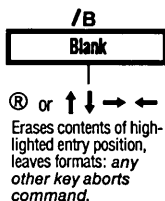

The Blank command erases the label or value at the entry position where the cursor rests without affecting the existing format setting for that position.

Example

- 1) Place the cursor on the entry position to be erased.
- 2) Type **I**
- 3) Type **B**
- 4) Press Ⓜ

prompt line: C O M M A N D :
 BCDEFGIMPRSTVW-

prompt line: BLANK

The status area will clear and the highlighted entry position will be blank.

Or press an arrow key

The status area will clear, the original entry position will be blank, and the cursor will be on the next entry position. Note that if you use an arrow key, the direction indicator must be set *before* initiating the **IB** command.

The Clear Command

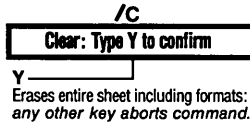

The Clear command **irretrievably erases** all information on the worksheet. Clear also performs the following functions.

- 1) Returns the cursor to coordinate A1;
- 2) Blanks all entry positions;
- 3) Resets the direction indicator to –
- 4) Resets all formats, titles, and windows to their initial specifications given when VisiCalc is first loaded.

If you want to save the information on the worksheet, be sure to do it (see Part III, the STORAGE Command) before issuing the Clear command.

Example

- | | |
|------------|---|
| 1) Type /C | prompt line: CLEAR: TYPE Y TO
CONFIRM |
| 2) Press Y | The screen will darken for a few seconds, then display the copyright and version notices. Your next keystroke will clear the prompt line. |

The DELETE Command

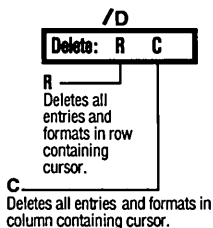

The Delete command **completely erases** all entries from the row or column in which the cursor rests at the time the command is issued. Once the VisiCalc program removes a row, it fills in the blank space by moving the rows below the deleted row upward. If a column is deleted, the columns to the right are moved over to fill in the gap. The cursor may rest anywhere in a given row or column at the time you execute the command.

The VisiCalc program also automatically looks up all value references in formulas and changes them to correspond to the new coordinates which result when rows or columns are moved after the Delete command. It then recalculates the whole worksheet. However, the value **ERROR** will appear at any position which refers to entries in the deleted row or column. The examples given below illustrate these points.

To use this command, first place the cursor in the row or column you want to delete. Then type **/D**. The prompt line reads **DELETE: R.C.** Type **R** to delete the row in which the cursor is located. Or type **C** to delete the column. The VisiCalc program immediately deletes the information and moves all other rows or columns accordingly.

Example

- 1) Type **/CY** To clear the worksheet. Cursor is at A1.
- 2) Type **1** ↓ **2**
 ↓ **3** ↓ **1 + C1**®
- 3) Type **>B1**® Your screen should look like this:

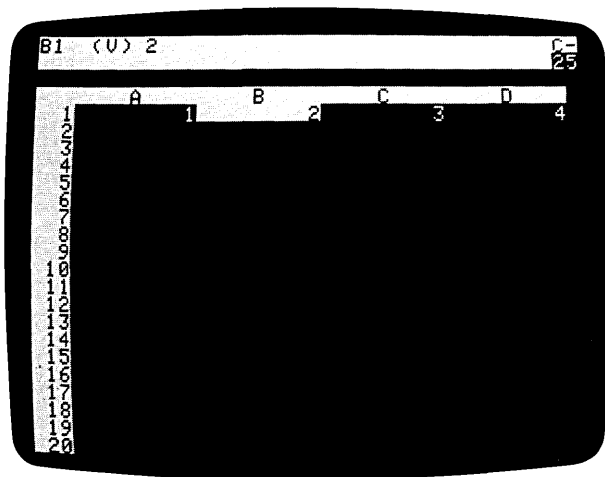

- 4) Type /D
- 5) Type C

prompt line: DELETE: R C
Your screen looks like this:

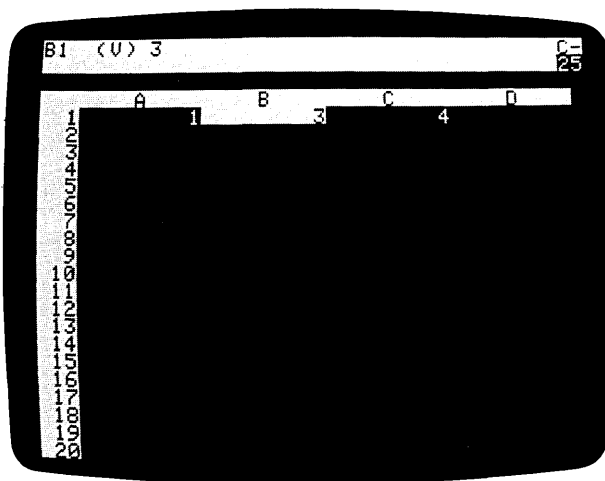

- 6) Press ↵

entry line: C1 (V) 1 + B1

Note that the formula has been changed from $1 + C1$ to $1 + B1$ so that it still refers to the value of 3 that you originally entered at C1 in step 2 of this example. When the entries in column B were deleted, the VisiCalc program moved all columns over and then changed the value reference so that the formula is correct relative to the new positions.

Use the Delete command with care. **You cannot recover the information from a row or column once you have deleted that row or column.** The Insert command (see Part III, the INSERT Command) can recreate the row or column space, but not the actual entries.

If you have deleted an entry that was referenced in a formula (see Part III, the VALUE ENTRY command), all entry positions with formulas with values referring to that position will display the message ERROR.

Example

- | | |
|-----------------------------|---|
| 1) Type /CY | To clear the worksheet. Cursor is at A1. |
| 2) Type 1 → 2 →
1 + B1 ↓ | The cursor is on B1. Your screen should look like this: |

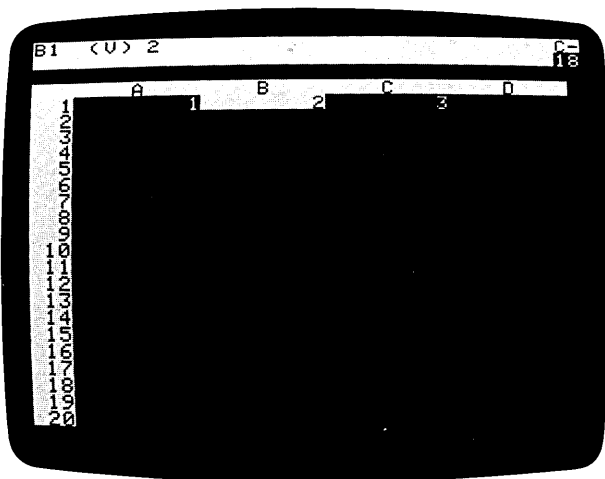

- 3) Type /D
- 4) Type C

prompt line: DELETE: R C
entry line: B1 (V) 1+ @ERROR
position B1: ERROR

All data in column B was deleted and the contents of column C moved over. At step 2, you entered a formula with a value reference, 1+ B1. The VisiCalc program replaced B1 with ERROR and alerted you by placing @ERROR in the entry position containing the formula.

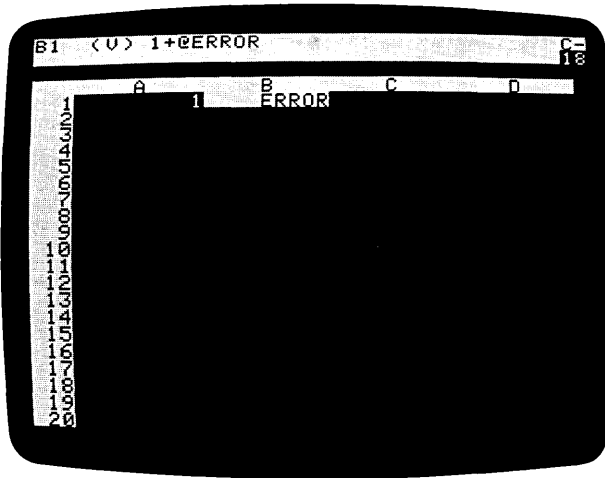

The EDIT Command

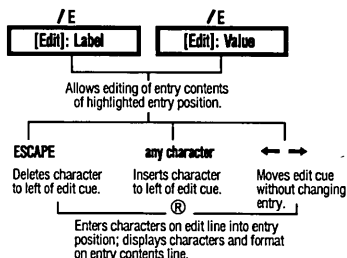

The Edit Command allows you to modify Labels or formulas without typing the entire value, formula or word over again. You may delete and insert characters at any position in the entry. This is especially helpful when you have a long or complex formula which needs to be changed.

You can use the Edit Command either to edit an entry that is already part of the worksheet, or to edit something you are currently entering on the edit line.

To edit an entry on the edit line use the following:

- 1) Type **CTRL E**. The prompt line will read:
[EDIT]: VALUE or [EDIT]: LABEL depending on the entry type. The edit cue remains where it was at the end of the entry.

Continue with steps 3-6 below.

To edit an entry you have already entered onto the worksheet use the following steps:

- 1) Place the cursor on the entry position with the entry you wish to change.
- 2) Type **/E** The prompt line will read:
[EDIT]: VALUE or [EDIT]: LABEL depending on the entry type. The entry from the entry line is displayed on the edit line with the edit cue on the first character.
- 3) Move the edit cue with the **→** and **←** keys until it is one character to the right of the character(s) you wish to change. In the Edit Command the **→** and **←** keys move the edit cue over the entry without changing it.
- 4) Delete characters to the left of the edit cue by pressing the **ESC** key.
- 5) Insert characters to the left of the edit cue by typing them in.
- 6) Press **Ⓜ** The prompt and edit lines clear, the new entry appears on the entry line and the label or value at the highlighted coordinate is changed accordingly.

The Edit command cannot change a label to a value or a value to a label. To do this you will have to type the whole entry with the appropriate beginning character (see Part III, LABEL ENTRY and VALUE ENTRY).

Example

- | | |
|---|---|
| <p>1) Type /CY</p> <p>2) Type MISTEAK</p>
<p>3) Type CTRL E</p>
<p>4) Press ⬅ twice.</p>
<p>5) Press ESC</p>
<p>6) Press ➡ twice.</p>
<p>7) Type E ®</p> | <p>Clears the screen and places the cursor at A1</p> <p>Entry line: LABEL</p> <p>edit line: MISTEAK</p> <p>The edit cue follows the K.</p> <p>prompt line: (EDIT): LABEL</p> <p>edit line: MISTEAK</p> <p>The edit cue follows the K.</p> <p>edit line: MISTEAK</p> <p>The edit cue highlights the A.</p> <p>edit line: MISTAK</p> <p>The edit cue still highlights the A.</p> <p>edit line: MISTAK</p> <p>The edit cue follows the K.</p> <p>entry line: A1 (L) MISTAKE</p> <p>prompt line: clear</p> <p>edit line: clear</p> <p>A1: MISTAKE</p> |
|---|---|

Example

- | | |
|---|---|
| <p>1) Type /CY</p>
<p>2) Type (S) 1 ➡ 2 ➡ 3 ➡</p> <p>4 ➡ 5 ➡ 6 ®</p> <p>> B1 ®</p> <p>10 ➡ 20 ➡ 30 ➡ 40 ➡</p> <p>50 ➡ 60 ®</p> <p>> C7 ®</p> <p>@SUM (A1.A5, B1.B5)</p> <p>®</p> | <p>Clears the screen and places the cursor at A1.</p> <p>Your screen should resemble the photo below.</p> |
|---|---|

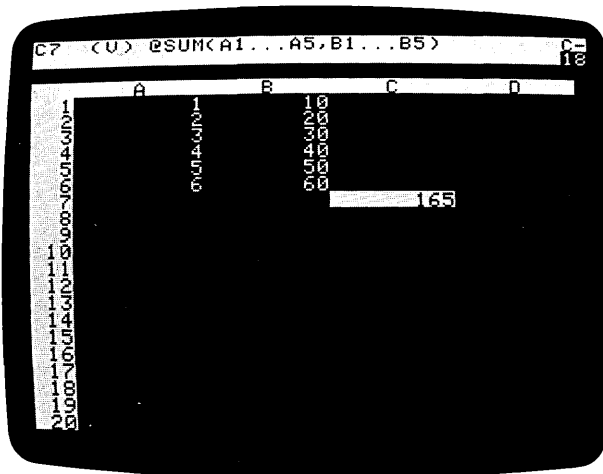

- | | | |
|----|------------------------------------|--|
| 3) | Type /E | prompt line: (EDIT): VALUE
edit line: @SUM(A1...A5,
B1...B5)
The edit cue is over the @.
C7: 165 |
| 4) | Press ↵ twelve times | edit line: @SUM(A1...A5,
B1...B5)
The edit cue is over the comma following A5. |
| 5) | Press ESC | edit line: @SUM(A1...A, B1...B5)
The edit cue remains over the comma. |
| 6) | Type 6 | entry line: @SUM(A1...A5,
B1...B5)
edit line: @SUM(A1...A6,
B1...B5) |
| 7) | Press ↵ eight times | Edit cue move to cover the). |
| 8) | Press ESC and type 6 | entry line: C7 (V)
@SUM(A1...A5,
B1...B5)
edit line: @SUM(A1...A6,
B1...B6) |
| 9) | Press Ⓜ | entry line: @SUM(A1...A6,
B1...B6)
prompt line: clear
edit line: clear
C7: 231 |

File Names

Any time you save a worksheet to a storage device, such as a diskette, you create a **file**. Every file on an individual diskette must have a unique **file name** to differentiate it from all other files on that diskette. The VisiCalc program uses standard Apple DOS conventions for file names and device suffixes.

When you save any file to diskette, the file name and where the file is located on the diskette are saved in that diskette's directory. If you were to save a file with a file name that you had already used, the more recent file would be written over the older file, erasing it. This is okay if you're updating the older file, but a complete loss of a file if you're not.

A valid file name must begin with a letter and be from 1 to 30 characters in length. A file name can include letters, numbers, the space character, and all punctuation *except* the comma (,). No other characters are allowed.

Valid file names would include **T, SALES: AUGUST1980**, and **UPDATE2.3.VC**. Invalid file names would be **1980 FORECAST** (begins with a number) and **SALES: AUGUST, 1980** (includes a comma).

You can create three types of files with the VisiCalc program: the standard worksheet file created with **/SS**; the Data Interchange Format (DIF) file created with **/S#S**; and the Print Format file created with **/PF**. See Part III, the STORAGE and PRINT Commands for details. You may on occasion have three files of the same data — one of each.

To protect yourself from confusion (or from writing over a file), we strongly urge you to place your own designators at the end of each file name. You might put **.VC** for the last characters of a standard worksheet file name, **.DIF** for Data Interchange Format file names, and **.PF** for Print Format file names. When you scroll through the file names, you can easily tell what type of file it is. You can use CTRL E to edit a file name on the edit line.

For example, you might want to take a file with the name SALES.VC and change it into the Print Format. When asked for the FILE NAME you would type **SALES.PF** to let you tell the two files apart and to be sure you do not lose the original file by writing over it.

Device Suffixes

Besides the file name proper, you can add "suffixes", separated from the file name by a comma, which tell the VisiCalc program which device (drive or interface card slot) to use when writing and reading files. The two device suffixes are **,Dn** and **,Sn**. The **D** stands for Drive, the **S** for Slot, and the **n** for number of the device. A device suffix can either follow a file name or it can stand alone.

When you load the VisiCalc program into the Apple, the default slot is normally slot 6 (unless you've located your Disk II controller card in another slot), and the default drive is drive 1. By **default**, we mean that the VisiCalc program always goes to these devices to read or write data.

Once you address a drive with a device suffix, it becomes the default drive. If you also address a slot, it becomes the default slot. Once you have used a device suffix, the VisiCalc program automatically looks to the most recently specified drive (and slot) whenever any drive command is given. It will continue to do so until you use another device suffix.

To return the default condition to drive 1, you must use **,D1** and, if necessary, designate the slot with **,S6**.

The **,Dn** suffix is necessary only if you have two drives. If, after loading the VisiCalc program from drive 1, you wish to use drive 2, you must invoke one of the Storage commands such as **/SL** or **/SS**. For example, if you wanted to load a file named **MYFILE.VC** from drive 2, you would type **/SL** and reply to prompt by typing **MYFILE.VC, D2** Ⓜ. You can also enter a device suffix without a file name to scroll in file names from another drive (see "Scrolling" below).

Slot suffixes identify interface cards, such as your printer card and Disk II controller card. If you have two Disk II controller cards, you may also specify a change of slot. For example, if you were using drive 1 in slot 6, and you wanted a file in drive 2, slot 5, you would need to supply the suffix **,S5, D1**.

Scrolling

To allow you to find and load or save your files more quickly, the VisiCalc program allows you to **scroll** through file names kept in the diskette's directory. To scroll in file names for VisiCalc files, type **/SL** then press either Ⓜ or ⏏. The drive will whirl and then display on the edit line the first name it finds in the diskette directory.

If the first file name to appear isn't the one you want, press ⏏ again. You can repeat this procedure until you have scrolled through every file name on the disk. To select a file for loading, simply press Ⓜ when the file name you want appears.

To scroll from a drive other than the default drive, you simply type the Storage command you want (like **/SL**) and the device suffix by itself. Then press ⏏ and begin scrolling through the file names.

You can also use scrolling to modify a file name already in the directory. For example, if you had loaded and modified a file called **SALES3.VC** and wanted the update version to be called **SALES4.VC**, you would type **/SS** ⏏ and continue to press the ⏏ until the name **SALES3.VC** appeared on the edit line. Then you would erase the **3.VC** with **ESC** and replace it with **4.VC**. The **.VC** is a reminder that **SALES4.VC** is a VisiCalc file. Press Ⓜ and the file will be saved under the revised file name. If you have an empty directory or scroll past the last name in the directory, the program returns to the command level.

The FORMAT Command

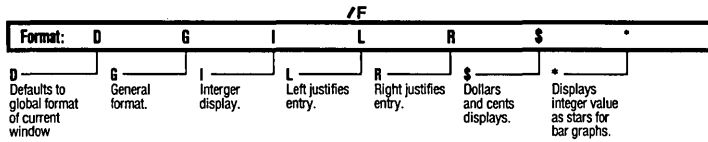

The Format command modifies the *display characteristics* of any highlighted entry on the VisiCalc worksheet. The actual entry contents (whether a label or value) remain unchanged in the computer's memory.

The actual values (with 11 or 12 place precision) are always used in calculations and are displayed completely on the entry contents line. Both the original contents and formatted display can be saved and reloaded using the /SS and /SL commands (see the STORAGE Command).

If the formatted entry is moved to another position on the worksheet (see Part III, the REPLICATE Command, the MOVE Command, and the INSERT Command), printed on paper or another device (see Part III, the PRINT Command), or stored on diskette (see Part III, the STORAGE Command) the appearance caused by the Format command will remain.

Once an entry position has been formatted, a format indicator will appear on the entry line between the current entry coordinates and entry contents. Erasing the contents of the entry position (see Part III, the BLANK Command) does not remove explicit formats, but clearing the worksheet (see Part III, the CLEAR Command) does.

To format a row or a column before making entries, format the first entry and then replicate the format (see Part III, the REPLICATE Command) into the rest of the row or column.

You cannot change the number of character spaces in an individual entry position. To change the number of characters in every column throughout the window, use the Global command for changing column width (see Part III, the GLOBAL Command).

We will use the following example to illustrate all of the Format command options. Type it in and, if you wish, save it to diskette with /SS (see Part III, the STORAGE Command) for quick reloading as you study the various options.

Example

1) Type /CY

This clears the worksheet, positions the cursor at A1, and resets all display characteristics to Global Format General.

2) Type LABEL ENTRY

◆ 1.23456789

◆ 99.999 ®

You now have one label and two values on your worksheet. Clearing the worksheet removed any explicit format settings and instated the Global Format General — the format that always comes into effect when you load the VisiCalc program (see Part III, the GLOBAL Command and the General Format Command below).

The Default Format Command: /FD

The Default Format command resets an individually formatted entry position to whatever format was previously set with the Global command (see Part III, the GLOBAL Command). If no global setting is in effect, the default will be the General Format, described in /FG below.

Load the basic example from above with /SL (see Part III, the STORAGE Command) or type it in. In our /FD illustration, we will first set the global format to dollars and cents, then set entry position C1 to integer format. Finally, we will default to the global dollars and cents format.

Example

- | | | |
|---------------|---|---|
| 1) Type /GF\$ | entry line:
position B1
position C1 | C1 (V) 99.999
1.23
100.00
The cursor remains at C1. The entire sheet is in dollars and cents format. |
| 2) Type /FI | entry line:
position B1:
position C1: | C1/FI (V) 99.999
1.23 (unchanged)
100
The cursor remains at C1 where the entry has been changed to integer format. B1, however, was not changed. |
| 3) Type /FD | entry line:
position C1: | C1 (V) 99.999
100.00
The default setting is dollars and cents because that was the last <i>global</i> setting. |

Note that even though we displayed the entry at C1 in three different formats, the actual value — as shown on the entry line — remained the same. Also, if we hadn't included step 1, the default format would have been the general format.

The General Format Command: /FG

The General Format command sets an entry position to the same format that is in effect when you load the VisiCalc program. Decimal or scientific notation is selected to display the largest number of significant digits. Labels begin in the leftmost space (left-justified) and are cut off wherever the column width ends. Values are moved as far to the right as possible (right-justified) with a leading blank character in the leftmost position in the column.

In this example, we will change the entire worksheet to the integer format and then set entry position C1 to the general format. Position B1 (along with the rest of the worksheet) will remain in the global integer format. To study this example, either load in the basic example from diskette with */SL* (see Part III, the STORAGE Command) or type it in. Then continue with the steps below.

Example

- 1) Type */GFI*
- | | |
|--------------|---------------|
| entry line: | C1 (V) 99.999 |
| position B1: | 1 |
| position C1: | 100 |
- The integer format is in effect on the entire worksheet and has rounded both entries.
- 2) Type */FG*
- | | |
|--------------|-------------------|
| entry line: | C1 /FG (V) 99.999 |
| position B1: | 1 |
| position C1: | 99.999 |
- The local format for C1 is general and so our value is displayed just as it was under the *global* general format. B1, however, continues to display in the global integer format.

The Integer Format Command: /FI

The Integer Format command displays all values rounded to the nearest whole number. To study the example, load the basic example with */SL* (see Part III, the STORAGE Command) or type it in, then follow the steps below.

Example

- 1) Type */FI*
- | | |
|--------------|-------------------|
| entry line: | C1 /FI (C) 99.999 |
| position B1: | 1.234568 |
| position C1: | 100 |
- The value at C1 has been rounded to the nearest integer. B1 remains unchanged under the global general format.

The Left Justification Format Command: /FL

The */FL* command pertains *only* to values (numbers and formulas) because the VisiCalc program automatically left-justifies all labels. Values, on the other hand, are always right-justified in the general format.

When you type */FL* the value highlighted by the cursor moves to the left preceded by one leading blank. This command affects only the display of entries on the worksheet that have fewer characters than the current column width. Left-justifying a value entry will turn off an explicit integer format (*FI*) setting for that entry position.

To study this command, load the basic format example from diskette with */SL* (see the STORAGE Command) or type it in. Then follow the steps below. Steps 2 and 3 are optional; they allow you to see the effect that */FL* has on integers. Be sure to watch the screen when you type */FL* to see the entry actually move to the left.

Example

- 1) Type **/FL**
 - entry line C1 /FL (V) 99.999
 - position B1: 1.234568
 - position C1: 99.999
 - The value in C1 shifts to the left with its leading blank.
- 2) Type **/FI**
 - entry line: C1 /FI (V) 99.999
 - position B1: 1.234568
 - position C1: 100
 - The integer format rounds the value at C1 to 100 and shifts it back to the right of entry position C1.
- 3) Type **/FL**
 - entry line: C1 /FL (V) 99.999
 - position B1: 1.234568
 - position C1: 99.999
 - The entry value is restored and moved to the left of position C1 with the leading blank.

The Right Justification Format Command: /FR

The Right Justification command will move a label to the right of its entry position. It will do the same thing to a value that has been left-justified. This command affects only the display of entries on the worksheet that have fewer characters than the current column width.

To study this command, load the basic example from diskette with **/SL** (see Part III, the STORAGE Command) or type it in. Then follow the steps below.

Example

- 1) **>A2** Ⓜ cursor resets at A2
 - 2) Type **LABEL** Ⓜ entry line: A2 (L) LABEL
 - 3) Type **/FR** entry line: A2 /FR (L) LABEL
 LABEL shifts to the right of entry position A2.
 - 4) Type **>A1** Ⓜ entry line: A1 (L) LABEL ENTRY
 position A1: LABEL ENT
 - 5) Type **/FR** entry line: A1 /FR (L) LABEL EN-
 TRY
 position A1: LABEL ENT
- Note that because the label fills all of position A1 no shift to the right took place. However, the entry line shows that the **/FR** format is still in force. Thus, if you widened the worksheet columns (see Part III, the GLOBAL Command) to 12 characters or blanked A1 (see Part III, the BLANK Command) and typed in a label less than nine characters in length, you would see right justification take place.

The Dollars and Cents Format Command: /F\$

The /F\$ command rounds all values to two decimal places. It also adds two decimal places (.00) to integers and an extra 0 to values with just one decimal place. However, no \$ is displayed in the entry position. The command has no effect on labels.

To use this example, either load the basic format example from diskette with /SL (see Part III, the STORAGE Command) or type it in.

Example

1) Type /F\$	entry line:	C1 /F\$ (V) 99.999
	position C1:	100.00

The Bar Graph Format Command: /F*

The Bar Graph command acts as if nothing exists to the right of the decimal point; it truncates all values down to integers. That integer is replaced in the entry position by an equal number of stars.

The greatest number of stars possible in an entry position is the width of the entry position minus one (for the leading blank). Thus, the maximum number of stars that the VisiCalc program can display in a 9 character wide position is eight.

To see the bar graph command in action, load the basic format example from diskette with /SL (see the STORAGE Command) or type it in. Then follow the steps below.

Example

1) Type ⏏	To move the cursor to position B1
2) Type /F*	entry line: B1 /F* (V) 1.23456789
	position B1: *

The GLOBAL Command

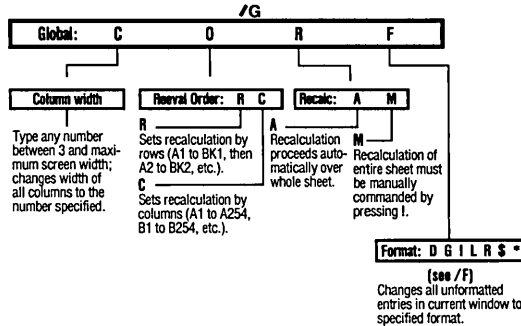

The Global command's four options operate in one window at a time. If you have split your screen, only the window in which the cursor resides will be affected. If you have a single window, the Global command will affect the entire worksheet.

The Global Column Command: /GC

The Global Column command allows you to change the width of all columns in a window to any number of characters between 3 and 37 (the maximum width of your screen minus 3 for the row border). Column widths may not be set individually.

The VisiCalc program will display as many whole columns of a given width as possible on the screen. Use of column width that is half the maximum width of the screen will cause the automatic removal of any vertical title areas (see the TITLES Command).

Use of the Global Column option may change the appearance of some entries from the way you originally entered them on the edit line. Labels may be truncated to fit narrower columns. Value displays may be affected in any one of three ways:

- 1) The VisiCalc program will round off numbers when necessary to fit them inside narrower column widths.
- 2) The VisiCalc program may display a number in scientific notation if this will permit more significant digits to be shown at the narrower column width.
- 3) The VisiCalc program will replace integers with as many > signs as possible (with a leading blank) if it cannot place a complete decimal or exponential number in the narrowed display area.

Note, however, that the Global Column command only changes the *appearance* of values, not the actual values stored in memory. These values remain unchanged and will be used in all calculations.

The value, as you originally entered it on the edit line, will be displayed on the entry line whenever the cursor is over that value's entry position. To

enter the value appearing on the entry line onto the edit line, place the cursor on the entry position and press #. The prompt line must be clear to do this.

Example

- | | |
|----------------------------------|---|
| 1) Type /CY | This clears the worksheet, resets column width to 9, and puts the cursor at A1. |
| 2) Type THIS LINE IS TOO LONG. ® | entry line: A1 (L) THIS LINE IS TOO LONG. |
| 3) Type /G | prompt line: GLOBAL: C O R F |
| 4) Type C | prompt line: COLUMN WIDTH |
| 5) Type 18 ® | entry line: A1 (L) THIS LINE IS TOO LONG. |
| | position A1: THIS LINE IS TOO L |
| 6) Type /GC24 ® | entry line: A1 (L) THIS LINE IS TOO LONG. |
| | position A1: THIS LINE IS TOO LONG. |
| | position B1: not displayed. |

Example

- | | |
|---------------------------|--|
| 1) Type /CY | |
| 2) Type 123456789 ® | entry line: A1 (V) 123456789
position A1: 1.2346E8
Note the leading blank, scientific notation, and final digit rounded up. |
| 3) Type ↵
1.23456789 ® | entry line: B1 (V) 1.23456789
position B1: 1.234568
Note the leading blank and the final digit rounded up. |
| 4) Type /GC3 ® | entry line: B1 (V) 1.23456789
position A1: > >
position B1: 1.
The number in A1 is too large to express with two characters, which is the space available for digits when the column width is 3, displays > >. The number in B1 is rounded as shown with decimal point appearing. |

The Global Order of Recalculation Command: /GO

The Global Order of Recalculation allows you to tell the VisiCalc program whether it should recalculate by rows or by columns. The order of calculation is indicated on the status area by the letter C or R in the upper right hand corner of the entry line. When you first load the VisiCalc program, the order is set to column calculation.

When the VisiCalc program calculates in column order, it begins at coordinate A1 and then works down column A until it comes to the final entry.

Then it jumps to coordinate B1 and works its way down that column. This process continues until all values are calculated (or recalculated).

In row calculation, the VisiCalc program begins at A1, but then continues out Row 1 (B1, C1, D1, etc.) until the last value in that row is calculated. Then it jumps to A2 and begins calculating row 2 in the same way. This process continues until all values are calculated (or recalculated).

If the VisiCalc program appears to evaluate formulas incorrectly, you have probably placed formulas in entry positions where they are calculated before the values in the references that they contain (a condition called "forward references"). Order of calculation and recalculation are discussed at length in Part III, the VALUE ENTRY Command and also in Part II, Lesson Three, in the section entitled "The Order of Recalculation".

The following example illustrates the use of value references set up for column calculation and shows what happens when they are calculated by row.

Example

- 1) Type /CY This clears the worksheet and sets column calculation.

- 2) Type (S)1 ⬇ + A1 Ⓜ
- 3) Type > B1 Ⓜ
- 4) Type + A2 ⬇ + B1 Ⓜ Your screen should look like this:

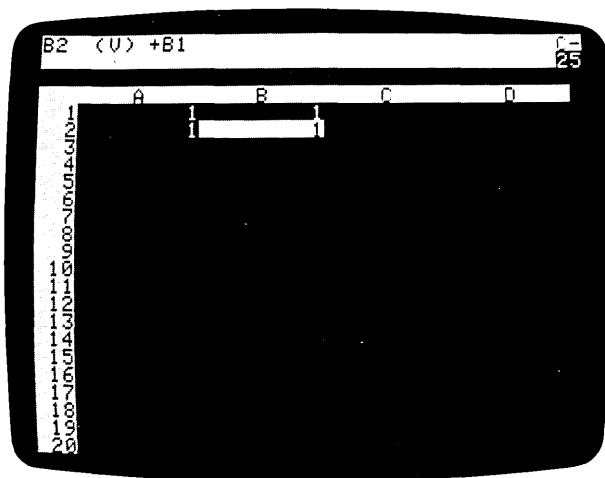

5) Type >A1® 2®

The value at A1 is changed to 2, and the other values are recalculated. Your screen should look like this:

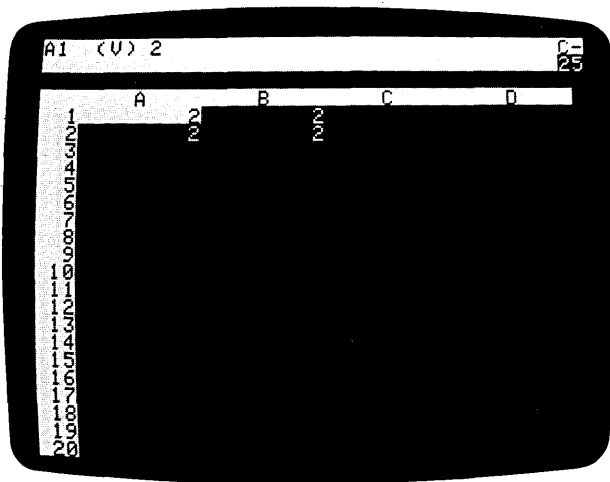

6) Type /GOR

The order of calculation indicator changes to R.

7) Type 3®

Your screen should look like this:

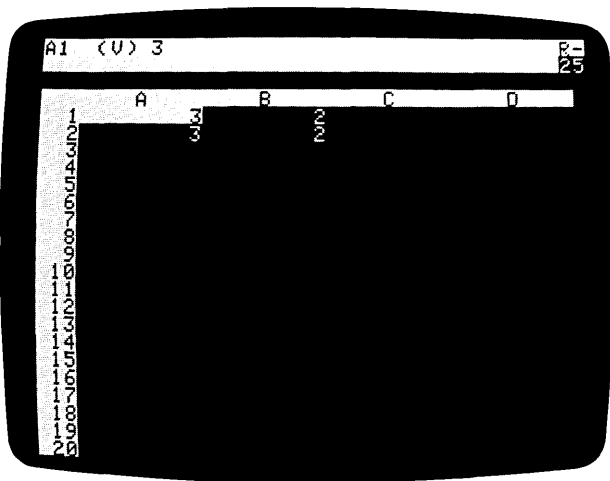

This is incorrect. B1 should be the same as A2, yet it displays a different value because B1 was recalculated *before* A2 was recalculated. In such instances, you can force a recalculation by pressing ! when the prompt line is blank. Press it now and the screen shows the correct values as in the photo below.

Note that you can make forward and circular references without getting an immediate ERROR message. However, if you save the worksheet and reload it, it will display ERROR at the appropriate entry positions. In such a case, you must also force a recalculation by typing !

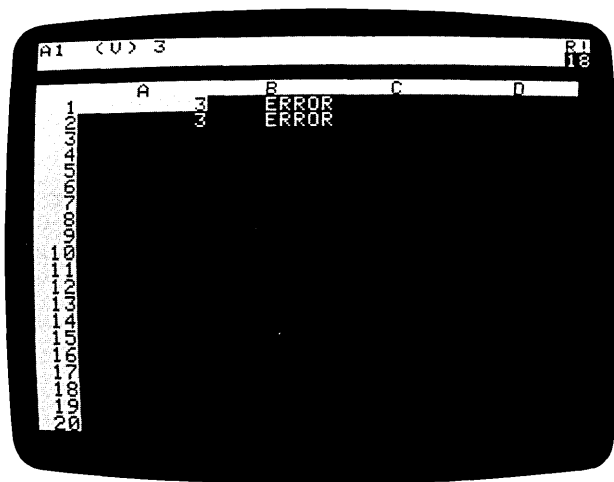

A similar example that works correctly for row order of calculation, but not for column order, is this:

Example

- 1) Type /CY
- 2) Type /GOR
- 3) Type 1 ⬇ + A1 Ⓜ
> A2 Ⓜ + B1 ⬇
+ A2 Ⓜ
- 4) Type > A1 Ⓜ 2
Ⓜ 3 Ⓜ
- 5) Type /GOC
- 6) Type 4 Ⓜ

The worksheet is cleared and calculation is set to column order.

To change to row order of calculation.

Note how the four coordinates relate differently than in the previous example.

The results are correct.

To change to recalculation by columns.

An error results similar to the one in which a column-oriented group of numbers were by rows.

The Global Recalculation Command: /GR

The Global Recalculation option allows you to turn off automatic recalculation in favor of manual recalculation. For example, you might use manual recalculation when you are typing in a column or row of figures. By turning off automatic recalculation, you eliminate the pause that occurs when the VisiCalc program is recalculating.

To do this, type **/GRM** (for Global Recalculation Manual). Under manual recalculation, only the highlighted formula will be recalculated automatically. To update the whole worksheet you must force a recalculation by typing **!**

Note: The use of **!** does not take you out of manual recalculation. There is no cue on the status area to indicate whether you are in manual or automatic recalculation, but the status should be evident from watching the behavior of the worksheet. To resume automatic recalculation, type **/GRA** (for Global Recalculation Automatic).

The Global Format Command: /GF

Global Format allows you to assign a format setting to all entry positions in the window that you have not formatted individually. The Global Format command uses the same formatting options as are available for individual entry positions. See Part III, the **FORMAT** Command, for an explanation of these options and instructions on how to format individual positions. Setting the Global Format to Default (**/GFD**) has no effect on the screen.

If you have split your screen into two windows (see Part III, the **WINDOW** Command), you may use a different global format for each window. When you save your worksheet with **/SS** all global formats are also saved (see Part III, the **STORAGE** Command).

The GO TO Command

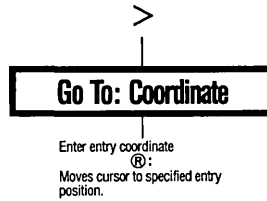

The Go To command lets you jump the cursor quickly from one entry position to another without scrolling the window. Note that the Go To Command offers the only way to jump over a border created by the TITLES command (see Part III, the TITLES Command).

To move the cursor to a new entry position, type the Go To command (>) followed by the coordinates of the entry position to which you want to jump and press ®

Example

- 1) Type > prompt line: GO TO: COORDINATE
- 2) Type **AM205** ® The cursor will jump to column AM, row 205.

The INSERT Command

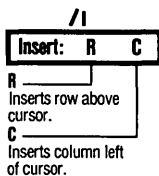

The Insert command opens up additional rows or columns in worksheet areas that you have already written in. For example, if you were creating an expense worksheet and left out a category, you could use Insert to open up an entire row or column wherever you need it.

The Insert command begins with /I and offers you two choices. Type **R** if you want a row inserted or **C** to insert a column. It is not possible to insert a single entry position — you may only insert an entire row or column.

The Insert Row Command: /IR

/IR inserts a new, blank row at the row in which the cursor is situated when you give the command. All rows that were at or below the cursor are moved down one row to make room for the insertion.

The VisiCalc program then changes all value references in formulas to reflect the new entry position coordinates in the rows that were moved. For example, if a formula contains the coordinate C2, and you insert a row at row 2, VisiCalc will change the coordinate to C3. The cursor will remain in its old position in the new, blank row. We will use the following example to illustrate both the /IR and /IC commands.

Example

1) Type /CY

To clear the screen and set the cursor to position A1.

2) Type VALUE ↵ 1 ↵ 2

↵ 3 Ⓜ

> A2 Ⓜ

FORMULA ↵

+ B1 + C1 ↵

+ C1 + D1 Ⓜ

> A3 Ⓜ SUM ↵

+ B1 + B2 ↵

+ C1 + C2 Ⓜ (S)

Compare your screen after step 2 to the photo below. Note that the entry lines shows + C1 + C2

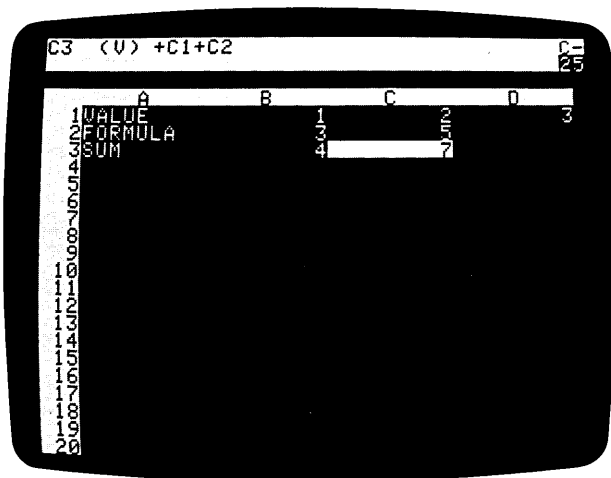

- 3) Type \uparrow
- 4) Type /IR

Cursor moves up to position C2.
 Row 2 (the row in which the cursor rests) is pushed to row 3 leaving a blank column at row 2.

- 5) Press $\rightarrow \rightarrow$

entry line: C4 (V) + C1 + C3
 Note that our formula has changed to reflect the inserted row — from +C1+C2 to +C1+C3. If you intend to do the /IC example, continue with step 6.

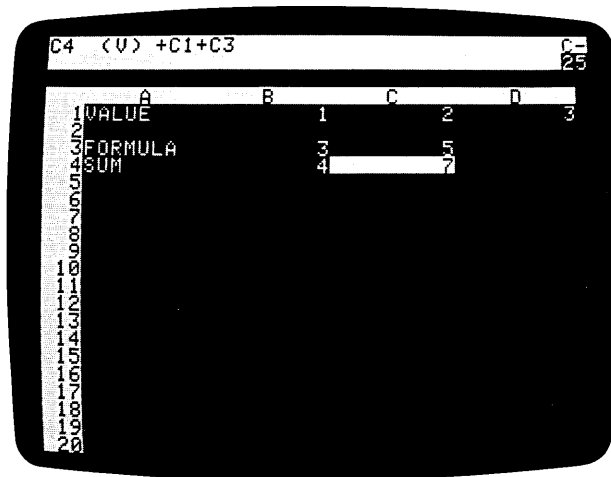

- 6) Press $\leftarrow \leftarrow \text{/DR} \rightarrow$

The Insert Column Command: /IC

/IC inserts a new, blank column at the column in which the cursor is located when the command is given. All columns at and to the right of the cursor are moved one column to the right to make room. The VisiCalc program changes all value references in formulas to reflect the new entry position coordinates for the columns that were moved. The cursor remains in its original position in the new, blank column.

Example

If you do not have the **/IR** example on your screen, type in steps 1 and 2 from above before continuing.

- 3) Type **↩** The cursor moves to position C2. The entry line shows the formula $+C1 + D1$.
- 4) Type **/IC** Column C (the column at which the cursor rests) shifts right into column D leaving a blank column at column C.
- 5) Type **(S) ↩** entry position: D2 (V) $+ D1 + E1$
Note that the formula has changed to reflect the inserted column — from $+C1 + D1$ to $+D1 + E1$. Compare your screen with the photo below.

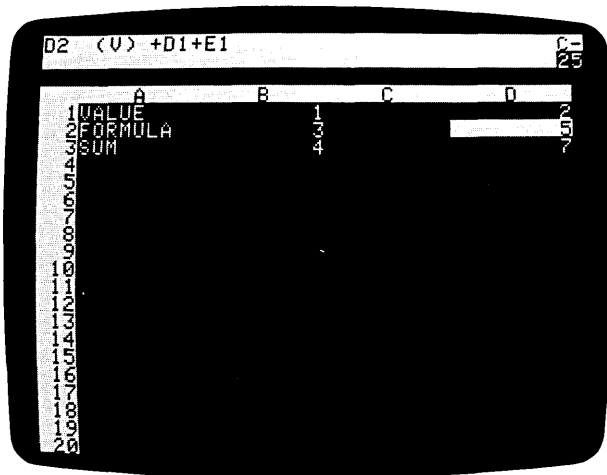

Note that when inserting into a built-in function range (such as **@SUM**), the formula and range will expand to include your insertion (whether row or column) providing that you obey two rules.

First, *never* use the Insert command at the first item in the range. Second, *never* place the insertion at the row or column that contains the built-in function formula. Both of these positions will leave your insertion out of

range for purposes of calculation. For more information on ranges and built-in functions see Part III, the VALUE ENTRY Command.

Note further that the VisiCalc program will not allow you to insert a row if row 254 is occupied, nor will it allow you to insert a column if column BK is occupied.

If row 254 or column BK has been occupied, the worksheet will remain expanded to that size (see Lesson Two, Postscript: Memory and the Electronic Sheet). In order to insert rows or columns in this situation, you use the Move command to transport any data in either row 254 or column BK to another part of the worksheet. Then shrink the worksheet with /SS and /SL (See Lesson Two, Shrinking the Sheet). You will then be able to insert.

The LABEL ENTRY Command

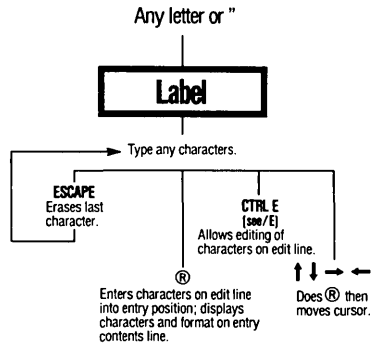

A label is any entry beginning with a letter or a quote. In fact, the VisiCalc program will evaluate any label as a 0 (zero). Usually, a label is used to give some information about rows and columns. All alphabetic and numeric characters, as well as punctuation and arithmetic operators are allowed in a label. Control characters, however, cannot be included.

You can begin the Label Entry command when the prompt and edit lines are clear. The label will be entered in the entry position on which the cursor rests when you begin the Label Entry command. When the first character of the label is alphabetic, just begin typing the label. The VisiCalc program immediately recognizes that you are entering a label.

However, if the first character is a digit (2ND MONTH) or one of the arithmetic operators (-GROSS-) that automatically begins a Value Entry (see Part III, the VALUE ENTRY Command), you must type a quotation mark (") as the first character in the label. The " will not appear as part of the label.

As soon as you have pressed either the " or a letter, the prompt line will display LABEL. The characters of the label will appear on the edit line and in the entry position. Press **ESC** to erase any mistyped characters. With the error(s) thus removed, simply type in the correct characters. You can also type **CTRL E** to enter the Edit command and change the characters on the edit line.

When the label is complete, terminate the command with either **Ⓜ** or any arrow key. The label will appear in the entry position with the first character at the left side of the column and will have replaced anything that you may have previously placed in that position.

You may display the label at the right of its entry position by using the **/FR** command (see the **FORMAT** Command reference). The entry line will display the indicator (L) whenever the cursor is on an entry position containing a label.

If you type a label that has more characters than the current column width will accommodate (see Part III, the **GLOBAL** Command) only the column

width number of characters will be displayed in the entry position. The entire label is kept in memory and displayed on the entry line (assuming the label is not too long for the entry line).

If you want to display a long label on the worksheet, you can use two or more columns to type it. When you fill the first entry position, press **↵** (assuming the direction indicator is -) and continue typing. If you need more column space, just continue this procedure.

Example

- | | |
|-----------------------|---|
| 1) Type > A1 Ⓜ | Places the cursor at A1. |
| 2) Type P | prompt line: LABEL
edit line: P |
| 3) Type ERIOD | entry line: A1
prompt line: LABEL
edit line: PERIOD |
| 4) Press Ⓜ | entry line: A1 (L) PERIOD
prompt line: clear
edit line: clear |
- Or press an arrow key The label is entered and the cursor is on the next entry position.

Suppose you want to use a label that looks like a formula.

Example

- | | |
|--|---|
| 1) Type > B1 Ⓜ | To place the cursor at B1. |
| 2) Type " | prompt line: LABEL
edit line: clear
The " does not appear but tells the VisiCalc program this entry is a Label. |
| 3) Type .575*B2 | prompt line: LABEL
edit line: .575*B2 |
| 4) Press Ⓜ or an arrow key (if direction indicator is ! a ↵ would be invalid in this case). | entry line: B1 (L) .575*B2
prompt line: clear
edit line: clear |

The (L) on the entry contents line in step 4 of the above example indicates a Label Entry and allows you to distinguish it from a Value Entry.

The MOVE Command

/M

Move: From . . . To	
Enter second coordinate within same column.	Enter second coordinate within same row.
Ⓡ	Ⓡ
Row containing first coordinate moves to row above second coordinate.	Column containing first coordinate moves to left of column containing second coordinate.

The Move command allows you to move an entire row or column to another position on the electronic sheet. The VisiCalc program will automatically change all value references in formulas (see Part III, VALUE ENTRY Command) to reflect the new coordinates that result when the rows or columns are moved.

However, you must be careful not to move any formula that contains a value reference to a position at which the formula is calculated before its value reference(s). For a complete discussion concerning order of calculation and recalculation, see the Part III, VALUE ENTRY Command Reference and the sections entitled "The Order of Recalculation" and "Forward and Circular References" in Lesson Three.

Moving a Row

To move a row, you must first place the cursor on the row you wish to move. The precise position in the row doesn't matter. What does matter is that you specify the same *column* coordinate for the new location as you did for the old location. For instance, moving C10 to C5 is valid, but moving C10 to D5 is not, because the column is different.

Second, type /M The entry contents line will display the words MOVE: FROM...TO. The edit line simultaneously shows the "FROM" coordinate (the current cursor position).

Press . as the delimiter and three dots will appear on the edit line after the "FROM" coordinate. Then either type in the destination coordinate or point the cursor to it. Terminate the Move command with Ⓡ The command will open a new row at the destination and close up the space caused by moving the row.

Once the Move command completes its work, the cursor jumps back to the beginning coordinate. This feature can be very handy, particularly when you have a very complex sheet; it helps you keep track of your starting point in case you've moved the wrong row or column.

If you want to move a row **downward**, place the cursor in the row just *below* the destination coordinate. If you want to move a row **upward**, place the cursor directly on the destination row.

Example

- 1) Set up your sheet as in the photo:

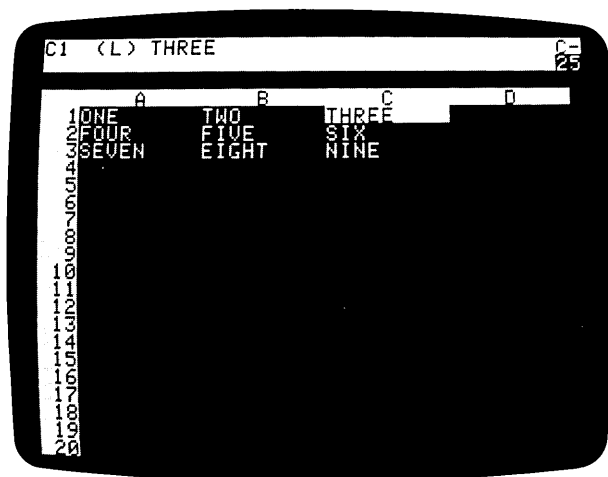

- | | | |
|--------------|--------------|----------------------------------|
| 2) Type /M | prompt line: | MOVE:FROM...TO |
| | edit line: | C1 |
| 3) Type . | edit line: | C1... |
| | | To move row 1. |
| 4) Press (S) | edit line: | C1...C4 |
| ♦ ♦ ♦ | | Row 1 will move to |
| | | row 3. |
| 5) Press ® | | The sheet should look like this: |

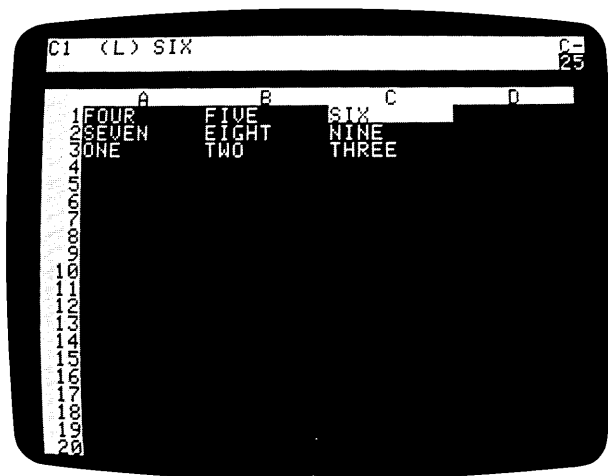

When you move a row upward, row 3 to row 2 for instance, either point with the cursor or type in the *precise* coordinate of the target row. To illustrate this, let's place row 3 back in its original position.

Example

- 1) Press **→ →** To position the cursor at C3. The direction indicator should be !.
- 2) Type **/M** prompt line: MOVE: FROM ... TO
edit line: C3
- 3) Type **.** edit line: C3 ...
Row 3 will be moved.
- 4) Press **← ←** edit line: C3 ... C1
Row 3 will move to row 1.
- 5) Press **Ⓜ** Row 3 has moved to row 1, and the cursor jumps back to C3. See the photo below.

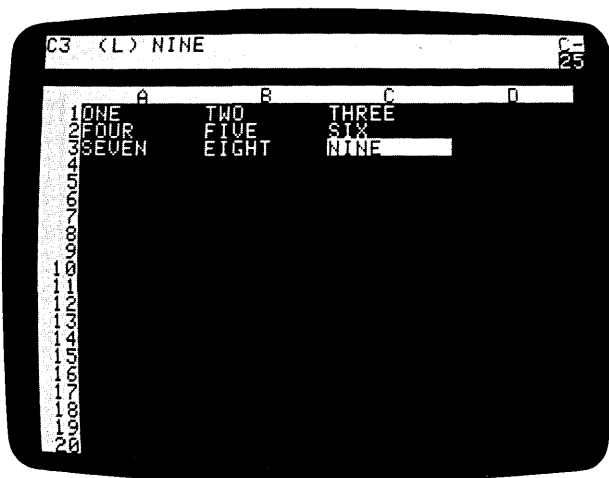

Moving a Column

To move a column **to the right** of its current position, first place the cursor on the column you wish to move. Type **/M** and the coordinate of the highlighted entry position will appear on the screen. Press **.** and then point to or type in the coordinates of the column just *to the right* of the destination column. Terminate the Move command with **Ⓜ** and the column will be moved to the desired position — just to the left of the cursor.

When moving columns, the cursor can be in any position within the column when you start the command, but when you indicate the new location, you must use the same row coordinate. For example, moving A2 to D2 is valid, but moving A2 to D1 is not. Terminate the Move command with a **Ⓜ**. All intervening columns are moved over to fill the place vacated by the moved column. The cursor jumps back to its starting position.

Example

- 1) Type ONE ↵ TWO ↵
THREE ↵ FOUR Ⓜ
> A1 Ⓜ
/R.D1 Ⓜ A2.A5 Ⓜ

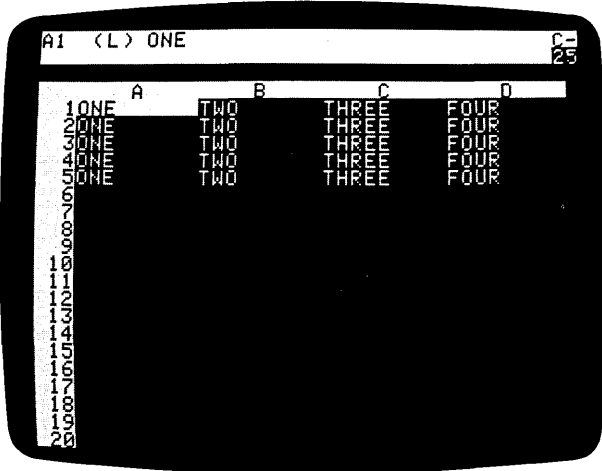

- 2) Type /M prompt line: MOVE: FROM...TO
- 3) Press . edit line: A1
- 4) Type D1 Or edit line: A1...
- ↵ ↵ ↵ edit line: A1...D1
- 5) Press Ⓜ

Column A has been moved to column C as in the photo below.

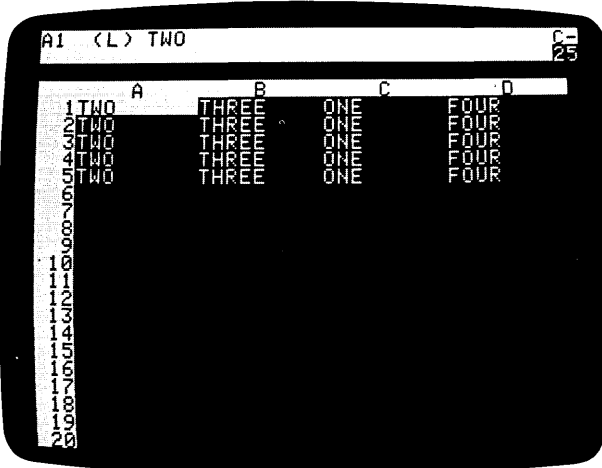

When you move a column to the left of its present position, either point with the cursor or type in the *precise* coordinate of the target row.

Example

- | | |
|---|--|
| <ol style="list-style-type: none"> 1) Type > C1 Ⓡ 2) Type /M 3) Press . 4) Press ⬅ ⬅ 5) Press Ⓡ | <p>To position the cursor at C1.
 prompt line: MOVE: FROM...TO
 edit line: C1
 edit line: C1...
 edit line: C1...A1
 Column C has moved to column A as shown in the photo below.</p> |
|---|--|

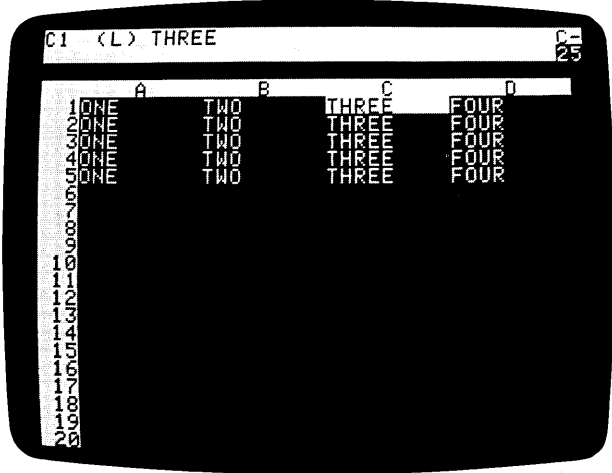

You can also type in the coordinate of the row or column to be moved, as well as the coordinate of the new location. Use the **ESC** key to erase any unwanted coordinate. Replace it either by typing in or pointing to the coordinate with the cursor.

Example

- 1) Type /M prompt line: MOVE: FROM...TO
- edit line: C1
- 2) Press ESC prompt line: MOVE: FROM...TO
- edit line: clear
- 3) Type A1 edit line: A1
- 4) Press . edit line: A1...
- Cursor returns to D1.
- 5) Type D1 edit line: A1...D1
- Column A will be moved to column C.
- 6) Press @ The contents of column A are now in C. The
- columns that were previously B and C have
- been moved to A and B.

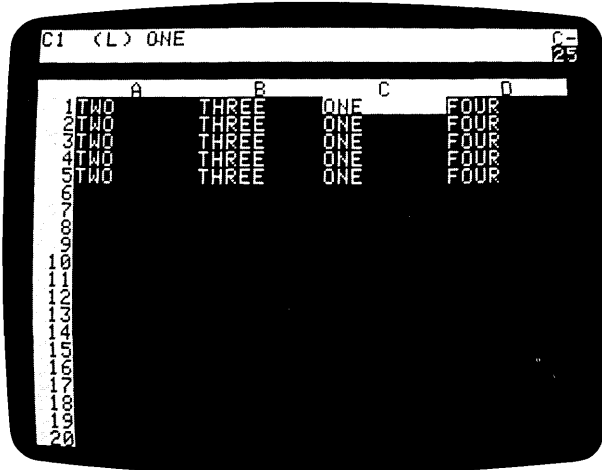

The PRINT Command

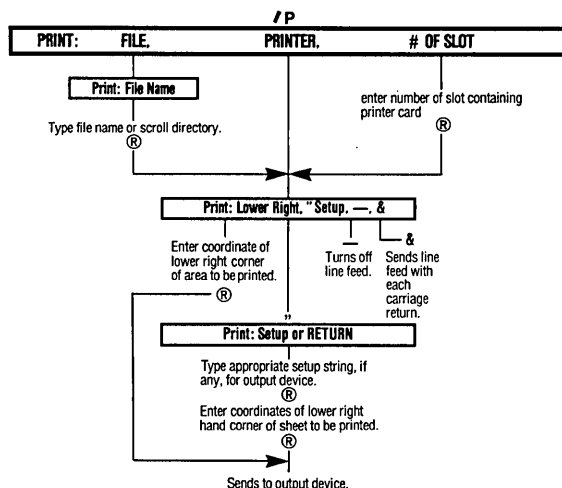

The purpose of the Print command is to allow you to print your worksheets either to a line printer for hard copy or to another device, such as a disk drive.

Because of the many different combinations of printers and printer interface cards, you may have to experiment to get a printout that meets your format specifications. This is not particularly difficult if you properly set up your printer, printer interface card, and Apple *before* attempting to print out a worksheet.

You may already have various switches on your card and printer set for certain kinds of jobs (like word processing). Leave them alone for the time being. The VisiCalc Print command has a number of options that — in most cases — allow you to set up formats without touching switches.

Setting Up and Testing

The following steps are *general guidelines* to help you set up your equipment and make sure that your printer is receiving and printing data from your Apple. Before you begin, get out your printer and interface card manuals.

- 1) Make sure the Apple and the printer are turned OFF.
- 2) Go through your printer and interface card manuals and make sure that you've correctly set all relevant switches — particularly the DIP switches (if any) on the interface card. You may want to make a check

list of these settings for testing and reference purposes. Pay particular attention to anything involving:

- a) Carriage return
 - b) Line feed
 - c) Line spacing
 - d) Parity and Baud rate (if this is the first time you've hooked up the printer, card, and Apple).
 - e) Number of characters per line.
- 3) See your printer interface card manual to install the card. Look to see that your printer interface card is in one of the slots numbered 1 through 7 (slot 0 is reserved for language cards only). Slot 1 is considered the "standard" slot for printer cards.
 - 4) Make sure that the cable from the interface card to the printer is properly connected at both ends.
 - 5) Check to see that the printer and the Apple are plugged in.
 - 6) Make sure that you have an adequate amount of paper and that it is in the correct position.
 - 7) Turn the Apple and the printer ON. If your printer has an "ON LINE" switch (sometimes called "LINE" or "SELECT") make sure that it too is ON.
 - 8) Consult your manuals to help you get the BASIC prompt on your screen (> for Integer BASIC,] for Applesoft BASIC) followed by the flashing cursor.

If you have followed the steps above you are ready to *test* your printer. If your manuals do not suggest any tests, try this one. Type the following BASIC program exactly.

```

NEW ®
10 REM PRINT TEST PROGRAM ®
20 FOR I = 1 TO 10 ®
30 PRINT "THIS IS A TEST TO SEE HOW WELL MY APPLE AND MY
  PRINTER WORK TOGETHER" ®
40 NEXT I ®
50 END ®

```

Type **RUN** to see the program on your screen. You should see the words
THIS IS A TEST TO SEE HOW WELL MY APPLE AND MY PRINTER WORK
TOGETHER

repeated ten times. Note that this sentence is over 40 characters long. If your printer is set to a 40 character line, the second line will begin with AND. Now let's see if the printer accepts data from the Apple and the form in which it will print out the program.

Type **PR#1** ® **RUN** ® If your printer card is in a slot other than 1, type its slot number instead of 1. Note: once you've typed **PR#1** ® , the printer should print out anything you type in from your Apple keyboard.

Three important things to watch for are **carriage return**, **line feed**, and **line width**. First, does the printer *return* to the left margin when it finishes printing a line? If it does, carriage return is in effect.

Many printers have an automatic carriage return button to turn this feature on and off. If your printer doesn't issue a carriage return, don't worry. Just keep in mind that the VisiCalc program can provide a carriage return.

Second, does the printer also drop down to the next line to continue printing? If it does, line feed is turned on. If you have line feed, is it single spacing down, or double spacing, i.e., are you getting one or two line feeds? Take note of these peculiarities now to help you give the VisiCalc program proper printing instructions. The VisiCalc program can provide as well as cancel line feed.

Third, you should note whether your printer printed the sentence all in one line or broke the sentence after 40 (or some other number of) characters. The VisiCalc Print command allows you to send commands that extend or decrease the length of a line (assuming that your printer can print lines that are more than 40 characters long and that the printer card accepts such commands).

Many printers and cards allow you to type in special command character strings (a string is simply a group of characters). These strings, called **setup strings**, can cause the printer to do a number of things — double space, change line width and margins, etc. Check your printer manual and your interface card manual to see what options you can use.

We recommend that you use this test to set up your printer and interface card so that you are getting a carriage return, a line feed, and at least an 80 character line (if possible). If you can't get the printer to respond to the Apple, or if you are getting odd results, check your interface card and printer manuals. If that doesn't solve the problem, see your dealer.

From this point on, we will assume that your Apple is able to send data to your printer and that the printer can print it.

Printing to a Printer

With two exceptions, the Print command exactly reproduces a rectangle of information from your worksheet just as you see it on the screen. Formats and column widths will remain in effect.

The exceptions are (1) windows; and (2) rows and columns that you have Titled (see Part III, the WINDOW Command and the TITLES Command). The **/P** command will ignore windows (see Part III, the WINDOW Command) and print out the worksheet as if you had typed **/W1** before issuing the **/P** command.

The Print command will not print columns or rows fixed by the Titles Command (see Part III, the TITLES Command). It prints the worksheet as if you had typed **/TN**. Many VisiCalc users find it easier to define the portions of the sheet to be printed without the Titles command in effect. You might want to turn your titles off with **/TN** while executing the Print command and reset them afterwards.

The first two steps in printing out a VisiCalc worksheet are universal to all printers and interface cards. Assuming that you already have a worksheet on the screen, follow the steps below.

- 1) Type **>A1** To place the cursor in the upper left corner of the worksheet. This is the first step in defining the rectangle that will be printed out. If the upper left corner of the rectangle you want to print out is other than A1, then place the cursor at that coordinate.
- 2) Type **/P** prompt line: PRINT: FILE, PRINTER, # (OF SLOT)
- 3) Type **P**, or the slot number of the card you wish to send to, and edit line: PRINT: LOWER RIGHT, "SETUP,—, & blank
press **Ⓜ** When you type P, the VisiCalc program looks for the lowest numbered slot containing a printer card or other peripheral communications card, and sends to that slot. If you want to send to a card in a different slot, type the number of the slot.

To determine what coordinate you should enter for LOWER RIGHT, first locate the farthest point to the right that you want to print out. Note its column letter(s). Now find the lowest point on the worksheet that you want to printout. Note the number. The two together give the LOWER RIGHT coordinate that the Print command needs.

- 4) Type in the lower right coordinate (representing both the lowest and rightmost points on the worksheet). Or point to the lower right coordinate with the cursor. prompt line: PRINT: LOWER RIGHT, "SETUP, —, & edit line: The lower right coordinate as you enter it.

At this point, many printer and card combinations are ready to print out the portion of the worksheet you've defined. This is the simplest form of the Print command taking only 5 steps. Other printer/card combinations may have to add a setup string, add a carriage return and/or line feed, or cancel a line feed. Go ahead with step 5 and compare your results to the test printout you ran earlier.

- 5) Press **Ⓜ** The printout should begin. If it doesn't, press **Ⓜ** once more.

Note: you can stop a print out by typing **CTRL C** from the Apple keyboard.

The Setup String

Study the following prompt line:

PRINT: LOWER RIGHT, "SETUP, —, &

LOWER RIGHT was used to give the final coordinates of the rectangle to be printed. The remaining options on this line allow the formatting of the VisiCalc printout.

Many printer/card combinations need the setup string to print in proper format. The setup string is a special command to the printer or interface card and varies with different cards and printers. Setup strings usually begin with escape or a control character and are followed by other characters. **Control and escape characters cannot be entered into the setup string with the CTRL and ESC keys—do not try to use them!**

The VisiCalc program has a special set of characters for entering the setup string. The first character is the carat (^) which is typed by holding down the SHIFT key and pressing N. The following characters may be used in setup strings:

- ^C char Causes the character following to be treated as a control character.
- ^E char Causes the character following to be treated as an escape character.
- ^H nn Produces the single ASCII character character defined by the hexadecimal nn.
- ^R Puts a return character into the setup string.
- ^L Puts a line feed into the setup string.
- ^^ Puts one carat character into the setup string.

Setup strings must be reentered each time a worksheet is printed. When RETURN is pressed, the previous prompt: PRINT: LOWER RIGHT, "SETUP, —, & appears again in the prompt line and these options are again available.

If you were using the Apple Parallel interface card, you may have gotten triple spacing on your printout. Why? Because the VisiCalc program sent a line feed, your card sent a line feed, and your printer sent a line feed—three spaces between each line. To create a single-spaced format, you would go through steps 1 and 2. At step 3, you would do the following:

- a) Type " prompt line: PRINT: SETUP OR RETURN The " signals the VisiCalc program that the next string of characters will be the **SETUP** string.
- b) Press ^CIK ® This is the *CTRL / K* string described on page 17 of the Apple Parallel Interface Card Manual; it eliminates the parallel card line feed.

At this point you could continue with step 4. Or you could put in extra setup strings. For example, the Apple Parallel card allows line lengths of up to 255 characters. If on the first printout test you only printed out a 40-character wide line, you could also enter **^CI80N**® to print out an 80-character line. This is just like the above operation, except you enter **80N** instead of **K** after **^CI**. You'll need to enter your setup strings(s) each time you print out a worksheet.

Any printer that uses the Apple Parallel Interface Card will use the setup string **^CIK** to suppress a line feed. The line length can be set by replacing the number 80 in the string **^CI80N** by any other number your printer will accept.

The Apple Serial card does not need a setup string to modify the format. However, most printers use a setup string to modify the format. For instance, with the NEC Spinwriter 5510 or 5520, you could both indent the entire format and compress the characters in your printout by following these steps after step 3:

- | | | |
|--|--|---------------------------|
| a) Type " | prompt line: | PRINT: SETUP OR
RETURN |
| | To begin the setup string | |
| b) With the print head at the leftmost position, press the NEC space bar 5 times. (Local line feed must be turned on.) | To position the print head for a left margin of 5 spaces. | |
| c) Type ^EM | To set the left margin at the print head position. | |
| d) Type ^E | To begin a second setup string | |
| e) Hold down SHIFT and press M | SHIFT M creates the] character signaling a character spacing command. | |
| f) Release the keys | | |
| g) Type H ® | To set character spacing to 8/120". See your manual for other spacing and command options. | |

Continue with the normal sequence of steps for VisiCalc printout. Most printers that operate with an Apple Serial Interface Card will change format options with similar setup strings. Read the manuals carefully for the setup strings and switch settings you need.

Once you have worked out the settings and instructions that allow you to print out in the format you desire, you should write them down and keep them in your VisiCalc binder for future reference.

Carriage Return and Line Feed

When you ran your first VisiCalc printout, did the print head refuse to return from the right margin? Did the printer try to print everything on one line? Did the printer double space? The VisiCalc program has solutions to these problems that do not involve setups strings. Study this prompt line again.

PRINT: LOWER RIGHT, "SETUP, —, &

The last characters — & let you issue commands to control line feed. Note that when you press one of these characters, no change takes place on the VisiCalc screen. Further, you don't have to press Ⓜ after pressing one of the characters. The VisiCalc program is set to automatically send a line feed with each carriage return.

Note that you can (and sometimes must) use both a setup string and one or more of the carriage return/line feed characters. Let's examine these characters individually.

- Pressing — turns off line feed automatically generated by the VisiCalc program (not the interface card). The VisiCalc program will not send line feeds again until you reboot or until you restore the line feed function with & (see below). The — should only be typed once. If your VisiCalc printout double-spaced, pressing a — before defining LOWER RIGHT will cause all subsequent printouts to single space. Use — with the Centronics card and with the Apple Silentype™ or anywhere you want to suppress an extra line feed.
- & Pressing & restores a line feed with each carriage return. This will remain in effect until you reboot the VisiCalc program or until you type a — (see above).

Printing Out in Sections

If you attempt to print out a row that exceeds the number of characters that your printer can print on a line, you will find part of your line started on the next line of the printout (if carriage return and line feed are in effect). For example, if your printer can only print 40 characters per line, the 41st character will start in the next row down. If you can't extend the length of a print line any further with a setup string, you must print in sections.

To do this go through steps 1 through 3. Then select a LOWER RIGHT coordinate that falls within the width restrictions of your printer. For example with a 40 column printer, you can easily print one window at a time. Assuming that your columns are still set to 9 characters and that the upper left entry position is A1, give the right coordinate as D and then the lowest row position as the remainder of the LOWER RIGHT entry position.

Once you have printed out the A to D section, begin the next print out with your cursor at **E1** for your upper left entry position and **H** as your rightmost column. Continue in this manner until you've printed out the width of your sheet. Unless you're feeding single sheets into your printer, the depth of the sheet shouldn't make any difference. If you are feeding single sheets, then you must restrict your sections vertically as well as horizontally.

Creating a Print Format File

The **/PF** command "prints" your worksheet to a diskette file instead of to a printer. A **PF** or "Print Format" file contains just the data displayed on the worksheet. None of the information about formulas, format, column width, or numeric precision is included. As a result, if you attempt to reload a Print Format file, you will not see it on the screen.

A **PF** file is simply a standard Apple DOS text file. Its characters are exactly what would have been sent to the printer — including carriage returns and line feeds. (In previous versions of the VisiCalc program, the **/PD** command (to print to diskette) performed the functions which are now performed by **/PF**.)

By writing a BASIC, Pascal, or other language program, you can transfer **PF** files into programs such as a word processor. See *The DOS Manual* for information on how to use text files in a program. To create a **PF** file, follow these steps:

- 1) Position cursor at upper left coordinate.
- 2) Type **/P**

prompt line:	PRINT: FILE, PRINTER, #(OF SLOT)
--------------	-------------------------------------
- 3) Type **F**

prompt line:	PRINT: FILE NAME
--------------	------------------
- 4) Type in the file name followed by **®**

edit line:	file name will appear as you type it. Be sure to add .PF or a similar indicator so that you can tell it from an ordinary VisiCalc worksheet file as saved with /SS (see Part III, the Storage Command). Some programs designed to use print format files may require a different file name suffix. Check the documentation for the specific program you want to use.
------------	--
- 5) Enter the LOWER RIGHT coordinate

prompt line:	PRINT: LOWER RIGHT, "SETUP,-, &
edit line:	Coordinates appear as you type them in. You can either type in the LOWER RIGHT coordinate or point to it with the arrow keys.
- 6) Press **®**

The current worksheet will be saved as Print Format file.

The REPEATING LABEL Command

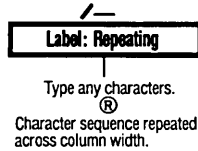

The Repeating Label command lets you draw a horizontal line of characters (such as the dash character, —) for the purpose of visually separating categories of data on the electronic sheet. The Repeating Label command repeats any sequence of characters you enter across the entire width of a column.

If you change the column width (see the GLOBAL Command), the continuous sequence will be modified so that it still fills the column. When you replicate (see the REPLICATE Command) the entry containing the Repeating Label, you can form a line or other visual break across your sheet.

Example

- 1) Position the cursor in the entry position to contain the repeating label.
- 2) Type /—
- 3) Type —
- 4) Press ®
- 5) Use the replicate command to copy the continuous label as far across the sheet as needed.

prompt line: LABEL: REPEATING
 prompt line: LABEL: REPEATING
 edit line: —

The VisiCalc program will extend the sequence across the column. For example, with a general column width (9 characters) you see ----- in the entry position.

Note that in step 3, you can also use combinations of characters such as *#*#. You are not restricted to only one character or to the dash character. The photo below shows two different repeating labels replicated across the screen.

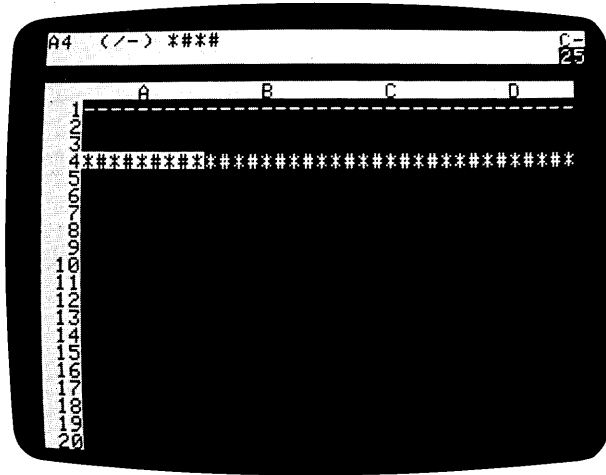

When you save a sheet in the DIF with /S#S, the full repeating labels you see on the screen will not be saved. The DIF will save only the keystrokes that were entered as the label to be repeated.

The REPLICATE Command

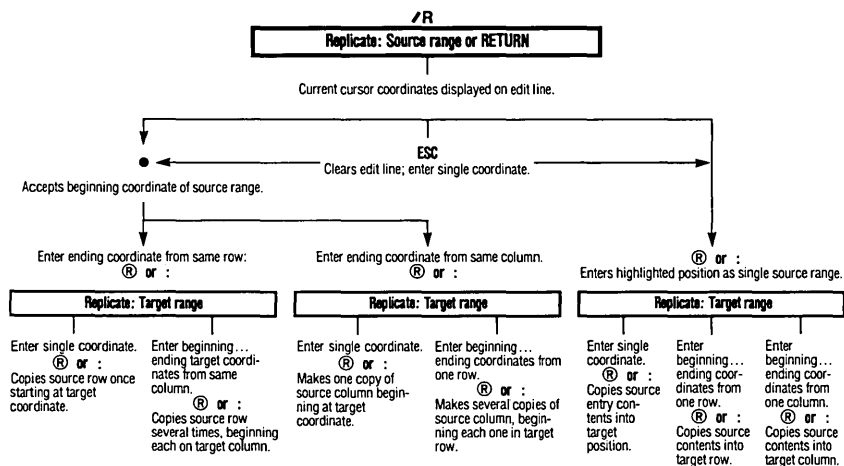

The Replicate command allows you to copy the contents of any entry position, including labels, values (numbers, expressions, and formulas), formats (see Part III, the FORMAT Command), and blank entries (see Part III, the BLANK Command). You may copy a single entry from one place to another, copy a single entry across a row or down a column, or you may reproduce a single row or column as many times as you like.

However, the replicate command does not permit you to copy a row into a column, or to copy a matrix (several rows or columns at once). Complex copying operations can be done with a series of replications or with the /S#S option (see part III, the STORAGE Command). Note, however, that /S#S saves only labels and values, not formulas.

To use the Replicate command, you must supply two (and in the case of value references, three) sets of information:

- 1) The source range
- 2) The target range
- 3) Whether a value reference should be replicated in the same form at all positions or whether it should be made *relative* to each new entry position.

A range may include from one entry position to an entire row or column. Ranges are specified by entering a starting coordinate for the range, a period (as a delimiter), and the ending coordinate. You can enter coordinates by typing them in or by pointing to them with cursor. A range may not cross the sheet diagonally.

The source range tells the VisiCalc program which entry position(s) you want to copy. The target range gives the entry position(s) where the copy

should be made. A complete source and target range specification will appear on the edit line in the following pattern:

```
beginning source coordinate . . . ending source coordinate:
beginning target coordinate . . . ending target coordinate
```

For example, if you wanted to copy the entry at A1 to positions B1 through B10, you would see

```
A1 . . . A1: B1 . . . B10
```

If the beginning and ending **source range** coordinates are identical (F9 . . . F9, for example), only the entry at the coordinate position will be copied in the target range. If the coordinates are different but fall in the same column, you will copy the section of that column defined by the two coordinates (F9 . . . F15, for example). Likewise, if the source coordinates are different and fall in a row, you will copy that section of that row, i.e., F9 . . . L9.

If you want one copy of an entry position, a row, or a column, your target range should contain just one coordinate (F9, for example). If you specify two different coordinates for your target range (F9 . . . F15, for example), the Replicate command will copy your source into each of the entry positions in the target range.

Copying from One Entry Position to Another

To copy from one entry position to another, give one coordinate as the source range and one as the target range.

Example

- | | |
|---------------|--|
| 1) Type /CY | To clear the sheet and place the cursor at A1. |
| 2) Type 100 ® | entry contents line: A1 (V) 100 |
| 3) Type /R | prompt line: REPLICATE: SOURCE
RANGE OR RETURN |
| | edit line: A1 |
| | By starting the command with the cursor on A1, the VisiCalc program automatically entered A1 to begin the source range. |
| 4) Press ® | prompt line: REPLICATE: TARGET
RANGE |
| | edit line: A1 . . . A1: |
| | You have told the VisiCalc program to begin copying the contents from entry position A1 and to end with A1. A1 is the "source range" consisting of one entry position. |
| 5) Type D1 | prompt line: REPLICATE: TARGET
RANGE |
| | edit line: A1 . . . A1: D1 |
| | This identifies entry position D1 as the start of the "target range," the entry position to which the contents of A1 will be copied. |

- 6) Press Ⓜ The replication is completed. The value 100 is now in entry position D1 as well as A1, the highlight is still at A1, and the control panel has been cleared for a new command.

Creating a Column of Entries from One Entry

To create a column by making several copies of one entry, give one coordiante as the source range and two coordinates within a single column as the target range.

Example

Repeat steps 1 through 5 in the example above. Change step 6 to:

- 6) Type .D10 Ⓜ The contents of entry position A1 will appear in entry positions D1 through D10.

You can also replicate formats (see Part III, the FORMAT Command). Note that you must replicate a format *before* entering anything else. If you try to replicate a format into a row or columns that already contain entries, the entries will be replaced by the contents of the source position.

Assume, for instance, that you want a column to display sales figures rounded to two decimal places. Place the cursor on a blank entry position and type F\$ (see Part III, the FORMAT Command) to attach the "dollars and cents" format to the position. Then replicate that entry position using the procedure in the example above.

The entry positions will not change in appearance if there are no values in them at this point. However, when you begin entering numbers into them, they will all be displayed with two decimal places.

Copying a Column from One Position to Another

To copy a column from one position on the sheet to another, give the top and bottom entry position coordinates of the column as the source range. For instance, A1 . . . A32. For the target range, give only the coordinate of the top entry position of the new column. The VisiCalc program will fill in the rest. (Do not give the bottom coordinate for the target range—this will not give you the results you want.) The following example will illustrate how to copy a column and show you how to change a source coordinate from any entry position.

Example

- 1) Type /CY To clear the worksheet and place the cursor at A1.
- 2) Press (S)1 ⬇ 2 ⬇ To set direction indicator to ! and create
3 ⬇ 4 Ⓜ example.
- 3) Type /R prompt line: REPLICATE: SOURCE
edit line: RANGE OR RETURN
A4 followed by the edit cue.
- 4) Press ESC To erase and change the first source coordinate.
- 5) Type A1 edit line A1

- 6) Type .
 - 7) Type **A4**
 - 8) Press **Ⓜ**
 - 9) Type **C4**
 - 10) Press **Ⓜ**
- edit line: A1 . . .
- edit line: A1 . . . A4
- prompt line: REPLICATE: TARGET RANGE
- edit line: A1 . . . A4:
- edit line: A1 . . . A4: C4
- The contents from the source range (A1 to A4) have been put into the target range (C4 to C7) — without typing in the ending coordinate. The cursor has returned to the position it occupied before you typed.

Making Several Copies of a Column

To make several copies of a column, enter the top and bottom coordinates of the source range column and the beginning and ending coordinates of a row as the target range. Each copy of the source column will “begin” in the target row.

Example

Do the example above again, but change steps 9 and 20 as follows.

- 9) Type **A10.D10**
 - 10) Press **Ⓜ**
- edit line: A1 . . . A4: A10 . . D10
- In the target range, A10 will be the top of the first new column and D10 the top of the last column. The target range must be adjacent coordinates in one row or the VisiCalc program will only copy the column once and stop.
- The results will look like those in the photo below.

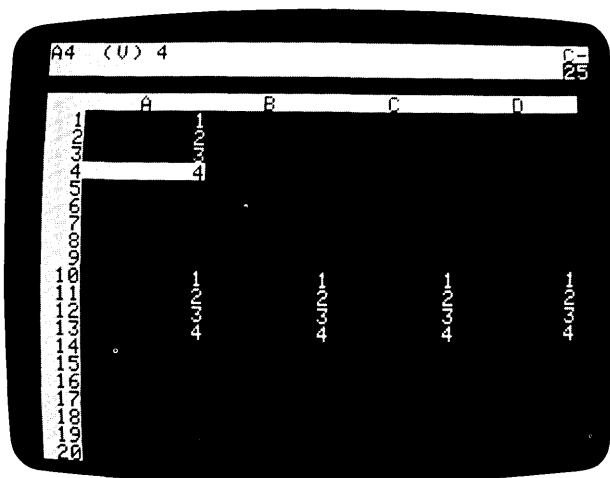

Copying a Row from One Position to Another

To copy a row from one position to another, specify the beginning and ending coordinates in that row as your source range (A . . . C1). Then give the beginning coordinate only for the row in which you want the copy to appear (A5). The VisiCalc program will automatically interpret this target coordinate as the first entry position in a row and will fill in the correct ending position.

Example

- 1) Type /CY To clear the worksheet and place the cursor at A1.
- 2) Type 1 ↵ 2 ↵ 3 ↵ 4 ↵
Ⓜ To set up the example.
- 3) Type >A1 Ⓜ
- 4) Type /R.D1 Ⓜ edit line: A1 . . . D1:
- 5) Type A5 edit line: A1 . . . D1: A5
- 6) Press Ⓜ The result should look like the photo below.

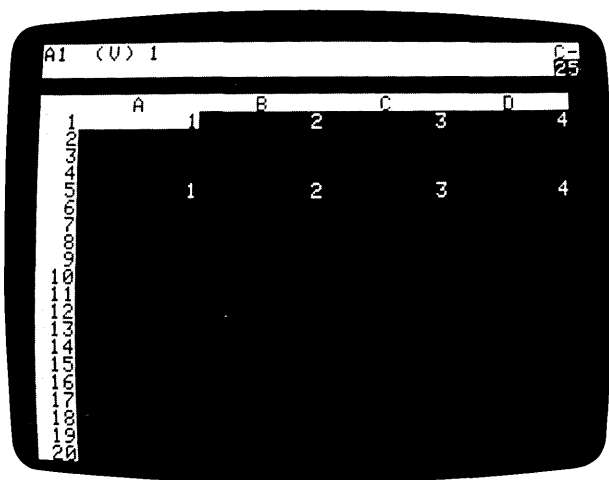

When you give a two coordinate source range and a two coordinate target range, the VisiCalc program makes multiple copies of each entry in the source range. To see this in action, begin again at stop 1. At step 5, type **A5.A10** You should see results like those in the photo below.

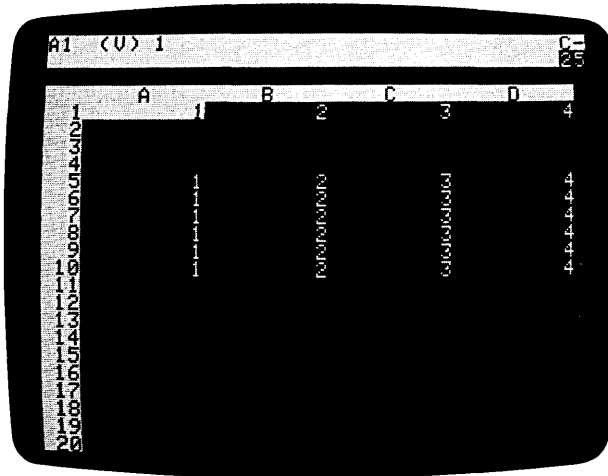

Replicating Value References

The Replicate command treats formulas containing value references (entry position coordinates such as + A1 or + A1+2) differently than it does labels, numbers, and formats. It gives you a choice as to whether you want the value reference copied just as it is (NO CHANGE) or with reference to a preceding entry (RELATIVE).

In formulas containing more than one value reference (+ B1/A1, for example), Replicate offers you this choice for each of the coordinates in the formula. In the next three examples we will first illustrate a NO CHANGE instance of replication, followed by a RELATIVE replication. Finally, we will replicate one element relatively and the other without change.

Example

- | | |
|--|---|
| <p>1) Type /CY</p> <p>2) Type (S)2 ↘ + A1 + 2 ®</p> <p>3) Type /R ®</p> <p>4) Type A3.A6 ®</p> | <p>To clear the sheet and place the cursor at A1.</p> <p>To set direction indicator to ! and create example.</p> <p>prompt line: REPLICATE: TARGET RANGE</p> <p>edit line: A2 . . . A2:</p> <p>prompt line: REPLICATE: N = NO CHANGE, R = RELATIVE</p> <p>edit line: A2: A3 . . . A6: + A1</p> <p>The edit cue over + A1 indicates that + A1 is</p> |
|--|---|

the coordinate that will be copied into positions A3 through A6. The prompt line is asking whether you want it copied *relative* to each position or whether you want it to remain the same in each position. Choose NO CHANGE.

5) Press N

Your sheet will look like the photo below.

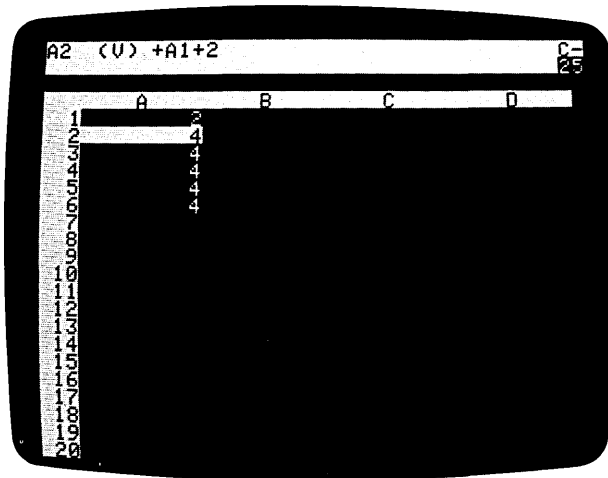

Move the cursor down the column. Notice that each copy of the formula contains the value reference A2 just as it was in the source range. This is the result of choosing NO CHANGE instead of RELATIVE.

Let's make a direct comparison. We'll set up an analogous formula in column B and replicate it relatively.

Example

- | | |
|------------------------|---|
| 1) Type > B1 Ⓜ | To place cursor at B1 |
| 2) Type 2 ⬇ + B1 + 2 Ⓜ | To set up example (direction indicator is still !) |
| 3) Type /R Ⓜ | edit line: B2 . . . B2 |
| 4) Type B3.B6 Ⓜ | edit line: B2: B3 . . . B6 + B1 |
| | prompt line: REPLICATE: N = NO CHANGE, R = RELATIVE |

The edit cue rests on + B1 just as it did on + A1 in the previous example. This time, however, we'll copy + B1 *relative* to each position.

5) Press R

Your screen should look like the one in the photo below.

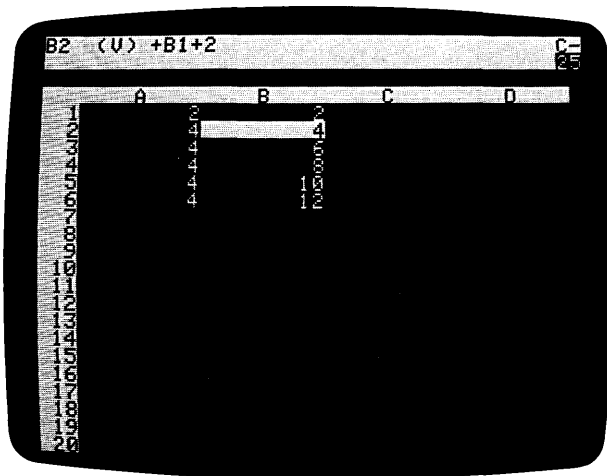

Behind the two different columns of numbers lie two different types of formula. With the direction indicator set to !, use the \blacktriangledown to scroll down column B and notice how the formula changes on each line. Jump over to column A and scroll again, noting how each copy of the formula from A2 remains the same.

We mentioned that in cases where formulas have more than one value reference, the prompt line will ask

REPLICATE: N = NO CHANGE, R = RELATIVE

for each value reference.

Let's see this in action with a third example.

Example

- 1) Type > C1 ®
- 2) Type + B1/A1 ®
- 3) Type /R ®
- 4) Type C2.C6 ®

Place the cursor at C1.

The formula with two value references (B1 and A1).

edit line: C1 ... C1:
 edit line: C1: C2 ... C6 + B1
 prompt line: REPLICATE: N = NO
 CHANGE, R = RELATIVE

The edit cue rests on the first value reference in our formula. Choose RELATIVE.

- 5) Type R

edit line: C1: C2 ... C6: + B1/A1
 prompt line: REPLICATE: N = NO
 CHANGE, R = RELATIVE

The VisiCalc program presents the second

value reference and places the edit cue on it. We'll copy it into each position without changing it.

6) Type N

Your screen should look like the photo below.

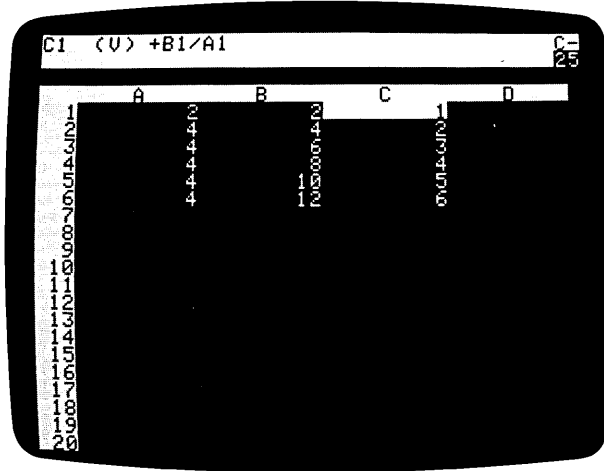

Again, scroll down the column and note how the dividend is a relative figure, while the divisor remains the same. If you wish to experiment further, you can replicate this formula with both dividend and divisor relative and with both unchanged. You can find more examples of the use of the Replicate command in Part II, Lesson Three, of this manual.

It is possible to replicate a formula into a position in which proper relative value references cannot be assigned. If, for example, you were to insert a new column at A (see Part III, the INSERT Command Reference) and replicate the formula at C1 at A1, the relative position of the value references A1 and B1 will be located off the sheet to the left! The way in which the VisiCalc program evaluates such a value reference is undetermined.

Also, you must be careful not to introduce forward or circular references or incorrect calculation order into your sheet when you replicate formulas. These topics are thoroughly discussed in Part II, Lesson Three in the sections entitled "The Order of Recalculation" and "Forward and Circular References," and also in Part III, The VALUE ENTRY Command.

The STORAGE Command

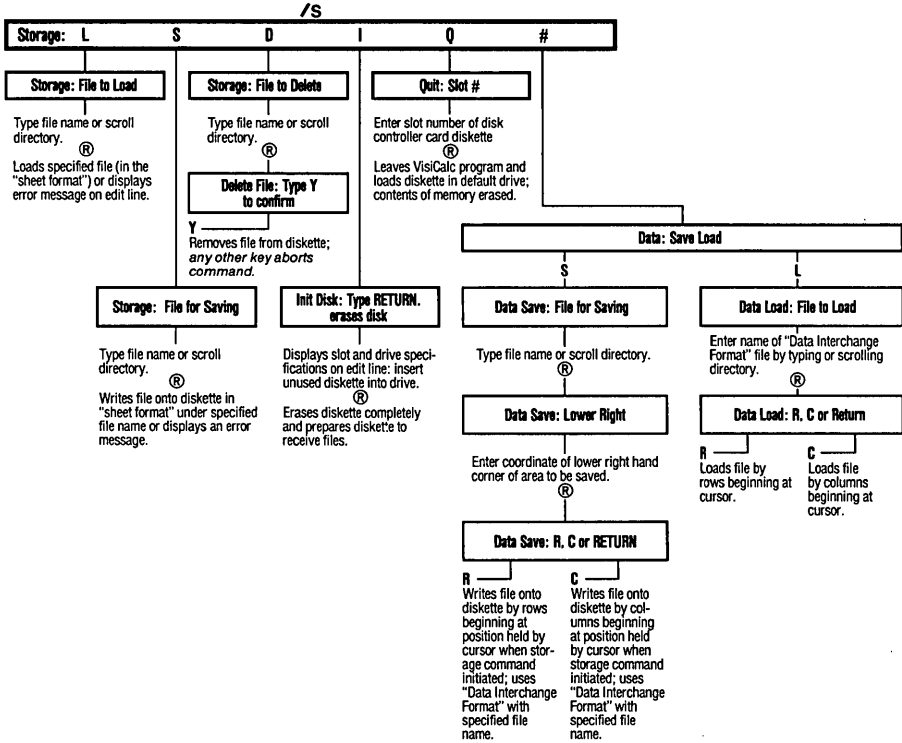

The Storage command lets you save copies of your current VisiCalc worksheet on diskette, load saved worksheets back into the computer, initialize new diskettes for use with the VisiCalc program, and gives you a way to quit the VisiCalc program.

Loading a File from Diskette: The /SL Command

/SL can only load a worksheet back into the computer's memory if the worksheet was saved with the **/SS** command (discussed below). When the file has loaded, the worksheet will appear in the window exactly as it was when you gave the **/SS** command to save it.

If you have a worksheet on the screen when you initiate the Load command, it will not be cleared. Rather, the VisiCalc program will write the worksheet you are loading over the previous worksheet. Wherever an entry position has contents on both the current and the loaded worksheet, the entry position contents of the more recent worksheet will replace the previous contents.

Blank entry positions in the loaded worksheet will not erase the contents of corresponding entry positions in the old worksheet. This over-writing characteristic, called "overlay" gives you the ability to combine worksheets by loading previously saved worksheets over each other.

If you want to work with only the contents of the worksheet you are about to load, be sure to clear the current worksheet from the screen by typing **/CY** (see Part III, the CLEAR Command Reference).

Insert the diskette containing the file to be loaded into the current default drive (usually drive 1) and follow the steps below. If your data diskette is in any other drive than the default drive, you must add a device suffix. The suffix specifies the drive number and, if you are using more than one disk controller interface card, the slot number that controller for the selected drive is in.

The suffix begins with a comma (,) and is followed by the letter **D** and the drive number — either 1 or 2. For example, if you wanted to select drive 2 (assuming that drive 1 is in the default drive), you would type **FILENAME,D2**.

If you are naming a drive connected to a controller card, that is other than the default card, you must first name the slot. Type a comma (,) and the letter **S** with the slot number. For example, to select drive 2 and controller card in slot 5, you would type **FILENAME,S5,D2**. For more information on defaults, and file names, see part II, FILE NAMES. To load a VisiCalc file from diskette, follow these steps:

- | | |
|---|---|
| 1) Type /S | prompt line: STORAGE: L S D I Q # |
| 2) Type L | prompt line: STORAGE: FILE TO LOAD |
| 3) Type the file name
used to save the file
with /SS | edit line: File name as you type it in. |
| 4) Press ® | The VisiCalc program will load the file with the name that was on the edit line. While the file is loading, the prompt STORAGE: LOADING will appear on the prompt line followed by a flashing asterisk. During file loading, temporary ERROR messages may appear. When loading is finished, the worksheet will appear in the window, looking just like it did when you saved it. If ERROR messages remain, your sheet may contain forward or circular references. |

The VisiCalc program offers an alternative to typing in a file name. You can **scroll** file names from the diskette's directory. To scroll file names, press **◆** at step 3. When the file name you want appears on the edit line, press **®** (step 4), and the VisiCalc program will load the file just as if you had typed it in.

The directory scrolling also allows you to edit these file names. When a file name is on the edit line, you may change the name by backing up the edit cue with **ESC** and then typing the characters you wish.

This feature can be useful when, for example, you have forgotten a file name. As you scroll the directory, you may find a file name that causes you to remember the name of the file you want to load. Say the name PROJFEB causes you to remember that the file you want is called PROJAUG.

To change the file name from PROJFEB to PROJAUG, you would press the **ESC** key to back up the edit cue until you've deleted the characters FEB. Type **AUG** and press **Ⓜ**. The VisiCalc program will load PROJAUG.

If you type in or edit to create a file name that is not on the default drive, the message ERROR: NOT FOUND will display on the screen.

If you press **⏏** when the last file name is on the edit line, you will exit the Load command (without an error message). To continue your search, simply remove the diskette you've just checked, insert the next, and begin again with **/SL**.

If you have multiple drives with storage diskettes in them, you can type **/SL** followed by the drive suffix (**,D2** for example) before entering either the file name or pressing **⏏**.

Saving Files on Diskette: The /SS Command

The Save command, **/SS**, will save the contents of a electronic sheet to diskette. All formulas, labels, title settings, explicit and global formats and window settings as well as the position of the cursor, will be saved and in force when the worksheet is loaded. Note that you can only save worksheets on initialized diskettes. See the section below on the Initialization command, **/SI**.

The Save command creates a file for each worksheet saved. You must specify a unique file name for each worksheet file that you save on a particular diskette. This name is called the **file name**.

A valid VisiCalc file name can have a length of 1 to 30 characters. The first character must be a letter. You may compose the rest of the name with letters, numbers, the space character, and all punctuation except the comma (,). No other characters are allowed.

If you wish to save a file to a diskette residing in a drive other than the default drive, you must append a suffix to the file name. See the discussion of suffixes in the Load command section above and in Part III, FILE NAMES, for more information.

The VisiCalc program records the file name along with the address of the file's position on the diskette in the diskette's **directory**. The name and address allow the VisiCalc program to find the file when you issue the Load command.

If you give a file a previously used file name, the newer file will be written over the older one. This is good for updating, but can cause the loss of a great deal of your time and work when you do it unintentionally.

The ability to scroll in file names lets you name files as updates of previous files. For example, you could might modify a file called "SALES5". Instead of writing over "SALES5", you can scroll in the old name, press the **ESC** to erase the "5" and type a "6". The result: an update with the file name "SALES6". And you still have "SALES5" intact.

Though a diskette has enough room to hold many electronic worksheets, it does have limits. Should the disk become full while the VisiCalc program is recording a worksheet into a file, the message **ERROR: DISK FULL** will appear on the edit line.

The VisiCalc program will have saved all that it could under the file name you gave, but not the entire worksheet. If this happens, delete the incomplete file from the full disk (see **/SD** below) and save the worksheet on another, less full, initialized diskette.

To save a file, follow the steps listed below. The cursor may be anywhere on the worksheet when the **/SS** command is started.

- | | | |
|---|--|---|
| 1) Type /S | prompt line: | STORAGE: L S D I Q # |
| 2) Type S | prompt line: | STORAGE: FILE FOR
SAVING |
| 3) Type the file name
(include the drive prefix
if necessary). | prompt line: | STORAGE: FILE FOR
SAVING |
| | edit line: | The file name as you
enter it followed by
the edit cue. |
| or press ↵ | prompt line: | STORAGE: FILE FOR
SAVING |
| edit line: | The file names already on the diskette scroll
into view preceded by the edit cue. When you
find the right file name, you can modify it
with ESC and by typing of new characters. | |
| 4) Press Ⓜ | The status area clears and the drive ac-
tivate, saving the worksheet to diskette
under the file name you specified in step 3. | |

If you try to save a sheet with a file name that is already in the directory, you will see the prompt: **FILE EXISTS: TYPE Y TO DELETE**. If you type **Y**, the old file will be erased. The sheet you are saving will be given the file name on the edit line. Any other key will put you back at the command level with a clear status area.

For information on printing out formulas and formats with the **/SS,S** command, see Part III, the **PRINT** Command.

Deleting Files from a Diskette: The /SD Command

/SD will delete (completely erase) a file from the diskette. After typing **/SD** you must put the name of the file to be deleted on the edit line either by typing it in or scrolling it in.

- | | | |
|---|---|--|
| 1) Type /SD | prompt line: | STORAGE: FILE TO
DELETE |
| 2) Type the file name.
Include the device
suffix, if necessary. | edit line: | File name appears as
you type it, followed
by the edit cue. |
| Or press ↓ | edit line: | The first file name in
the directory appears.
Each subsequent ↓
will cause another file
name to appear until
you have scrolled
through all the names
in the directory. Stop
pressing ↓ when the
name you want is on
the edit line. |
| 3) Press Ⓡ | prompt line: | DELETE FILE: TYPE Y
TO CONFIRM
Any other key will
cancel the command. |
| 4) Type Y | The VisiCalc program will delete the file from
the diskette. | |

Initializing Storage Diskettes: The /SI Command

The Initialization command causes the VisiCalc program to scan the diskette in the default drive and write a series of position indentifiers on it. Any contents on a used diskette will be erased during the process. A diskette must be initialized with **/SI** before using it to save VisiCalc worksheets.

When you load the VisiCalc program to start a session, the VisiCalc program automatically assumes that the diskette to be initialized is located in drive 1 and that the controller card for drive 1 is in slot 6. This is the **default** condition for all Storage commands. If you intend to use drive 2 or if your drive card is in a different slot, you will have to tell the VisiCalc program.

The command to initialize a diskette may be given at any time when the status area is clear. The electronic worksheet currently in the computer's memory will not be affected by the command. The instructions below assume the default drive is 1.

- 1) Insert a blank or other diskette (the contents of which you are willing to erase) into drive 1.
- 2) Type **/SI**

prompt line:	INIT DISK: TYPE RETURN TO ERASE DISK
edit line:	,S6, D1 followed by the edit cue. The default condition is the controller card in Slot 6 and the diskette in Drive 1.
- 3) OPTIONAL
Press **ESC** to erase the drive number and/or slot number. Then type in the correct number(s).
- 4) Press **Ⓜ** Drive activates, initializing the diskette.

Quitting The VisiCalc Program: The /SQ Command

/SQ is the VisiCalc Quit command. **/SQ** causes the VisiCalc program to return default to drive 1 (booting whatever diskette is in drive 1) and erases the current electronic worksheet from memory. The purpose of the Quit command is to allow you to boot up a different program.

Thus, you must place an Apple II program diskette in drive 1 before quitting. If you don't want to start another program, simply remove your diskette(s) from the drive(s) and turn the Apple off.

- 1) Type **/SQ**

prompt line:	QUIT: SLOT #
--------------	--------------
- 2) Type the number of the slot that contains the card for the drive holding the new boot diskette and **Ⓜ** The computer leaves the VisiCalc program and boots your new program.

To begin the VisiCalc program again, place the VisiCalc program diskette in drive 1 and follow the loading steps as outlined in Part I, the Introduction.

The DIF

Files saved with the command **/S#S** are recorded on the diskette in the **DIF** (a data interchange format). This format affords a way for other programs, such as those written in BASIC, to use the data that is on the worksheet. It also provides a way to save and load specific sections of a worksheet. With DIF, you can take information from sections of several VisiCalc worksheets and combine them to make a new one.

The data that was saved in files with the **/S#S** command can be loaded back onto a VisiCalc worksheet with the **/S#L** (load a Data Interchange Format file) command.

Saving Files in the DIF Format: The **/S#S** Command

/S#S saves a rectangular area of the worksheet in the DIF. This command saves labels, blanks, and *calculated* values at full precision in their entry positions on the worksheet. This precision may cause your output to be different from the screen display. If you wish your data to match the screen you must either use the rounding formula (see Making the VisiCalc Program Less Precise later in this section) or save the file with the **/PF** command and then convert to a DIF format with a DIF BASIC program (see The Programmer's Guide to the DIF). The formulas from which the values were derived are not saved (see Part III, the VALUE ENTRY Command for a discussion of formulas and values).

The DIF follows all the file name rules of ordinary VisiCalc file names. However, we recommend that you append the suffix **.DIF** to the file name. Thus, you might rename a VisiCalc file name MYBUDGET to MYBUDGET.DIF.

This suffix allows both the VisiCalc program and you to differentiate DIF files from VC (VisiCalc) files and PRF (Print Report Format) files. Some programs designed to use DIF files will only recognize your file if you add the suffix **.DIF** to the file name. Read your program documentation for information on the interface with the VisiCalc program and DIF files. Some of the VisiCalc program users put **.VC** after VisiCalc files and **.PRF** after Print Report Format files so that they can differentiate between the three file types. See Part III, the PRINT Command for details on Print Report Format files.

The DIF permits data to be read and written in two ways — by row and by column. You can specify to the VisiCalc program which orientation you want by pressing **R** or **C** when prompted. Pressing RETURN is the same as pressing **R**.

For a complete description of the use of the Data Interchange Format, see the "Programmer's Guide to the Data Interchange Format" that comes with this manual. To use the DIF Save command:

- 1) Position the cursor at the upper left coordinate of the rectangular area you want to save.
- 2) Type **/S#** prompt line: DATA: SAVE LOAD
- 3) Type **S** prompt line: DATA SAVE: FILE FOR SAVING
- 4) Type the file name. edit line: The file name appears as you type it, followed by the edit cue.

- Or press **↓** To scroll in the file names already in the directory. Press **↓** until the desired file name appears on the edit line. You may modify by deleting with **ESC** and typing in new characters.
- 5) Press **Ⓜ** prompt line: DATA SAVE: LOWER RIGHT
- 6) Type or point with the cursor to the coordinate in the lower right corner of the rectangle area to be saved.
- 7) Press **Ⓜ** prompt line: DATA SAVE: R, C, OR RETURN
- 8) Press **Ⓜ** The prompt line clears and the drive activates saving the sheet as a DIF file.

Loading a DIF File: The /S#L Command

/S#L will load back the data you saved with the **/S#S** command. Unlike VisiCalc files, which load into the exact positions they were saved at, DIF files can be loaded into any starting position on the worksheet that you want. To load a DIF file, follow the instructions below.

- 1) Place the cursor on the coordinate in the upper left corner of the area to be filled by the file.
- 2) Type **/S#L** prompt line: DATA LOAD: FILE TO LOAD
- 3) Type the DIF file name edit line: The file name as you type it in, followed by the edit cue.
 Or press **↓** edit line: The first file name in the directory scrolls in. If it is not the one you want, continue to press **↓** You may use **ESC** to modify the name.
- 4) Press **Ⓜ** prompt line: DATA LOAD: R, C, OR RETURN
- 5) Press **Ⓜ** or **R** The selected file appears starting at the current cursor position.

If you want to transpose from loading across rows to loading down columns press **C** instead of **R** at step 5. Likewise, a DIF file saved in columnar format can be transposed to row format by typing **R** at this point.

The TITLES Command

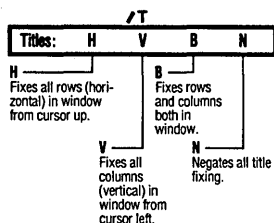

The Titles command allows you to fix rows and columns in place so that they remain in view as you scroll the window over the worksheet.

The position of the cursor at the time you initiate the Titles command determines which column(s) and/or row(s) the VisiCalc program will fix as titles.

/TH, the Horizontal Titles command fixes all rows *at and above* the cursor. Thus if you wanted to fix rows 1 and 2 as titles, you would place the cursor anywhere on line 2. If you wanted to fix only row 1, you would place the cursor on row 1.

/TV, the Vertical Titles command, fixes all columns *at and to the left* of the cursor. Thus, if you wanted to fix columns A and B, you would position the cursor anywhere on B. If you wanted to fix only column A, you would place the cursor on column A.

/TB fixes "Both" row(s) and column(s) at the time. The rows will be fixed *at and above* the cursor and the columns will be fixed *at and to the left* of the cursor. For example, you wanted to fix rows 1 and 2 and column A, you would position the cursor at A2.

/TN negates the Titles command. You can remove titles by typing **/TN** with the cursor at any position on the worksheet.

To create a title, position the cursor according to which row(s) and/or column(s) you want to fix and then type **/T**. The prompt line on status area will display TITLES: H V B N. Then press the appropriate letter for the Titles option you have chosen.

H To fix **Horizontal** titles.

V To fix **Vertical** titles.

B To fix **Both** horizontal and vertical titles.

N **No** titles (to "unfix" titles).

As soon as you type in a Titles option (like **H**), the VisiCalc program executes the command and clears the prompt line. The Titles command causes no immediate change in the worksheet. However, the effect of title fixing becomes apparent when you begin scrolling the window away from the border(s) just fixed.

You cannot use the arrow keys to move the cursor to an entry position that is within a fixed title area. The cursor makes the “thud” noise when it bumps into a fixed title just like it does when it hits a VisiCalc border. Use > to jump the title barrier (see the GO TO Command) and the coordinates of an entry position within the fixed title area; for example, >A1 ®

In certain circumstances, the VisiCalc program will automatically unfix the vertical titles you have set. It does this when, in order to follow your commands, the vertical titles must not be set.

For instance, if you fixed a vertical title with column B at the left edge, and then at some point gave the command to GO TO a coordinate in column A (see the GO TO Command), the VisiCalc program would temporarily unfix the vertical titles. In order to obey the command to go to column A, the window had to be scrolled to the left to bring A into view.

If you have fixed vertical titles, and then you expand the column width (see the GLOBAL Command) so that only one column can be displayed on the screen at one time, the VisiCalc program will automatically “unfix” the vertical title settings. When you return to a narrower column width, you will have to refix the vertical titles.

The VALUE ENTRY Command

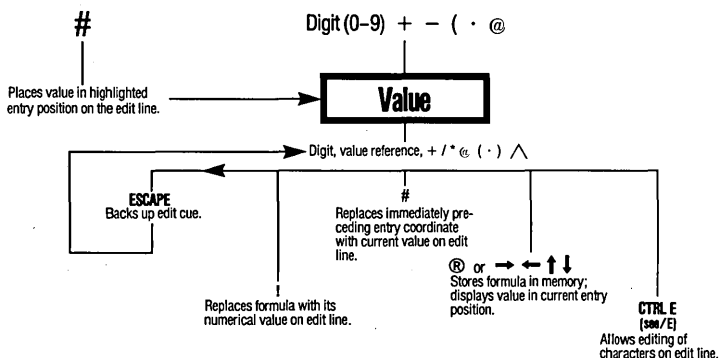

Value entry is the procedure by which you write numbers and formulas on the VisiCalc worksheet. You can enter values in either of two ways:

- 1) By typing the appropriate characters directly at their coordinates and pressing Ⓜ
- 2) By using the arrow keys ((S) ⏏ ⏏) to move the cursor to a coordinate where you have previously placed a value or formula and pressing Ⓜ

Any of the following keystrokes will initiate the value entry command: a digit (0 through 9) + - (. # @

VisiCalc Formulas

By the term "formula", we mean any entry on the worksheet that can be used in a calculation. The following are all formulas.

- 1) Simple numbers like 2, -53, 7.89.
- 2) Numbers written in scientific notation like 1E8 or 5.32E-8.
- 3) Numbers and arithmetical operators such as 3 + 7 24/2*3.
- 4) Single coordinate value references like + B3 or -AB145.
- 5) Combinations of numbers, arithmetical operators, built-in functions, and value references like C5 + 3, (B2-N16)/12, or (@SUM(B2 . . . M2)/N14)*.055

The VisiCalc program has the following arithmetic operators (built-in functions are discussed later in the chapter).

- + addition
- subtraction
- / division
- * multiplication
- ^ exponentiation

As soon as you type one of the characters that initiate a value entry (as listed above), the VisiCalc program immediately places VALUE on the prompt line and displays the character you typed on the edit line preceded by the edit cue. Subsequent characters will also appear on the edit line as you type them.

The presence of the edit cue means that you are free to edit the entry by adding to the formula, using the **ESC** to modify what you've typed, or by pressing **CTRL C** to leave the Value Entry command altogether. The cue will disappear once you press either **Ⓡ** or one of the arrow keys — **⬅** **➡** These keys end the edit mode and enter what you've typed into memory.

Once you've entered a formula, the VisiCalc program displays the formula's calculated value at the coordinates where the cursor rested during entry of the formula. The formula itself will appear on the entry line of the status area when you place the cursor on the entry position where you originated the formula.

For example, if $5 * 12 + 1 - 60$ were the value entry, the entry position would display 1, its calculated value. At the same time, the entire formula would appear on the entry line.

Value References

The VisiCalc program permits you to use entry position coordinates as elements in formulas. These elements, called **value references**, take on the value in the entry position to which they refer. This value will change whenever you change the contents of the reference entry position.

When the first element of a formula is a value reference (a coordinate), you must initiate the value entry command with a **+** or **0+**. If you begin with a letter (the first element of any entry position coordinate), the VisiCalc program would assume you were entering a (non-calculable) Label (see Part III, the LABEL ENTRY Command).

A cursor-moving key (**⬅** or **➡**) will not terminate the Value Entry command, if you type it to point to a value reference that follows an arithmetic operator on the edit line. Rather, pressing an arrow key will simply change the coordinate on the edit line to show the new cursor position.

If the value reference is the last element of the formula, you must press **Ⓡ** to establish it as part of the formula and to enter the formula itself. If you intend to add yet another element beyond the value reference, typing the sign that continues the formula will establish the value reference and allow you to add more elements to the formula.

For example, if $1+$ is on the edit line, and you point with the cursor to A5, the formula on the edit line will be $1+ A5$. Pressing a cursor-moving key at this point will not terminate the command, but will change the coordinate A5 to correspond to the new cursor position. In this example, **Ⓡ** must be used to enter the formula.

However, if the formula you intend to write was $1+ A5 - B5$, pressing **-** after placing the cursor at A5 would establish A5 as a valid element on your formula and would return the cursor to the formula entry position. At this point you would go ahead and point to B5 with the cursor and press **Ⓡ**

If you are looking at different parts of the worksheet through a split screen (see the WINDOW Command), you can use the **;** to jump from one window to the other and point to entry position coordinates you wish to use in the formula.

The VisiCalc program will not allow you to enter an illegal formula such as one which ends with an arithmetic operator. To continue after an illegal entry of this type, you must back up with the **ESC** key to erase the offending character(s). An illegal calculation, such as dividing by zero, will result in a value that is displayed as **ERROR** in the position where the illegal calculation occurs and in all other positions that reference the calculation.

The complexity of a formula, i.e., the number of value references, arithmetic operators, parentheses, functions and their arguments, and the amount of memory in your computer determine the maximum length of the formula you may enter. If the formula becomes too complex as you type it, the VisiCalc program will stop displaying your keystrokes. You will be able to enter everything in the formula up to that point.

VisiCalc Values

The VisiCalc program stores all values in base 10 with either 11 or 12 significant digits. The largest number that the VisiCalc program can accurately calculate is .999999999999E62. The smallest is 9.999999999E-66. When a number is displayed in the general format (see the **FORMAT** Command), the VisiCalc program will shift between conventional and scientific notation as required to display the calculated value with the greatest precision.

In scientific notation, the number 123456789123 becomes 1.235E11. The "E11" means "times 10 to the 11th power." Except in \$ format (see the **FORMAT** Command), non-significant zeros are dropped from the display.

If the column is too narrow to display the number even in scientific notation, the VisiCalc program will place as many "greater than" signs (>) as it can in the entry position. Note that display format (integer, dollars and cents, etc.) and column width do not alter the precision of the number stored in memory. Each value remains as entered for all calculations regardless of how you choose to display it on the worksheet.

Order of Precedence in the VisiCalc Program

The VisiCalc program performs calculations in the order it encounters each operator from left to right. To change the order of precedence, use parentheses to indicate "do this first." If there are parentheses within parentheses, the VisiCalc program will calculate the innermost first. For example, $5 + 6/2*4$ will be evaluated as 22, but $5 + ((6/2)*4)$ will evaluate as 17.

Using the VisiCalc Program as Calculator

The VisiCalc program may also be used as a calculator as you are typing in a formula on the edit line. Suppose you wanted to store the result of $5*12 + 12 + 1 - 60$ as the value entry and not the formula from which it was derived.

Simply type the formula with the cursor at whatever coordinate you choose. You will see the formula on the edit line as you type it in. When you've finished typing in the formula, press the exclamation point ! the VisiCalc program will immediately calculate the value and display the result on the edit line.

To store the result (rather than the coordinate) press **Ⓡ** or an arrow key. From this point, you could also continue developing the formula for the value entry.

Copying a Value without Replication

The VisiCalc program provides a method for duplicating a numerical value from one entry position into another without having either to retype or replicate the formula (see the REPLICATE Command). Note, however, that this method uses only the calculated value in the entry position as the new value entry, *not the original formula*.

To begin, place the cursor at the position into which the number is to be entered, and initiate the Value Entry command with **+**. Then, either point with the cursor or type in the coordinate of the entry position containing the number you wish to duplicate. The edit line will display the coordinate. Press **#**. The *value* of that coordinate will appear on the edit line. Press **Ⓡ** or move the cursor, and the value will be entered into the entry position.

Example

- | | |
|--|---|
| 1) Type ICY | This clears the worksheet and positions cursor at A1. |
| 2) Type 1 | prompt line: VALUE
edit line: 1 |
| 3) Press Ⓡ | entry line: A1 (V) 1
prompt line: clear
edit line: clear |
| 4) Press ↓ | position A1: 1
entry line: B1 |
| 5) Type 3*34 Ⓡ | entry line: B1 (V) 3*34
prompt line: clear
edit line: clear |
| 6) Type ↓ | position B1: 102
entry line: C1 (V) 12 |
| 7) Type > B5 Ⓡ | position B1: 12
entry line: B5 |
| 8) Type + | prompt line: VALUE
edit line: + |
| 9) Press (S) ↓ until
The cursor is
highlighting B1. | edit line: + B1 |
| 10) Press # | edit line: + 102 |
| 11) Press Ⓡ | entry line: B5 (V) 102
prompt line: clear
edit line: clear |
| | position B5: 102 |

If you press **#** immediately after a value reference on the edit line, the value of the coordinate will replace the value reference on the edit line. Pressing **!**

will evaluate the entire formula before it is entered into an entry position, automatically replacing every value reference that is on the edit line with its current value.

Pressing **Ⓡ** or any of the cursor-moving keys after **#** or **!** will enter the value of the formula rather than the formula itself in the entry position. Note that the resulting value will appear in both the highlighted entry position and the entry line. The original formula will not be saved.

Example

- | | |
|--|---|
| 1) Type /CY | This clears the worksheet and positions the cursor at A1. |
| 2) Type (S) 1 ▶ | position A1: 1
The cursor is on A2. |
| 3) Type + | prompt line: VALUE
edit line: + |
| 4) Press ⬇ | edit line: + A1 |
| 5) Type + 1 | edit line: + A1 + 1 |
| 6) Press Ⓡ | entry line: A2 (V) + A1 + 1
position A2: 2 |
| 7) Type ▶ 1 + ⬇ # | edit line: 1 + 2
The value of A2 has replaced the value reference. |
| 8) Type ! | edit line: 3
The formula on the edit line has been evaluated. |
| 9) Press Ⓡ | edit line: A3 (V) 3
position A3: 3
Notice that the formula used to derive the value of 3 has not been stored because of the use of ! . |

In the example above, every time you change the value of A1, you will see the effect of that change in position A2, which contains A1 as a value reference in the formula + A1 + 1. Try it by placing the cursor on A1 and typing **100**. The value in A2 will be recalculated and replaced with the new value, 101.

Recalculation Order

The VisiCalc program formulas may contain as many value references as the complexity of the formula will allow. When any value entry is made, including changing an existing entry, the VisiCalc program automatically recalculates every value on the worksheet. Recalculation always starts in the upper left entry position, A1.

The VisiCalc program is set to calculate column by column. Given a set of values to work on, it calculates a value for A1, then A2, then A3, then A4 to the end of column A. Then it recalculates B1, B2, B3, B4 to the end of column B; then C1, C2, C3, C4, and so on. Note the letter C in the upper right corner of the status area. This indicates that the order of recalculation for the whole worksheet is by column.

The Global command (see the Global command) contains an option which lets you change the order of calculation from down columns to across rows. When row calculation is in effect the upper right corner of the status area will display an R.

Forward and Circular References

Pay particular attention to the placement of any formulas that contain value references. When in the column recalculation mode, be sure that all referenced entry positions are to the left of the formulas that cite them (or above a formula in the same column).

If the worksheet is not arranged in this way, the formula containing a value reference will be recalculated before the new value has been placed in the referenced entry position. When recalculation has been completed, the worksheet will display the value of the formula as calculated using the *old* value from the referenced entry position. However, the *new* value of the referenced entry position will be displayed in the entry position.

This problem, called a **forward reference**, is often difficult to diagnose and might cause you to conclude that the VisiCalc program has made an arithmetic error. If you suspect your worksheet contains a forward reference that is causing a formula to be incorrectly updated, press the ! once. This will force another recalculation of the whole worksheet.

Watch the suspect formula. If a new value appears, look for forward references. You may choose to redesign your worksheet to eliminate all forward references or to use multiple ! for recalculation. In row calculation, referenced values must be placed in the rows above the formulas that cite them (or to the left in the same row).

A common instance of forward referencing occurs in some areas of accounting when column totals are placed at the *top* of the page. Note that if you forward reference a position and recalculate it, the result should be correct. However, if you save and reload the worksheet, the positions containing forward references display ERROR. To see the correct values after reloading the worksheet, you must force another recalculation with !.

A **circular reference** is one that cites itself, such as placing the formula, $1 + A1$, in entry position A1. DO NOT use circular references in a worksheet—their results are unpredictable. To calculate a running total, such as a month-to-date accumulation, study the @SUM function.

The VisiCalc Program's Built-In Functions

Built-in functions are used within value entries to save you the effort of setting up commonly used formulas yourself. Each function begins with @ followed by the "function word," followed by an expression in parentheses (the argument). An argument includes the values (formulas and numbers) upon which the function calculates. For example, the @SUM function might be written:

@SUM (B1, S2, A4*.23)

This expression would result in the sum of the values found in entry positions B1, S2, and .23 times the value in entry position A4. A built-in function may be placed in any entry position by itself or used as part of a larger expression.

The @ may be used as the first character in a value entry (no preceding + is necessary). The function word may be shortened to include only enough letters to avoid confusion with other function words. The function words are listed and defined in the table below with the forms their arguments should take.

Function with Arguments

Each of the functions below is followed by an argument written in parentheses. The arguments shown as *v* may be any legal VisiCalc values.

The arguments shown as *list* may consist of any combination of values and entry ranges separated by commas. The commas serve as delimiters, to separate individual values.

A *range* is a portion of a row or a column specified by its beginning entry position coordinate, three dots, and its final entry position coordinate. An example of a column range is **A3...A17**. An example of a row range is **A3...M3**.

A range may not be a diagonal across rows or columns. When entering a range, you may type in the coordinate or move the cursor to point at the desired entry position. Note that you can insert values into a range (see Part III, the INSERT Command) if you don't insert at the first entry in the range. For example, if you have specified a range of B5 through B10, you cannot insert a row of new material at B5. You can insert at any other position in the range and the formula will automatically expand to include the new material.

Entry positions containing labels or blank entries are evaluated as zeros when they are used as value references in function arguments or in formulas.

@SUM(*list*) adds the values of all entry positions cited in the list.

@MIN(*List*) chooses the smallest value in the list.

@MAX(*list*) chooses the largest value in the list.

@COUNT(*List*) results in the number of non-blank entries in the list.

@ AVERAGE(*list*) @SUM(*list*) divided by @COUNT(*list*).

@ABS(*v*) results in the absolute value of *v*.

@INT(*v*) results in the integer portion of *v*.

@SQRT(*v*) results in the square root of *v*.

@EXP(*v*) returns e (2.71828...) to the *v* power.

@LOG10(*v*) results in the logarithm (base 10) of *v*.

@LN(*v*) returns the natural log (base e) of a number.

@SIN(*v*), @COS(*v*), @TAN(*v*), @ASIN(*v*), @ACOS(*v*), @ATAN(*v*) return the appropriate trigonometric function of the value. Calculations are done in radians.

@NPV(dr, range) calculates the Net Present Value of the cash flows in the range, discounted at the rate specified by dr (the Discount Rate expressed as a decimal). The first entry in the range is the cash flow at the end of the first period, the second entry is the cash flow at the end of the second period.

@CHOOSE (v,list)

Chooses one of a list of values. The first element in the list of arguments is the index to the following arguments. Starting with the second value in the list, **@CHOOSE** counts the index number of elements and returns the value of that element.

For example, in **@CHOOSE** (A4, 10, 20, 30, 40), A4 would be evaluated first. If A4 was 1, the result would be 10, the first number in the following list of arguments. If A4 was 4, the result would be 40.

If the index is zero or less, or if the index is greater than the number of elements in the argument, **@CHOOSE** will return **@NA**.

@LOOKUP (v, range)

Looks up a numeric value in a table and finds the value that corresponds to it. For example, when you do taxes, you look up the gross pay in a tax table and then find the corresponding tax rate.

The table used by the **@LOOKUP** function may be a range within a column or a row. The value that is being looked up will be compared to successive values in that table until a value is found that is larger than the value being looked up (or until the end of the table is reached). The entry in the table that is before this entry is the one that the VisiCalc program will consider as the "match" for the value being looked up.

If the table is in a column, the VisiCalc program returns the value of the entry that is immediately to the right of the "matching" entry as the value of the function. If the table is in a row, the VisiCalc program returns the value immediately below the matching entry as the value of the function. If the first value in the table is greater than the value being looked up, then the value of the function will be **NA**.

An example of the use of the **@LOOKUP** function would be the following invoice form. The total amount of the goods purchased is looked up in a table and the found value is used as a discount percentage. Finally, the dollar amount of the discount is calculated, and the total amount of the invoice is found. In this example, the order of calculation is by row (see Part III, The GLOBAL Command, /GO).

The screenshot shows a Visicalc spreadsheet with the following content:

Formula bar: B7 /FL (U) @LOOKUP(D6,A16...A20)*100 R=17

A	B	C	D
ITEM	PRICE	QUANTITY	TOTAL
B202	15.45	18	278.10
L198	69.42	1	69.42
SUBTOTAL			347.52
% DISCT	10	DISCOUNT	34.75
TOTAL			312.77

LOOKUP AMOUNT	TABLE RATE
0.00	0.00
100.00	0.05
250.00	0.10
500.00	0.20
1000.00	0.25

The formula at entry position B7 is

@LOOKUP (D6, A16 . . . A20)*100

By multiplying by 100, we make it a percentage instead of a decimal. However, we will eventually have to divide by 100 (at D9) to balance out. Although the lookup range is technically a forward reference (see above), it makes no difference in this case because the values in that range are constants.

The formula at D7 is +D6*B7/100. The lookup table has been placed in positions A16 through A20. The entry position at A20 is \$1000.00 referencing a discount of 0.25 at B20.

If the total of the invoiced items was \$347.52, then the discount percent would be 10% (the value that corresponds to \$250.00). A total of \$3000.00 would have a discount of 25%, the same as for \$1000.00.

Note that the recalculation indicator is set to R for recalculation by row. This has nothing to do with the fact that we are performing a lookup. Rather, recalculation must be done by row because the "price times quantity" calculations are by row, not column. The left-justified format (indicated by /FL has been used for purposes of readability (see Part III, the FORMAT Command).

Functions without Arguments

@PI is the ratio of the circumference of a circle to its diameter. The VisiCalc program evaluates **@PI** as 3.1415926536.

@NA (Not Available) is used when a worksheet must be set up before the data to be evaluated is available. If entry positions that will later contain data are left blank, they will be evaluated as zero if used as value references in formulas. This will produce the entry **ERROR** on the worksheet wherever zeros appear as denominators and may produce incorrect or misleading values elsewhere.

Entering **@NA** into the blank data positions causes the VisiCalc program to evaluate all entries that refer to those positions as **NA**. Without entering the data, you can be assured that all your formulas are legal in the VisiCalc program.

Any illegal calculations will show up as **ERROR**. Like **@NA**, **@ERROR** is also displayed in the entry position into which it is entered and all positions that refer to it. In addition, the **@ERROR** function is often generated by the VisiCalc program in such cases as when a deleted row or column contained entry positions that are value references in formulas.

An **ERROR** message will also result from a too deep nesting of (or of + . Expression syntax errors can also generate an **ERROR** message. Note: it's okay to save worksheets that include either **ERROR** or **NA** entries.

@TRUE and **@FALSE** are used with the Boolean functions listed below. They will produce the entry **TRUE** or **FALSE** in the positions where they are entered. The entries **TRUE** and **FALSE** will also appear when the comparison operators (<, >, =, <=, >=, and <>) are used.

Logic Functions

A logical value is one that evaluates as either true or false. A logic function is one that manipulates true and false values. They are similar to mathematical operations but operate only on this special set of values.

The comparison operators work on two numeric values and return a logical value. When these operations are stated in English, the comparisons become clearer. For example, $4 > 1$ can be stated in English as "four is greater than one." Since this is a true statement, the result would be the logical value **TRUE**. The statement $5 = 3$ (five equals three) is a false statement, and the result of this entry would be **FALSE**.

These comparisons can be used as entries at specific coordinates on the worksheet, or as arguments in a logic function. If they are used as entries on the worksheet, caution must be taken not to include them in a range that will be referenced by a built-in function that does not use logic functions. If this happens, **ERROR** will be returned.

The comparison operators are:

Greater Than: value 1 >	results in TRUE if value1 is larger than value2
value 2	FALSE if it is not.

Less Than: value1 < value2	results in TRUE if value1 is smaller than value2, FALSE if it is not.
Equal To: value1 = value2	results in TRUE if value1 equals value2, FALSE if it is not.
Less Than or Equal To: value1 < = value2	results in TRUE if value1 is smaller than or equal to value2, FALSE if it is not.
Greater Than or Equal To: value1 > = value2	results in TRUE if value1 is larger than or equal to value2, FALSE if it is not.
Not Equal To: value1 < > value2	results in TRUE if value1 is not equal to value2, FALSE if it is equal.

@NOT takes a single logical value as its argument (ie, one that evaluates to TRUE or FALSE) and returns the other logical value. In the simplest form @NOT(A1) will return FALSE if A1 is TRUE, and TRUE if A1 is FALSE. If A1 evaluates to NA, @NOT(A1) will return NA, @NOT (value) where the value is anything other than TRUE, FALSE, or NA, will evaluate to ERROR.

@AND takes any number of arguments, each of which must be a logical value or a range of logical values. It returns TRUE if all the arguments are TRUE, and FALSE if any of the arguments is FALSE. If any of the arguments is not a logical value or evaluates to ERROR then ERROR will result. If any of the values is NA, and all other values are TRUE or FALSE, NA will result.

@OR takes any number of arguments, each of which must be a logical value or a range of logical values. It returns TRUE if any of its values is TRUE and FALSE if all of its values are FALSE. If any of the arguments is not a logical value or evaluates to ERROR then ERROR will result. If any of the values is NA, and all other values are TRUE or FALSE, NA will result.

@IF takes three arguments. The first must be a logical value. The second and third may be any value. If the first value evaluates to TRUE, @IF returns the value of the second argument. If the first value evaluates to FALSE, @IF returns the value of the third argument. If the first argument is NA, NA will be returned. If the first value is not a logical value or NA, ERROR will be returned.

For example, @IF(D5, 2, 3) would return 2 if D5 evaluated to TRUE and 3 if D5 evaluated to FALSE. @IF(D5, E1, E2) would return the value of E1 if D5 evaluated to TRUE and the value of E2 if D5 evaluated to FALSE.

@ISNA takes one argument which may be anything. It returns TRUE if the value of the argument is NA and FALSE if the value of the argument is anything else.

@ISERROR takes one argument which may be anything. It returns TRUE if the value of the argument is ERROR and FALSE if the value of the argument is anything else.

@ISNA and @ISERROR allow you to manipulate entries you have specifically designated NA or ERROR and return a value that is not automatically designated NA or ERROR.

Making the VisiCalc Program Less Precise

Because the VisiCalc program calculates and rounds to 11 (and sometimes 12) decimal places, differences of pennies and even dollars can occur between VisiCalc results and those produced by ordinary 2-place precision calculations. This difference can cause problems when attempting to balance books and during audits.

To solve this problem, you can use a *rounding formula* that will reference your original formula and reduce its calculating precision to just two decimal places. The formula is:

$(@INT((coord) * 100 + .5))/100$

where *coord* is the entry position coordinate of the original formula. The problem and its solution are illustrated below. Basically, we have twelve notes worth \$509.67 each. The interest paid on those notes is 14.66%. What will the value of the twelve notes be after one year?

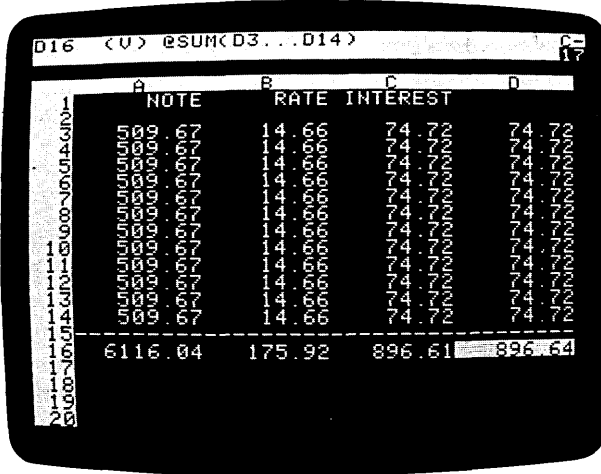

Column C shows the amount multiplied by the interest in the VisiCalc "dollar" format (see Part III, the FORMAT Command) — the format most used by accountants and bookkeepers. The value that VisiCalc adds twelve times is 74.717622, rounded for display purposes to 74.72.

However, if you were to take the dollar format amount (74.72) and multiply it by 12, you'd get the column D result — 896.64. That's a difference of 3 cents that an ordinary calculator (or pencil and paper) would show over the VisiCalc program's sum at C16.

To get the less precise “calculator answer”, we used entry position C3 as *coord* in the rounding formula. The formula at C3 is $+ A3*B3/100$. Thus, the rounding formula at D3 is

(@INT((C3)*100 + .5))/100

After entering the formula, it's a simple matter to replicate position D3 to the range D4 to D14. To conclude we entered the **@SUM** function for the range D3 to D14. The sum at D16 is the one that will balance the books because the rounding formula has held its precision to just two decimal places.

The VERSION Command

/V

© 1980 Software Arts, Inc. x.xx

Displays copyright notice and version number on prompt line; clears automatically with next keystroke.

To see the copyright notice and the version number of your VisiCalc program, type **/V** when the status area is clear. You may use this command anytime, without disturbing the contents of a sheet you may have loaded. As soon as you press any key, the notice will disappear from the status area.

Should you need to call or write with questions about the VisiCalc program, be sure to include the version number that appears when you give the version command. The photograph illustrates how the notice appears on the screen. Your version number will follow the copyright notice on the prompt line. Your program diskette serial number will be displayed on the edit line.

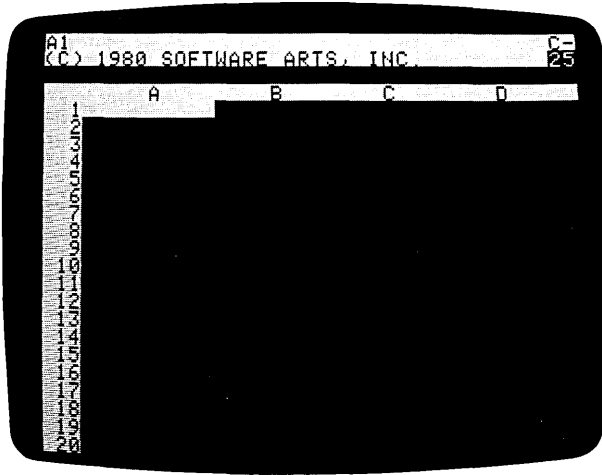

The VisiCalc Screen

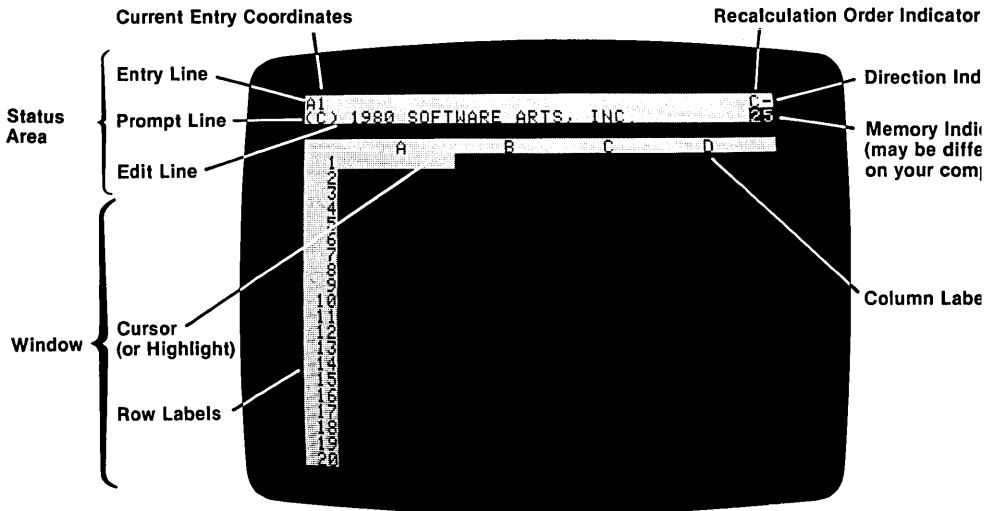

The VisiCalc screen comprises the status area at the top, the column and row borders, and the window area through which you view the electronic worksheet. The status area includes the top three lines of the VisiCalc screen. These lines are (from the top downward)

- 1) The **entry line**
- 2) The **prompt line**
- 3) The **edit line**

Note that the entry and prompt lines share the wide light bar at the top; the edit line is the dark line just above the column border.

The **entry line** (the top line of the panel) displays the *contents* of whatever coordinate the cursor rests on. It can display as many as six items of information about an entry position. These are:

- 1) The cursor coordinate
- 2) The explicit format (if any)
- 3) The entry type symbol (**L** or **V**)
- 4) The precise entry (if any)
- 5) The recalculation order indicator
- 6) The (cursor) direction indicator

The first item on the line is the coordinate on which the cursor currently rests. It is always displayed.

The VisiCalc program reserves the second position on the entry line for any explicit formats (see Part III, the **FORMAT** Command reference) set at the coordinate.

The third item is the entry type symbol. If you have made an entry at the cursor position it will display either (L) for Label (see Part III, the LABEL ENTRY Command) or (V) (see Part III, the VALUE ENTRY Command).

The fourth item displayed is the exact content (as it was entered) at the entry position. If nothing has been entered at a particular coordinate, this space remains blank.

The fifth item is the recalculation order indicator, either an **R** for Row recalculation or a **C** for Column recalculation. The recalculation indicator will blink during recalculation. Unless you reset the calculation mode, the **C** will be displayed (see Part III, the GLOBAL Command for more information on calculation and recalculation).

The sixth item is the direction indicator. Pressing the space bar, designated with the symbol (S), sets it to ! for vertical cursor motion or to - for horizontal cursor motion.

The **prompt line** is the middle line in the control panel. It displays the two pieces of information:

- 1) The current command prompt
- 2) The memory indicator

The command prompt displays the options that the VisiCalc program offers you at any given point in a particular command sequence. To see how one prompt leads to another, turn to the Command Structure Chart at the beginning of Part III. Each individual command in the Reference section also has its own chart.

The prompt line is said to be "clear" when only the memory indicator is displayed. You cannot begin a new command unless the prompt line is clear. Pressing **CTRL C** will cancel any command and clear its prompt.

The **memory indicator** on the right of the prompt line constantly displays the amount of memory available.

The **edit line** is the bottom line of the status area. It displays each character as you type or point to it with the cursor. An edit cue (a small white block) always appears after the last valid character entered.

Characters that are displayed on the edit line can be edited by erasing them with the **ESC** key (see below) and then retyping, if desired. The VisiCalc program will also, on occasion, use this line to display information that it wants you to confirm or clarify before it carries out a command.

The Window and Worksheet

The VisiCalc **window** is that portion of your screen surrounded by the column border above and the row border to the left. You view particular areas of the worksheet by scrolling the window with the arrow keys.

The column border divides the worksheet into 63 columns, labeled A through BK. The row border extends down the left side of the screen and labels worksheet rows from 1 to 254.

Entry Positions

The intersection of each column and row defines an **entry position**. A column letter followed by a row number identifies each entry position, i.e., D17. This identifier is called the entry position **coordinate**.



The Cursor





Each time you load the VisiCalc program or use the **/CY** command (see Part III, the **CLEAR** Command), a column-wide rectangle covers the entry position at A1. This rectangle is called the **cursor** and sometimes the "highlight".

The cursor is used to identify entry positions for typing in data (labels, numbers, and formulas) and for identifying the position at which a particular command should be executed.

The VisiCalc program displays the current cursor coordinated at the left side of the entry line until the command is completed and the cursor moved. During the course of some commands, however, the cursor can be moved by using the arrow keys (an action called **pointing**).

Moving the Cursor



The two arrow keys ( and ) let you move the cursor to any position on the worksheet. Pressing the space bar (symbolized by (S)) changes the cursor direction between horizontal motion and vertical motion. The current direction is displayed by the direction indicator at the right corner of the entry line.

When the direction indicator is set to **!**, the  moves the cursor upward and the  moves it downward. When the direction indicator is set to **-**, the  moves the cursor left and the  moves the cursor to the right. Pressing an arrow key will cause the cursor to move one entry position at a time. See Part I, the Introduction, "Some Notes on Your Keyboard" for a detailed discussion of the arrow keys.

When the cursor has been moved to the right or bottom edge of the window (the portion of the worksheet seen on the screen), the VisiCalc program will follow the cursor by **scrolling** the window across or down the worksheet. Scrolling keeps the cursor in view at all times. If you scroll the cursor into any of the four edges of the electronic worksheet, the cursor will flash and the Apple II will make the "thud" noise.

To jump directly from one coordinate to another, you can use the **GOTO** command (**>**) instead of scrolling. See Part III, the **GOTO** Command, for details.

The Repeat Key (REPT)

To cause any key to repeat its function, *first* press the **REPT** key *then* the key to be repeated. Use of the **REPT** key with  or  will cause the cursor to move more quickly in the direction of the arrow without extra key strokes. The window will scroll to keep up with the cursor. **REPT** can be used with **ESC** to quickly edit instructions on the edit line.

Pointing with the Cursor

Whenever a command allows you to type in a formula (see Part III, the VALUE ENTRY Command) or an entry position coordinate, you can enter that coordinate by **pointing** to it with the cursor.

Check the prompt and edit lines to be sure you have begun the command and that the VisiCalc program is waiting for you to enter a coordinate before you press one of the cursor-moving keys. Then move the cursor to the desired entry position. You will see the coordinate on the edit line change as you move the cursor. If you try to point with the cursor when it is not allowed, the VisiCalc program may end the command and move the cursor to the next entry position.

Typeahead

At times, you may type faster than the VisiCalc program reacts to your keystrokes. This is because the VisiCalc program may be doing any number of things in reaction to the last key you pressed, such as expanding the electronic worksheet and recalculating formulas. The VisiCalc program has a feature called **typeahead**. Typeahead remembers which keys you pressed no matter how fast you go. It will catch up with you as soon as it can.

Correcting Mistakes

When you have characters on the edit line, you may back up to erase them by pressing the **ESC** key and then typing in the correct characters. Each time **ESC** is pressed, the edit cue on the edit line will erase one character. If you press it one more time than you have characters on the edit line, VisiCalc will automatically cancel the command and leave you with a clear status area.

You can also make changes in characters on the edit line by using the Edit command (/E). The Edit command can be used to change entries that have already been entered into the VisiCalc worksheet. (See Part III, the Edit Command).

To change the contents of an entry position, you can also move the cursor to the coordinate and type in the new contents. When you finish the command with its appropriate terminator (such as **®**), the old contents will be replaced by the new. Note that the entry line continues to display the old data while the edit line shows the new data as you type.

If you start a command and decide you don't want to complete it, press **CTRL C** by holding down **CTRL** *while* pressing **C** to cancel the command and return to a clear status area.

The Memory Indicator

The number at the right side of the prompt line is the **memory indicator**. It tells you how much memory is available as you write on the electronic worksheet. If you see the letter **M** displayed in this spot, it means you have used up all the Apple's memory. See the discussion of the computer's memory and the way the VisiCalc program uses it in Part II, Lesson Two, entitled "Postscript: Memory and the Electronic Sheet".

The WINDOW Command

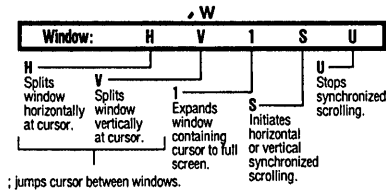

The Window command (/W) splits your screen vertically or horizontally at the cursor position so that you can view the worksheet through two windows simultaneously. Thus, you can compare rows or columns that are too far apart on your worksheet to be viewed through the single window. Once you have split your screen, you can scroll either window independently of the other or scroll them together.

The Window command also allows you to set different global formats in each window and to look at the same entry position in two different formats (see Part III, the GLOBAL Command).

The Horizontal Window Command: /WH

/WH splits the window in two by placing a second column border (A, B, C, D, . . .) just above the row containing the cursor. When the command is executed, the cursor will move up one row into the upper window. For example, typing /WH when the cursor is at entry position A4 will place the horizontal border *between* A4 and A3 and will place the cursor at A3.

Because the /W command places the column bar *between* two rows and because it pushes the cursor upward, it will not work if the cursor is positioned in row 1 — there's no "between" and no place to put the cursor. The following example will illustrate both the horizontal and vertical window commands.

Example

- 1) Type /CY This clears the screen and positions the cursor at A1.
- 2) Type \blacktriangleright 2 \blacktriangleright 3
4 $\text{\textcircled{R}}$
- 3) Type > A1 $\text{\textcircled{R}}$ (S)

- 4) Type ONE ↵
- TWO ↵
- THREE ↵
- FOUR ↵
- 5) Type >C3 Ⓜ

Your screen should look like this:

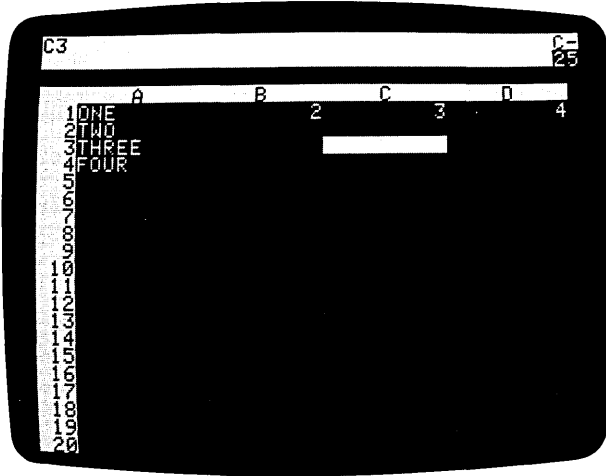

- 6) Type /W
- 7) Type H

prompt line: WINDOW: H V 1 S U
 Your screen will look like the photo below.
 Note the position of the cursor and the horizontal bar.

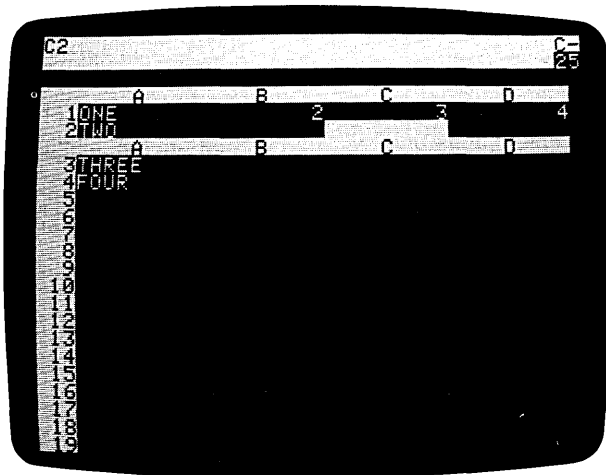

Each window will now view the worksheet independently. The cursor can move around the worksheet in the top window. Move the cursor to position A1 to highlight ONE in the top window. Press ; to jump the cursor to entry position C3 the bottom window.

Pressing ; will always make the cursor jump to the last position it had in the other window. In this case, that position was C3. Press ; once more. The cursor returns to A1, the last entry position it rested on before it jumped to the lower window.

All VisiCalc commands will work in both windows and you can see the effects on the worksheet through either window. The two exceptions are the /GC (Global Column) and /GF (Global Format) commands, which are set in one window at a time (see the GLOBAL Command).

Jump to the bottom window with ; and remove the horizontal window by typing /W1. The window containing the cursor will then occupy the whole screen using the current format settings of that window. A horizontal window must be removed before a vertical window can be instated and vice versa. The size of each window is determined by the position of the cursor at the time the window command is used. If you wish to do the example for /WV, type >A1 ® to bring the example back into view.

The Vertical Window Command: /WV

/WV splits the window by adding a second row border (1 2 3 4 5 . . .) just to the left of the column containing the cursor. Thus, if you positioned your cursor at B3, the second row border would appear between A3 and B3 and push the cursor into the left window at A3.

When the screen has been split vertically, the columns in the right window may be slightly narrower than those in the left window. This is to make room for the second row border. As a rule, the VisiCalc program will narrow a right window by a space if the narrowing will preserve a column on the screen.

The vertical window behaves like the horizontal window described above. Note that when you return to one window, the format settings of the window in which the cursor is located go into effect in the single window. The column width of the right window, which was automatically narrowed, will also be in effect if the cursor is in that window when /W1 is typed.

If you do not have the previous example on your screen, type in steps 1 through 4 before continuing.

Example

- 6) Type > B3 Ⓜ
- 7) Type /W
- 8) Type V

prompt line: WINDOW: H V 1 S U
 Your screen should resemble the photo below. Note the position for the border and the cursor

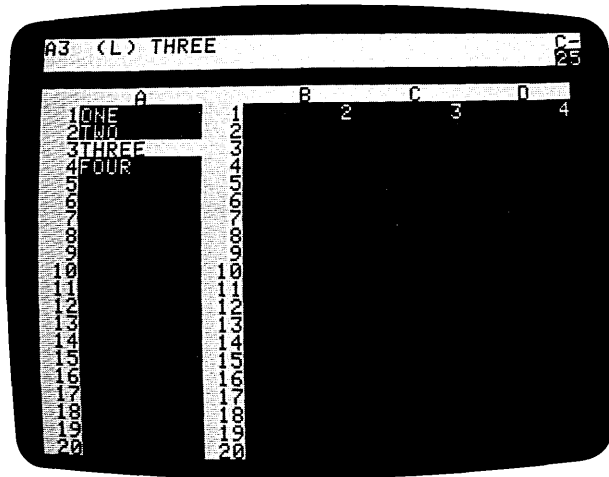

The vertical window can be particularly useful when you wish to keep a column of information visible in one window while you scroll the other window around to compare columns in different places on the worksheet.

The One Window Command: /W1

/W1 (One Window) displays the window (with its global format settings in effect) the cursor was in when you executed the command. The global format settings are put into effect across the entire worksheet.

The Synchronized Window Scrolling Command: /WS

/WS (Window Synchronized) synchronizes horizontal motion in horizontal windows or vertical motion in vertical windows so that scrolling the window that contains the cursor causes the other window to scroll too.

The Unsynchronized Window Scrolling Command: /WU

/WU (Window Unsynchronized) turns off synchronized scrolling. The last three window command options (/W1, /WS, and /WU) may only be used after a /WH or /WV is in effect.

APPENDIX A:

USING DOS 3.3 WITH VISICALC FILES

The VisiCalc program creates BASIC text files when it saves worksheets on a diskette. DOS commands and programs that handle BASIC text files can be used to manipulate VisiCalc data files. This appendix lists the DOS features which can be used with VisiCalc files and what limitations there are to their use. The programs listed are on the DOS 3.3 SYSTEM MASTER diskette that comes with the Apple II. Except where limitations are given, the commands and programs will operate as they are described in *The DOS Manual*.

DOS 3.3 COMMANDS

The DOS commands DELETE, RENAME, VERIFY, and CATALOG may be used with VisiCalc files. The LOCK command may also be used on a VisiCalc file, but the file must be UNLOCKed again before the VisiCalc program will be able to use it.

INIT

The DOS Manual explains how to initialize new diskettes by writing a greeting program and using the INIT program. This program allocates space on the diskette for DOS when writing the greeting program. Diskettes initialized in this manner may be used as VisiCalc storage diskettes.

In order to provide extra storage space on data diskettes, the VisiCalc program does not allocate space for DOS when it initializes diskettes with the /SI command. If diskettes are only to be used as VisiCalc data diskettes, the extra storage space provided when initializing with /SI is desirable. However, if the diskettes are to be used with other programs, in particular the MASTER CREATE program, the diskette must be initialized with the DOS INIT program.

MASTER CREATE

Diskettes initialized with the /SI command cannot be used with the DOS 3.3 MASTER CREATE program. If DOS is put on a /SI initialized diskette with the MASTER CREATE program, any files on that diskette will be lost.

A diskette initialized with the BASIC INIT program can be used with the MASTER CREATE program without losing files. Whenever MASTER CREATE is to be used on a VisiCalc storage diskette, make sure the diskette was initialized with the BASIC INIT program, not /SI. The INIT greeting program (usually HELLO) will be the first program listed when the CATALOG command is given.

COPY

Backup copies of entire diskettes can be made with the COPY program described in *The DOS Manual*. The VisiCalc program diskette is copy protected and cannot be copied, but all storage diskettes should be copied to insure against accidental loss of data.

FID

The FID program, described in Appendix J of *The DOS Manual*, will copy a single file from one diskette to another. It also performs DOS commands (CATALOG, DELETE, LOCK, UNLOCK, AND VERIFY) which are subject to the same limitations already discussed. It also has a special command to let you find out how many sectors are used and unused on a diskette.

MUFFIN

Data disks created with the 13-sector version of the VisiCalc program can be rewritten for use by the 16-sector version with the MUFFIN program. Simply follow the directions in Appendix K of *The DOS Manual*. The 16-sector destination diskette can be initialized either with the BASIC INIT program or the VisiCalc /SI command.

The only limitations on converting 13-sector VisiCalc files to 16-sector VisiCalc files are in worksheet size. The 13-sector version of the VisiCalc program allows a larger worksheet size than can be used with the 16-sector version. With a 48K Apple, the worksheet cannot exceed 18K of memory. With a 64K Apple, the worksheet cannot exceed 34K of memory. If the 13-sector worksheet is larger than this, some information will have to be deleted and the sheet shrunk before it can be converted and used by the 16-sector VisiCalc program.

APPENDIX B:

EXCHANGING FILES

The DIF™ format is a standard file format that allows unrelated programs to share data.

- Within the VisiCalc program, you may use it to manipulate sections of the worksheet and to transfer sections of one worksheet to another. This allows data consolidation for purposes such as corporate or annual calculations. You can use the DIF format this way, regardless of previous computer experience.
- Outside of the VisiCalc program, it saves data in text files that can be read by other DIF-supporting programs. Thus, a file created by the VisiCalc program can be saved and read by other programs that support DIF. Files created with these other programs can be loaded by the VisiCalc program. These programs can be written (in BASIC, for example) so that data generated by the VisiCalc program can be integrated into a broader set of personal computing tools. Use of the DIF format in this way is recommended for experienced programmers only.

This appendix describes the VisiCalc commands that save and load DIF files and how the files can be used within the VisiCalc program. It then describes the format itself and lists three sample programs in BASIC that read and write DIF files.

Additional information about DIF™ is available through the DIF Clearinghouse. The DIF Clearinghouse is set up to:

- Coordinate and distribute information about DIF format.
- Maintain and distribute DIF Technical Specification.

Information about the DIF Clearinghouse can be obtained by writing to:

**DIF Clearinghouse
P.O. Box 527
Cambridge, MA 02139**

DIF™ is a trademark of Software Arts, Inc.

The Save DIF™ Option—/S#S

The Save DIF option of the Storage command (/S#S) saves the worksheet in the DIF format. It is recommended that you add .DIF to the file name so it can be recognized later as a worksheet saved as a DIF file.

The VisiCalc DIF option saves and loads a worksheet in one of two ways—by row or by column. The VisiCalc program prompts you to specify the orientation by typing **R** or **RETURN** or **C**. **R** or **RETURN** save worksheets by rows; **C** saves by columns. Specify **R** or press **RETURN** when saving a worksheet to be loaded later by the VisiCalc program.

When a worksheet is saved in the DIF format, all formulas are converted to their resultant values. Repeating labels are converted to the initial label without repetitions.

Load DIF™ Option—/S#L

The Load DIF option of the Storage command (/S#L) loads a worksheet stored on a diskette in the DIF format. The file can be one saved with the Save DIF option of the Storage command, or created by another program.

Unlike a worksheet saved in the normal fashion—which is loaded into the same position it occupied when it was saved—the upper left corner of a worksheet loaded in the DIF format is the position of the cursor when the Storage command is typed.

As with the other options of the Storage command, you can display the names of the files on the diskette by typing → in response to the File to load: prompt.

The VisiCalc DIF option loads a worksheet in one of two ways—by row or by column. The VisiCalc program prompts you to specify the orientation by typing **R** or **RETURN** or **C**.

Using the DIF™ Format within the VisiCalc Program

The DIF format can be used to save rectangular portions of the worksheet and load them back in another place on the same or a different worksheet. The cursor position indicates the upper left coordinate of the portion to be saved. You are prompted to enter the lower right coordinate. When you reload the file, the upper left corner of the saved portion is placed at the current cursor position.

Saving files in the DIF format converts all formulas to values. If you have a section of a worksheet containing formulas and wish to convert the formulas to values, save that section in the DIF format with a new file name and reload it again in the same place on the worksheet. All repeating labels will be converted to the initial labels without repetitions.

The DIF format allows transposing of rows and columns. A worksheet or section of a worksheet might be saved in the DIF format with R or RETURN to specify row orientation. When the worksheet is loaded, column orientation can be specified. The rows will then be displayed as columns and the columns as rows. Likewise, data may be saved by columns and loaded in rows.

For example, this file,

```
A1 B1 C1
A2 B2 C2
A3 B3 C3
```

is saved by rows in the DIF format with A1 as the upper left coordinate and C3 given as the lower right coordinate. When the file is loaded with the cursor at A1, column orientation is specified. The result is:

```
A1 A2 A3
B1 B2 B3
C1 C2 C3
```

The DIF™ Format

The following information is provided for experienced programmers.

The DIF format stores the worksheet in a form accessible to programs other than the VisiCalc program. To accommodate a wide range of languages in which such a program might be written, several simplifying techniques have been used:

- Information about the size of the file is provided at the beginning.
- Records are kept as short as possible.
- The data type (string or number) of each value is explicitly defined.
- Strings are stored one per line.
- Strings that contain special characters are enclosed in quotation marks.
- The file ends with an explicit End-Of-Data record.

Figure B-1 shows a sample worksheet used to describe the format and the programs that work with the DIF format.

Year	1980	1981	1982
Sales	100	110	121
Cost	80	88	97
Profit	20	22	24

Figure B-1. Sample Worksheet

The format stores the worksheet in a series of slices; the worksheet can be sliced either horizontally (by rows) or vertically (by columns). Each of these slices is called a tuple; each slice along the other axis is called a vector. In Figure B-1, for example, if the worksheet is saved by rows, the first vector is Year 1980 1981 1982 and the first tuple contains Year, - (one hyphen), Sales, Cost, and Profit; the entire worksheet is stored in four tuples of five values each.

If the worksheet in Figure B-1 is stored by columns, the first vector is Year -Sales Cost Profit and the first tuple contains Year 1980 1981 1982; the entire worksheet is stored in five tuples of four values each.

A DIF file consists of a series of *header* records that describe the file, followed by one set of *data* records for each tuple, and ends with a pair of *End-Of-Data* records.

Header

The header consists of four sets of three records that give information about the entire file:

TABLE
0,1
" "
VECTORS
0,V
" "
TUPLES
0,T
" "
DATA
0,0
" "

V is the number of vectors in the file.

T is the number of tuples in the file.

Data Records

The data records consist of a pair of header records that identify the beginning of a tuple, and a pair of records for each value in the tuple:

-1,0
BOT
T1,N1
string1
T2,N2
string2
T3,N3
string3
.
.
.
Tn,Nn
stringn

Beginning Of Tuple records.

First value of tuple.

Second value of tuple.

Third value of tuple.

Last (nth) value of tuple.

End-Of-Data Records

The End-Of-Data records mark the end of the file:

-1,0
EOD

Programs that Work With the DIF™ Format

The following three programs demonstrate how BASIC programs might be written and used with the DIF format. These are sample programs that must be typed in exactly or developed by programmers. These programs perform the following functions:

- Dump a DIF file just as it is stored, record by record.
- Print a worksheet from a DIF file.
- Create a DIF file by prompting for the worksheet entries.

Dumping a DIF™ File

This program prints the DIF file just as it is stored, record by record. It asks for the name of the file, and whether to print it. If not instructed to print the file, the program displays the file on the screen.

```

100 REM *****
110 REM *  INITIALIZATION  *
120 REM *****
130 NUL$ = CHR$ (34) + CHR$ (34)
140 FALSE = 0
150 TRUE = - 1
160 D$ = CHR$ (4): REM CTRL-D
170 SCR# = 0
450 REM
460 REM *****
470 REM *  MAIN ROUTINE  *
480 REM *****
490 REM
500 GOSUB 1000
510 GOSUB 1200
520 GOSUB 1400
530 GOSUB 1600
540 IF HARDCOPY THEN PRINT D$;"PR#0"
550 END
950 REM
960 REM *****
970 REM *  PROMPT FOR ORDERS  *
980 REM *****
990 REM

```

```

1000 HOME
1010 INPUT "FILE NAME : ";FI$
1020 IF RIGHT$(FI$,4) < > ".DIF" THEN FI$ = FI$ + ".DIF"
1030 INPUT "PRINT THE FILE (Y OR N) : ";REPLY$
1040 IF REPLY$ = "Y" THEN HARDCOPY = TRUE
1050 IF NOT HARDCOPY THEN HOME : RETURN
1060 IF HARDCOPY THEN PRINT D$;"PR#1"
1070 PRINT FI$: PRINT : PRINT
1080 RETURN
1150 REM
1160 REM *****
1170 REM * PRINT HEADER *
1180 REM *****
1190 REM
1200 PRINT D$;"OPEN ";FI$
1210 PRINT D$;"READ ";FI$
1220 INPUT TITLE$
1230 INPUT TYPE,NUMBER
1240 INPUT STRNG$
1250 PRINT TITLE$: PRINT TYPE;",";NUMBER
1260 IF STRNG$ = "" THEN PRINT NUL$: GOTO 1280
1270 PRINT STRNG$
1280 IF TITLE$ < > "DATA" THEN 1220
1290 IF NOT HARDCOPY THEN GOSUB 2000
1300 RETURN
1350 REM
1360 REM *****
1370 REM * PRINT DATA RECORDS *
1380 REM *****
1390 REM
1400 INPUT TYPE,NUMBER
1410 INPUT STRNG$
1420 IF SCRN > 10 AND NOT HARDCOPY THEN GOSUB 2000
1430 PRINT TYPE;",";NUMBER
1440 IF STRNG$ = "" THEN PRINT NUL$: GOTO 1460
1450 PRINT STRNG$
1460 IF STRNG$ < > "EOD" THEN SCRN = SCRN + 1: GOTO 1400
1470 RETURN
1540 REM
1550 REM *****
1560 REM * END-OF-PROGRAM *
1570 REM * CLEANUP *
1580 REM *****
1590 REM
1600 PRINT D$;"CLOSE ";FI$
1610 RETURN
1950 REM
1960 REM *****
1970 REM * PAUSE *
1980 REM *****
1990 REM
2000 FOR I = 1 TO 2000
2010 NEXT I
2020 SCRN = 0
2030 HOME
2040 RETURN

```

APPENDIX B

Printing a Worksheet from a DIF™ File

The following program prints the worksheet as it would appear on the screen. It asks for the name of the file in which the worksheet was saved in the DIF format, the width of columns to be printed, and whether the worksheet was saved by rows or by columns:

```

60 REM *****
70 REM * INITIALIZATION *
80 REM *****
90 REM
100 DIM WO$(50,50): REM WORKSHEET
110 FALSE = 0
120 TRUE = - 1
130 BYROWS = FALSE
140 D$ = CHR$(4): REM CTRL-D
450 REM
460 REM *****
470 REM * MAIN ROUTINE *
480 REM *****
490 REM
500 GOSUB 1000
510 GOSUB 1200
520 GOSUB 1400
530 GOSUB 1800
540 IF NOT FILEBAD THEN GOSUB 1600
550 IF HARDCOPY THEN PRINT D$;"PR#0"
560 END
950 REM
960 REM *****
970 REM * PROMPT FOR ORDERS *
980 REM *****
990 REM
1000 HOME
1010 INPUT "FILE NAME : ";FI$
1020 IF RIGHT$(FI$,4) < > ".DIF" THEN FI$ = FI$ + ".DIF"
1030 INPUT "COLUMN WIDTH : ";CW
1040 INPUT "SAVED BY ROW OR COLUMN (R OR C) : ";REPLY$
1050 IF REPLY$ = "R" THEN BYROWS = TRUE
1060 INPUT "PRINT THE WORKSHEET (Y OR N) : ";REPLY$
1070 IF REPLY$ = "Y" THEN HARDCOPY = TRUE
1080 RETURN
1150 REM
1160 REM *****
1170 REM * READ HEADER *
1180 REM *****
1190 REM
1200 PRINT D$;"OPEN ";FI$
1210 PRINT D$;"READ ";FI$
1220 INPUT TITLE$
1230 INPUT TYPE,NUMBER
1240 INPUT STRNG$
1250 IF TITLE$ = "VECTORS" THEN VECTRS = NUMBER
1260 IF TITLE$ = "TUPLES" THEN TUPLES = NUMBER
1270 IF TITLE$ = "DATA" THEN RETURN
1280 GOTO 1220

```



```
1350 REM
1360 REM *****
1370 REM * READ DATA RECORDS *
1380 REM *****
1390 REM
1400 FOR ROW = 1 TO TUPLES
1410 INPUT TYPE,NUMBER
1420 INPUT STRNG$
1430 IF TYPE < > - 1 OR STRNG$ < > "BOT" THEN GOSUB 2000: RETURN
1440 FOR COL = 1 TO VECTRS
1450 INPUT TYPE,NUMBER
1460 INPUT STRNG$
1470 IF TYPE < > 0 AND TYPE < > 1 THEN GOSUB 2000: RETURN
1475 GOSUB 2200
1480 IF BYROWS AND TYPE = 0 THEN WO$(COL,ROW) = NUMBER$: GOTO 1500
1490 IF BYROWS THEN WO$(COL,ROW) = STRNG$
1500 IF NOT BYROWS AND TYPE = 0 THEN WO$(ROW,COL) = NUMBER$: GOTO 1520
1510 IF NOT BYROWS THEN WO$(ROW,COL) = STRNG$
1520 NEXT COL
1530 NEXT ROW
1540 RETURN
1550 REM
1560 REM *****
1570 REM * PRINT WORKSHEET *
1580 REM *****
1590 REM
1600 IF BYROWS THEN WIDTH = TUPLES:DEPTH = VECTRS: GOTO 1620
1610 WIDTH = VECTRS:DEPTH = TUPLES
1620 FOR ROW = 1 TO DEPTH
1630 FOR COL = 1 TO WIDTH
1640 PRINT WO$(ROW,COL);
1650 NEXT COL
1660 PRINT
1670 NEXT ROW
1680 RETURN
1750 REM
1760 REM *****
1770 REM * CLOSE FILE *
1780 REM *****
1790 REM
1800 PRINT D$;"CLOSE ";FI$
1810 IF HARDCOPY THEN PRINT D$;"PR#1"
1820 RETURN
1950 REM
1960 REM *****
1970 REM * ERROR IN FILE *
1980 REM *****
1990 REM
2000 PRINT D$;"CLOSE ";FI$
2010 PRINT
2020 PRINT "ERROR IN FILE ... "
2030 PRINT TAB( 5);"TYPE =";TYPE
2040 PRINT TAB( 5);"NUMBER =";NUMBER
2050 PRINT TAB( 5);"STRING =";STRNG$
2060 FILEBAD = TRUE
2070 RETURN
```

```

2140 REM
2150 REM *****
2160 REM *   OFFSET   *
2170 REM * LABEL & NUMBERS *
2180 REM *****
2190 REM
2200 IF TYPE < > 0 THEN 2300
2210 NUMBER$ = STR$ (NUMBER)
2220 IF LEN (NUMBER$) > CW - 1 THEN NUMBER$ = " " + LEFT$ (NUMBER$,CW -
1): RETURN
2230 BLANK$ = "           "
2240 BN = CW - LEN (NUMBER$)
2250 NUMBER$ = LEFT$ (BLANK$,BN) + NUMBER$
2260 RETURN
2300 IF LEN (STRNG$) > = CW THEN STRNG$ = LEFT$ (STRNG$,CW): RETURN
2310 BLANK$ = "           "
2320 BN = CW - LEN (STRNG$)
2330 STRNG$ = STRNG$ + LEFT$ (BLANK$,BN)
2340 RETURN

```

Creating a DIF™ File

The following program prompts for worksheet entries (by row-column coordinate), then writes the entries on a diskette in a DIF file. Either a string or number (integer or real) can be entered. To enter a label that starts with a number, type a quotation mark (") as the first character of the label. To end a row, type **ESC-D RETURN**; to end the worksheet, type **ESC-D ESC-D RETURN**.

The program assumes the coordinate of the lower-right corner of the worksheet is the row-column coordinate of the location immediately to the left of the coordinate where **ESC-D ESC-D** is typed, so the last row should be at least as wide as all preceding rows. The worksheet is saved by rows:

```

60 REM *****
70 REM * INITIALIZATION *
80 REM *****
90 REM
100 ESC$ = CHR$ (27) + CHR$ (68)
110 LR$ = ESC$: REM LAST IN ROW
120 LS$ = ESC$ + ESC$: REM LAST ON SHEET
130 QUOTE$ = CHR$ (34)
140 NUL$ = QUOTE$ + QUOTE$
150 ROW = 1
160 COL = 1
170 FALSE = 0
180 TRUE = - 1
190 DIM WO$(50,50): REM DIM WORKSHEET
200 D$ = CHR$ (4): REM CTRL-D
450 REM
460 REM *****
470 REM * MAIN ROUTINE *
480 REM *****
490 REM

```

```

500 GOSUB 1000
510 GOSUB 1200
520 GOSUB 1400
530 GOSUB 2000
540 END
940 REM
950 REM *****
960 REM *   PROMPT   *
970 REM * FOR ORDERS *
980 REM *****
990 REM
1000 HOME
1010 INPUT "WRITE THE FILE (Y OR N): ";REPLY$
1020 IF REPLY$ = "Y" THEN DISKCOPY = TRUE
1030 IF DISKCOPY THEN INPUT "FILE NAME: ";FI$: IF RIGHT$(FI$,4) < >
".DIF" THEN FI$ = FI$ + ".DIF"
1040 RETURN
1140 REM
1150 REM *****
1160 REM *   PROMPT   *
1170 REM * FOR ENTRIES *
1180 REM *****
1190 REM
1200 HOME
1210 WO$(ROW,COL) = ""
1220 PRINT "ROW ";ROW;" , COLUMN "; CHR$(64 + COL);": ";
1230 GET REPLY$
1240 IF REPLY$ = CHR$(8) AND LEN(WO$(ROW,COL)) - 1 = 0 THEN PRINT "
": GOTO 1210
1250 IF REPLY$ = CHR$(8) THEN WO$(ROW,COL) = LEFT$(WO$(ROW,COL), LEN
(WO$(ROW,COL)) - 1): PRINT " ";WO$(ROW,COL);: GOTO 1230
1260 IF REPLY$ < > CHR$(13) THEN PRINT REPLY$;:WO$(ROW,COL) = WO$(RO
W,COL) + REPLY$: GOTO 1230
1270 PRINT
1280 IF WO$(ROW,COL) = L$$ THEN WIDTH = COL - 1:DEPTH = ROW: RETURN
1290 IF WO$(ROW,COL) = LR$ THEN ROW = ROW + 1:COL = 1: PRINT : GOTO 1210

1300 COL = COL + 1
1310 GOTO 1210
1320 REM
1330 REM *****
1340 REM * WRITE FILE *
1350 REM *****
1360 REM
1370 REM -----
1380 REM   HEADER
1390 REM -----
1400 IF NOT DISKCOPY THEN RETURN
1410 PRINT D$;"OPEN ";FI$
1420 PRINT D$;"DELETE ";FI$
1430 PRINT D$;"OPEN ";FI$
1440 PRINT D$;"WRITE ";FI$
1450 PRINT "TABLE"
1460 PRINT 0;",";1
1470 PRINT NUL$
1480 PRINT "VECTORS"
1490 PRINT 0;",";DEPTH

```

```
1500 PRINT NUL$
1510 PRINT "TUPLES"
1520 PRINT 0;",";WDTH
1530 PRINT NUL$
1540 PRINT "DATA"
1550 PRINT 0;",";0
1560 PRINT NUL$
1570 REM -----
1580 REM DATA RECORDS
1590 REM -----
1600 FOR COL = 1 TO WDTH
1610 PRINT - 1;",";0
1620 PRINT "BOT"
1630 FOR ROW = 1 TO DEPTH
1640 IF VAL (WO$(ROW,COL)) < > 0 OR WO$(ROW,COL) = "0" THEN PRINT 0;"
, "; VAL (WO$(ROW,COL)): PRINT "V": GOTO 1680
1650 IF LEFT$( WO$(ROW,COL),1) = QUOTE$ THEN WO$(ROW,COL) = MID$( WO$(
ROW,COL),2)
1660 PRINT 1;",";0
1670 PRINT QUOTE$;WO$(ROW,COL);QUOTE$
1680 NEXT ROW
1690 NEXT COL
1700 REM -----
1710 REM END-OF-DATA
1720 REM -----
1730 PRINT - 1;",";0
1740 PRINT "EOD"
1750 RETURN
1940 REM
1950 REM *****
1960 REM * END OF PROGRAM *
1970 REM * CLEAN UP *
1980 REM *****
1990 REM
2000 PRINT D$;"CLOSE ";FI$
2010 RETURN
```

A

@ symbol 2-8, 2-44, 3-70, 3-75 to 3-82
 aborting a command: see command
 @ABS(absolute value) 2-73, 3-76
 @ACOS 3-76
 @AND 3-80
 addition 2-8, 2-9, 2-11, 2-70 3-70
 ampersand (&) 3-43 to 3-48
 Apple 1-3, 1-5
 arguments in functions 2-69, 2-70 to 2-73, 3-75 to 3-81
 arithmetic operators 2-69, 3-70, 3-72
 arrow keys, right, left 1-4, 2-2 to 2-4, 2-6, 2-12, 3-70 to 3-71, 3-86
 @ASIN 3-76
 asterisk (*)
 graphing 2-74 to 2-79
 multiply sign 2-7, 2-8, 2-11, 2-70, 3-70
 @ATAN 3-76
 at sign (@) 2-8, 2-44, 3-70, 3-75 to 3-82
 automatic recalculation 2-78 to 2-79, 3-26
 automatic repeat 2-3, 2-31, 2-41, 3-87
 Autostart ROM 1-6, 2-15
 @AVERAGE 2-45, 2-71 to 2-72, 3-76

B

/B (see BLANK Command)
 backing out of a command 2-5
 back-up copies of files 2-16, 2-43
 bar graph format: see format
 beep 2-3

BLANK command 2-9, 2-15, 3-5
 blank entry 2-43, 3-51, 3-61, 3-76
 Boolean functions 3-79 to 3-81
 budget example 2-36 to 2-61
 built-in functions 2-44 to 2-45, 2-52, 2-70 to 2-78, 3-70, 3-75 to 3-82

C

/C (see CLEAR Command)
 calculated value 2-66 to 2-68, 3-66, 3-72, 3-81
 calculating interest 2-55 to 2-56
 calculation indicator 2-2, 2-62, 3-22, 3-74 to 3-75, 3-84
 calculations 2-61 to 2-64, 3-72 to 3-73
 caret (^) 2-70, 3-44 to 3-45, 3-70
 character string 3-44
 @CHOOSE 3-77
 circular reference 2-63 to 2-64, 3-59, 3-75
 CLEAR command 2-15, 2-66, 3-6
 clearing
 the status area 1-4, 2-3, 2-6, 3-85
 the sheet 2-15, 2-66, 3-6
 colon (;) 2-49
 columns 1-2, 2-1
 adjusting width 2-27 to 2-29, 2-50
 deleting 2-53, 3-7 to 3-10
 inserting 3-28, 3-30 to 3-31
 moving 3-34 to 3-36
 replicating 2-41 to 2-42, 2-48 to 2-49, 3-53 to 3-54

- comma (,) 2-13 to 2-14, 3-14 to 3-15, 3-61
- command 2-25
 - aborting 1-4, 2-3, 2-6, 3-85, 3-87
 - structure chart 3-4 to 3-5
- comparison operators 3-79 to 3-80
- coordinate 2-1, 2-2, 3-84
 - in replication 2-20 to 2-24, 3-51 to 3-52
 - as a value reference 2-68
- copying diskettes 2-16, A1
- correcting typing mistakes 2-5 to 2-7, 2-12, 3-11 to 3-13, 3-87
- @COS 3-76
- @COUNT 2-71, 3-76
- CTRL key 1-4, 3-44
- CTRL C 1-4, 2-3, 2-6, 3-85, 3-87
- CTRL E 2-12, 3-11 to 3-13, 3-32
- cursor 2-2, 3-84, 3-86
 - direction indicator 2-2, 3-5 3-6, 3-84, 3-85
 - moving keys 2-2, 3-71, 3-86
 - pointing with the 2-10 to 2-11, 3-86, 3-87
- D**
- /D (see DELETE Command)
- Data Interchange Format 2-13, 3-14, 3-66 to 3-67 B-1 to B-12
- default 3-15, 3-61, 3-64
- delete
 - columns 2-53, 3-7 to 3-10
 - entry contents: see BLANK command
 - files from diskette 2-15, 3-64
 - rows 2-53, 3-7
- DELETE command 2-53, 2-65, 3-7 to 3-10
- delimiter 2-13 to 2-14, 3-14 to 3-15, 3-61
- direction indicator 2-2, 3-5, 3-6, 3-84, 3-85
- directory, diskette 2-13
 - scrolling 2-19, 3-15, 3-61 to 3-62
- disk drive 1-3
 - default 3-15
 - specification 3-14 to 3-15
- diskette 1-3, 1-7
 - backing up 2-16, 2-43
 - care and use 1-4
 - initializing 1-7 to 1-9
 - saving files on 2-12 to 2-15, 2-16, 2-35, 2-43, 2-52 to 2-53, 3-16, 3-62 to 3-65, 3-66 to 3-67
 - write protect 1-7
- division 2-10, 2-70, 3-70
- dollars and cents format 2-25, 2-46 to 2-48, 3-17, 3-20
- DOS 3.3 A1
- dynamic memory allocation 2-34 to 2-35
- E**
- /E (see EDIT command)
- EDIT command 2-12, 2-39, 3-11 to 3-13, 3-32, 3-87
- edit cue 2-4, 2-12, 2-21, 3-71
- edit line 2-1, 2-11, 3-21, 3-84, 3-85
- electronic worksheet 1-1, 2-1, 3-86
 - clearing 2-15, 2-66, 3-6
 - combining sheets 2-18 to 2-19, 3-60 to 3-62
 - memory requirements 1-3
 - printing: see printing
 - saving on diskette: see saving
 - shrinking 2-35

INDEX

ellipsis 2-21, 2-70
 entry line 2-1, 2-7, 3-21,
 3-71, 3-84 to 3-85
 entry position 3-86
 adjusting width 3-16
 formatting: see format,
 local
 equals (=) 3-79
 equipment requirements 1-3
 erasing files: see delete,
 files from diskette
 ERROR 2-52, 3-7, 3-9, 3-25
 3-75
 ERROR: DISK FULL 3-63
 @ERROR 2-52, 2-71, 3-79 to
 3-81
 errors
 arithmetic 3-72
 erasing 2-5, 2-12
 ESC key 2-5, 2-12, 2-53, 3-61
 to 3-62, 3-85
 exclamation point key (!) 2-2,
 2-7, 2-61 to 2-63, 2-68,
 2-79, 3-25, 3-73 to 3-74,
 3-84, 3-85
 @EXP (exponential) 2-77,
 3-76
 exponentiation 2-70
 explicit formats: see formats
 expressions 2-69 to 2-70,
 2-72

F

/F (see FORMAT Command)
 @FALSE 3-79 to 3-80
 files
 Data Interchange Format
 3-14
 deleting 2-15, 3-64
 directory of 3-14
 print format 3-14, 3-47 to
 3-48
 printing to 3-47 to 3-48
 file name 2-13, 2-16, 2-19,
 2-53, 3-14 to 3-15, 3-61
 to 3-62

 suffixes 2-13 to 2-14, 3-14
 to 3-15, 3-61 to 3-62
 fixing titles: see titles
 FORMAT command 2-46 to
 2-48, 3-16 to 3-20
 formats, file: see files
 formatting a single entry:
 see format, local
 formatting the screen
 display: see global
 commands
 format 2-46 to 2-48, 2-64
 bar graph 2-74 to 2-79,
 3-20
 default 2-47, 3-17
 dollars and cents 2-25
 2-46 to 2-48, 3-17,
 3-20
 general 2-47, 2-66, 3-16,
 3-17
 global: see global
 graph 2-47, 2-74 to 2-79,
 3-20
 indicator 2-48, 3-16, 3-84
 integer 2-24, 2-27, 2-66 to
 2-67, 3-18
 left justify 2-47, 2-74,
 3-17 to 3-19
 local (or explicit) 2-47,
 2-66, 3-17
 printing 2-16, 3-47 to 3-48
 replicating 2-48, 3-16
 right justify 2-47, 3-17,
 3-19
 formulas 2-10 to 2-11, 2-68
 to 2-70, 3-70 to 3-71
 position on the sheet 2-53
 to 2-54
 printing 2-16, 3-47 to 3-48
 replicating 2-38 to 2-39
 forward reference 2-63 to
 2-64, 3-23, 3-59, 3-75
 functions
 Boolean 3-79 to 3-80
 built-in 2-44 to 2-45, 2-52
 2-79 to 2-78, 3-75 to 3-82

transcendental 2-74 to
2-79, 3-76

G

/G (see GLOBAL command)

general format: see format

GLOBAL command 2-25,
2-33, 3-21 to 3-26

global commands

columns 2-50, 3-16, 3-21

formats 2-46, 2-64, 3-26

general 2-66 to 2-67,
3-16

integer 2-24, 2-27, 2-66
to 2-67

formatting the screen
display 2-24 to 2-25

in separate windows 2-50,
2-53, 3-26, 3-90

manual or automatic
recalculation 2-78 to
2-79, 3-26

order of recalculation 2-61
to 2-63, 3-22 to 3-25

GO TO command 2-4 to 2-5
3-27, 3-86

graph format 2-47, 2-74 to
2-79, 3-20

graphing a function 2-74 to
2-79

greater than character (>)
2-4 to 2-5, 2-32, 2-67,
3-21, 3-27, 3-72, 3-86

H

hardcopy: see PRINT

highlight: see cursor

I

/I (see INSERT command)

@IF 3-80

initializing diskettes 1-7 to
1-9, 2-12, 3-64 to 3-65, A1

INSERT command 2-53 to
2-55, 2-65, 3-9, 3-28 to
3-31, 3-76

inserting

columns 3-28, 3-30 to 3-31
rows 2-53 to 2-55, 3-28,
3-30 to 3-31

@INT (integer) 2-73, 3-76,
3-82

integers 2-24, 2-27, 2-66 to
2-67, 2-74, 3-18, 3-21

rounding 2-66, 3-18, 3-21

@ISERROR 3-80 to 3-81

@ISNA 3-80 to 3-81

K

key

automatic repeat 2-3, 2-31,
2-41, 3-87

symbols 1-4, 3-86

keyboard 1-4

L

/L (see LABEL command)

LABEL ENTRY command
3-17, 3-32 to 3-33

labels 2-6, 2-7 to 2-9,
3-32 to 3-33, 3-76, 3-84

formatting: see format
repeating 2-38, 3-49 to
3-50

Lanaguage System™ 1-3,
1-6

left justify 2-47, 2-74, 3-17
to 3-19

left-pointing arrow key 1-4,
2-2 to 2-4, 2-6, 2-12,
3-70 to 3-71, 3-86

less than symbol (<) 3-79

list 2-45, 2-70, 3-76 to 3-77

@LN 2-76, 3-76

loading

a sheet from diskette 2-18
to 2-19, 3-60 to 3-62, 3-67

VisiCalc 1-5

local formats: see formats

INDEX

- @LOG10 3-76
- logarithm 3-76
- @LOOKUP (table lookup)
 - 2-72 to 2-73, 3-77 to 3-78
- M**
- M (out of Memory) 2-35, 3-88
- /M (see MOVE Command)
- manual recalculation 2-78 to 2-79, 3-26
- @MAX 2-45, 2-71, 3-76
- memory 1-3, 2-34 to 2-35, 3-88
- memory indicator 2-2, 2-34 to 2-35, 3-85, 3-87
- @MIN 2-45, 2-71, 3-76
- minus sign 2-2, 2-8, 2-11, 2-38, 2-70, 3-49 to 3-50, 3-70, 3-84, 3-85
- MOVE command 2-57 to 2-58 3-31, 3-34 to 3-40
- moving
 - columns 3-34 to 3-36
 - rows 2-57, 3-36 to 3-39
 - the cursor 2-2 to 2-5, 2-10 to 2-11
 - the window: see scrolling
- MUFFIN A1
- multiplication 2-7, 2-8, 2-11, 2-70, 3-70
- N**
- @NA (Not Available) 2-52, 2-71, 3-79
- naming diskette files: see file name
- noise 2-3, 3-86
- @NOT 3-80
- not equals symbol (< >) 3-79
- @NPV (Net Present Value) 2-72, 3-76 to 3-77
- numbers
 - format: see format
 - replicating: see replicating
 - scientific notation 2-67 to 2-68, 3-17, 3-21, 3-70, 3-72
 - number sign (#): see pound sign
- O**
- operands 2-69
- operators 2-69
- @OR 3-80
- order of precedence 2-58, 2-69 to 2-70
- order of recalculation 2-61 to 2-63, 3-22 to 3-25, 3-74 to 3-75
- over-writing a sheet 3-60 to 3-61
- P**
- /P (see PRINT Command)
- parentheses 2-69 to 2-70, 3-72, 3-75 to 3-76
- percentage 2-46, 2-59
- @PI 2-77, 3-79
- plus sign 2-8, 2-9, 2-11, 2-70, 3-70
- pointing 2-10 to 2-11, 3-87
- pound sign (#) 2-8, 2-68, 3-14, 3-66 to 3-67, 3-70, 3-73 to 3-74
- powers 2-70
- precision 2-66 to 2-68, 3-66, 3-72, 3-81
- precedence in formulas 2-58, 2-69 to 2-70, 3-72
- PRINT command 2-65, 3-40 to 3-48
- print file format (/PF, /PD) 3-47 to 3-48, 3-66
- printers 3-40 to 3-48
 - saving to 2-16, 3-47 to 3-48
- printing
 - the worksheet 3-40 to 3-48
 - formulas and formats 2-16, 3-47 to 3-48

in sections 3-46 to 3-47
prompt line 1-8, 2-1, 3-84 to
3-85

Q

quit VisiCalc 3-65
quotation mark (") 2-8, 3-32,
3-44 to 3-45

R

/R (see REPLICATE
Command)

RAM 2-34

range

in functions 2-44 to 2-46,
2-70 to 2-73, 3-30 to 3-31,
3-76 to 3-77

with REPLICATE 2-20 to
2-24, 2-41

recalculation 2-8, 2-27

automatic 2-78 to 2-79,
3-26

manual 2-78 to 2-79, 3-26
order of 2-61 to 2-63, 3-22
to 3-25, 3-74 to 3-75

problems with (circular or
forward reference) 2-63
to 2-64, 3-23, 3-59, 3-75

recalculation order indicator
2-2, 2-62, 3-22, 3-74 to
3-75, 3-84

rectangular box: see cursor

reevaluation: see recalcula-
tion

relative, when using

REPLICATE 2-21 to
2-24, 2-38 to 2-42, 2-48,
2-56, 3-56 to 3-59

repeat key (REPT) 2-3, 2-31,
2-41, 3-86

REPEATING LABEL

command 2-38, 3-49 to
3-50

REPLICATE command 2-20
to 2-24, 2-33, 2-37 to

2-38, 2-48, 2-59, 3-51 to
3-59

replicating

a column 2-41 to 2-42, 2-48
to 2-49, 3-53 to 3-54

one entry position 3-52 to
3-53

a format specification
2-48, 3-51, 3-53

a range of entries 2-23 to
2-24

a row 2-48 to 2-49, 3-55 to
3-56

across a row 2-20, 2-37 to
2-38

down a column 2-40 to
2-41, 3-53

formulas 2-20 to 2-24, 2-38
to 2-39

labels 2-38

numbers 2-37 to 2-38

value references 3-56 to
3-59

RESET key 1-6, 2-14 to 2-15

RETURN key 1-4, 2-2, 3-32,
3-34, 3-36, 3-70, 3-71, 3-87

reversing rows and columns
3-66 to 3-67

right-justify 2-47, 2-74, 3-18

right-pointing arrow key 1-4,
2-2 to 2-4, 2-6, 2-12, 2-19,
3-15, 3-61, 3-86

ROM 2-34

rounding 2-66, 3-81

rows 1-2, 2-1, 3-88

deleting

inserting 2-53 to 2-55,
3-28, 3-30 to 3-31

moving 2-57, 3-36 to 3-39

S

/S (see STORAGE Command)

saving the electronic sheet
on diskette 2-12 to 2-15,
2-16, 2-35, 2-43, 2-52 to

INDEX

- 2-53, 3-16, 3-62 to 3-65,
3-66 to 3-67
 - scientific notation 2-67 to
2-68, 3-17, 3-21, 3-70, 3-72
 - screen
 - splitting: see splitting the
window
 - VisiCalc screen 3-84 to
3-87
 - screen window: see window
 - scrolling
 - the directory 2-19, 3-15,
3-61 to 3-62
 - the window 1-1, 2-3, 2-30,
2-44, 3-86
 - semi-colon (;) 2-30 to 2-32,
2-60, 3-90
 - "SETUP string 3-44 to 3-47
 - setting up the computer 1-3
to 1-7
 - SHIFT key (s) 1-4, 2-2, 3-70
 - shrinking the electronic
worksheet 2-35
 - significant digits 2-69, 3-17,
3-21
 - @SIN 2-77 to 2-78, 3-76
 - slash (/) 2-10, 2-25, 2-70, 3-70
 - slot number 1-6, 1-8, 3-15,
3-61, 3-64
 - source range
 - in REPLICATE 2-20, 2-23,
3-51 to 3-52
 - in MOVE 2-57 to 2-58,
3-31, 3-34 to 3-40
 - splitting the window
 - global command effects
2-32
 - horizontally 2-31, 2-60,
3-88 to 3-90
 - vertically 2-29 to 2-30,
2-50, 2-60, 3-90 to 3-91
 - @SQRT (square root) 3-76
 - status area 2-1, 3-71, 3-84 to
3-85
 - STORAGE command 1-8,
2-12 to 2-14, 2-19, 2-35,
2-43, 2-52 to 2-53, 3-16,
3-47 to 3-48, 3-60 to 3-67
B-1 to B-12
 - storage diskette: see
diskette
 - subtraction 2-8, 2-11, 2-70,
3-70
 - suffixes
 - slot and drive designation
2-13 to 2-14, 3-14 to 3-15,
3-61, 3-64
 - .DIF 3-14, 3-66
 - .PF 3-14, 3-66
 - .VC 2-14, 3-14, 3-15, 3-66
 - @SUM 2-70 to 2-71, 3-75 to
3-76
 - synchronizing split windows:
see window
- T**
- /T (see TITLE Command)
 - @TAN 3-76
 - target range
 - in MOVE 2-57 to 2-58,
3-31, 3-34 to 3-40
 - in REPLICATE 2-20 to
2-21, 2-23, 2-41, 3-51 to
3-52
 - thud 2-3, 3-86
 - TITLES command 2-26, 2-33,
2-43 to 2-44, 2-60, 3-21,
3-27, 3-42, 3-68 to 3-69
 - titles
 - in split window 2-50 to
2-51
 - fixing in both directions
2-26, 2-43 to 2-44, 2-60
 - fixing horizontally 2-26,
2-43
 - fixing vertically 2-26, 2-43
 - unfixing 2-26, 3-21
 - transcendental functions
2-74 to 2-79, 3-76

trigonometric functions 3-76
transposing rows and
 columns 3-66 to 3-67
@TRUE 3-79 to 3-80
typeahead 3-87

U

unfixing titles: see titles
unsynchronizing split
 windows: see window

V

/V (see VERSION Command)
value 2-6, 2-7 to 2-9, 2-44 to
 2-46, 2-67, 3-17, 3-21, 3-84
VALUE ENTRY command
 2-44 to 2-46, 3-17, 3-70 to
 3-82
value reference 2-53 to 2-54,
 2-68 to 2-69, 3-70 to 3-72
 in DELETE 2-54, 3-7
 in INSERT 2-53
 in MOVE 2-57
 in REPLICATE 3-56 to 3-59
VERSION command 2-2, 3-83
version number 2-1, 2-2, 3-83
VisiCalc
 built-in functions 2-44 to
 2-45, 2-52, 2-70 to 2-78,
 3-70, 3-75 to 3-82
 equipment requirements
 1-3
 program diskette 1-3
 screen 3-84 to 3-87
 Reference Card 2-33
 version 2-1, 2-2

W

/W (see WINDOW Command)
warranty 1-3
window 1-1, 3-71, 3-85
 jumping between 2-30 to

 2-32, 2-60, 3-90
 scrolling 1-1, 2-3, 2-30 to
 2-31, 2-60 to 2-61, 3-86,
 3-91
 single 2-30, 2-53, 2-60,
 3-90, 3-91
 splitting horizontally 2-31,
 2-60, 3-88 to 3-90
 splitting vertically 2-29 to
 2-30, 2-50, 2-60, 3-90 to
 3-91
 synchronizing 2-60, 3-91
 titles in 2-50 to 2-51
 unsynchronizing 2-60,
 2-61, 3-91
WINDOW command 2-29 to
 2-33, 2-49 to 2-50, 3-42,
 3-88 to 3-91
writing on the electronic
 sheet 2-6 to 2-7

INDEX OF SPECIAL CHARACTERS

(in ascending order by ASCII
code)
! direction indicator 2-2,
 3-84, 3-85
! calculate 2-7, 2-61 to 2-63,
 2-68, 2-79, 3-25, 3-73 to
 3-74
> go to 2-4 to 2-5, 3-21, 3-27,
 3-86
> greater than 2-32, 2-67,
 3-72
" 2-8, 3-32, 3-44 to 3-45
store DIF 2-13, 3-14, 3-66
 to 3-67

INDEX

- # freeze value 2-8, 2-68, 3-70, 3-73 to 3-74
- (2-8, 3-70
-) 2-44
- ; 2-30 to 2-32, 2-60, 3-90
- @ 2-8, 2-44, 3-70, 3-75 to 3-82
- . 2-21 to 2-22, 2-44, 3-70
- / divide 2-10, 2-70, 3-70
- / command mode 2-25
- * multiply 2-7, 2-8, 2-11, 2-70, 3-70
- * graphing 2-74 to 2-79
- * loading 2-19, 3-61
- + addition 2-8, 2-9, 2-11, 2-70, 3-70
- ' 2-13 to 2-14, 3-14 to 3-15, 3-61
- minus sign 2-8, 2-11, 2-70, 3-70
- direction indicator 2-2, 3-84, 3-85
- repeating label 2-38, 3-49 to 3-50
- : 2-49
- ^ 2-70, 3-44 to 3-45, 3-70
- (R) 1-4

READER'S CRITIQUE

VISICALC® USER'S
GUIDE
10911-2212

VisiCorp's Publications Department wants to provide documents that meet the needs of all our product users. Your feedback helps us produce better manuals.

Please tell us how you rate this manual in the following areas:

	Excellent	Good	Average	Fair	Poor
1. Completeness of information.	<input type="checkbox"/>	<input type="checkbox"/>	<input type="checkbox"/>	<input type="checkbox"/>	<input type="checkbox"/>
2. Clarity of information.	<input type="checkbox"/>	<input type="checkbox"/>	<input type="checkbox"/>	<input type="checkbox"/>	<input type="checkbox"/>
3. Organization of manual.	<input type="checkbox"/>	<input type="checkbox"/>	<input type="checkbox"/>	<input type="checkbox"/>	<input type="checkbox"/>
4. Appearance of manual.	<input type="checkbox"/>	<input type="checkbox"/>	<input type="checkbox"/>	<input type="checkbox"/>	<input type="checkbox"/>
5. Quantity of examples.	<input type="checkbox"/>	<input type="checkbox"/>	<input type="checkbox"/>	<input type="checkbox"/>	<input type="checkbox"/>
6. Usefulness of examples.	<input type="checkbox"/>	<input type="checkbox"/>	<input type="checkbox"/>	<input type="checkbox"/>	<input type="checkbox"/>
7. Quantity of photographs and illustrations.	<input type="checkbox"/>	<input type="checkbox"/>	<input type="checkbox"/>	<input type="checkbox"/>	<input type="checkbox"/>
8. Appropriateness of photographs and illustrations.	<input type="checkbox"/>	<input type="checkbox"/>	<input type="checkbox"/>	<input type="checkbox"/>	<input type="checkbox"/>
9. Degree to which this manual meets your expectations and needs.	<input type="checkbox"/>	<input type="checkbox"/>	<input type="checkbox"/>	<input type="checkbox"/>	<input type="checkbox"/>
10. Appropriateness of the manual level to a person of your experience.	<input type="checkbox"/>	<input type="checkbox"/>	<input type="checkbox"/>	<input type="checkbox"/>	<input type="checkbox"/>
11. Overall manual.	<input type="checkbox"/>	<input type="checkbox"/>	<input type="checkbox"/>	<input type="checkbox"/>	<input type="checkbox"/>
How much computer experience do you have?		2 years or less <input type="checkbox"/>	2-5 years <input type="checkbox"/>	Over 5 years <input type="checkbox"/>	

Please specify, by page, any errors you found in this manual.

We would appreciate hearing any other comments and suggestions you have about this manual.

Name _____

Company _____

Street _____

City _____ State _____ Zip _____



No Postage
Necessary
If Mailed
in the
United States

BUSINESS REPLY MAIL

FIRST CLASS PERMIT NO. 7066 SAN JOSE, CA 95134

POSTAGE WILL BE PAID FOR BY ADDRESSEE

VISICORP
2895 Zanker Road
San Jose, CA 95134





VISICORP™
PERSONAL SOFTWARE™

2895 Zanker Road
San Jose, California 95134
Telephone 408/946-9000

10911-2212 1/82