



8501

WANG LAPTOP COMPUTER

COMPANY PROPRIETARY STATEMENT

This document is the property of Wang Laboratories, Inc. All information contained herein is considered Company Proprietary, and its use is restricted solely to assisting you in servicing Wang products. Neither this document nor its contents may be disclosed, copied, revealed, or used in whole or in part for any other purpose without the prior written permission of Wang Laboratories, Inc. This document must be returned upon request of Wang Laboratories, Inc.

**Customer Engineering
Product Maintenance Manual**

741-1747

COMPANY CONFIDENTIAL

PREFACE

This document is the Illustrated Product Maintenance Manual for the Wang Wang Laptop Computer. The scope of this manual reflects the type of maintenance philosophy selected for this product (swap unit, printed circuit assembly, power supply, or any combination thereof).

The purpose of this manual is to provide instructions to operate, troubleshoot, and repair the Wang Laptop Computer. It will be updated on a regular schedule.

First Edition (December, 1986)

This is an edition of the Wang Laptop Computer Product Maintenance Manual. The material in this document may only be used for the purpose stated in the Preface. Updates and/or changes to this document will be published as PUBs or subsequent editions.

©Copyright 1986 by WANG Laboratories, Inc.

PUBLICATION UPDATE BULLETIN

TITLE: WANG LAPTOP COMPUTER

DATE: 03/31/87

This PUB affects: 741-1747
742-1747

CLASS CODE: 8501

Previous Notice(s): none

REASON FOR CHANGE:

This PUB adds information about 3 1/2" and 5 1/4" floppy drives, adds recommended spares for the 5 1/4" drive, and corrects information about connections to Main PCB.

INSTRUCTIONS:

Remove and insert attached pages and/or microfiche as follows:

	REMOVE PAGES	INSERT PAGES
1.	v/vi thru vii/--	v/vi thru ix/--
2.	TOC for Section 7	TOC for Section 7
3.	7-23/24 and 7-25/26	7-23/24 and 7-25/26
4.	7-43/44 thru 7-47/--	7-43/44 thru 7-111/--
5.	12-15/16 and 12-17/18	12-15/16 and 12-17/18
6.		
7.		
8.		
9.		
10.		

	REMOVE FICHE	INSERT FICHE
1.	Fiche 1	Fiche 1
2.	Fiche 2	Fiche 2
3.	Fiche 3	Fiche 3
4.		

This page constitutes a permanent record of revisions; place it directly following title page.



LABORATORY

ONE INDUSTRIAL AVENUE LOWELL MASSACHUSETTS 01851 TEL: (617) 459 5000 TWX 710 343 6769 TELEX 94 7421

COMPANY PROPRIETARY STATEMENT

This document is the property of Wang Laboratories, Inc. All information contained herein is considered Company Proprietary, and its use is restricted solely to assisting you in servicing Wang products. Neither this document nor its contents may be disclosed, copied, revealed, or used in whole or in part for any other purpose without the prior written permission of Wang Laboratories, Inc. This document must be returned upon request of Wang Laboratories, Inc.

© Copyright 1987, Wang Laboratories, Inc.

COMPANY CONFIDENTIAL

TABLE OF CONTENTS

SECTION 1 INTRODUCTION

	Page
1.1 SCOPE AND PURPOSE	1-1
1.2 ORGANIZATION AND LAYOUT	1-2

SECTION 2 IDENTIFICATION

	Page
2.1 WLTC BASE UNIT.....	2-1
2.2 WLTC OPTIONS.....	2-1A
2.3 CPU	2-2
2.3.1 External Identification	2-2
2.3.2 Internal Identification - Lower Case Items.....	2-6
2.3.3 Internal Identification - Upper Case Items	2-13

SECTION 3 CONTROLS AND INDICATORS

	Page
3.1 OPERATOR CONTROLS	3-1
3.2 OPERATOR INDICATORS	3-3
3.3 SERVICE CONTROLS	3-4
3.4 SERVICE INDICATORS	3-5
3.4.1 Voltage Test Points, CPU	3-5
3.4.2 Voltage Test Points, 3.5-inch FDD	3-6
3.4.3 Voltage Test Points, 5.25-inch FDD	3-7
3.5 OPERATOR CONTROLS, 5.25-INCH FDD	3-8

TABLE OF CONTENTS

SECTION 4 OPERATION

	Page
4.1 TOOLS AND TEST EQUIPMENT	4-1
4.2 PRINTER OPERATION	4-2
4.2.1 Matrix Operation	4-2
4.2.2 Thermal Operation	4-3
4.3 WARM RESTART	4-4

SECTION 5 PREVENTIVE MAINTENANCE

Do not attempt preventive maintenance on the Wang LapTop Computer; No preventive maintenance is required.

SECTION 6 TROUBLESHOOTING

	Page
6.1 TOOLS AND TEST EQUIPMENT	6-1
6.2 BUILT IN TEST	6-2
6.2.1 Brief Description	6-2
6.2.2 Setting BIT Mode	6-4
6.2.3 Manufacturing Diagnostic Menu	6-6
6.2.4 BIT Error Messages	6-8
6.3 CUSTOMER DIAGNOSTIC UTILITY	6-9A
6.4 SERVICE DIGNOSTIC UTILITY	6-9C
6.5 TROUBLESHOOTING CHART	6-10

TABLE OF CONTENTS

SECTION 7 REPAIR

	Page
7.1 TOOLS AND TEST EQUIPMENT	7-1
7.2 INTERNAL CONNECTORS	7-2
7.2.1 Disconnecting FPC Connectors	7-2
7.2.2 Reconnecting FPC Connectors	7-3
7.2.3 Disconnecting Mini-Connectors	7-5
7.2.4 Reconnecting Mini-Connectors	7-6
7.2.5 Matching Print Head to Printer PCB	7-7A
7.3 REMOVAL PROCEDURES	7-8
7.3.1 Rear Cover	7-8
7.3.2 OPT RAM PCB Assembly	7-9
7.3.3 Modem PCB Assembly	7-10
7.3.4 LCD Assembly	7-11
7.3.5 Battery Cover	7-12
7.3.6 NICAD BATT Assembly	7-13
7.3.7 Arm Cap R	7-14
7.3.8 Platen Knob Assembly	7-15
7.3.9 Cassette Cover Assembly	7-16
7.3.10 Separating Upper Case From Lower	7-17
7.3.10A Earth SP	7-19A
7.3.11 Reset Button	7-20
7.3.12 STD RAM PCB	7-21
7.3.13 Sub Batt Assembly	7-22
7.3.14 Power PCB Assembly	7-23
7.3.15 Main PCB	7-24
7.3.16 Lower Case	7-26
7.3.17 HDD PCB (SCSI)	7-27
7.3.18 HDD Cable 26	7-29
7.3.19 HDD Cable 50	7-30
7.3.20 HDD Power Cable 4-Pin	7-31
7.3.21 Printer PCB Assembly	7-31A
7.3.22 HDD Assembly	7-32
7.3.23 Printer Assembly	7-33
7.3.24 K/B Full Assembly	7-34

TABLE OF CONTENTS

SECTION 7 REPAIR

	Page
7.4 REINSTALLATION PROCEDURES	7-35
7.4.1 Rear Cover	7-35
7.4.2 OPT RAM PCB Assembly	7-36
7.4.3 Modem PCB Assembly	7-37
7.4.4 LCD Assembly	7-38
7.4.5 Battery Cover	7-39
7.4.6 NICAD BATT Assembly	7-40
7.4.7 Arm Cap R	7-42
7.4.8 PLaten Knob Assembly	7-43
7.4.9 Cassette Cover Assembly	7-44
7.4.10 Reconnect Upper and Lower Case	7-45
7.4.11 Earth SP	7-47
7.4.12 Reset Button	7-49
7.4.13 STD RAM PCB	7-50
7.4.14 Sub Batt Assembly	7-51
7.4.15 Power PCB Assembly	7-53
7.4.16 Main PCB	7-54
7.4.17 Lower Case	7-56
7.4.18 HDD PCB (SCSI)	7-57
7.4.19 HDD Cable 26	7-59
7.4.20 HDD Cable 50	7-60
7.4.21 HDD Power Cable 4-Pin	7-61
7.4.22 Printer PCB Assembly	7-62
7.4.23 HDD Assembly	7-65
7.4.24 Printer Assembly	7-66
7.4.25 K/B Full Assembly	7-69
7.5 REMOVAL PROCEDURES, 3.5-INCH FDD	7-70
7.5.1 Access	7-70
7.5.2 Battery Lid	7-72
7.5.3 NICAD Battery	7-73
7.5.4 Power SW Assembly	7-74
7.5.5 Power Jack Assembly	7-75
7.5.6 Power PCB Assembly	7-76
7.5.7 FDD IF Cable	7-78

TABLE OF CONTENTS

SECTION 7 REPAIR

	Page
7.5.8 FDD	7-79
7.5.9 SCSI PCB Assembly	7-81
7.5.10 SCSI Cable Assembly	7-82
7.6 REINSTALLATION PROCEDURES, 3.5-INCH FDD	7-83
7.6.1 Reassembly	7-83
7.6.2 Battery Lid	7-85
7.6.3 NICAD Battery	7-86
7.6.4 Power SW Assembly	7-87
7.6.5 Power Jack Assembly	7-88
7.6.6 Power PCB Assembly	7-89
7.6.7 FDD IF Cable	7-91
7.6.8 FDD	7-92
7.6.9 SCSI PCB Assembly	7-94
7.6.10 SCSI Cable Assembly	7-96
7.7 REMOVAL PROCEDURES, 5.25-INCH FDD	7-97
7.7.1 Access	7-97
7.7.2 Power PCB Assembly	7-99
7.7.3 FDD	7-101
7.7.4 SCSI PCB Assembly	7-102
7.7.5 SCSI BUS Cable	7-103
7.8 REINSTALLATION PROCEDURES, 5.25-INCH	7-104
7.8.1 Reassembly	7-104
7.8.2 Power PCB Assembly	7-106
7.8.3 FDD	7-109
7.8.4 SCSI PCB Assembly	7-110
7.8.5 SCSI BUS Cable	7-111

TABLE OF CONTENTS

SECTION 8 ADJUSTMENTS

	Page
8.1 TOOLS AND TEST EQUIPMENT	8-1
8.2 ADJUSTING LCD ARM PRESSURE PLATE	8-2

SECTION 9 UNPACKING AND SETUP

	Page
9.1 TOOLS AND TEST EQUIPMENT	9-1
9.2 CHECKING SHIPMENT	9-2
9.3 UNPACKING CARTONS.....	9-3
9.4 SET-UP	9-4

SECTION 10 FUNCTIONAL DESCRIPTION

To Be Supplied.

SECTION 11 SPECIFICATIONS

	Page
11.1 WLTC CPU	11-1
11.2 FDDs	11-3
11.3 OPTIONS	11-4

TABLE OF CONTENTS

SECTION 12 ILLUSTRATED PARTS

	Page
12.1 RECOMMENDED SPARES LIST	12-0
12.1.1 WLTC, Base Unit	12-0
12.1.2 Options	12-2
12.1.3 Lower Case Items	12-4
12.1.4 Upper Case Items	12-6
12.1.5 FDD (3.5 in.).....	12-12
12.1.6 FDD (5.25 in.).....	12-16

SECTION

1

INTRODUCTION

SECTION 1 CONTENTS

SECTION 1 INTRODUCTION

	Page
1.1 SCOPE AND PURPOSE	1-1
1.2 ORGANIZATION AND LAYOUT	1-2

1.1

Scope And Purpose

The Wang Laptop Computer is a portable, 70116-based (V30 series) computer with 512K of memory which is expandable to a full megabyte. It is capable of locally executing Wang programs, emulating an IBM PC, and executing IBM software. It also connects to external devices or networks via modem or standard I/O connections.

This manual contains information required to service Wang Laptop Computer; specifically to:

- identify equipment parts,
- understand controls and indicators,
- operate,
- perform preventive maintenance,
- troubleshoot,
- repair,
- and adjust

the Wang Laptop Computer.

This manual also presents an illustrated breakdown of field-replacable parts.

1.2

Organization And Layout

INTRODUCTION

Twelve sections, numbered 1 through 12, comprise this manual. Each section describes a separate field-service subject. A section Table of Contents is presented at the start of each section.

Information is arranged so that only three levels of subdivision are used:

e.g., 7 REPAIR
 7.2 Removal Procedures
 7.2.8 Control Board.

Whenever possible, items are presented in logical sequence: tasks performed first are presented first. Referencing is kept to a minimum and, when necessary, is made to section number.

When required, information is continued on following pages and all pages involved are marked "sheet x of n".

Symbols are used whenever their use will speed recognition and comprehension. Three special symbols used in this manual are:

- ▶ (section number)--directs reader to a specified section for more detail
- ▶ NEXT --directs reader to next page for continuing information
- END --informs reader that continuing information is complete.

SECTION

2

IDENTIFICATION

SECTION 2 CONTENTS

SECTION 2 IDENTIFICATION

		Page
2.1	WLTC Base Unit	2-1
2.2	WLTC Options	2-1A
2.3	CPU	2-2
2.3.1	External Identification	2-2
2.3.2	Internal Identification - Lower Case Items.....	2-6
2.3.3	Internal Identification - Upper Case Items	2-13

2.1

WLTC Base Unit

IDENTIFICATION

AC Adapter
110V: 725-3312
220V: 725-3327

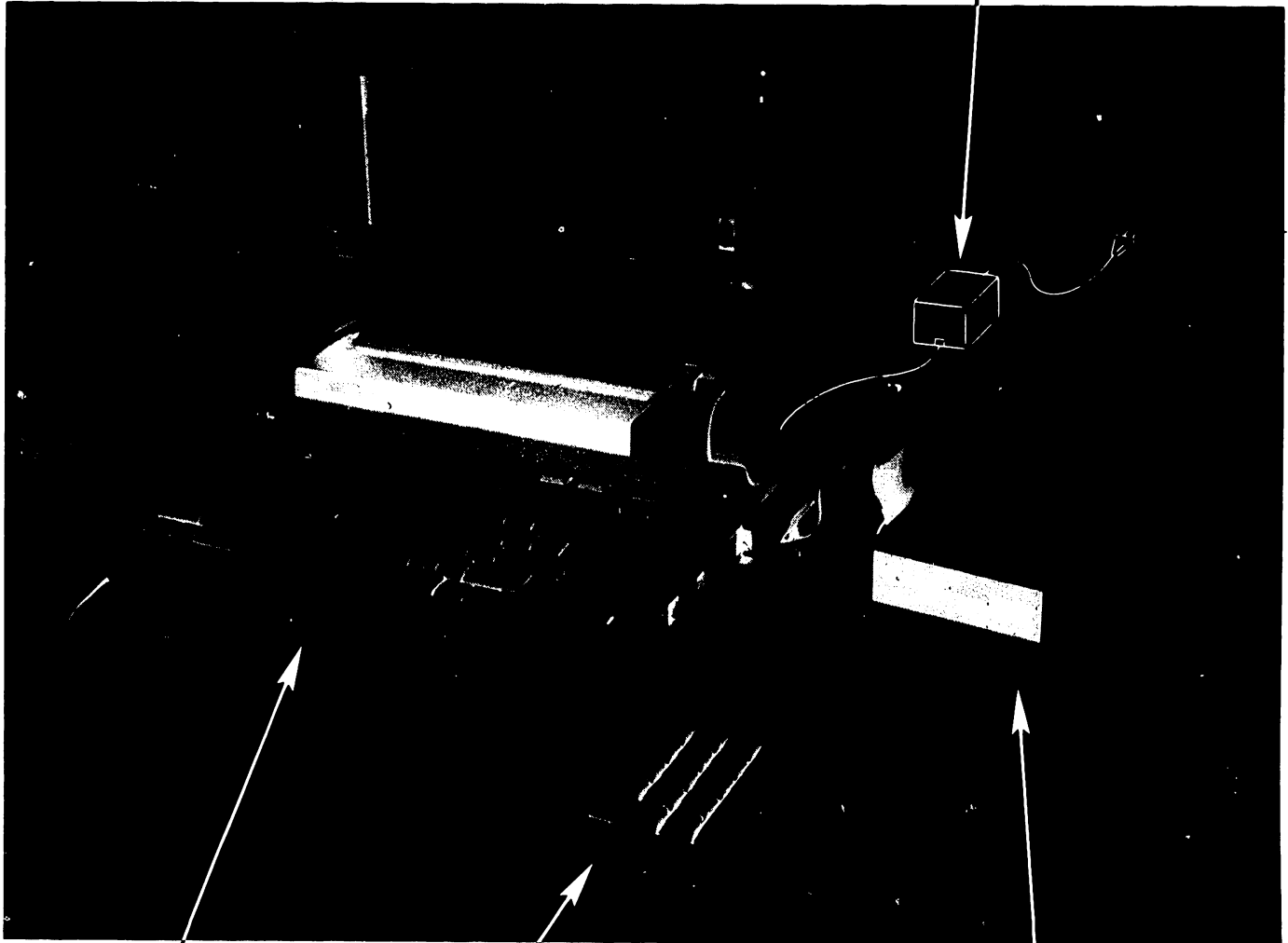

CPU

10-Key Pad Assy.
725-3315

FDD (3.5in.)

B-03423-FY87-1

2.2

WLTC Options

IDENTIFICATION

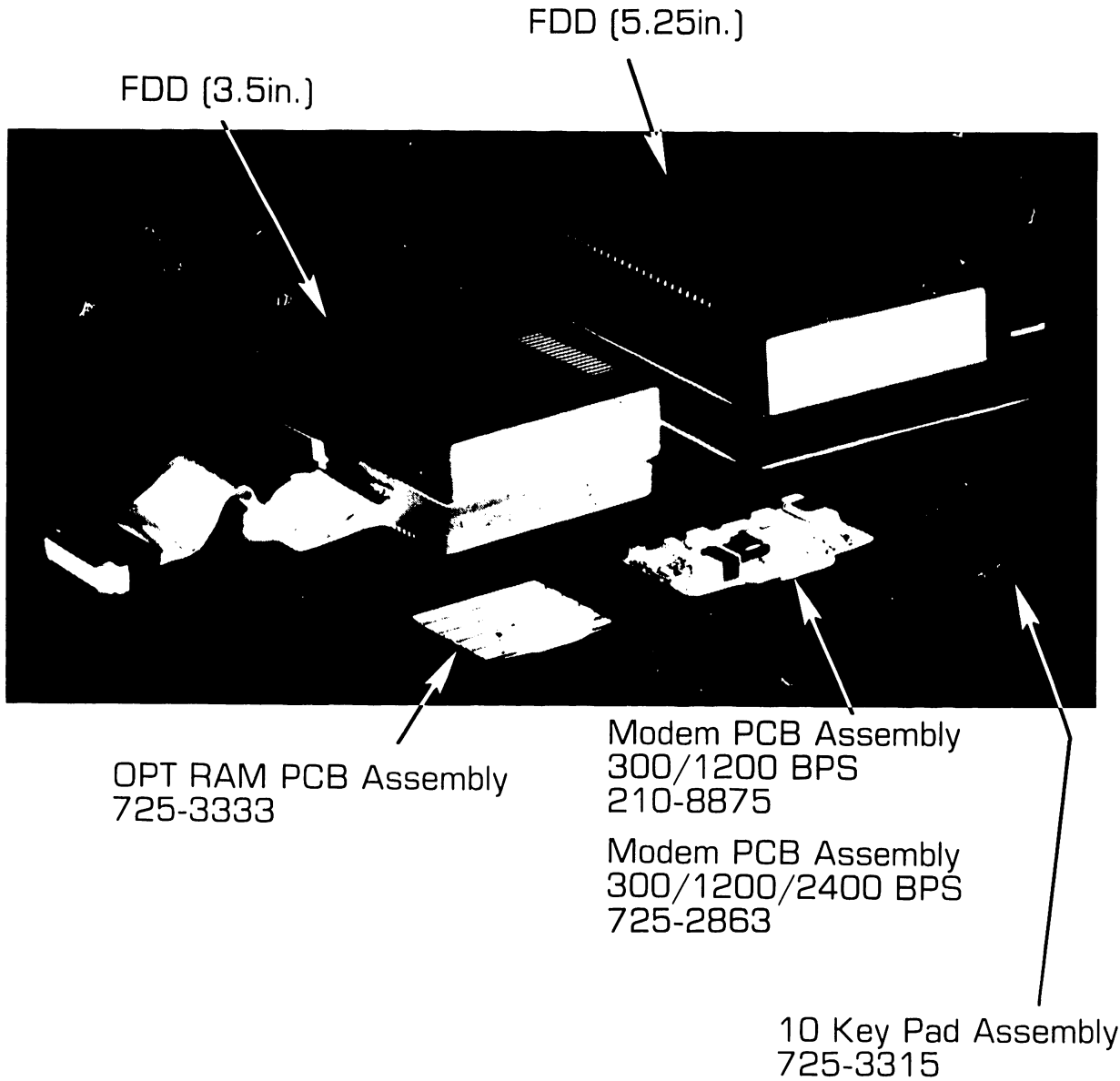

2.3

CPU

IDENTIFICATION

2.3.1

External Identification (sheet 1 of 4)

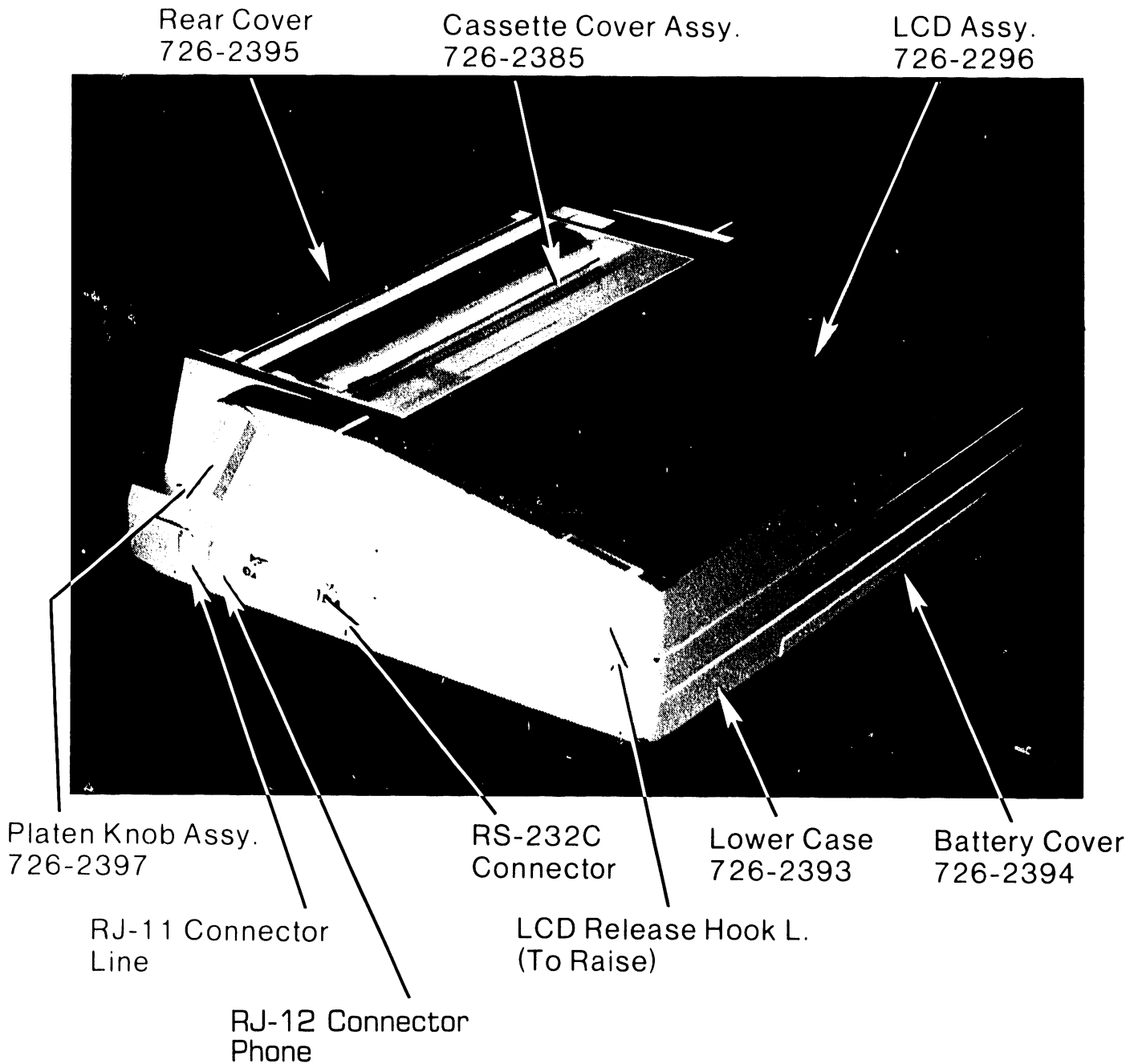

B-03423-FY87-2

▶ NEXT

2.3

CPU

IDENTIFICATION

2.3.1

External Identification (sheet 2 of 4)

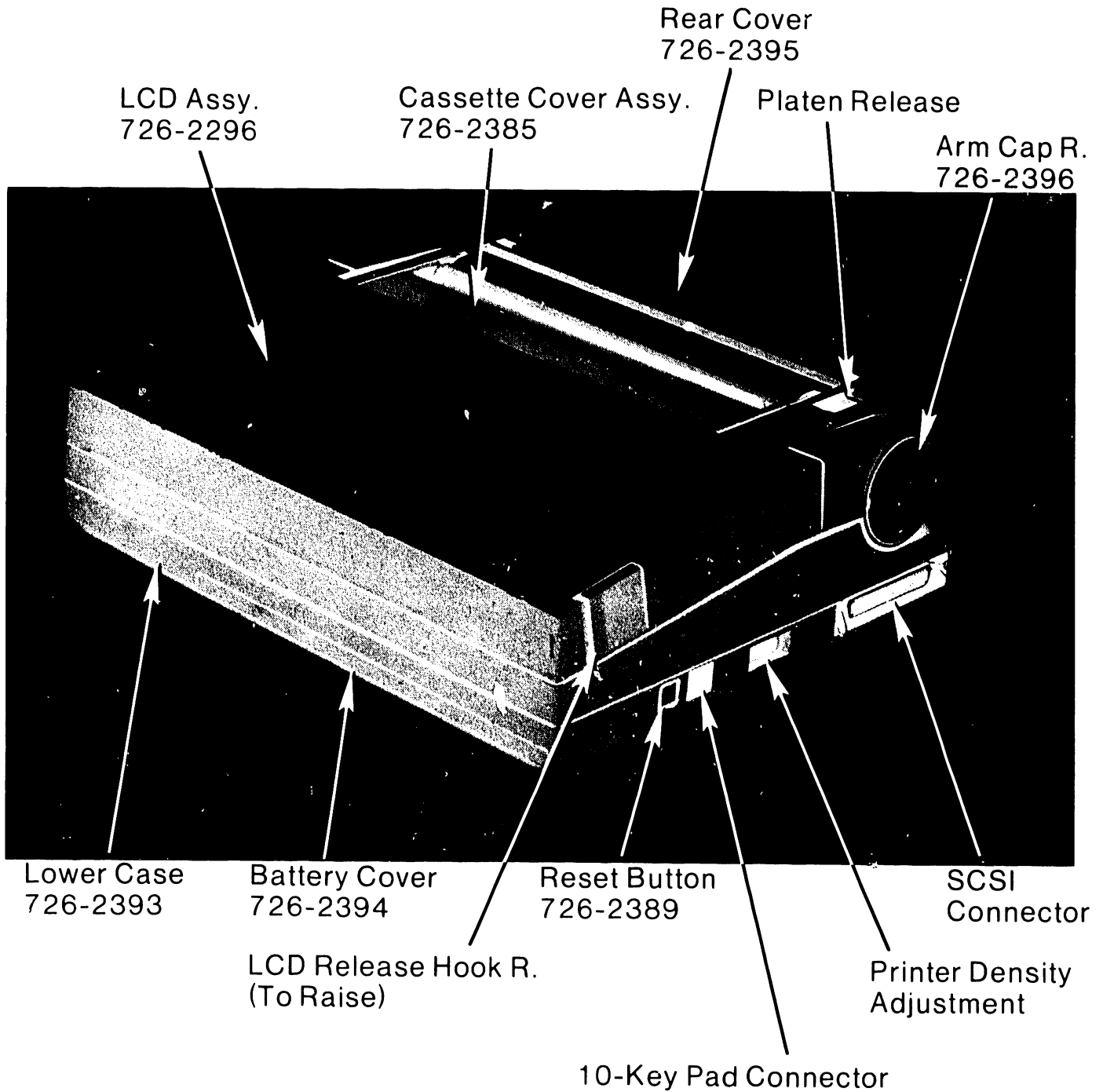

B-03423-FY87-3

▶NEXT

2.3

CPU

IDENTIFICATION

2.3.1

External Identification (sheet 3 of 4)

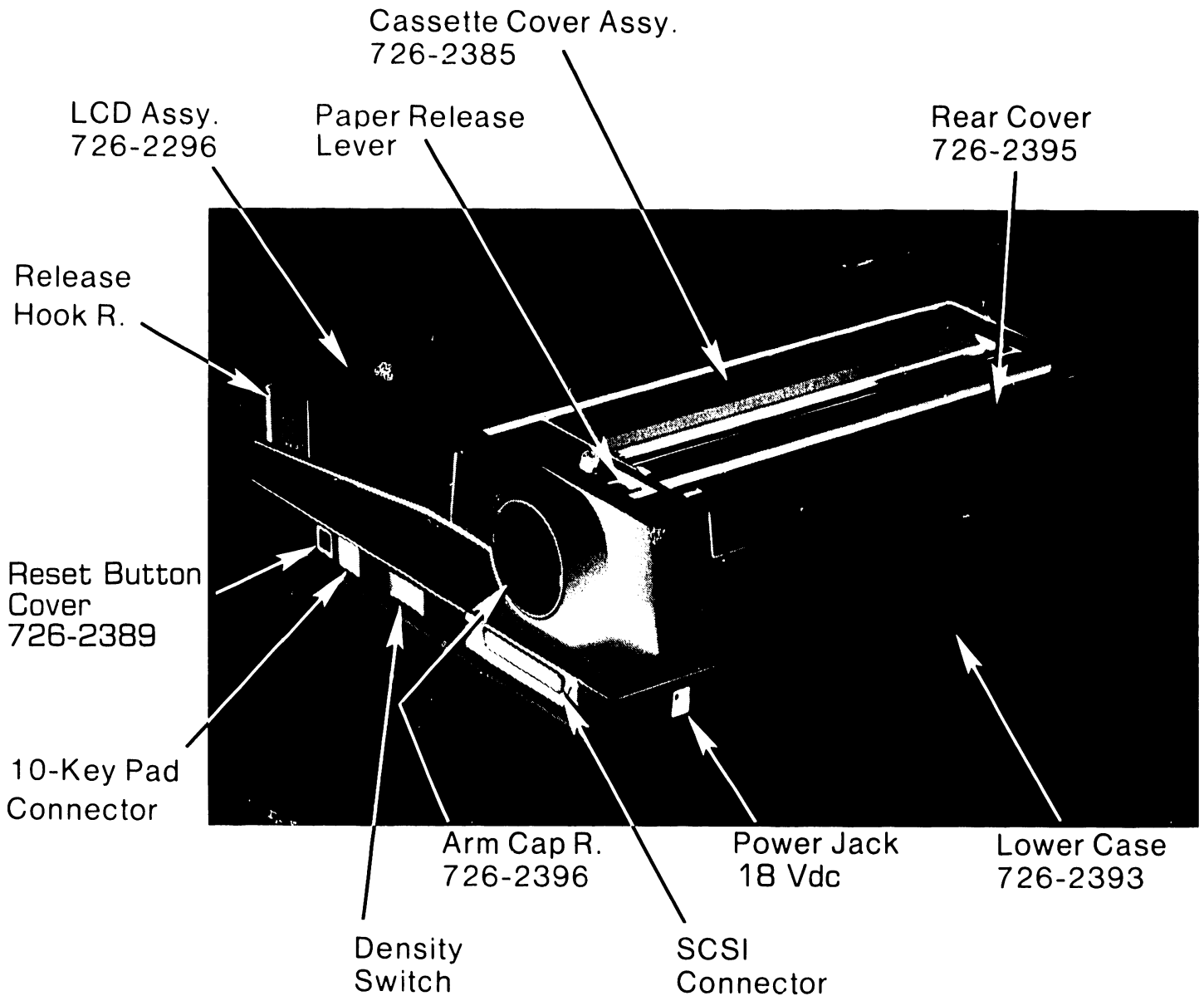

B-03423-FY87-4

▶NEXT

2.3

CPU

IDENTIFICATION

2.3.1

External Identification (sheet 4 of 4)

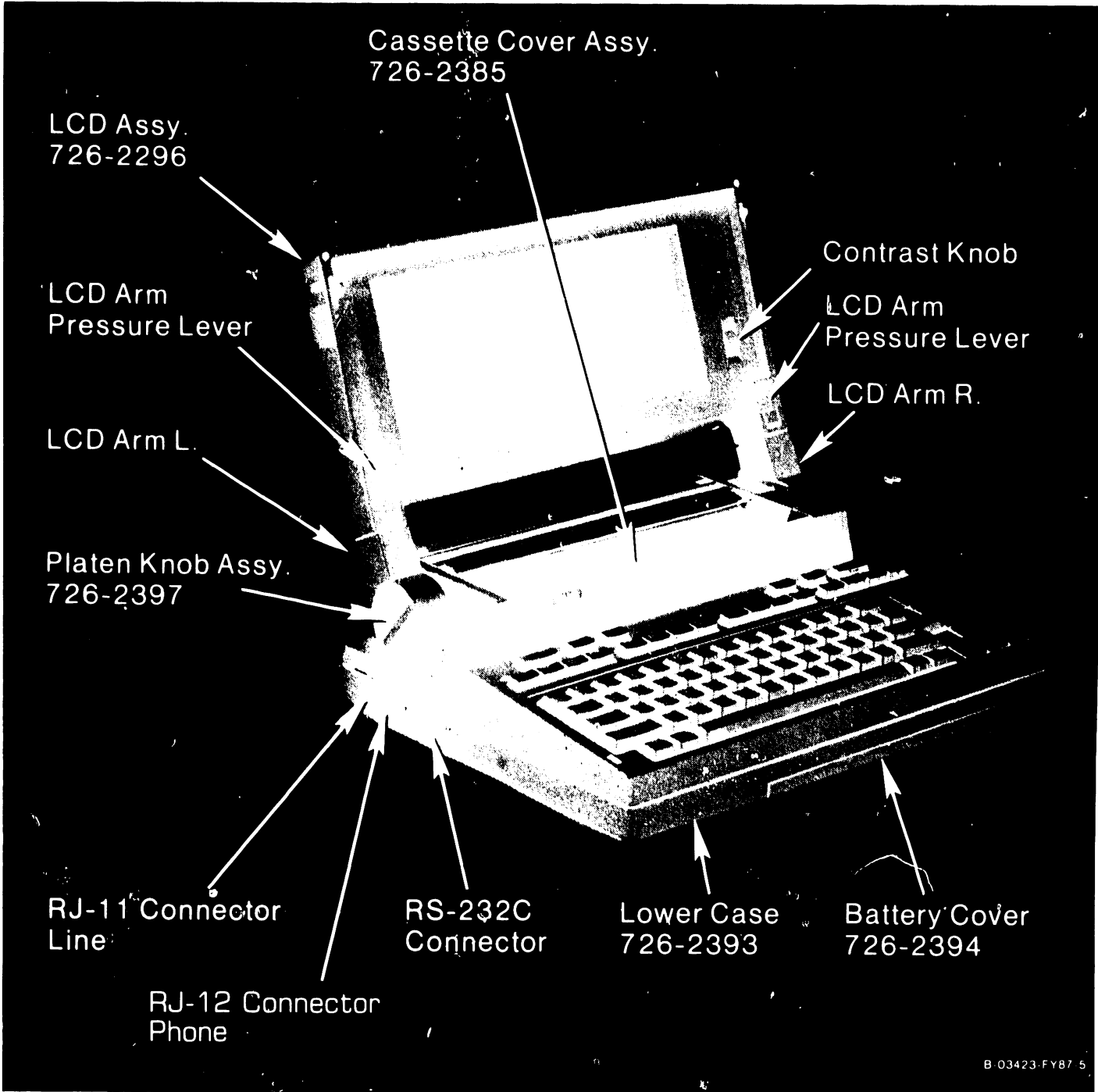

◆ END

IDENTIFICATION

2.3

CPU

2.3.2

Internal Identification - Lower Case Items (sheet 1 of 7)

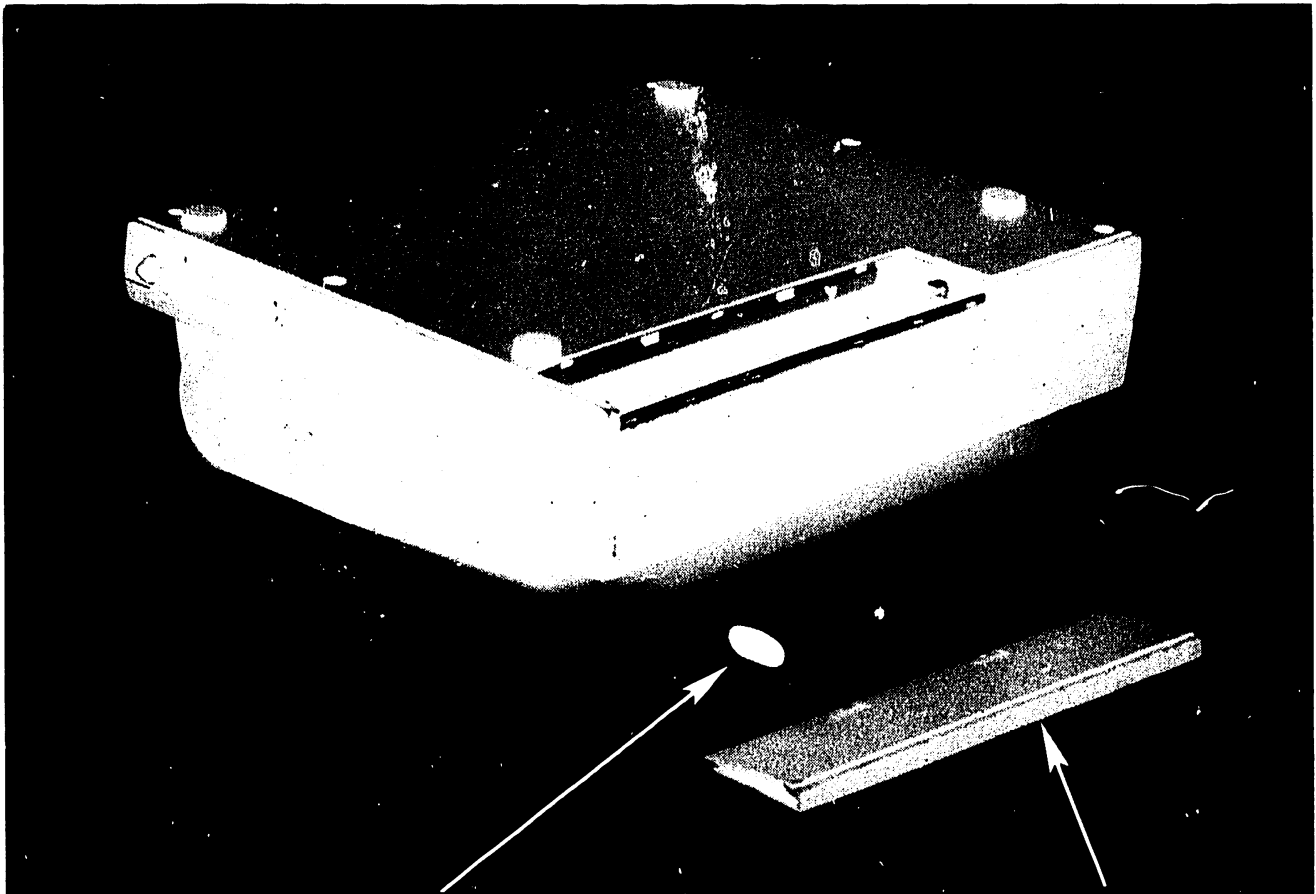

NICD Battery Assy.
725-3317

Battery Cover
726-2394

B-03423-FY87-6

▶NEXT

IDENTIFICATION

2.3

CPU

2.3.2

Internal Identification - Lower Case Items (sheet 2 of 7)

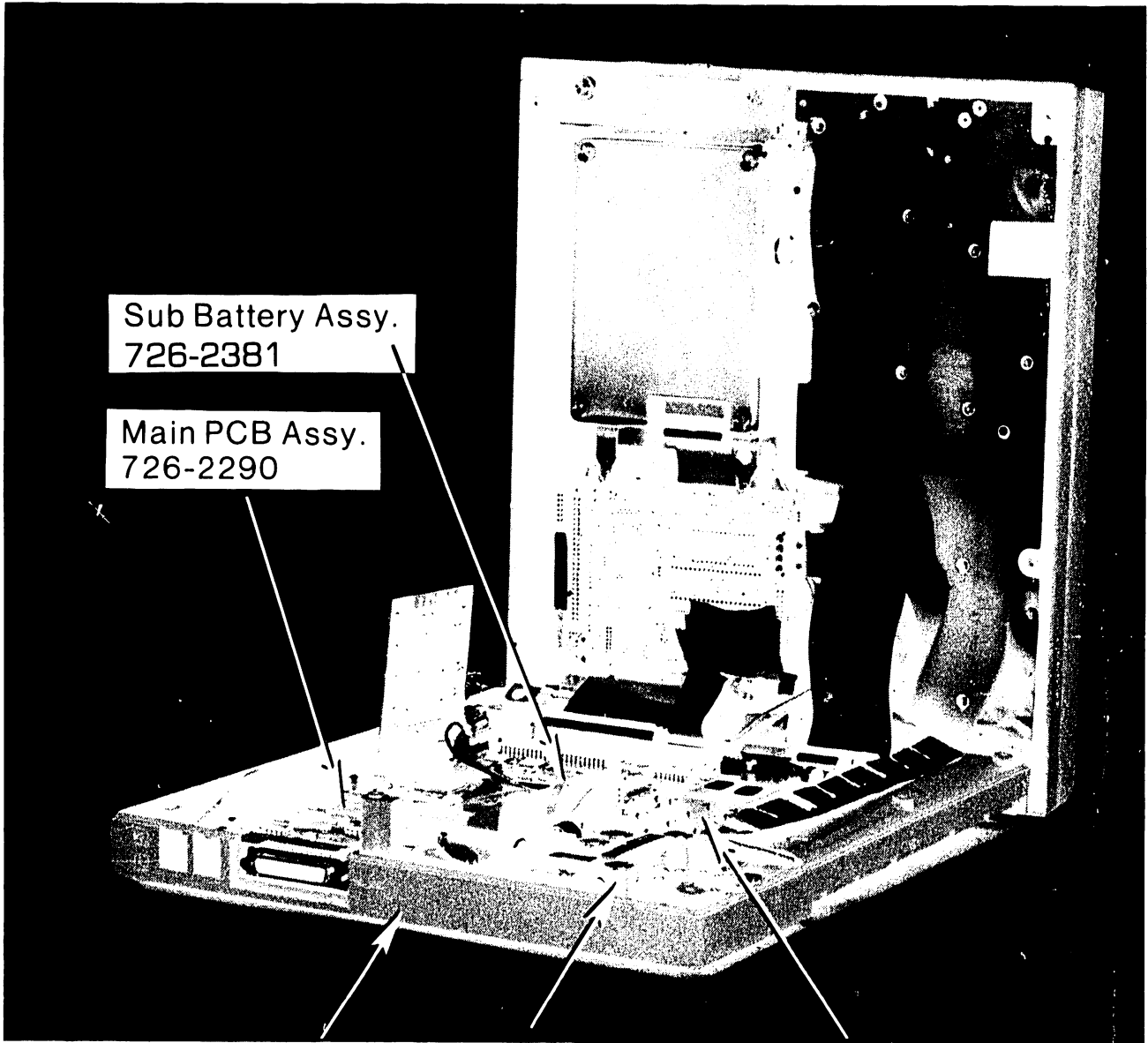

Lower Case
726-2393

Power PCB Assy.
726-2291

STD RAM PCB Assy.
726-2292

B-03423-FY87-7

▶NEXT

IDENTIFICATION

2.3

CPU

2.3.2

Internal Identification - Lower Case Items (sheet 3 of 7)

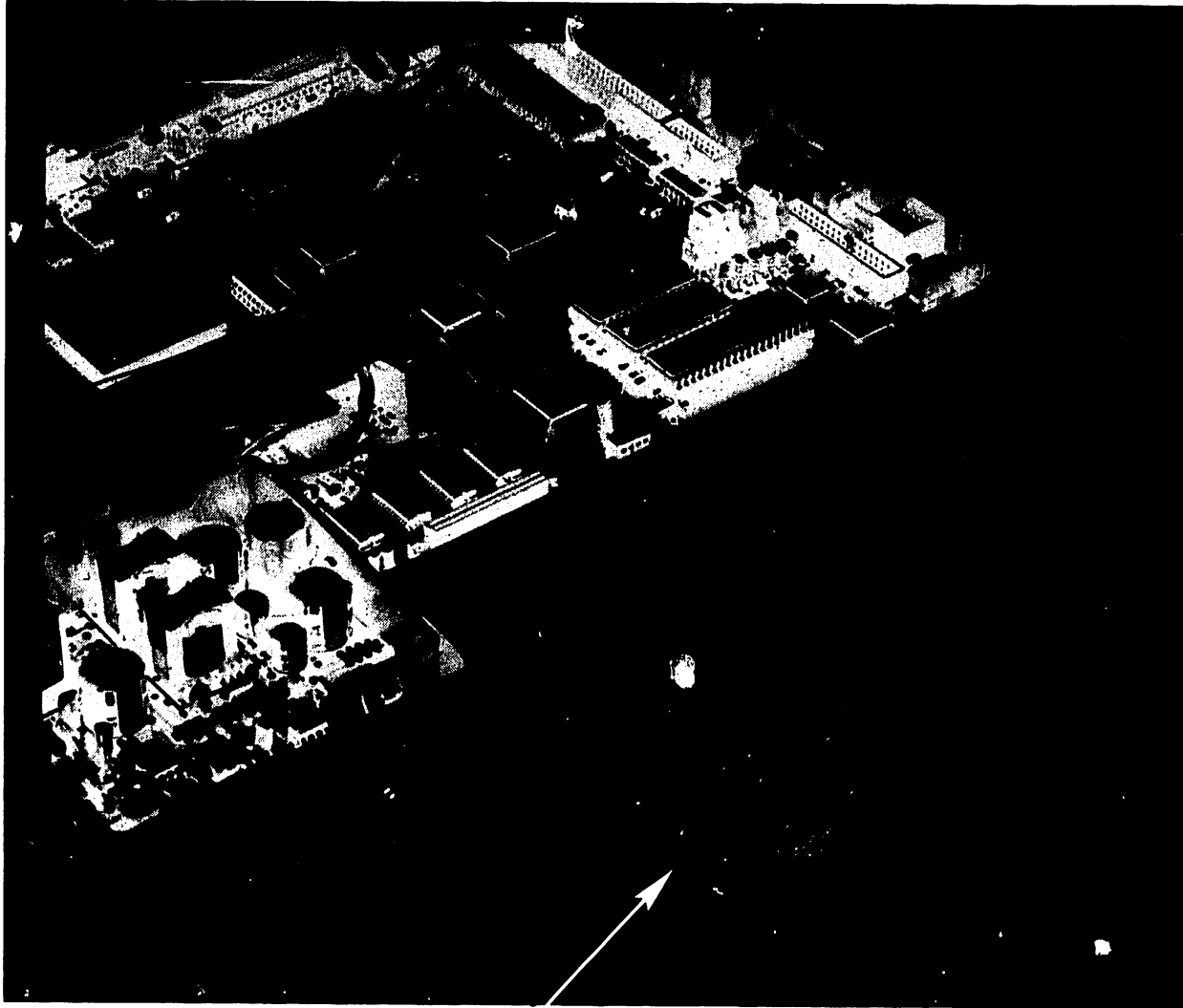

STD RAM PCB Assy.
726-2292

B-03423-FY87-8

▶ NEXT

2.3

CPU

IDENTIFICATION

2.3.2

Internal Identification - Lower Case Items (sheet 4 of 7)

Sub Battery Assy.
726-2381

Main PCB Assy.
726-2290

Lower Case
726-2393

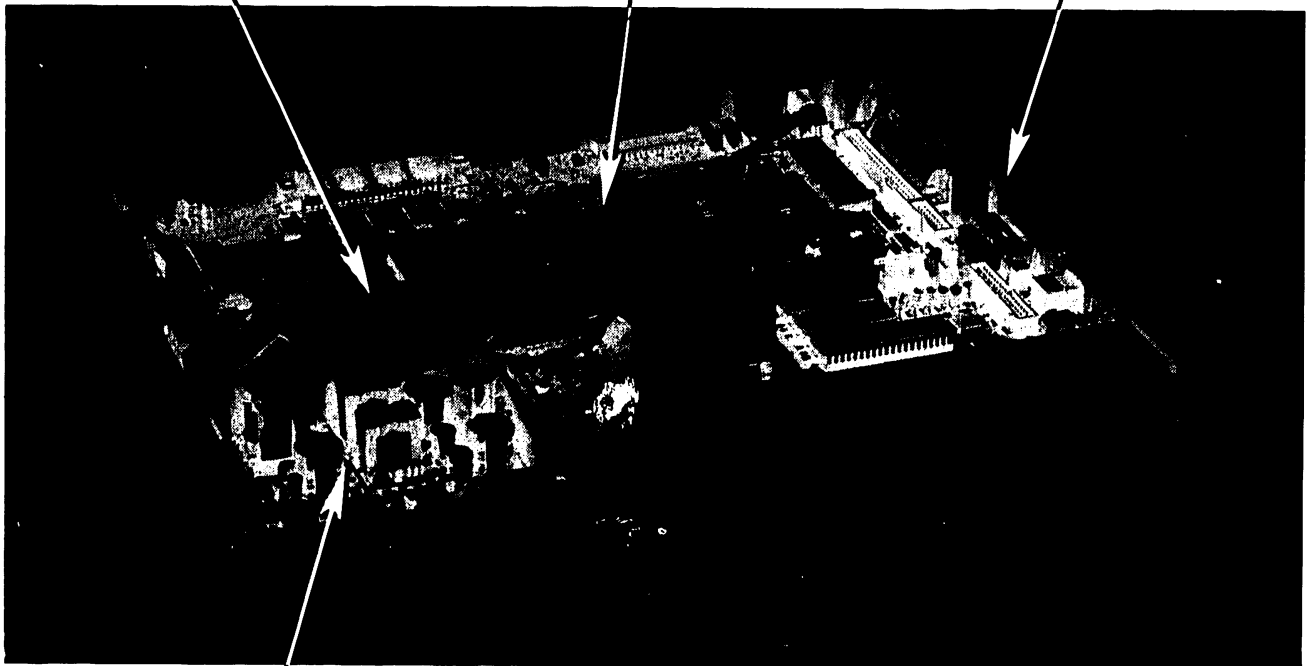

Power PCB Assy.
726-2291

B-03423-FY87-9

▶NEXT

2.3

CPU

IDENTIFICATION

2.3.2

Internal Identification - Lower Case Items (sheet 5 of 7)

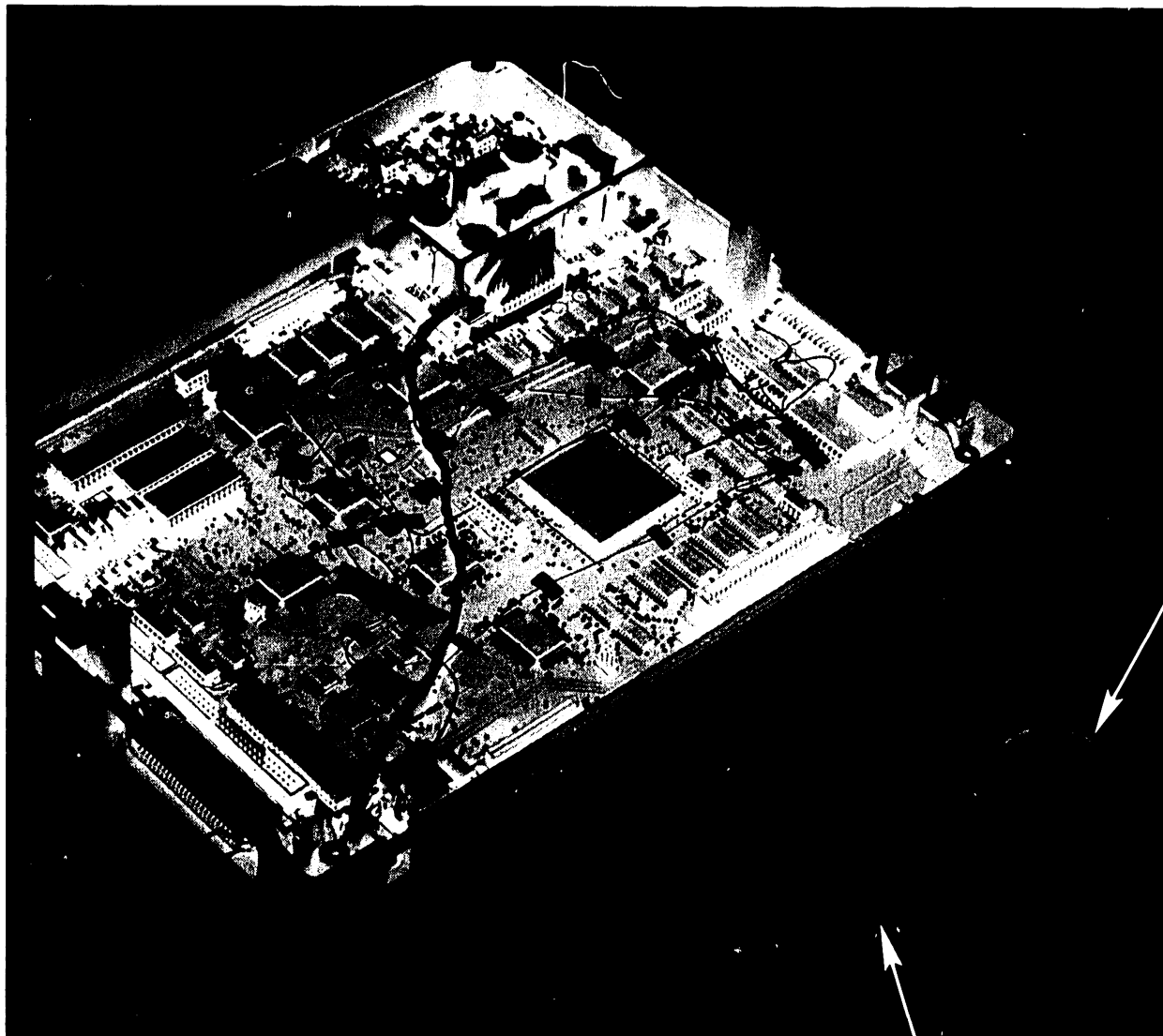

Speaker

Sub Battery Assy.
726-2381

B-03423-FY87-10

▶ NEXT

IDENTIFICATION

2.3

CPU

2.3.2

Internal Identification - Lower Case Items (sheet 6 of 7)

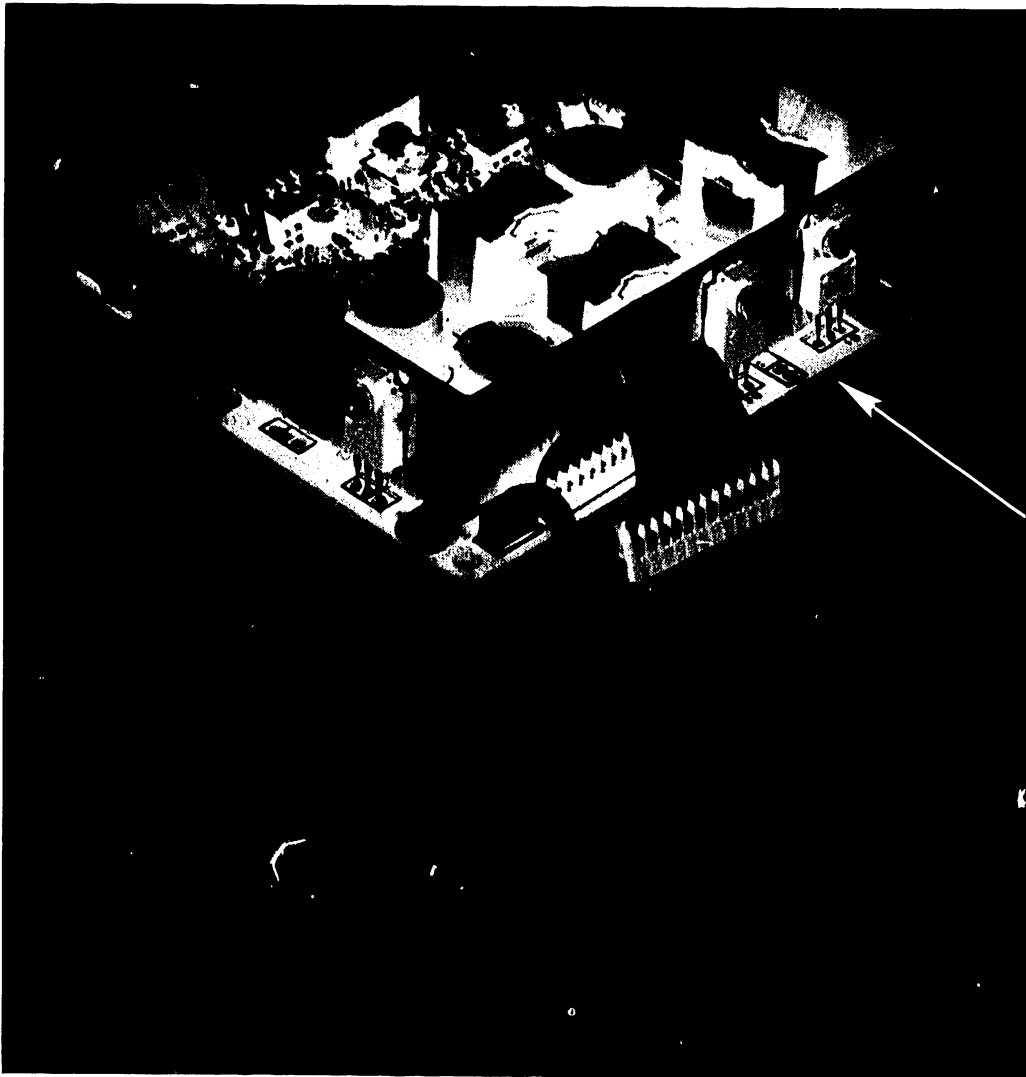

Power PCB Assy.
726-2291

B-03423-FY87-11

➡NEXT

IDENTIFICATION

2.3

CPU

2.3.2

Internal Identification - Lower Case Items (sheet 7 of 7)

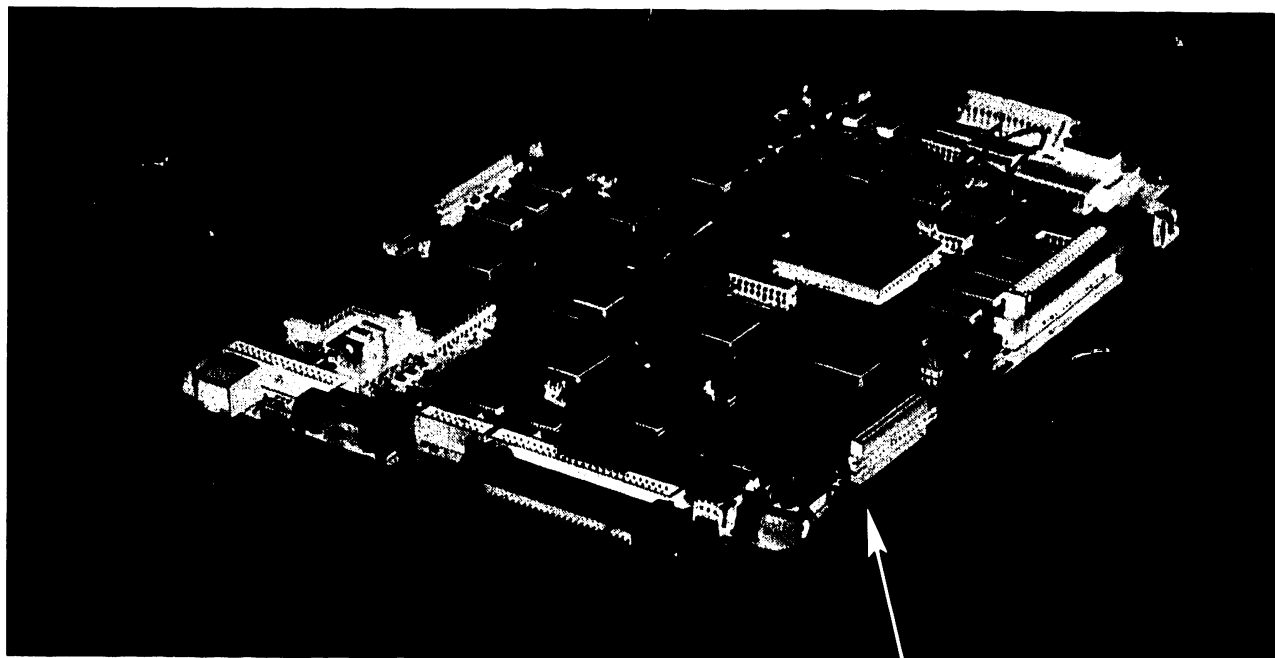

Main PCB Assy.
726-2290

B-03423-FY87-12

● END

2.3

CPU

IDENTIFICATION

2.3.3

Internal Identification - Upper Case Items (sheet 1 of 9)

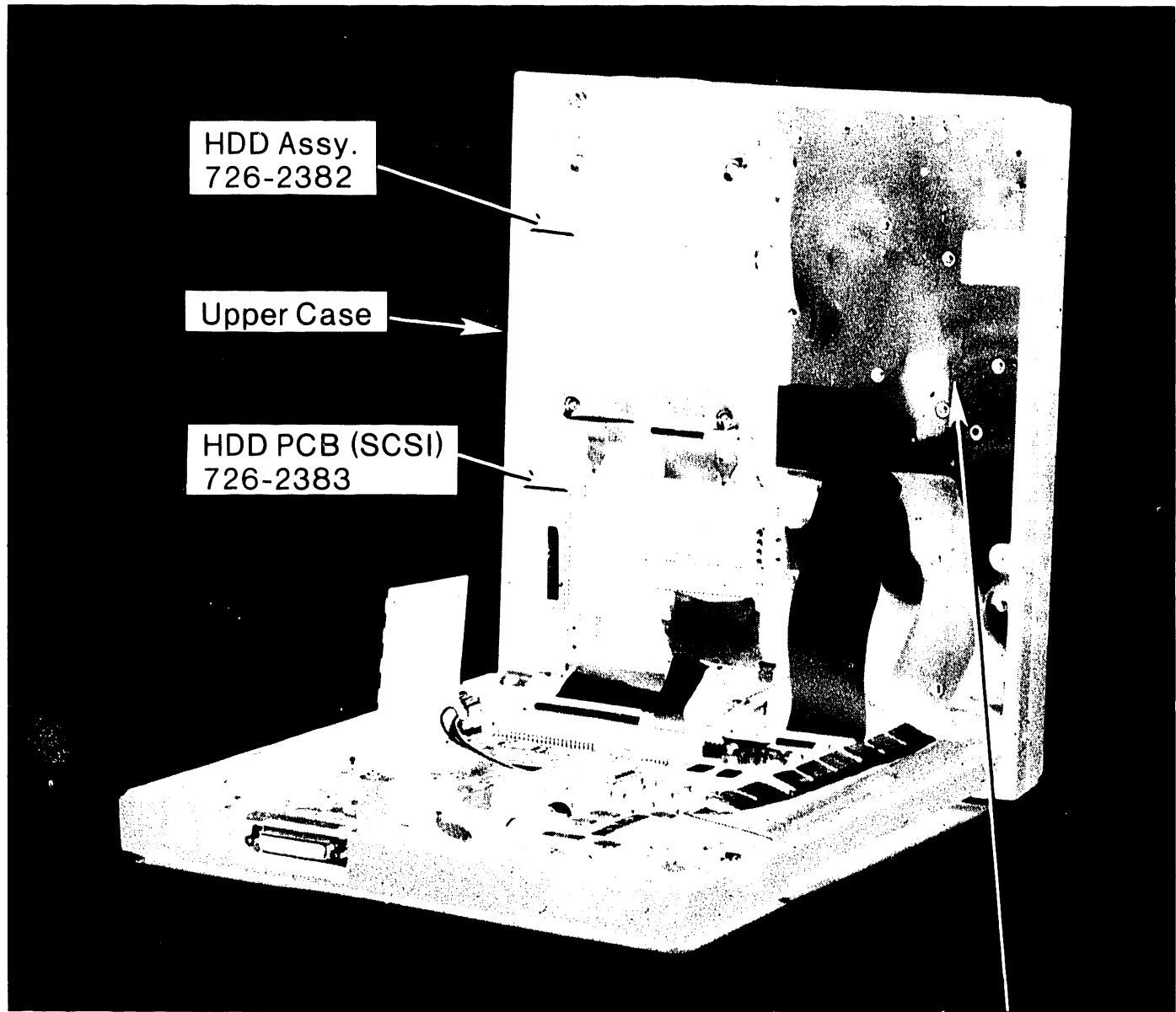

K/B Full Assy.
726-2294

B-03423-FY87-13

▶ NEXT

2.3

CPU

IDENTIFICATION

2.3.3

Internal Identification - Upper Case Items (sheet 2 of 9)

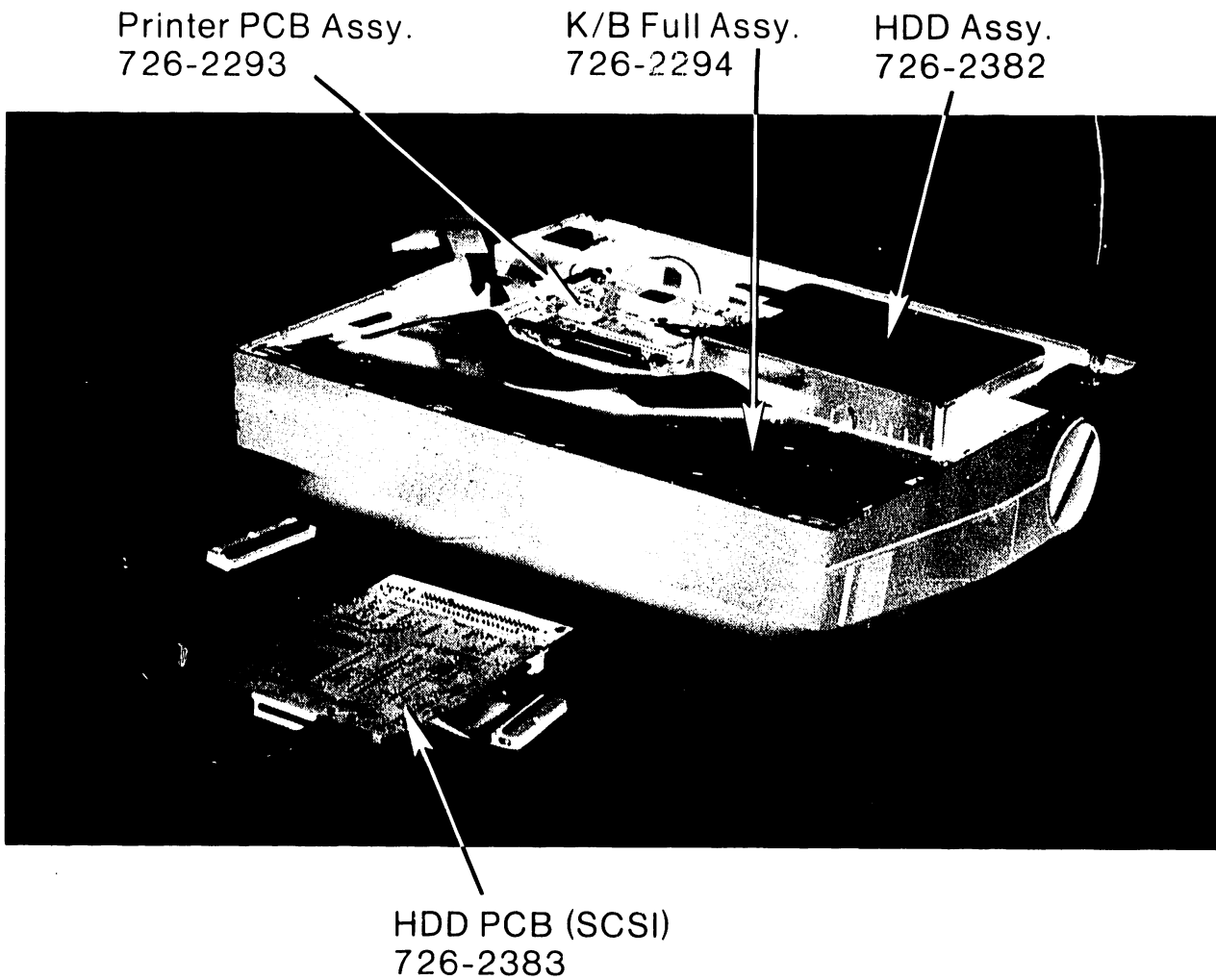

B-03423-FY87-14

▶NEXT

2.3

CPU

IDENTIFICATION

2.3.3

Internal Identification - Upper Case Items (sheet 3 of 9)

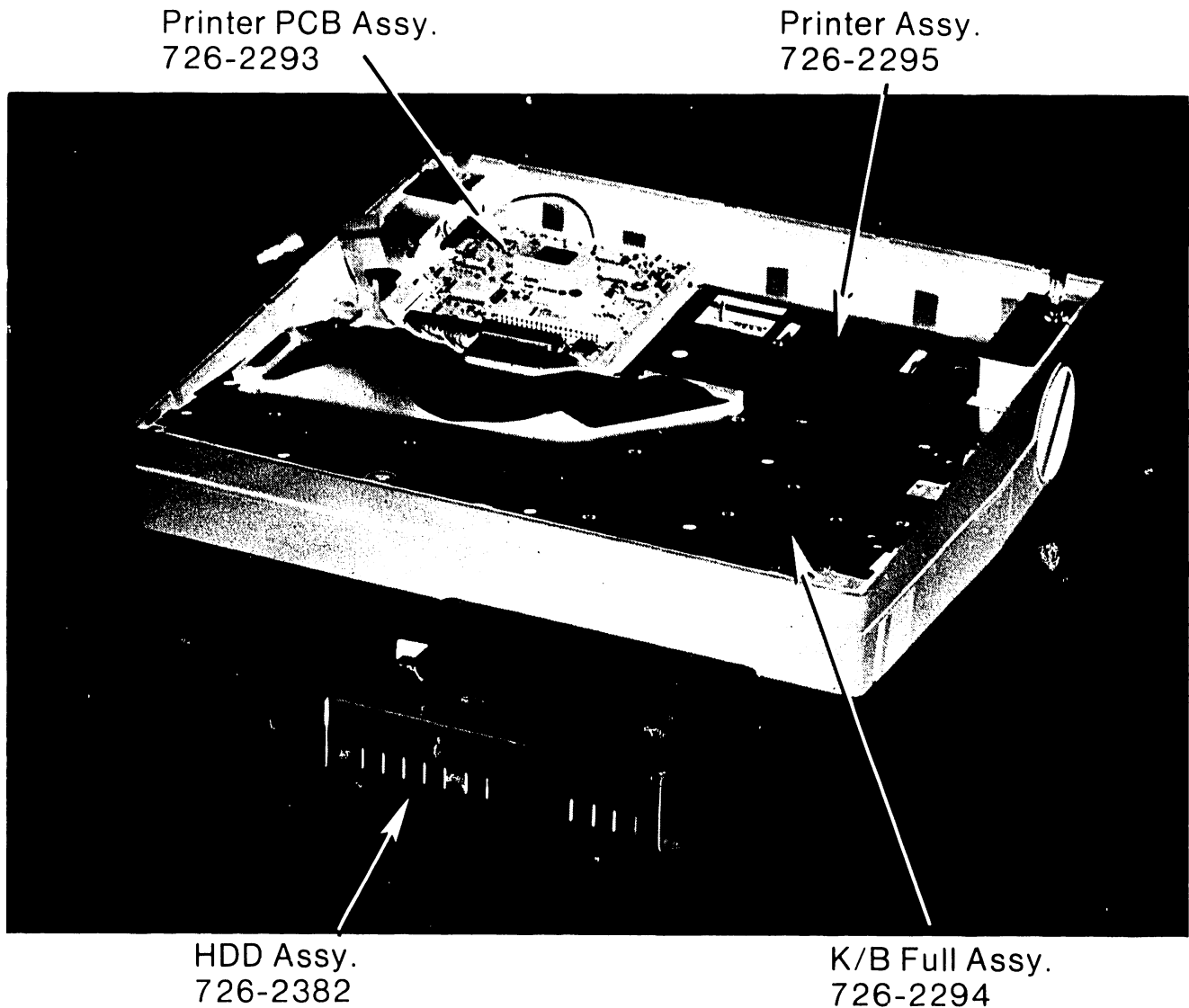

B-03423-FY87-15

▶NEXT

2.3

CPU

IDENTIFICATION

2.3.3

Internal Identification - Upper Case Items (sheet 4 of 9)

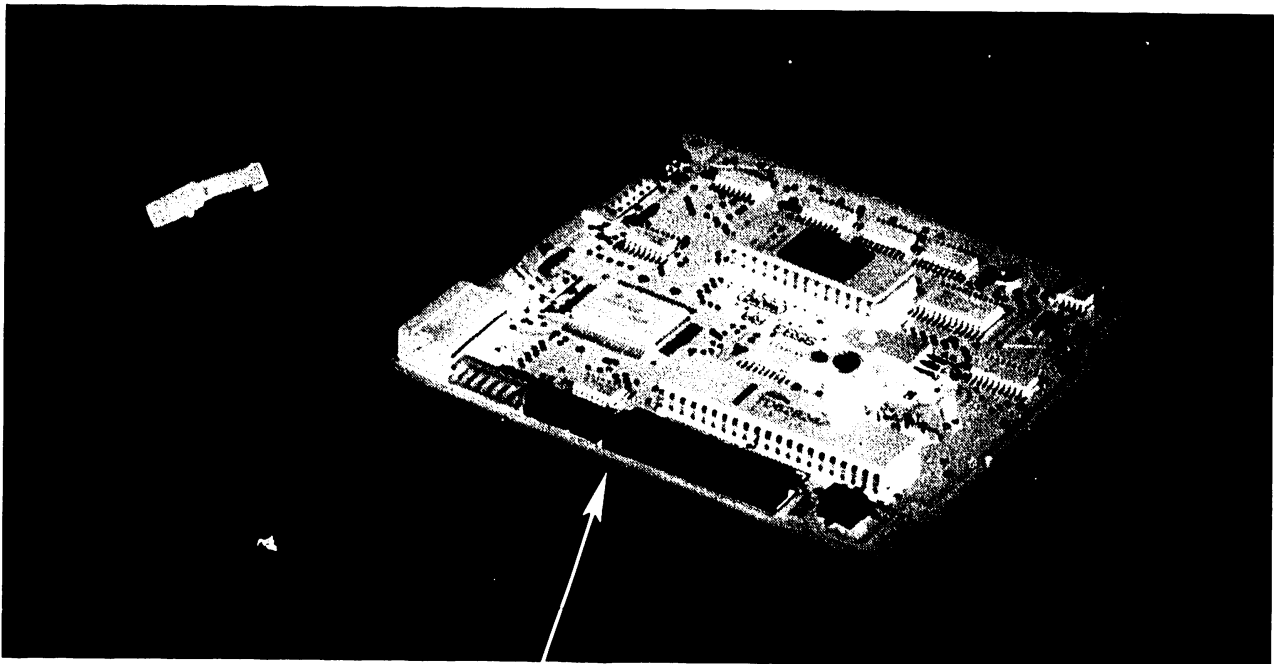

Printer PCB Assy.
726-2293

B-03423-FY87-16

▶NEXT

2.3

CPU

IDENTIFICATION

2.3.3

Internal Identification - Upper Case Items (sheet 5 of 9)

Printer Assy.
726-2295

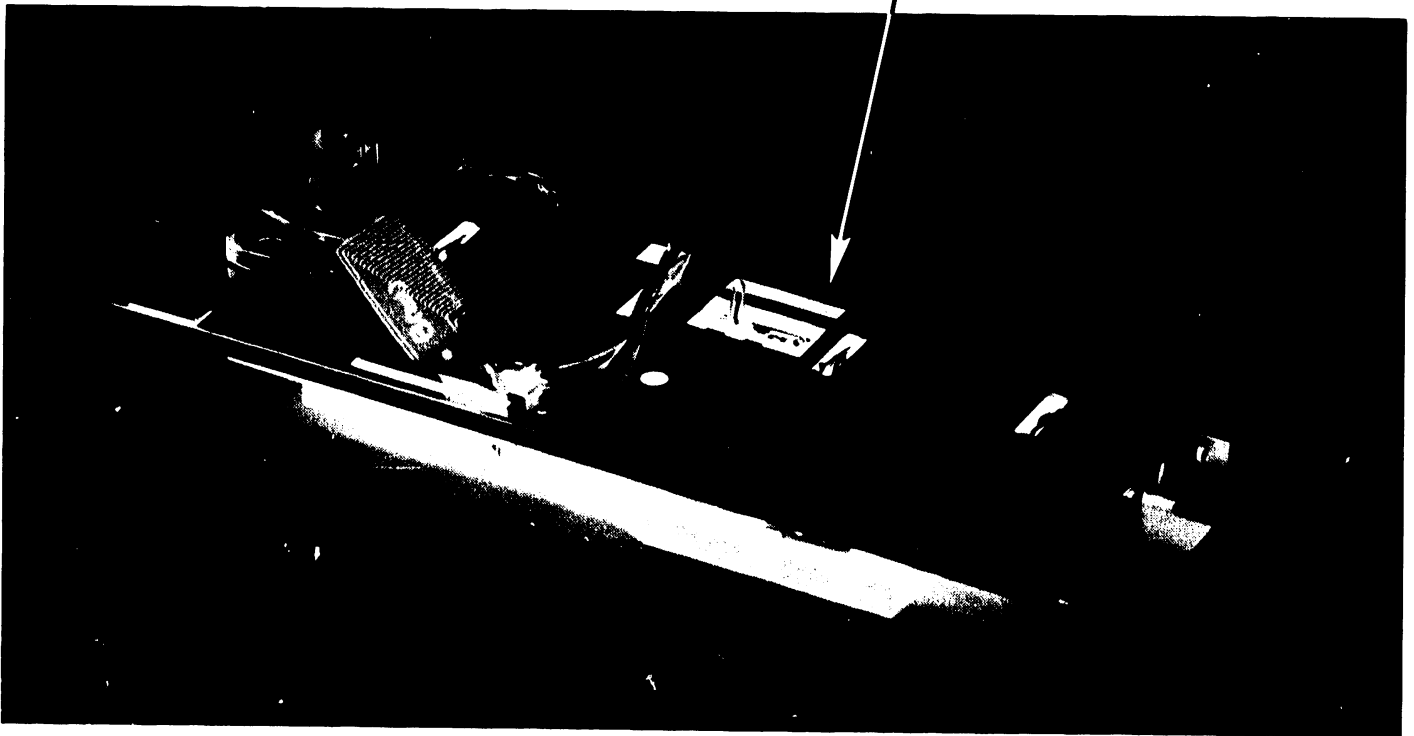

B-03423-FY87-17

▶NEXT

IDENTIFICATION

2.3

CPU

2.3.3

Internal Identification - Upper Case Items (sheet 6 of 9)

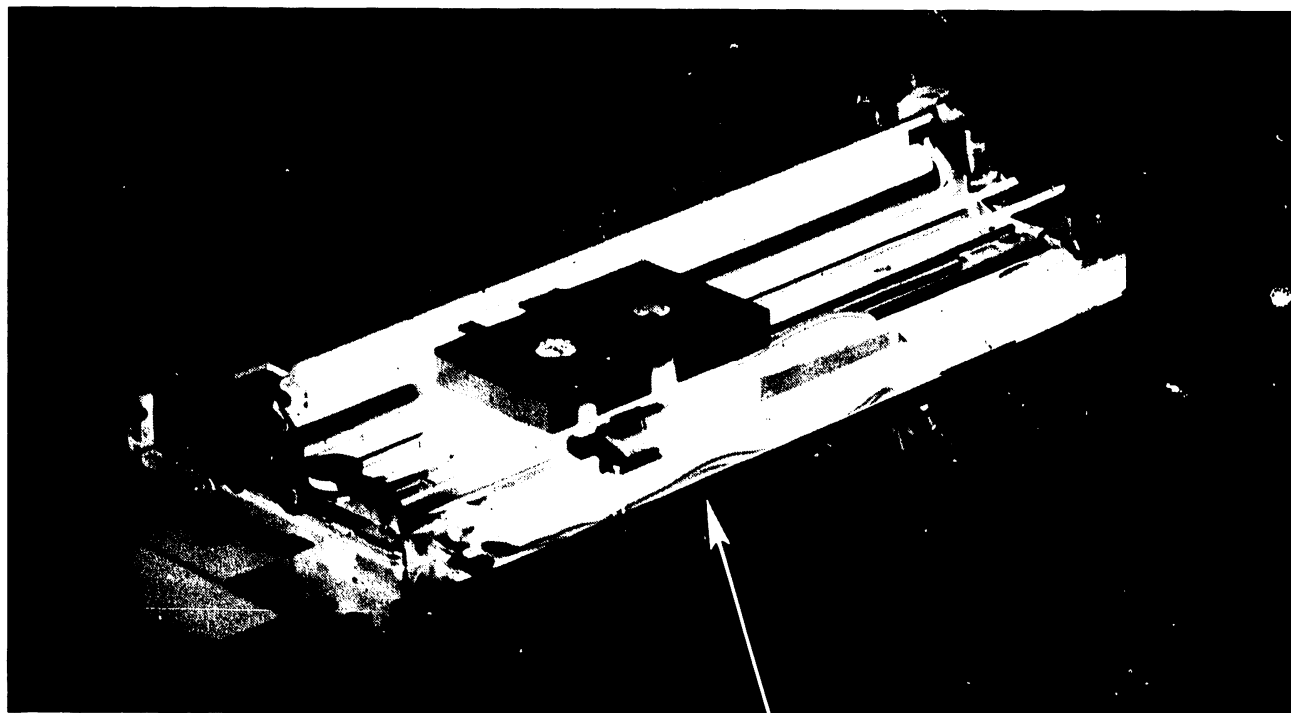

Printer Assy.
726-2295

B-03423-FY87-18

▶NEXT

2.3

CPU

IDENTIFICATION

2.3.3

Internal Identification - Upper Case Items (sheet 7 of 9)

Rear Cover
726-2395

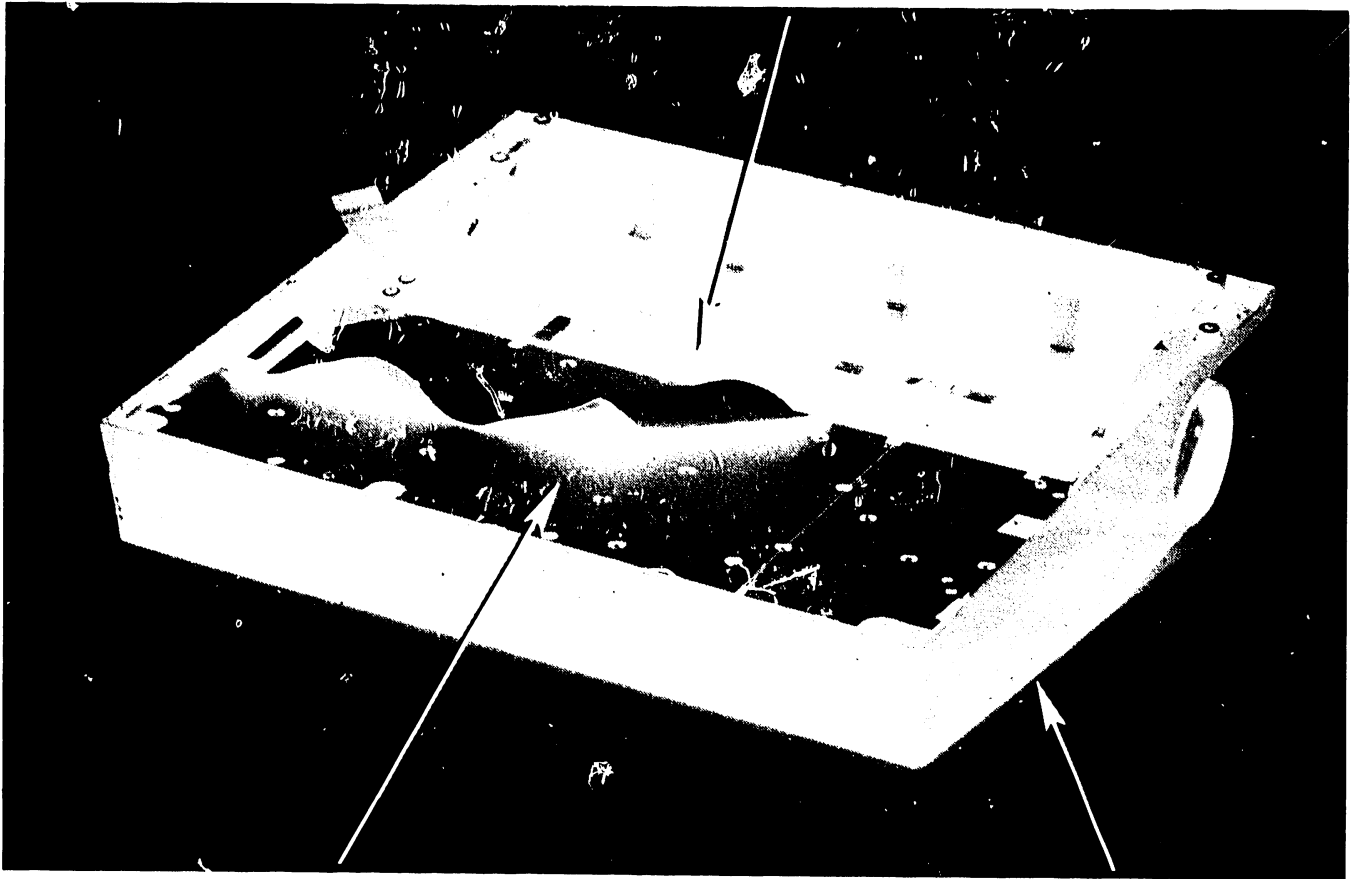

K/B Full Assy.
726-2294

LCD Assy.
726-2296

B-03423-FY87-19

▶NEXT

IDENTIFICATION

2.3

CPU

2.3.3

Internal Identification - Upper Case Items (sheet 8 of 9)

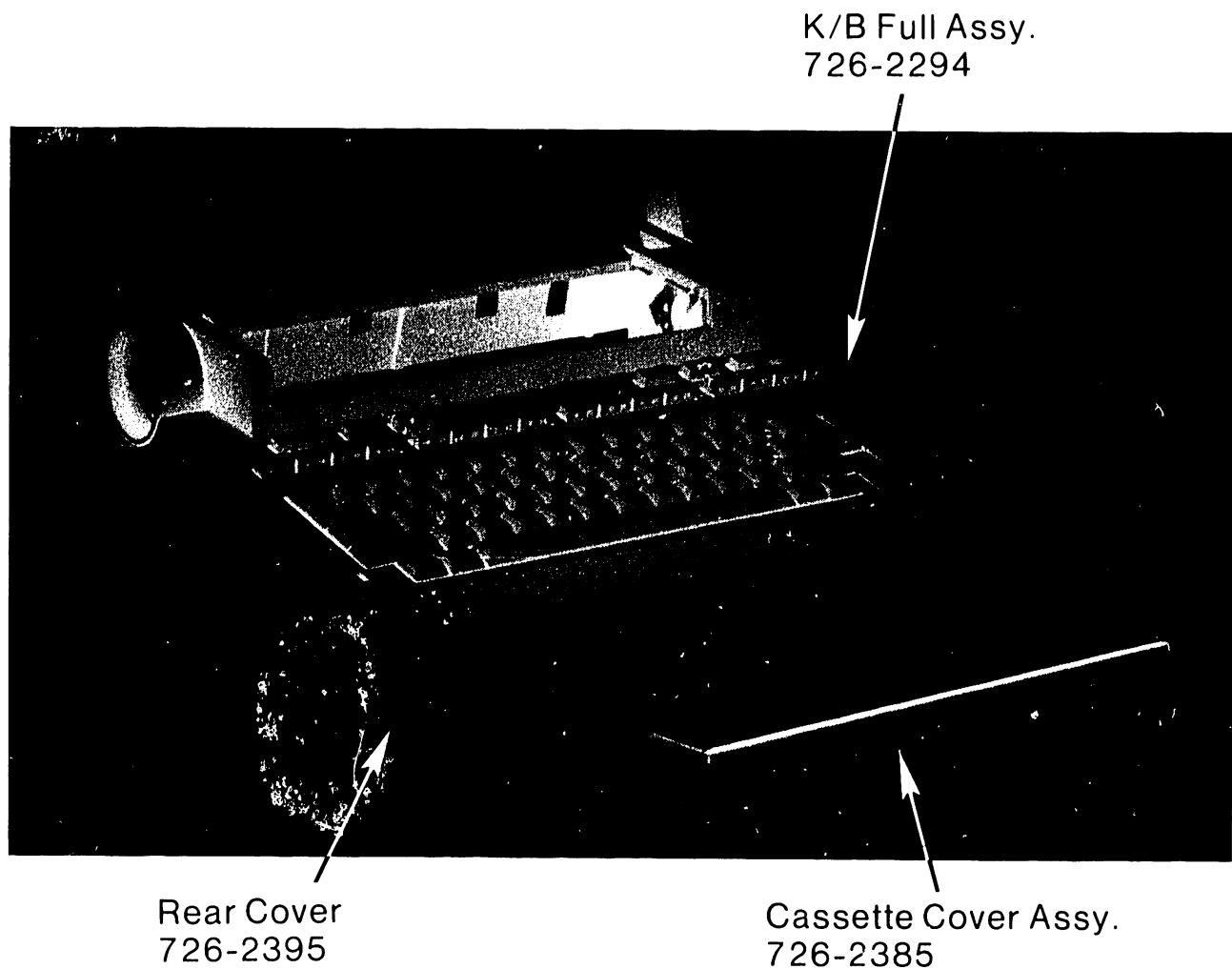

B-03423-FY87-20

▶NEXT

2.3

CPU

IDENTIFICATION

2.3.3

Internal Identification - Upper Case Items (sheet 9 of 9)

LCD Arm
Pressure Plate

LCD Arm
Pressure Plate

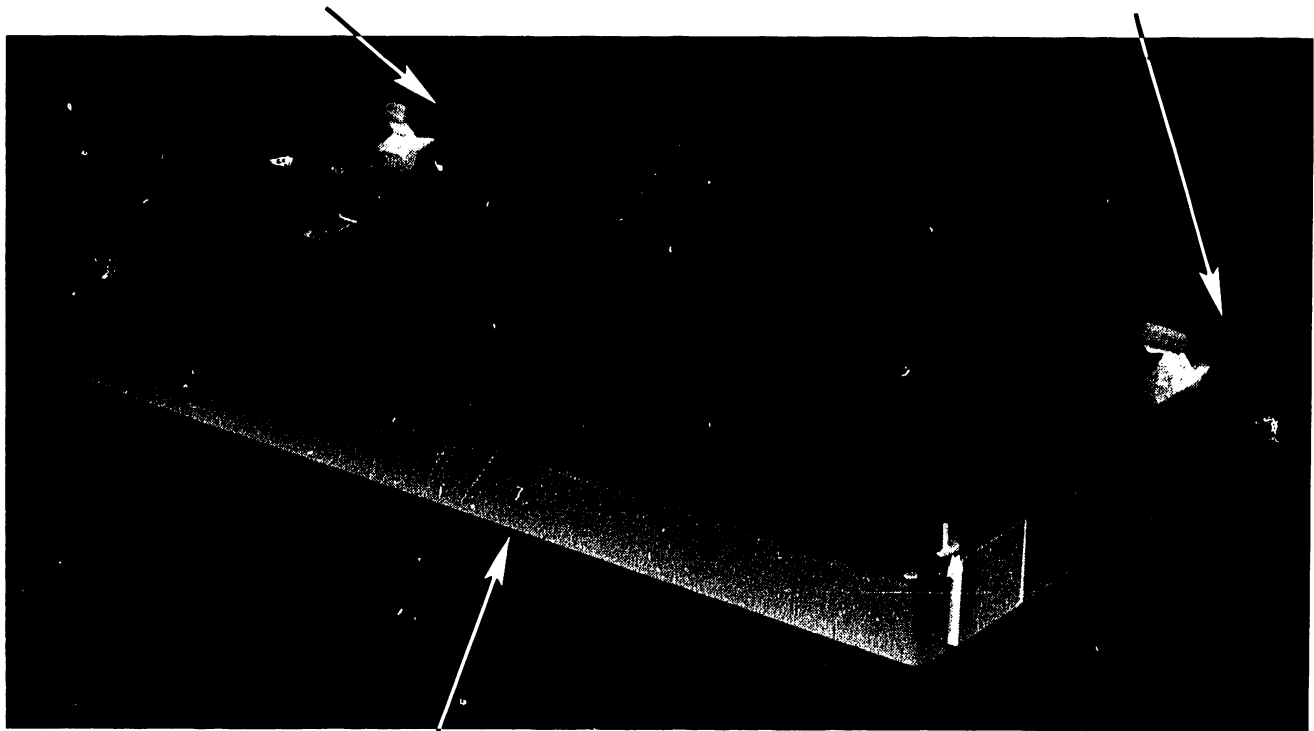

LCD Assy.
726-2296

B-03423-FY87-21

◆ END

SECTION
3
CONTROLS
AND
INDICATORS

SECTION 3 CONTENTS

SECTION 3 CONTROLS AND INDICATORS

	Page
3.1 OPERATOR CONTROLS	3-1
3.2 OPERATOR INDICATORS	3-3
3.3 SERVICE CONTROLS	3-4
3.4 SERVICE INDICATORS	3-5
3.4.1 Voltage Test Points, CPU	3-5
3.4.2 Voltage Test Points, 3.5-inch FDD	3-6
3.4.3 Voltage Test Points, 5.25-inch FDD	3-7
3.5 OPERATOR CONTROLS, 5.25-INCH FDD	3-8

3.1

CONTROLS & INDICATORS

Operator Controls (Sheet 1 of 2)

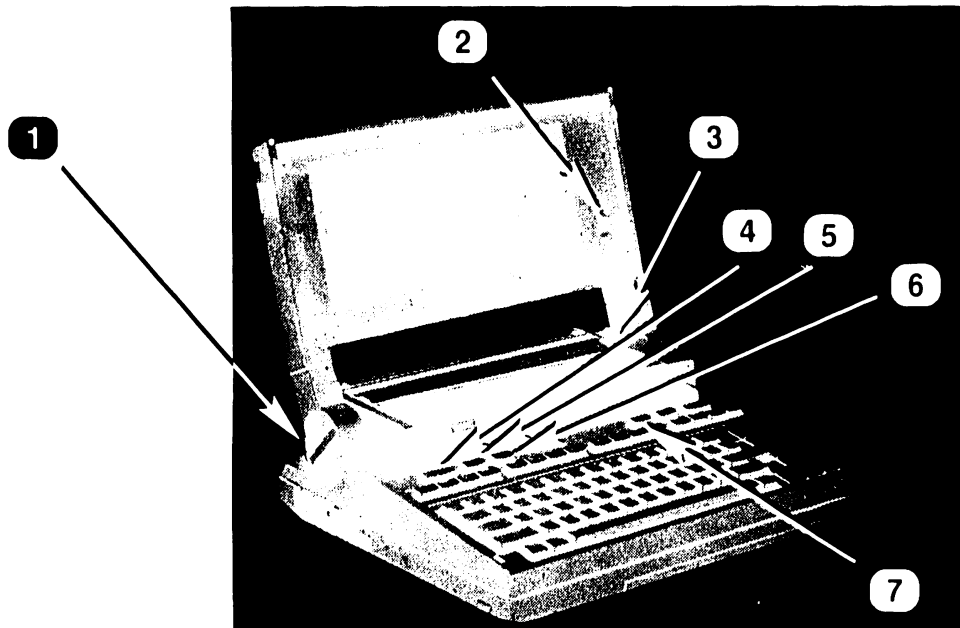

<i>Item</i>	<i>Name</i>	<i>Type and Function</i>
1	Platen Knob	Twist Knob; manually advances, or reverses, paper into printer.
2	Contrast	Thumbwheel; adjusts LCD contrast.
3	Platen Release	Lever; releases platen pressure so that paper may be adjusted.
4	HELP	Typewriter-style key; with some software, invokes explanations of menu selections, functions, and commands.
5	PAPER BACK	Typewriter-style key; reverses paper into printer, use simultaneously with PAPER IN to select and deselect printer.
6	PAPER IN	Typewriter-style key; advances paper into printer, use simultaneously with PAPER BACK to select and deselect printer.
7	PRINT	Typewriter-style key; prints WP document while displayed on screen.

►NEXT

3.1

CONTROLS & INDICATORS

Operator Controls (Sheet 2 of 2)

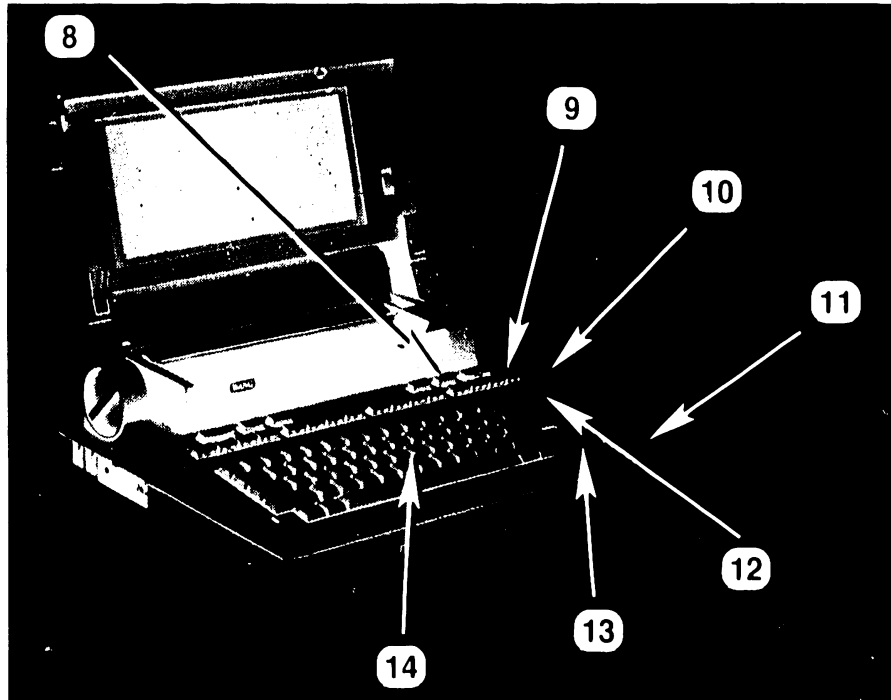

<i>Item</i>	<i>Name</i>	<i>Type and Function</i>
8	ERASE	Typewriter-style key; erases damaged screen display and replaces it with refreshed display.
9	Function Keys	Typewriter-style keys; programmable for single-stroke commands, invoke some editing functions for Wang word processing.
10	Printer Density	Slide switch, 3-position; deselects printer, selects lighter printing, or selects darker printing.
11	Reset	Pushbutton; turns WLTC on (starts B.I.T. and loads system software) and off.
12	Editing Keys	Typewriter-style keys; invoke some editing functions for Wang word processing.
13	Cursor Control Keys	Repeater typewriter-style keys; position cursor display.
14	QWERTY Keyboard	Typewriter-style keys; input keystrokes to computer.

● END

3.2

CONTROLS & INDICATORS

Operator Indicators

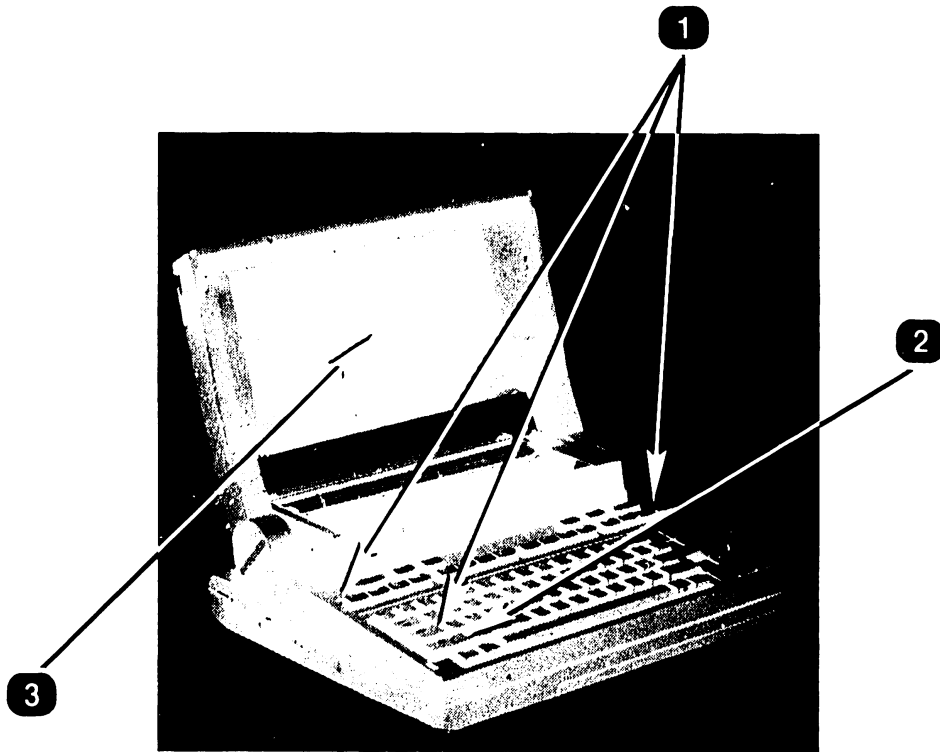

<i>Item</i>	<i>Name</i>	<i>Type and Function</i>
1	Keyboard LEDs	LEDs (green); display B.I.T. error codes (► 6.2.4).
2	LOCK	LEDs (green); indicators shift to upper case is locked.
3	Display	LCD; displays messages, text, etc.

3.3

CONTROLS & INDICATORS

Service Controls

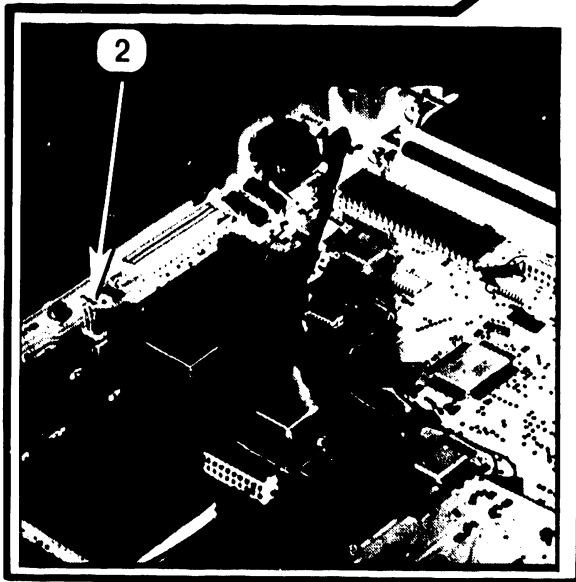

<i>Item</i>	<i>Name</i>	<i>Type and Function</i>
1	Various	Operator Controls; (▶ 3.2).
2	P12	Header and shunting jumpers; sets B.I.T. modes (▶ 6.2.2).

3.4

CONTROLS & INDICATORS

Service Indicators

3.4.1 Voltage Test Points, CPU

Bare-copper voltage test points are provided on POWER PCB ASSY. Voltages are not adjustable.

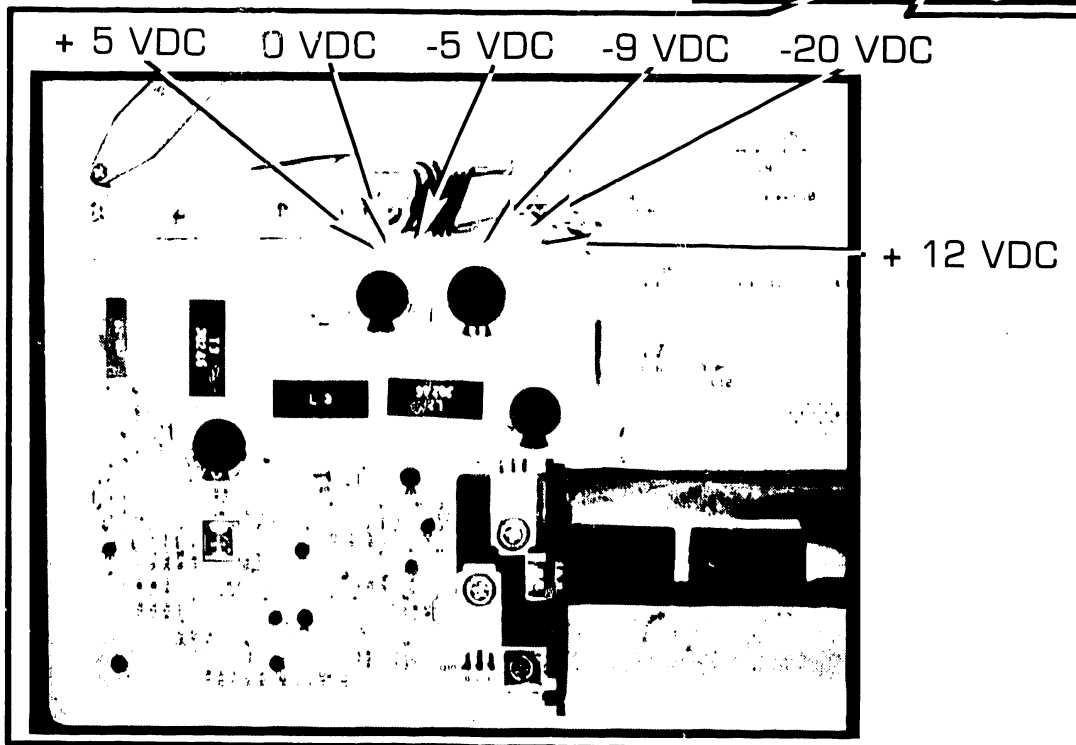
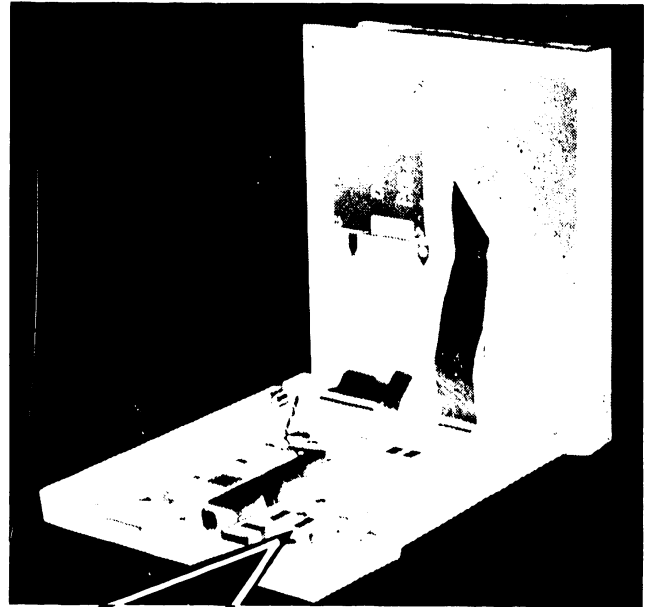

3.4

CONTROLS & INDICATORS

Service Indicators

3.4.2

Voltage Test Points, 3.5-inch FDD

Test points are not provided for the 3.5-inch FDD. Measure POWER PCB voltages on connector CN3; carefully probe into *side* of connector. Voltages are not adjustable.

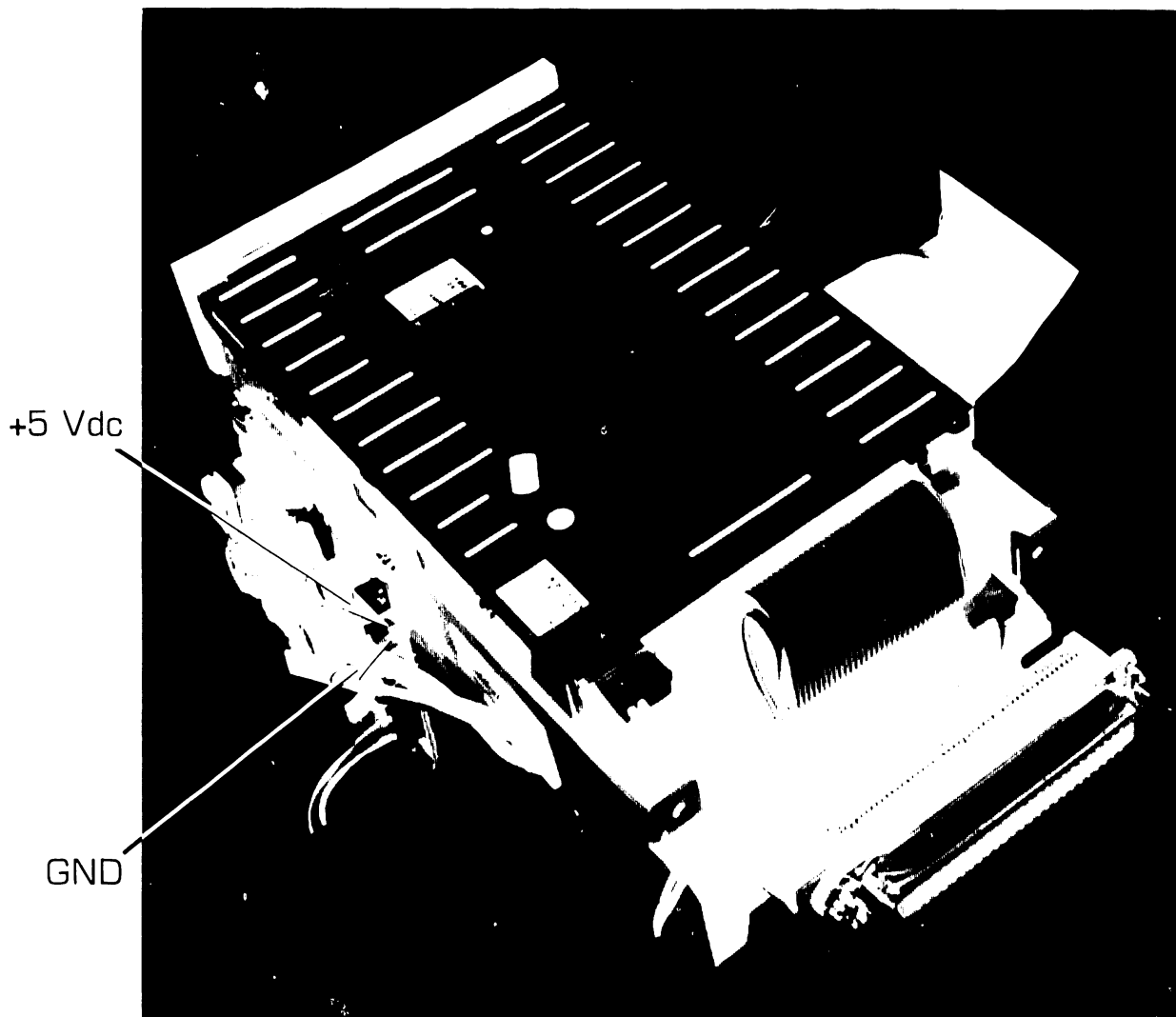

3.4

CONTROLS & INDICATORS

Service Indicators

3.4.3

Voltage Test Points, 5.25-inch FDD

Voltage test points are provided on FDD CNTRL PCB, for the 5.25-inch FDD. Measure POWER PCB voltages on connector J2. Voltages are not adjustable.

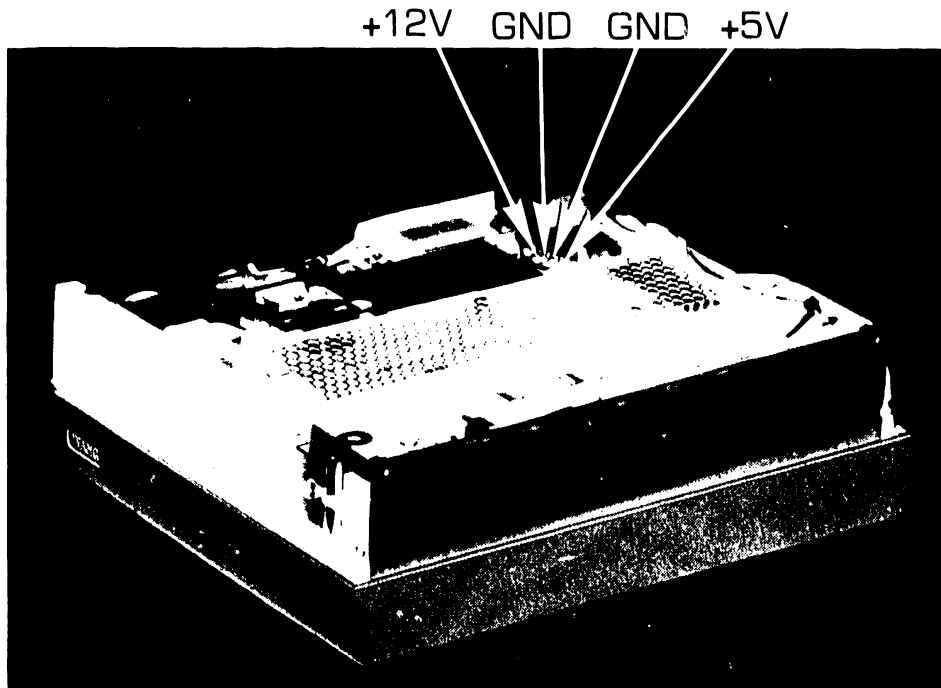

3.5

Operator Controls, 5.25-Inch FDD

REPAIR

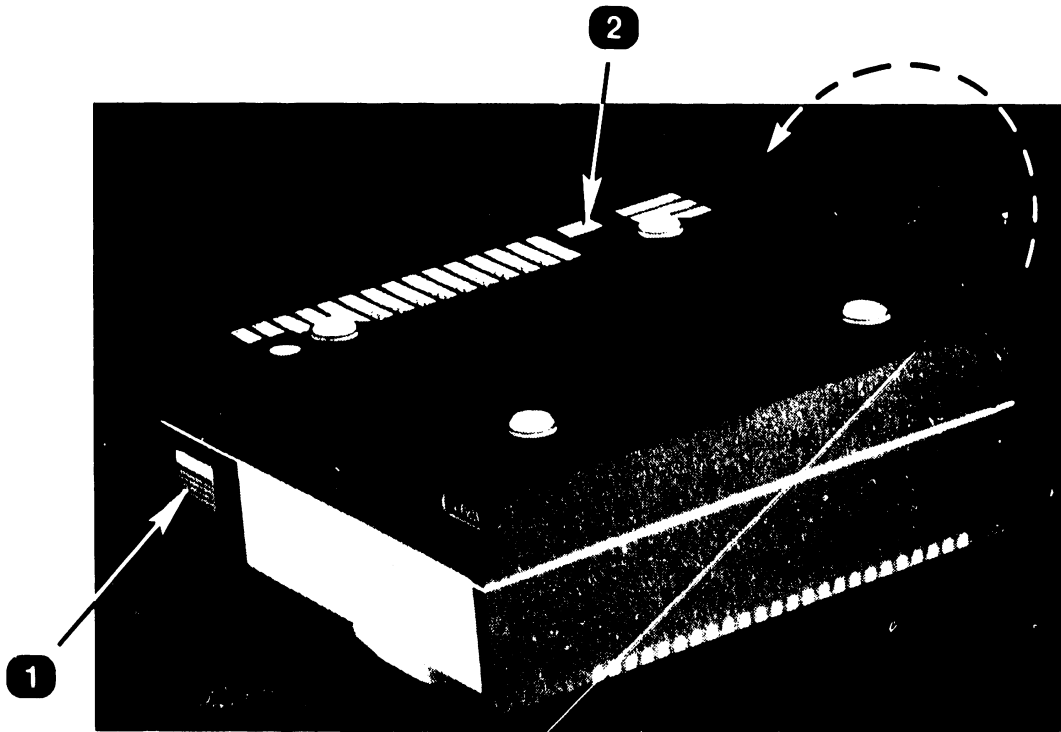

<i>Item</i>	<i>Name</i>	<i>Type and Function</i>
1	On/Off	Toggle Switch with sliding actuator; turns FDD on and off.
2	Voltage Select	Slide Switch; matches FDD power supply to line voltage (115 or 230 Vac).

SECTION

4

OPERATION

SECTION 4 CONTENTS

SECTION 4 OPERATION

		Page
4.1	START-UP	4-1
4.2	PRINTER OPERATION	4-2
4.2.1	Matrix Operation	4-2
4.2.2	Thermal Operation	4-3
4.3	WARM RESTART	4-4

4.1

Start-up

OPERATION

- 1 Slide RELEASE HOOKS forward to unlatch LCD.

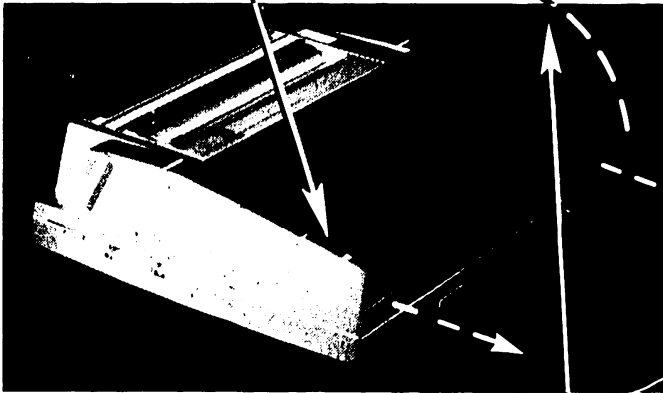

- 2 Swing LCD up into position.

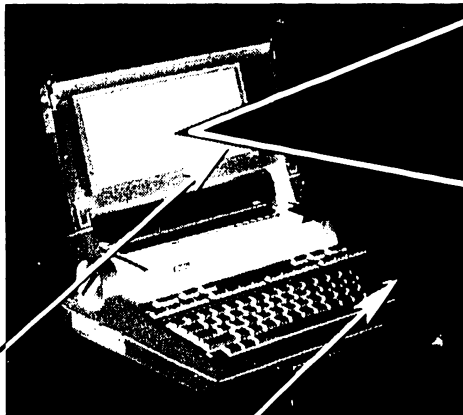

- 3 Press RESET.
- 4 Adjust contrast.

- 5 When "Date and Time" menu appears on display, type date: press Enter. Type time and press EXEC.

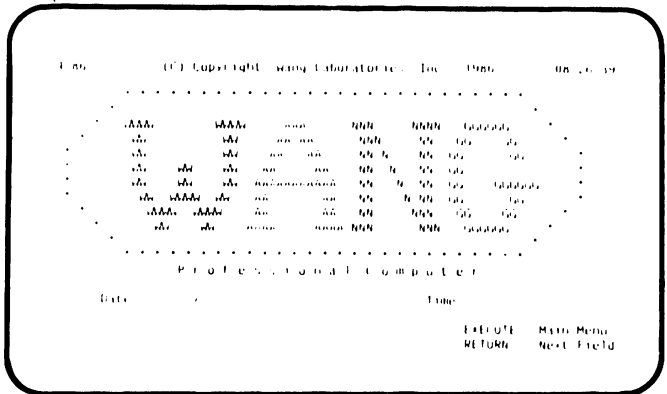

- 6 Select item from "MAIN SYSTEM MENU": Press EXEC. ➡ Wang Professional Computer User's Guide and DOS Command Processor Guide.

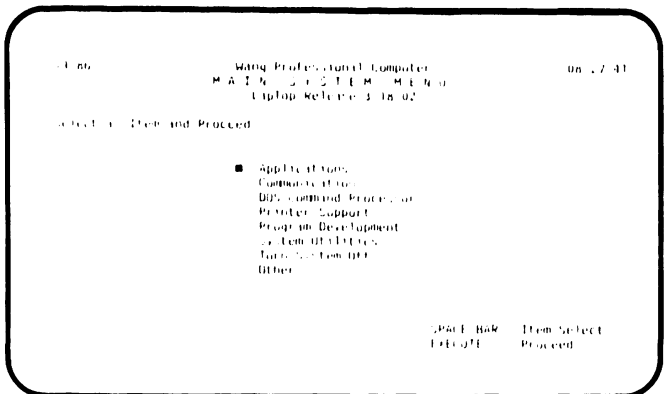

NOTE

First adjust contrast if no graphics show on display.

4.2

Printer Operation

OPERATION

4.2.1

Matrix Operation

The printer can operate either as a matrix printer using standard paper, or as a thermal printer using thermal paper.

- 1 Ensure Printer Density switch is "on" (➤ 3.1).

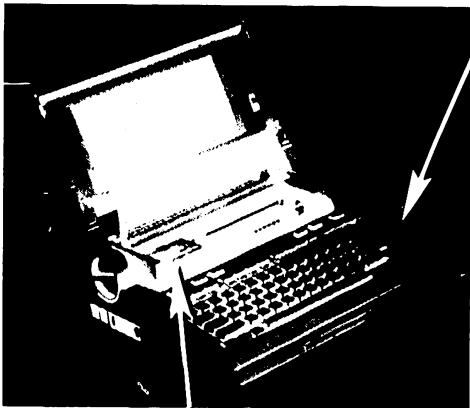

- 2 Ensure ribbon cassette is installed.
- 3 Start up WLTC (➤ 4.1).
- 4 Insert a sheet of paper into printer: hold down PAPER IN key to advance paper.



PAPER
IN
KEY

- 5 To test printer, use Manufacturing Diagnostic Printer Test (➤ 6.2.3).

4.2

Printer Operation

OPERATION

4.2.2

Thermal Operation

The printer can operate either as a matrix printer using standard paper, or as a thermal printer using thermal paper.

- 1 Ensure Printer Density switch is "on" (➤ 3.1).

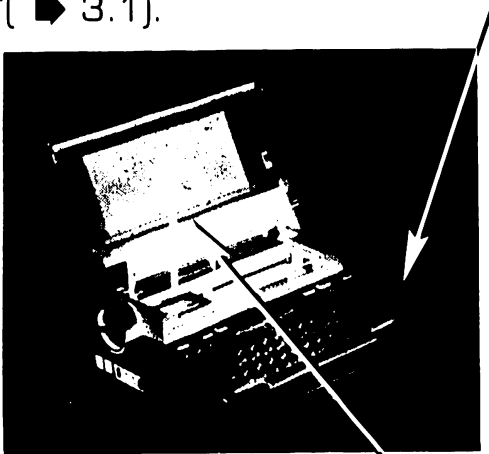

- 2 Ensure ribbon cassette is removed.

- 3 Start up WLTC (➤ 4.1).

- 4 Load roll of thermal paper on PAPER ROLL HOLDER.

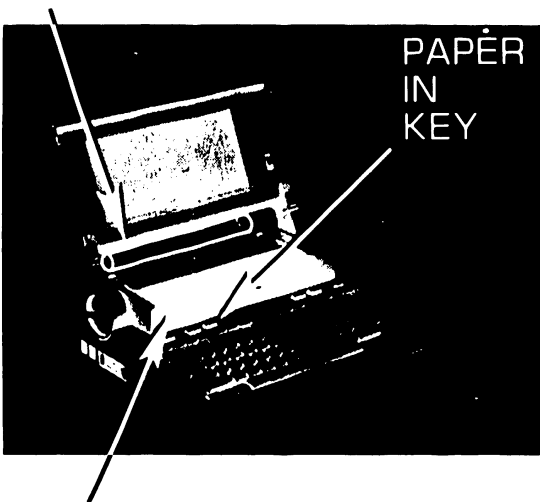

- 5 Load thermal paper into printer: hold down PAPER IN key to advance paper.

- 6 To test printer, use Manufacturing Diagnostic Printer Test (➤ 6.2.3).

4.3

Warm Restart

OPERATION

When the WLTC is on, it can be re-booted without first shutting it off, a warm restart. There are two ways to do this.

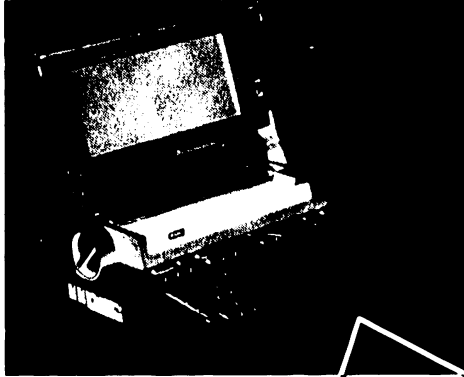

- 1 Press 2ND and F13 (COMMAND) together; then press CANCEL.

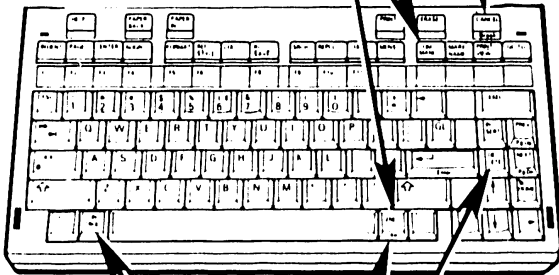

- 2 Press CONTROL, Alt, and DELETE together.

SECTION

5

**PREVENTIVE
MAINTENANCE**

SECTION 5 CONTENTS

SECTION 5 PREVENTIVE MAINTENANCE

Do not attempt preventive maintenance on the Wang LapTop Computer:
No preventive maintenance is required.

SECTION

6

TROUBLESHOOTING

SECTION 6 CONTENTS

SECTION 6 TROUBLESHOOTING

	Page
6.1 TOOLS AND TEST EQUIPMENT	6-1
6.2 BUILT IN TEST	6-2
6.2.1 Brief Description	6-2
6.2.2 Setting BIT Mode	6-4
6.2.3 Manufacturing Diagnostic Menu	6-6
6.2.4 BIT Error Messages	6-8
6.3 CUSTOMER DIAGNOSTIC UTILITY	6-9A
6.4 SERVICE DIAGNOSTIC UTILITY.....	6-9C
6.5 TROUBLESHOOTING CHART	6-10

1 Anti-Static Kit 727-0362

Always wear a properly grounded wrist strap whenever any part of Wang LapTop Computer case is open. Discharge any static charge by wearing wrist strap and connecting it to suitable ground *before* handling the WLTC. The wrist strap must be connected to suitable ground, which, in turn, is ultimately connected to building ground. Such suitable ground might be the main chassis of other electronic office equipment, preferably Wang equipment.

2 Loopback connector 721-0025

6.2

TROUBLESHOOTING

Built In Test

6.2.1 Brief Description (sheet 1 of 2)

1 Hardware Failures
WLTC BIT tests the hardware necessary to boot the WLTC. Hardware failures are either fatal- *will* not boot, or nonfatal- *may* not boot.

2 Tests
Thirteen tests comprise WLTC BIT:

a. Tests 1-4 check boot-PROMS, stack, and video memory. These are fatal errors. Keyboard LEDs display error codes.

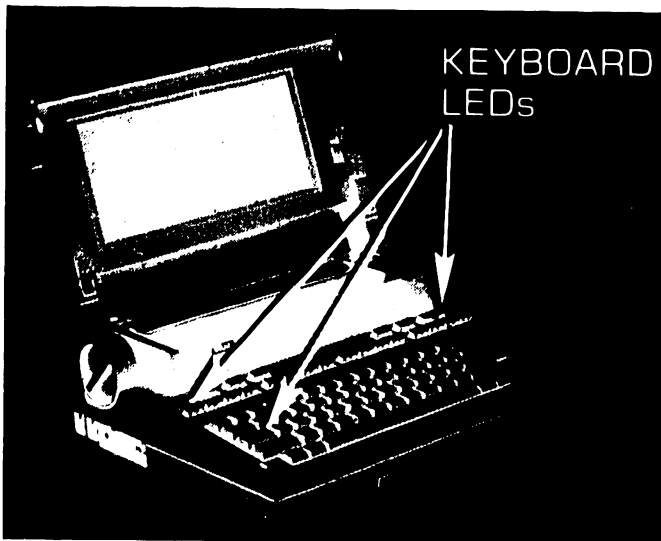

b. Tests 5-10 check main memory, timers, DMA, etc. These are fatal errors. Both the LCD and keyboard LEDs display error messages and codes.

c. Tests 11-13 check system devices such as SCSI Winchester Command and keyboard. These are nonfatal errors. The LCD displays error messages.

3 Modes

Diagnostic jumpers on MAIN PCB control BIT mode.

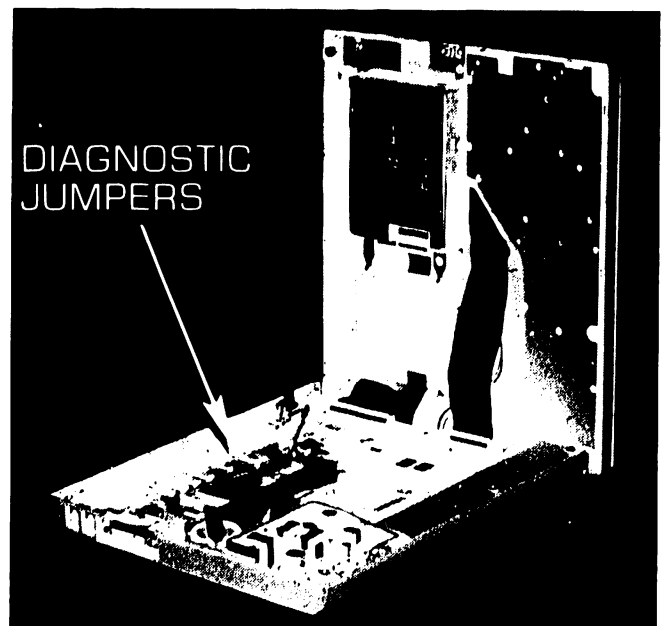

Modes are customer, repair aid, or burn-in:

a. *Customer* is normal operating mode. BIT is run once for all thirteen tests, and MAIN PCB is identified as failed for fatal errors. After successful BIT, WLTC operating system is loaded.

➡NEXT

6.2

TROUBLESHOOTING

Built In Test

6.2.1

Brief Description (sheet 2 of 2)

- b. *Repair-aid* is intended to help board-repair. BIT is run once for all thirteen tests; and failed component, such as Main Memory, is identified for fatal errors. After successful BIT, WLTC operating system is loaded.

- c. *Burn-in* is for testing newly manufactured boards. BIT continuously runs only fatal error tests; and failed component, such as Main Memory, is identified.

◆ END

6.2

Built In Test

6.2.2

Setting BIT Mode (sheet 1 of 2)

CAUTION

Do not change BIT mode for normal, in-office tests on WLTC. Change mode only if additional diagnostic information must be obtained.

Always wear a properly grounded wrist strap whenever any part of WLTC case is open.

1 Open WLTC case, but *do not disconnect any cables.* (➡ 7.3.10).

2 Connect jumper-cap for desired mode (➡ Table 6-1).

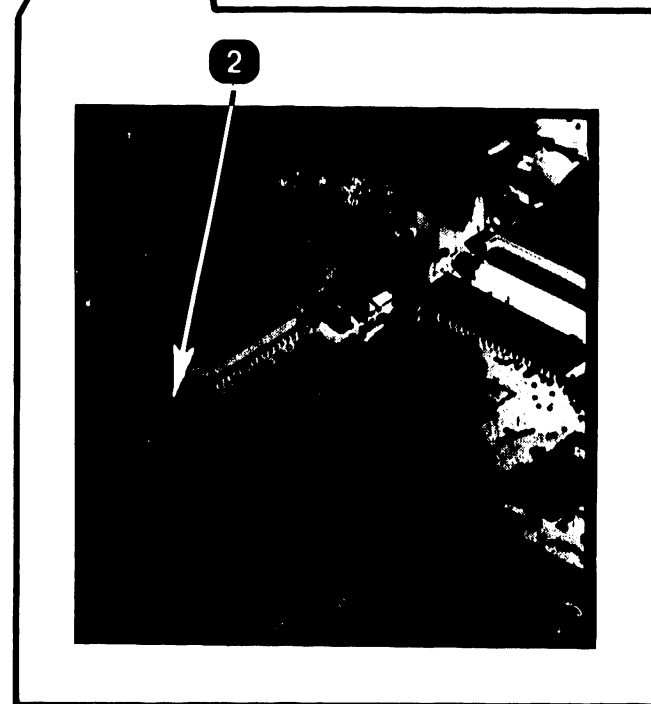
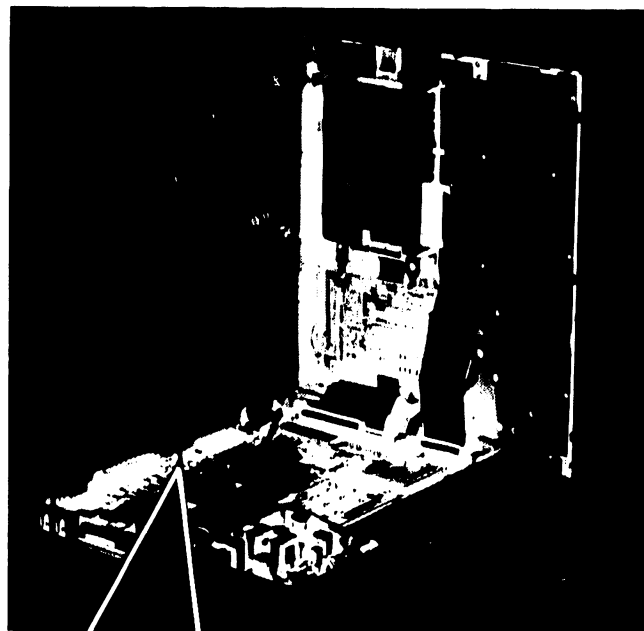

➡NEXT

6.2

TROUBLESHOOTING

Built In Test

6.2.2

Setting BIT Mode (sheet 2 of 2)

Table 6-1

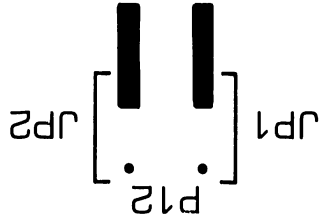
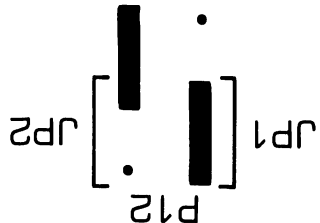
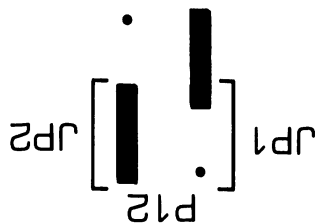
<u>Mode</u>	<u>Jumper Connection</u>	<u>Mode Description</u>
Customer		Normal operating mode; BIT is run once for all thirteen tests, and MAIN PCB is identified as failed for fatal errors. After successful BIT, WLTC operating system is loaded.
Repair Aid		For board-repair; BIT is run once for all thirteen tests; and failed component, such as Main Memory, is identified for fatal errors. After successful BIT, WLTC operating system is loaded.
Burn In		For testing newly manufactured boards; BIT continuously runs only fatal error tests; and failed component, such as Main Memory, is identified.

● END

6.2

TROUBLESHOOTING

Built In Test

6.2.3

Manufacturing Diagnostic Menu (sheet 1 of 2)

CAUTION

The Manufacturing Diagnostic Menu is not normally used in the field: these tests are provided to test, more thoroughly, the MAIN PCB ASSY during burn-in of newly manufactured boards.

A 3-second timeout occurs after BIT is completed. The Manufacturing Diagnostic Menu may be accessed during this timeout by pressing the "M" key. Select menu options by entering number displayed next to desired test. Leave menu by either "warm" or "cold" boot.

Tests are described in Table 6-2.

- 1 Press "M" key during 3-second timeout.

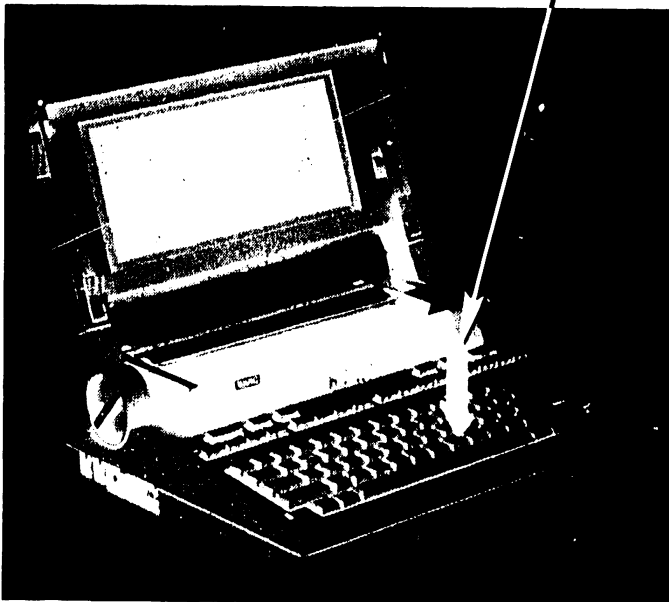

- 2 Enter number displayed next to desired test.

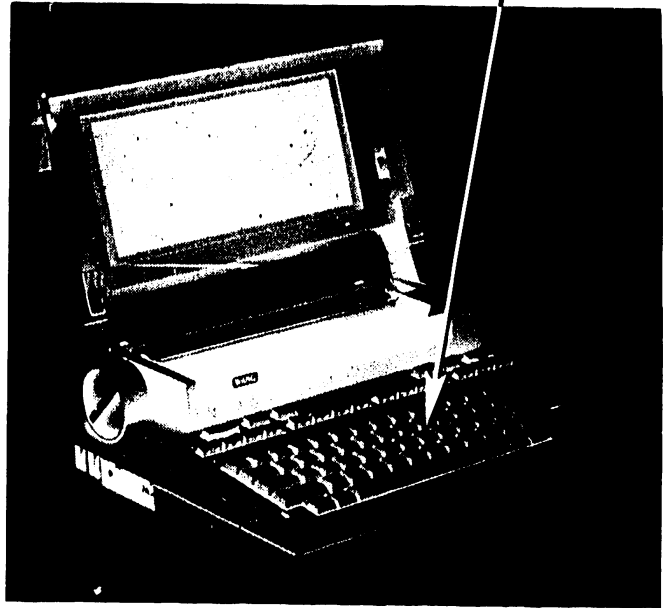

- 3 "Warm" or "cold" boot WLTC to leave Manufacturing Diagnostic Menu.

NOTE

FDD must be connected and turned on or error message "Floppy Reset Error" will appear above Manufacturing Diagnostic Menu.

▶ NEXT

6.2

TROUBLESHOOTING

Built In Test

6.2.3

Manufacturing Diagnostic Menu (sheet 2 of 2)

Table 6-2

<i>Test</i>	<i>Description</i>
Recalibrate Floppy	Tests floppy drive A. Issues Recalibrate command and performs timed loop for command completion and positioning heads 0 + 1 over track 0.
Seek Cylinder Test	Tests floppy drive A. Issues Seek command with user selected cylinder and performs timed loop for command completion and positioning heads 0 + 1 over correct cylinder.
Keyboard Test	Tests keyboard LEDs and tone generator. Displays sliding one pattern. on keyboard LEDs three times (1-second "on" for each LED). Activates clicker each time LED lights. Activates tone generator thirteen times in increasing order while flashing NSB LED at 10Hz rate.
External RS-232 Test	Tests RS-232 port. Loop-back connector must be in place. Compares sliding one pattern sent to RS-232 port with pattern received back through connector.
Printer Test	Tests built-in thermal printer. Paper must be loaded into printer. Sends alpha-numeric pattern to printer.

● END

6.2

TROUBLESHOOTING

Built In Test

6.2.4 BIT Error Messages (sheet 1 of 2)

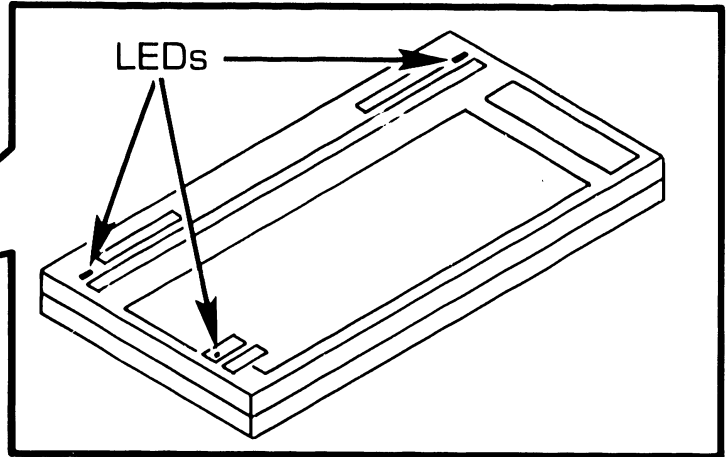
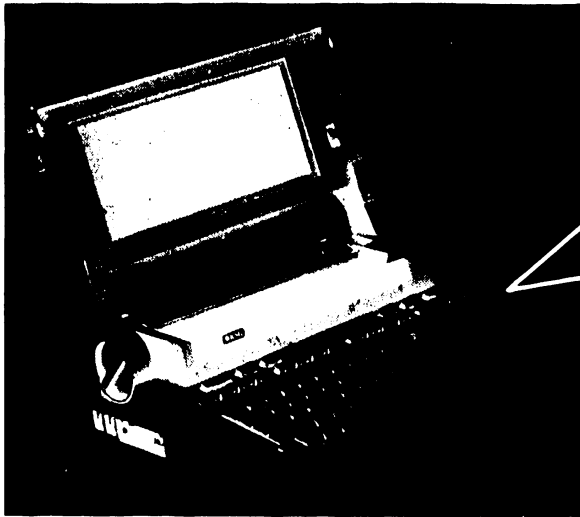

Table 6-3

No.	LED Code	Displayed Messages	
		Customer Mode	Repair-aid Mode
1	<input type="checkbox"/> <input type="checkbox"/>	No display	No display
2	<input checked="" type="checkbox"/> <input type="checkbox"/>	No display	No display
3	<input checked="" type="checkbox"/> <input type="checkbox"/>	No display	No display
4	<input checked="" type="checkbox"/> <input checked="" type="checkbox"/>	No display	No display
5	<input type="checkbox"/> <input checked="" type="checkbox"/>	05 During Power-On Diagnostics 57 System Card Failure	05 During Power-On Diagnostics 55 Status Error-Timer 0 Test
6	<input type="checkbox"/> <input checked="" type="checkbox"/>	05 During Power-On Diagnostics 57 System Card Failure	05 During Power-On Diagnostics 55 Status Error-SCSI Reset Test
7	<input checked="" type="checkbox"/> <input checked="" type="checkbox"/>	05 During Power-On Diagnostics 57 System Card Failure	05 During Power-On Diagnostics 51 Memory Error-Main Memory or 51 Memory Error-Option Memory
8	<input checked="" type="checkbox"/> <input checked="" type="checkbox"/>	05 During Power-On Diagnostics 57 System Card Failure	05 During Power-On Diagnostics 55 Status Error-Timer 1 Test or 51 Memory Error-Timer 2 Test

Lighted Unlighted Flashing

➡NEXT

6.2

TROUBLESHOOTING

Built In Test

6.2.4

BIT Error Messages (sheet 2 of 2)

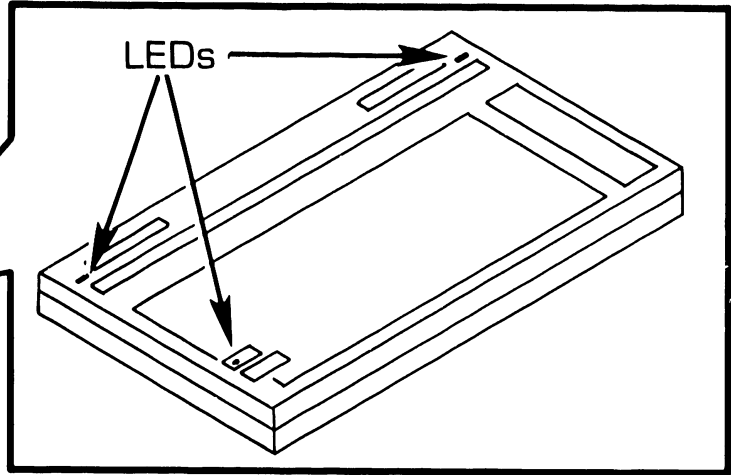
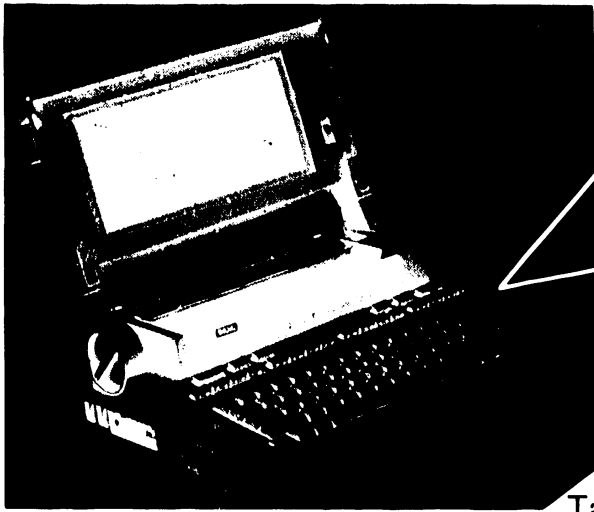

Table 6-3

No.	LED Code	Displayed Messages	
		Customer Mode	Repair-aid Mode
9	<div style="display: flex; align-items: center; gap: 5px;"> ⊗ □ </div>	05 During Power-On Diagnostics 55 Status Error-Battery Low Active	05 During Power-On Diagnostics 55 Status Error-Battery Low Active or 55 Status Error- RTC Test
10	<div style="display: flex; align-items: center; gap: 5px;"> ⊗ □ </div>	05 During Power-On Diagnostics 57 System Card Failure	05 During Power-On Diagnostics 55 Status Error-SCSI Register Test
11	<div style="display: flex; align-items: center; gap: 5px;"> □ □ </div>	* 32 Winchester Showed 55 Status Error-SCSI Winchester Command Test	
12	<div style="display: flex; align-items: center; gap: 5px;"> □ □ </div>	* 32 System Keyboard Port Showed 55 Status Error-Keyboard Test	
13	<div style="display: flex; align-items: center; gap: 5px;"> □ □ </div>	* 32 Serial Port Showed 55 Status Error-Serial Communication Channel A Test or 55 Status Error-Serial Communication Channel B Test	

⊗ Lighted
□ Unlighted
⊗ Flashing

● END

6.3

TROUBLESHOOTING

Customer Diagnostic Utility (sheet 1 of 2)

The Customer Diagnostic Utility resides on diskette and is supported by its own documentation. The diagnostic runs with minimum intervention by operator and isolates to CRU level. There are two operating modes:

default --automatically executes all tests

step --executes CPU test, then prompts operator to continue subsequent tests.

NOTE

Ensure FDD is connected and turned on. Do not insert diskette into FDD until system software is loaded from Winchester HDD.

3 Verify "Command Processor" menu.

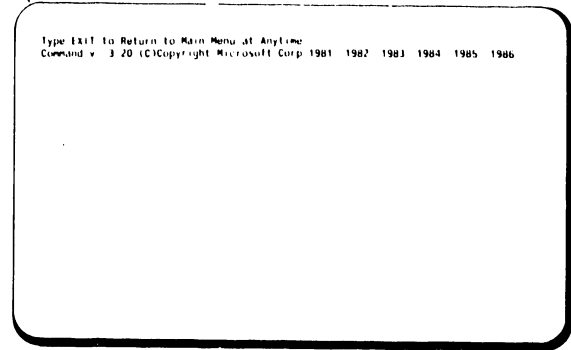

4 Insert diskette into FDD.

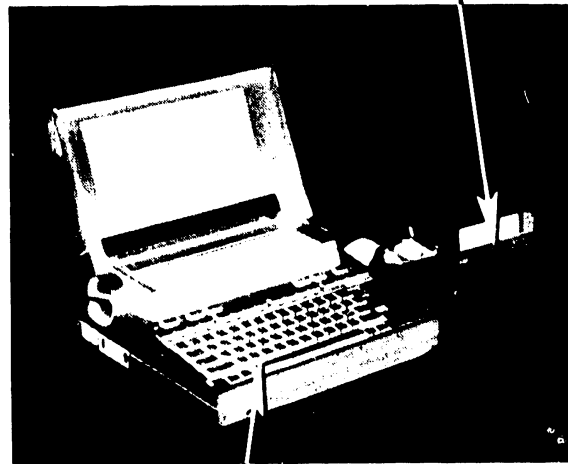

5 Type "A: [Enter]"

1 Press RESET and proceed to "MAIN SYSTEM MENU".

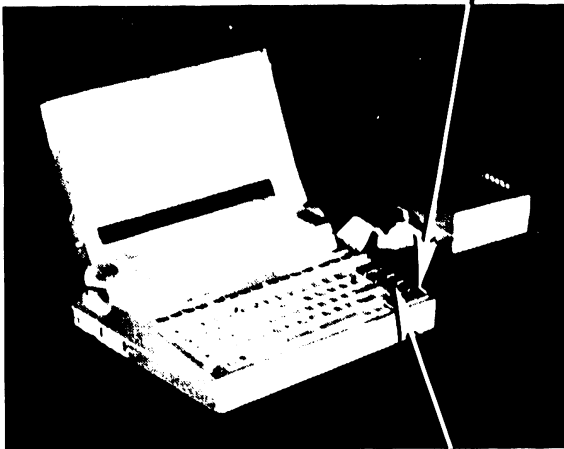

2 Select "DOS Command Processor" and press EXECUTE.

➡ NEXT

6.3

TROUBLESHOOTING

Customer Diagnostic Utility (sheet 2 of 2)

6 Verify that system returns A >

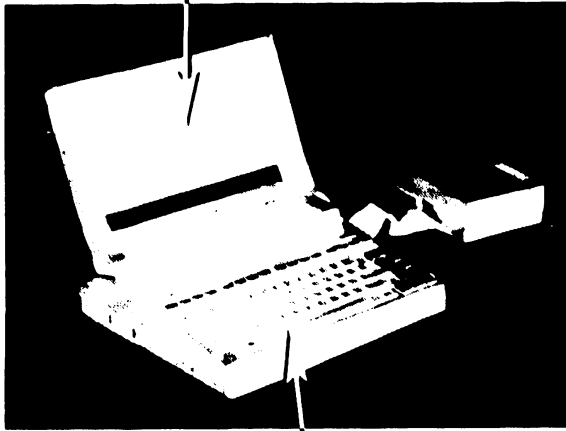

7 Type "WLTCDIAG (Enter)"

8 Verify "Diagnostic Utility" menu.

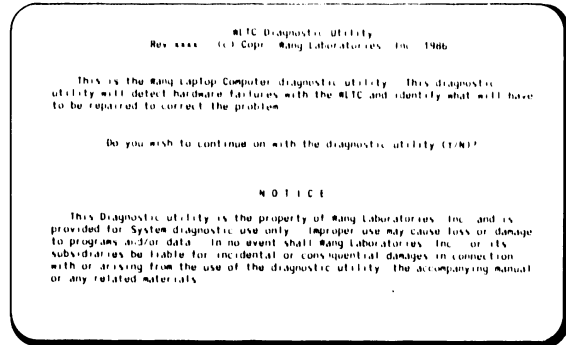

9 Follow menu instructions and refer to customer utility documentation.

NOTE

For step mode, type
"WLTCDIAG /S (Enter)"

● END

6.4

TROUBLESHOOTING

Service Diagnostic Utility (sheet 1 of 2)

The Service Diagnostic Utility resides on diskette and is supported by its own documentation. The diagnostic isolates to FRU level and provides detailed error reporting.

NOTE

Ensure FDD is connected and turned on. Do not insert diskette into FDD until system software is loaded from Winchester HDD.

- 1 Press RESET and proceed to "MAIN SYSTEM MENU".

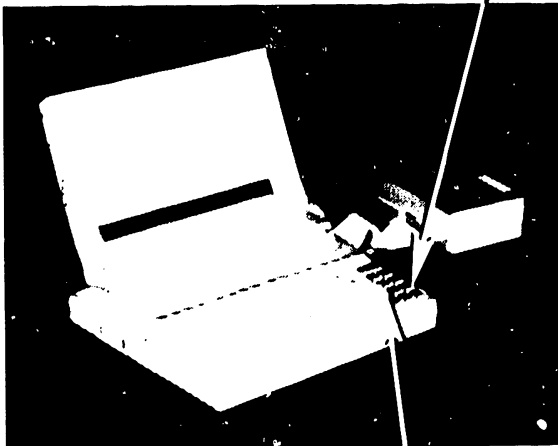

- 2 Select "DOS Command Processor" and press EXECUTE.

- 3 Verify "Command Processor" menu.

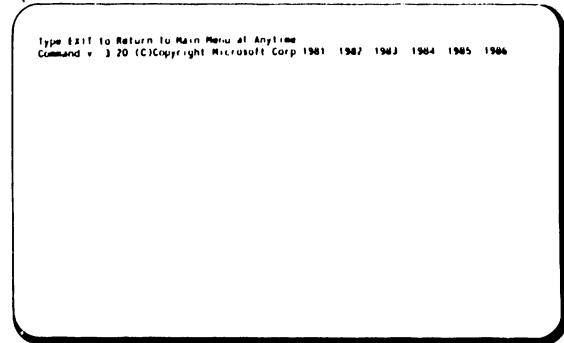

- 4 Insert diskette into FDD.

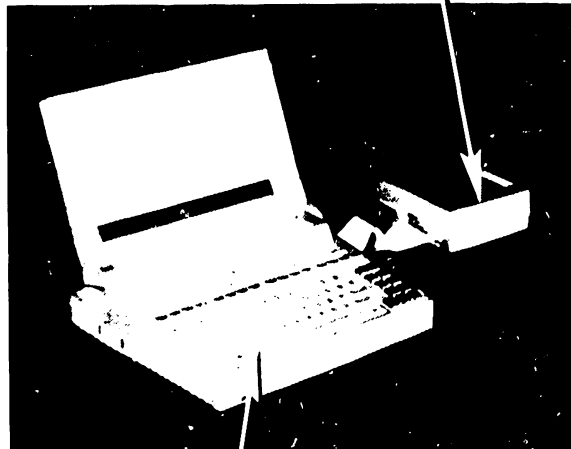

- 5 Type "A: [Enter]"

➡ NEXT

6.4

TROUBLESHOOTING

Service Diagnostic Utility (sheet 2 of 2)

6 Verify that system returns A >

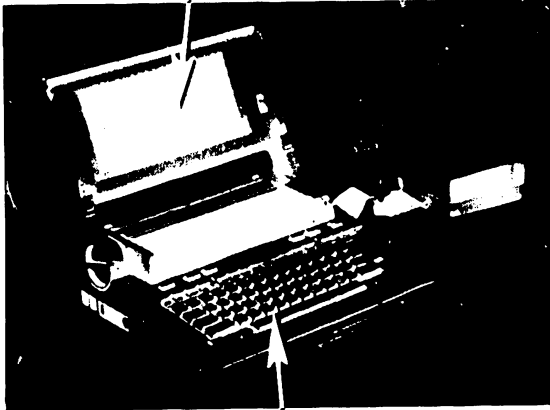

7 Type "WLTCSEV (Enter)"

9 Follow menu instructions and refer to service utility documentation.

NOTE

Some function keys have special uses during diagnostics:

- F4- press to continuously loop on current test
press again to stop looping
- F6- press to continue testing after error detection and display
press SHIFT-CANCEL to return to "Diagnostic Service Utility" menu.

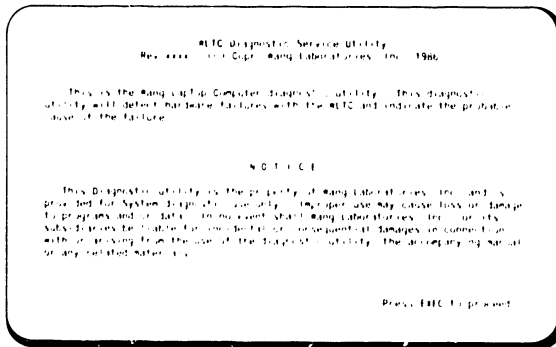

8 Verify "Diagnostic Service Utility" menu.

●END

TROUBLESHOOTING

6.5 Troubleshooting Chart (sheet 1 of 2)

<i>Trouble</i>	<i>Test</i>	<i>Action</i>
No display when turned on	Check contrast adjustment Check battery connection Check AC ADAPTER connection	Adjust contrast Connect NICAD BATTERY Replace NICAD BATTERY Connect AC ADAPTER
Will not run B.I.T.	Check AC ADAPTER output Check POWER PCB volt-ages	Replace AC ADAPTER Replace POWER PCB ASSY
Fails B.I.T.--fatal error	Check for memory failure	Replace STD or OPT RAM PCB ASSY
	Check for MAIN PCB failure	Replace MAIN PCB ASSY
Fails B.I.T.--nonfatal error	Load diagnostic diskette Run SCSI/HDD diagnostics	Replace HDD
	Run K/B diagnostics	Replace HDD PCB ASSY Replace K/B FULL ASSY Replace MAIN PCB ASSY
Won't load diagnostic diskette	Check diskette media Check FDD Check FDD POWER PCB Check FDD SCSI CABLE Check FDD SCSI PCB ASSY Load diagnostics diskette in drive B	Replace diskette Replace FDD Replace FDD POWER PCB Replace FDD SCSI CABLE Replace FDD SCSI PCB ASSY
Won't load diagnostic diskette in drive B		Replace MAIN PCB

▶ NEXT

TROUBLESHOOTING

6.5 Troubleshooting Chart (sheet 2 of 2)

<i>Trouble</i>	<i>Test</i>	<i>Action</i>
No "Date & Time" menu	Swap component Check negative 20 Vdc--fail Check negative 20 Vdc--pass Swap component	Replace LCD ASSY Replace POWER PCB ASSY Replace MAIN PCB ASSY Replace ARM FPC CABLE
Scrambled "Date & Time" menu	Swap component Check ARM FPC CABLE	Replace MAIN PCB ASSY Replace K/B FULL ASSY
No "Main" menu	Swap component Check negative 20 Vdc--fail Check negative 20 Vdc--pass Check ARM FPC CABLE	Replace LCD ASSY Replace POWER PCB ASSY Replace MAIN PCB ASSY Replace K/B FULL ASSY
Scrambled "Main" menu	Swap component Check ARM FPC CABLE	Replace MAIN PCB ASSY Replace K/B FULL ASSY
Will not print	Check Printer Density Switch Run printer diagnostics--fail Run printer diagnostics--pass Swap component Swap component	Set to "dark" Replace MAIN PCB ASSY Replace PRINTER PCB ASSY Replace PRINTER ASSY Replace MAIN PCB ASSY
Prints, but fails diagnostic	Swap component Swap component Swap component	Replace MAIN PCB ASSY Replace PRINTER PCB ASSY Replace PRINTER ASSY

●END

SECTION

7

REPAIR

SECTION 7 CONTENTS

SECTION 7 REPAIR

	Page
7.1 TOOLS AND TEST EQUIPMENT	7-1
7.2 INTERNAL CONNECTORS	7-2
7.2.1 Disconnecting FPC Connectors	7-2
7.2.2 Reconnecting FPC Connectors	7-3
7.2.3 Disconnecting Mini-Connectors	7-5
7.2.4 Reconnecting Mini-Connectors	7-6
7.2.5 Matching Print Head to Printer PCB	7-7A
7.3 REMOVAL PROCEDURES	7-8
7.3.1 Rear Cover	7-8
7.3.2 OPT RAM PCB Assembly	7-9
7.3.3 Modem PCB Assembly	7-10
7.3.4 LCD Assembly	7-11
7.3.5 Battery Cover	7-12
7.3.6 NICAD BATT Assembly	7-13
7.3.7 Arm Cap R	7-14
7.3.8 Platen Knob Assembly	7-15
7.3.9 Cassette Cover Assembly	7-16
7.3.10 Separating Upper Case From Lower	7-17
7.3.10A Earth SP	7-19A
7.3.11 Reset Button	7-20
7.3.12 STD RAM PCB	7-21
7.3.13 Sub Batt Assembly	7-22
7.3.14 Power PCB Assembly	7-23
7.3.15 Main PCB	7-24
7.3.16 Lower Case	7-26
7.3.17 HDD PCB (SCSI)	7-27
7.3.18 HDD Cable 26	7-29
7.3.19 HDD Cable 50	7-30
7.3.20 HDD Power Cable 4-Pin	7-31
7.3.21 Printer PCB Assembly	7-31A
7.3.22 HDD Assembly	7-32
7.3.23 Printer Assembly	7-33
7.3.24 K/B Full Assembly	7-34

► NEXT

SECTION 7 CONTENTS

SECTION 7 REPAIR

	Page
7.4 REINSTALLATION PROCEDURES	7-35
7.4.1 Rear Cover	7-35
7.4.2 OPT RAM PCB Assembly	7-36
7.4.3 Modem PCB Assembly	7-37
7.4.4 LCD Assembly	7-38
7.4.5 Battery Cover	7-39
7.4.6 NICAD BATT Assembly	7-40
7.4.7 Arm Cap R	7-42
7.4.8 PLaten Knob Assembly	7-43
7.4.9 Cassette Cover Assembly	7-44
7.4.10 Reconnect Upper and Lower Case	7-45
7.4.11 Earth SP	7-47
7.4.12 Reset Button	7-49
7.4.13 STD RAM PCB	7-50
7.4.14 Sub Batt Assembly	7-51
7.4.15 Power PCB Assembly	7-53
7.4.16 Main PCB	7-54
7.4.17 Lower Case	7-56
7.4.18 HDD PCB (SCSI)	7-57
7.4.19 HDD Cable 26	7-59
7.4.20 HDD Cable 50	7-60
7.4.21 HDD Power Cable 4-Pin	7-61
7.4.22 Printer PCB Assembly	7-62
7.4.23 HDD Assembly	7-65
7.4.24 Printer Assembly	7-66
7.4.25 K/B Full Assembly	7-69
7.5 REMOVAL PROCEDURES, 3.5-INCH FDD.....	7-70
7.5.1 Access	7-70
7.5.2 Battery Lid	7-72
7.5.3 NICAD Battery	7-73
7.5.4 Power SW Assembly	7-74
7.5.5 Power Jack Assembly	7-75
7.5.6 Power PCB Assembly	7-76
7.5.7 FDD IF Cable	7-78

◆ NEXT

SECTION 7 CONTENTS

SECTION 7 REPAIR

	Page
7.5.8 FDD	7-79
7.5.9 SCSI PCB Assembly	7-81
7.5.10 SCSI Cable Assembly	7-82
7.6 REINSTALLATION PROCEDURES, 3.5-INCH FDD	7-83
7.6.1 Reassembly	7-83
7.6.2 Battery Lid	7-85
7.6.3 NICAD Battery	7-86
7.6.4 Power SW Assembly	7-87
7.6.5 Power Jack Assembly	7-88
7.6.6 Power PCB Assembly	7-89
7.6.7 FDD IF Cable	7-91
7.6.8 FDD	7-92
7.6.9 SCSI PCB Assembly	7-94
7.6.10 SCSI Cable Assembly	7-96
7.7 REMOVAL PROCEDURES, 5.25-INCH FDD	7-97
7.7.1 Access	7-97
7.7.2 Power PCB Assembly	7-99
7.7.3 FDD	7-101
7.7.4 SCSI PCB Assembly	7-102
7.7.5 SCSI BUS Cable	7-103
7.8 REINSTALLATION PROCEDURES, 5.25-INCH	7-104
7.8.1 Reassembly	7-104
7.8.2 Power PCB Assembly	7-106
7.8.3 FDD	7-109
7.8.4 SCSI PCB Assembly	7-110
7.8.5 SCSI BUS Cable	7-111

◆END

1 Anti-Static Kit 727-0362

Always wear a properly grounded wrist strap whenever any part of Wang LapTop Computer case is open. Discharge any static charge by wearing wrist strap and connecting it to suitable ground *before* handling the WLTC. The wrist strap must be connected to suitable ground, which, in turn, is ultimately connected to building ground. Such suitable ground might be the main chassis of other electronic office equipment, preferably Wang equipment.

2 No other special tools or test equipment are required to repair the WLTC.

7.2

Internal Connectors

REPAIR

7.2.1

Disconnecting FPC Connectors

CAUTION

Always wear a properly grounded wrist strap whenever any part of WLTC case is open.

Connectors for FPC cabling must be unlocked before the FPC cable is removed. FPC cables must be correctly oriented or no electrical connection whatsoever will be made: contacts are on one side of cable only.

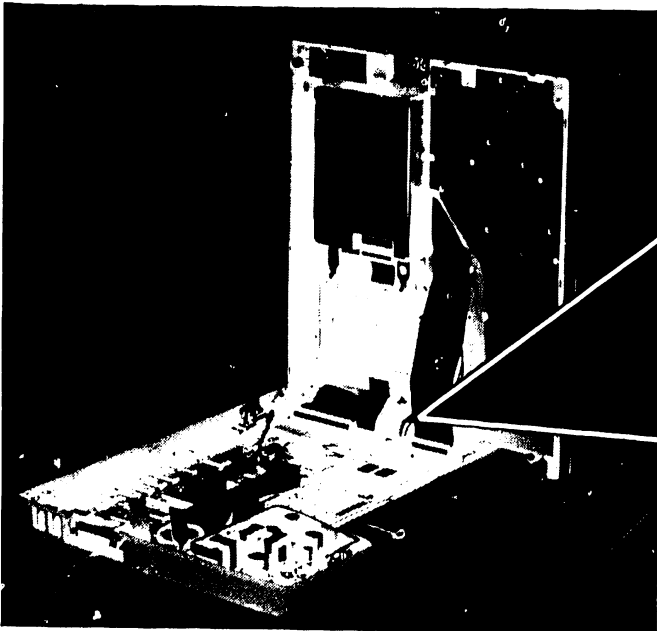

- 1 With a small screwdriver, carefully pry up locking bar, evenly, at both ends.

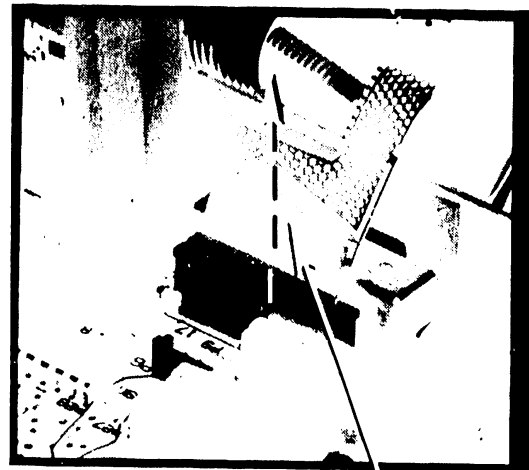
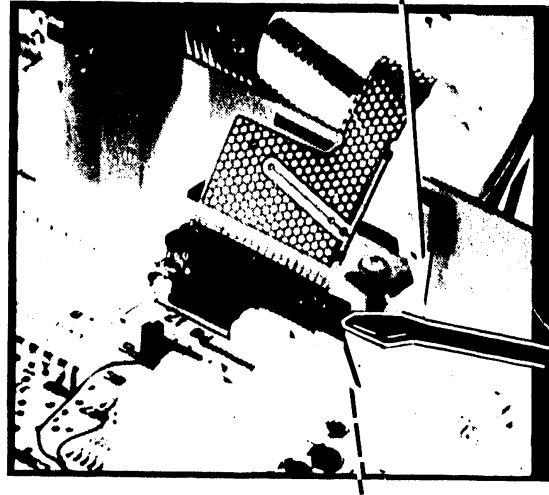

- 2 Note orientation of FPC cable and gently lift cable free of connector.

7.2

Internal Connectors

REPAIR

7.2.2

Reconnecting FPC Connectors (sheet 1 of 2)

CAUTION

Always wear a properly grounded wrist strap whenever any part of WLTC case is open.

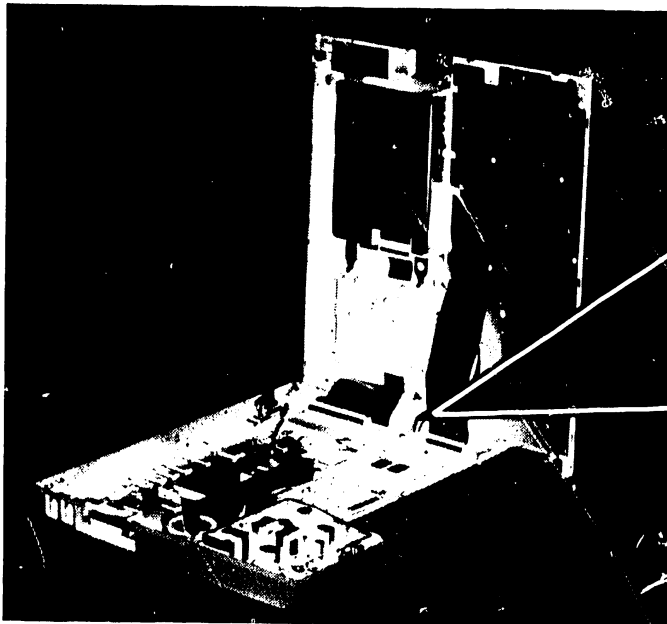

- 1 Ensure locking bar is evenly raised.

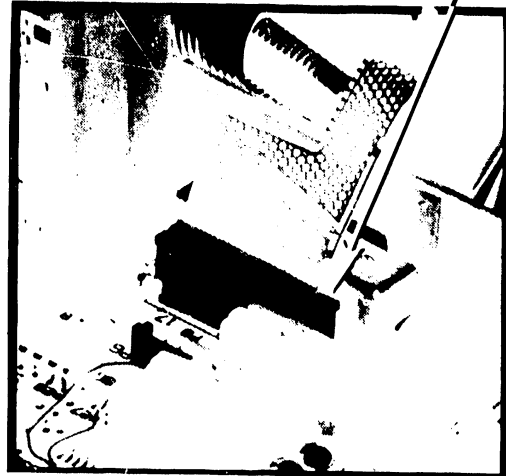

- 2 Insert FPC cable into connector, ensuring proper orientation. If necessary, hold locking bar in raised position with small screwdriver while inserting cable.

►NEXT

7.2

Internal Connectors

REPAIR

7.2.2

Reconnecting FPC Connectors (sheet 2 of 2)

CAUTION

Always wear a properly grounded wrist strap whenever any part of WLTC case is open.

- 3 Lock connector by pressing down evenly on locking bar.

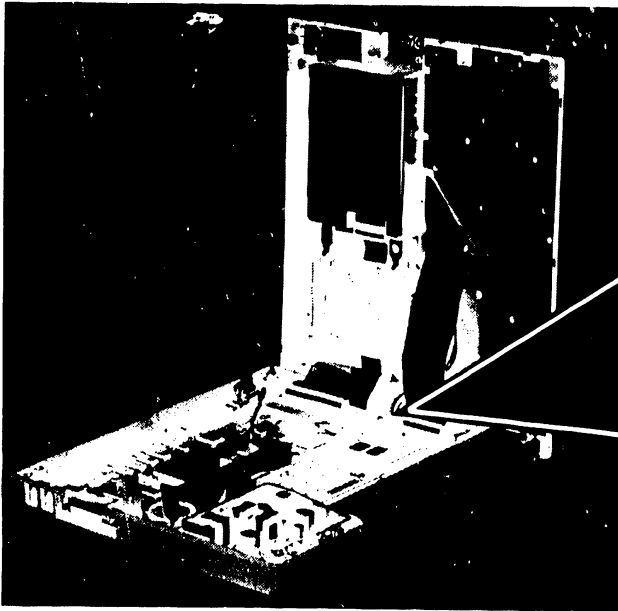
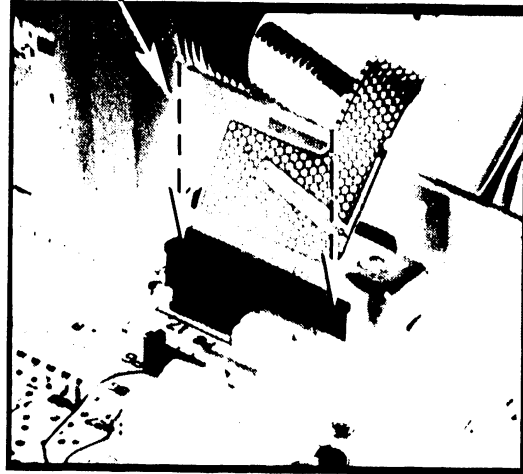

● END

7.2

Internal Connectors

REPAIR

7.2.3

Disconnecting Mini-Connectors

CAUTION

Always wear a properly grounded wrist strap whenever any part of WLTC case is open.

Many connectors in this unit are small and difficult to access. Disconnect as gently as possible, taking care not to damage cables or to pull them loose from connectors.

CAUTION

Pulling on the wires to disconnect these mini-connectors is *not* recommended, although manufacturing engineers say this procedure is permissible. It has been noticed that contacts are easily pulled, or pushed, out of the molded plastic casing.

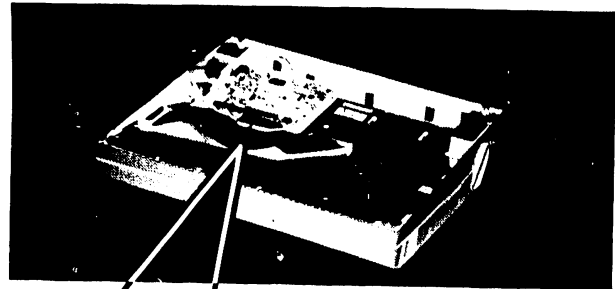

- 1 Using a small screwdriver against "ledge" on connector, carefully separate male and female halves of connector.

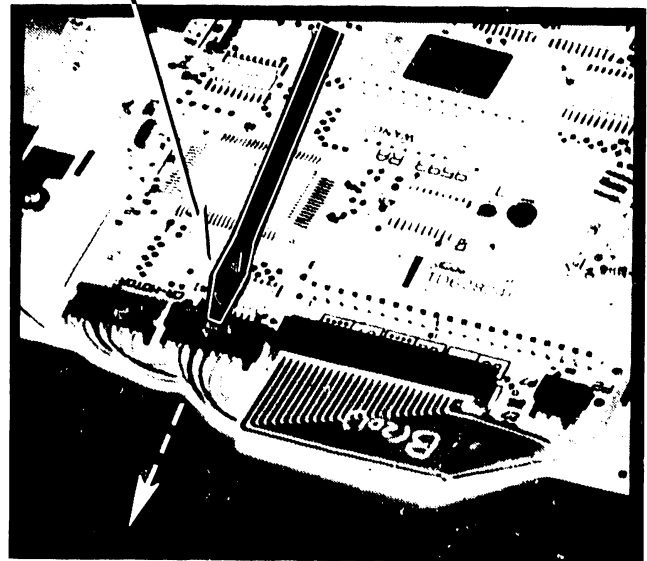

7.2

Internal Connectors

REPAIR

7.2.4

Reconnecting Mini-Connectors (sheet 1 of 2)

CAUTION

Always wear a properly grounded wrist strap whenever any part of WLTC case is open.

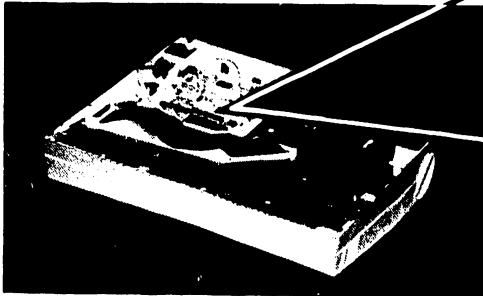

1 Align male and female halves.

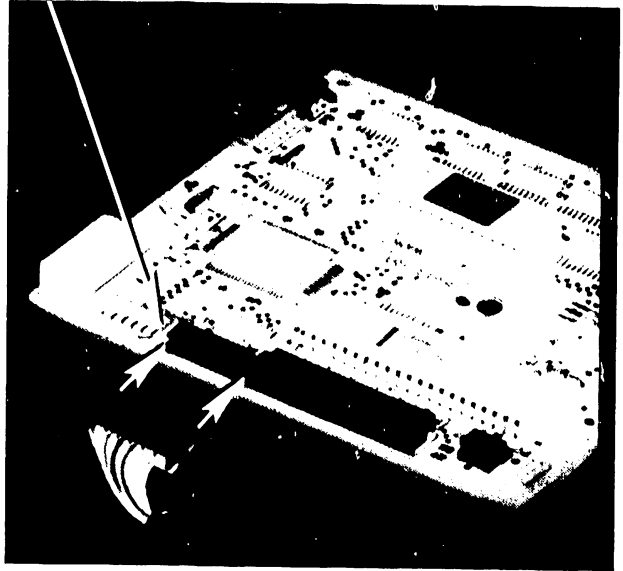

CAUTION

Use care when pressing the two halves together: the connector contacts may push out of the molded plastic casing.

➡NEXT

7.2

Internal Connectors

REPAIR

7.2.4

Reconnecting Mini-Connectors (sheet 2 of 2)

CAUTION

Always wear a properly grounded wrist strap whenever any part of WLTC case is open.

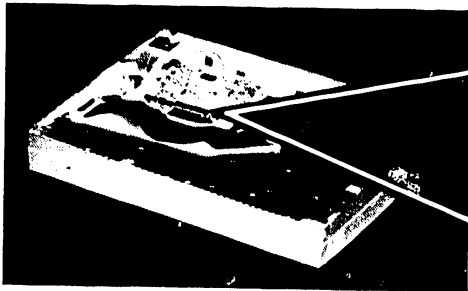

- 2 Push halves together until fully seated. If necessary, push against "ledge" with a small screwdriver.

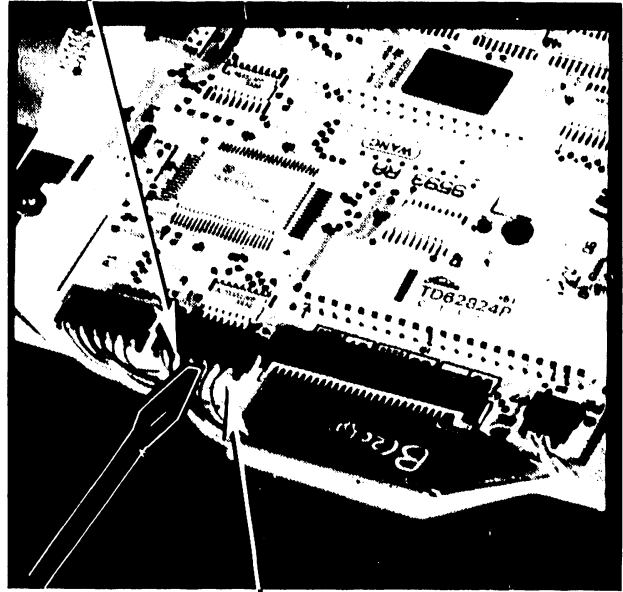

- 3 Examine connector and ensure that all contacts are fully inserted into the molded plastic casing.

● END

7.2

Internal Connectors

REPAIR

7.2.5

Matching PRINT HEAD to PRINTER PCB

CAUTION

Always wear a properly grounded wrist strap whenever any part of WLTC case is open.

Resistance values for PRINT HEAD *must* be matched on PRINTER PCB ASSY or print quality will degrade. PRINT HEAD classification (A, B, D, E or F) is marked on FPC CABLE, and matching solder-point on PRINTER PCB ASSY must be soldered.

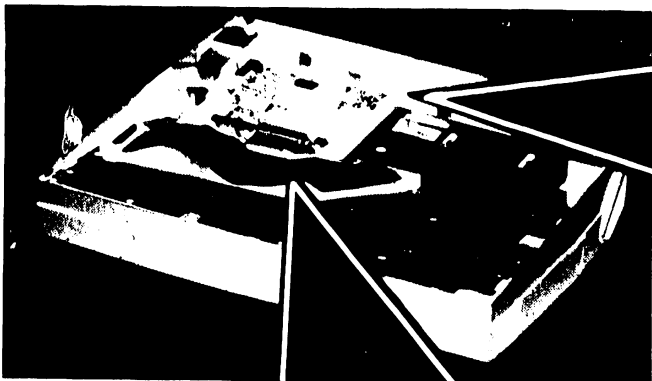

- 2 Inspect solder-point on PRINTER PCB ASSY: Ensure matching solder-point is soldered.

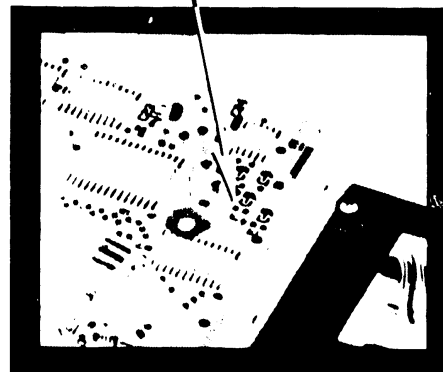

NOTE

If necessary, solder correct solder-point and de-solder incorrect one.

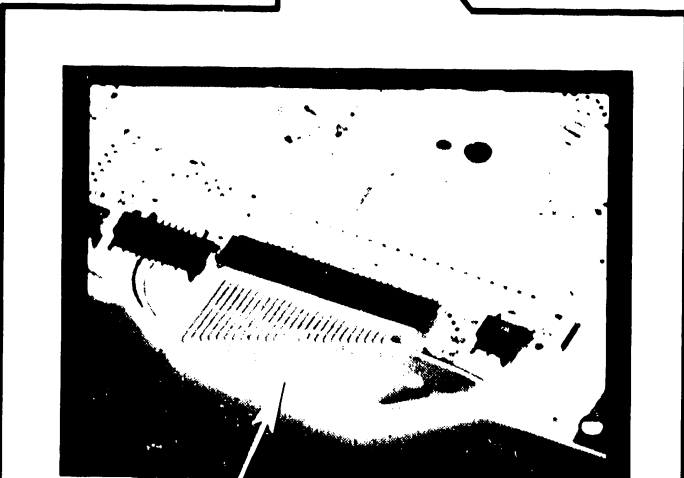

- 1 Check PRINT HEAD classification on FPC CABLE.

7.2

Internal Connectors

REPAIR

7.2.6

Repairing Machine-Inserts (sheet 1 of 2)

CAUTION

Always wear a properly grounded wrist strap whenever any part of the WLTC case is open. Do **not** use glue of any kind to repair machine-inserts.

A loose machine-insert may be repaired by heating the insert until surrounding plastic softens, then waiting until the plastic cools.

- 1 Separate UPPER CASE from LOWER (➡ 7.3.10).

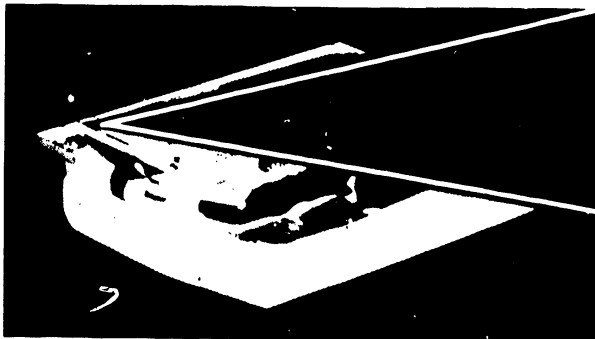

- 2 Heat machine-insert with soldering iron until surrounding plastic melts.

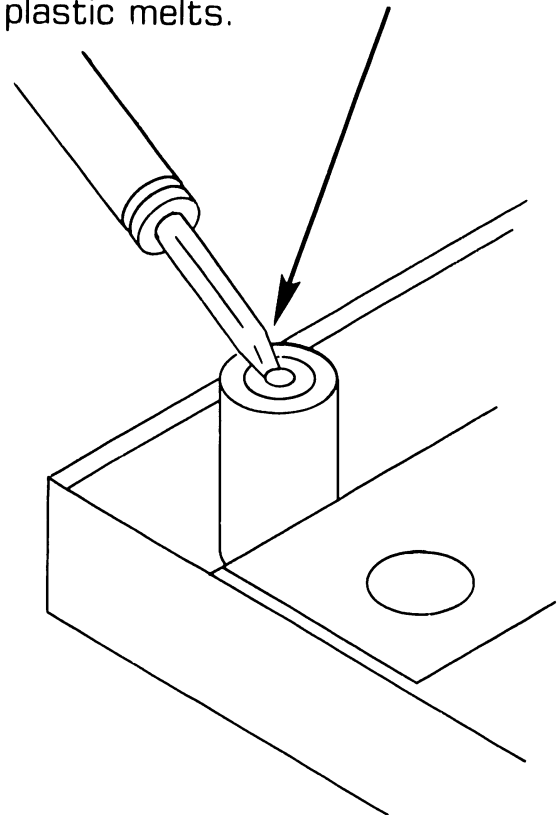

➡ NEXT

7.2.6

Repairing Machine-Inserts (sheet 2 of 2)

CAUTION

Always wear a properly grounded wrist strap whenever any part of the WLTC case is open.

Do *not* use glue of any kind to repair machine-inserts.

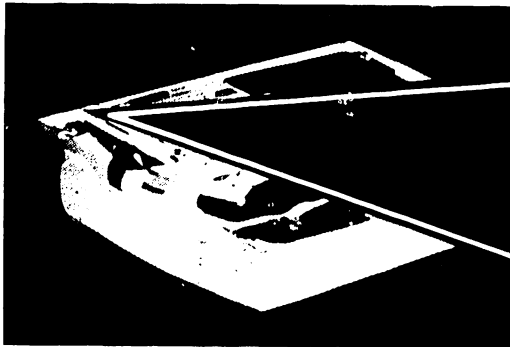

- 3 Remove soldering iron and wait for plastic to cool and harden.

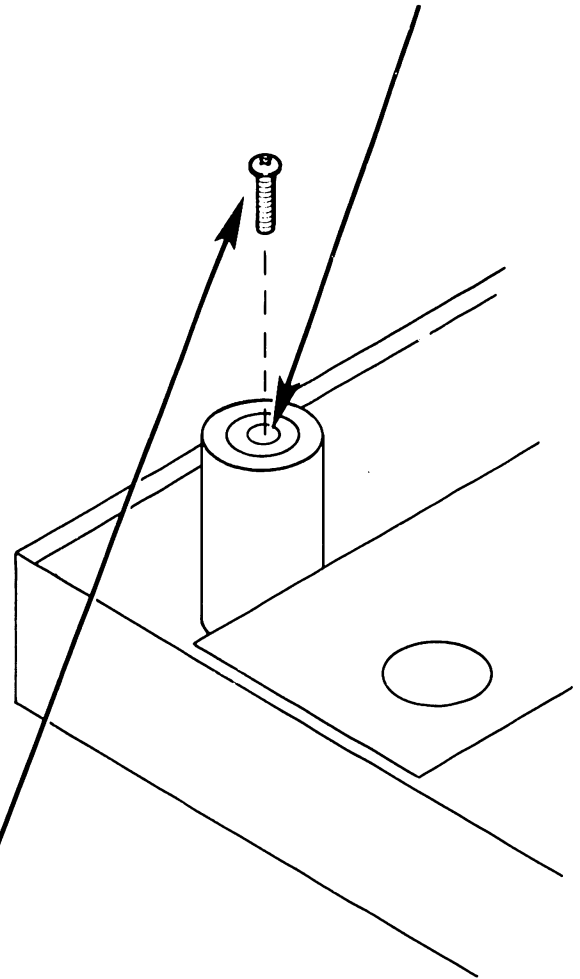

- 4 Test repair by inserting machine screw and tightening.

- 5 Repeat repair, if necessary.

END

7.3.1

Rear Cover

CAUTION

Always wear a properly grounded wrist strap whenever any part of WLTC case is open.

- 1 Snap REAR COVER open by upward thumb pressure against textured pressure points on REAR COVER.

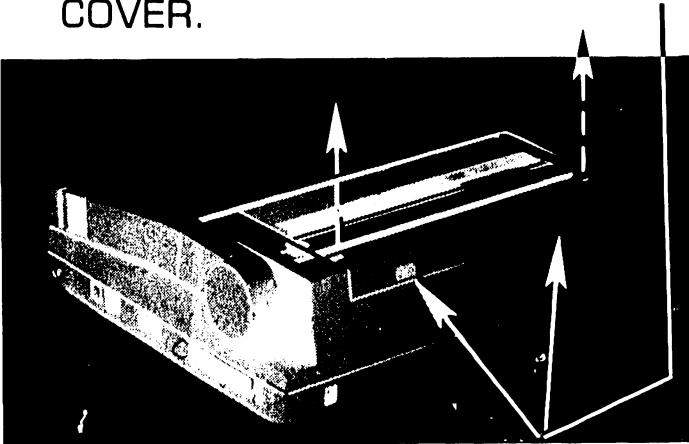

- 2 Swing REAR COVER away from unit, exposing connectors for OPT RAM and MODEM PCBs.

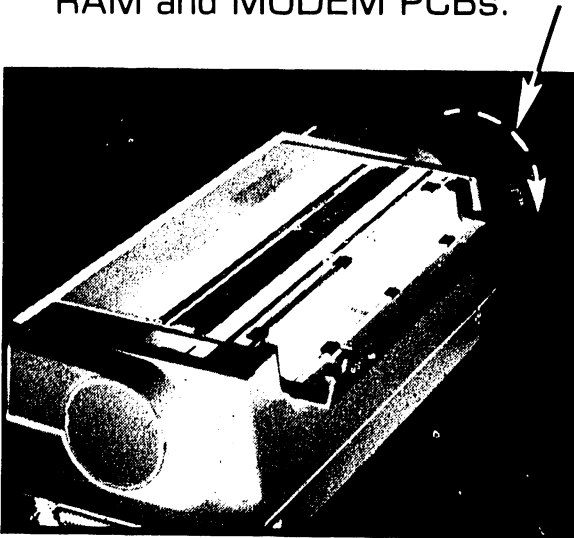

- 3 Lift REAR COVER straight up to remove.

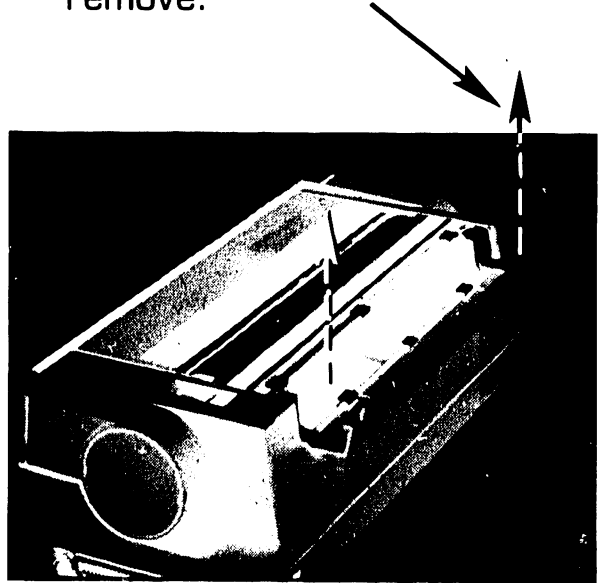

7.3.2 OPT RAM PCB Assembly

CAUTION

Always wear a properly grounded wrist strap whenever any part of WLTC case is open.

The edge connector on MODEM PCB ASSY plugs into MAIN PCB ASSY.

- 1 Remove REAR COVER (➡ 7.3.1).
- 2 Lifting straight up, carefully unplug OPT RAM PCB ASSY.

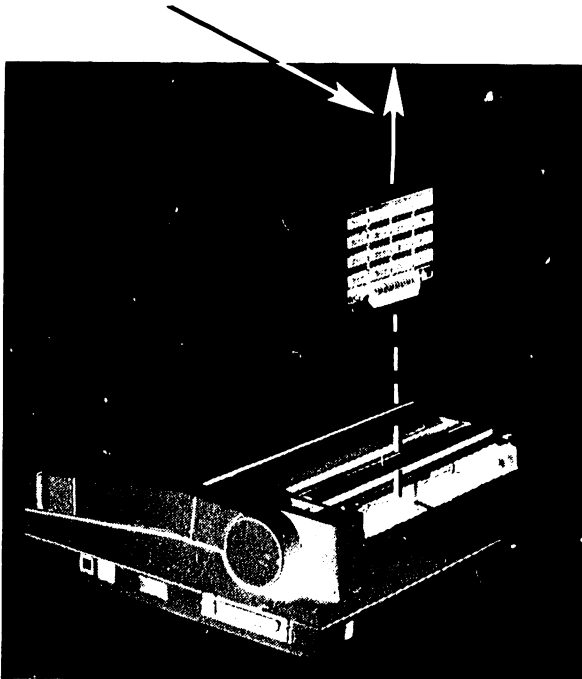

7.3

Removal Procedures

REPAIR

7.3.3 Modem PCB Assembly

CAUTION

Always wear a properly grounded wrist strap whenever any part of WLTC case is open.

The edge connector on MODEM PCB ASSY plugs into MAIN PCB ASSY.

- 1 Remove REAR COVER (➤ 7.3.1).
- 2 Lifting straight up, carefully unplug MODEM PCB ASSY.

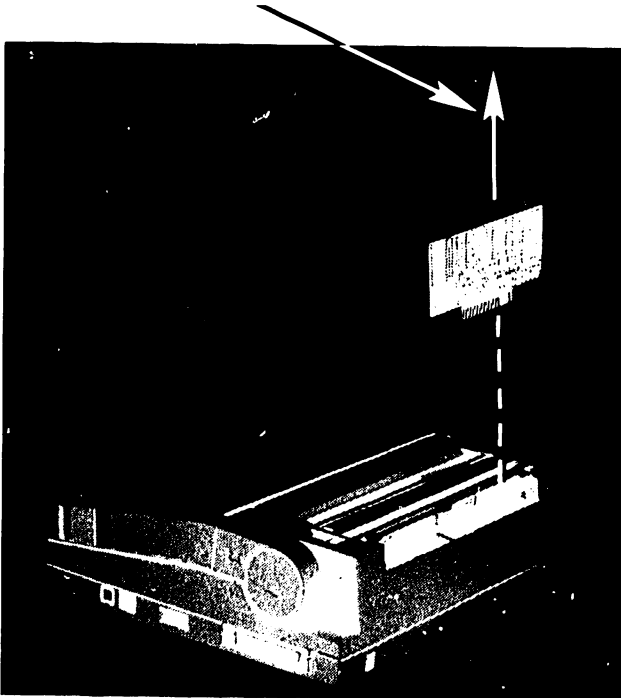

7.3

Removal Procedures

7.3.4

LCD Assembly

CAUTION

Always wear a properly grounded wrist strap whenever any part of WLTC case is open.

The LDC ASSY plugs into LCD ARM R and LCD ARM L. Its connector is located in LCD ARM R and is connected when LCD ASSY is plugged into LCD ARMs. It is locked in place by LCD ARM PRESSURE LEVERS.

- 1** Loosen both LCD ARM PRESSURE LEVERS.

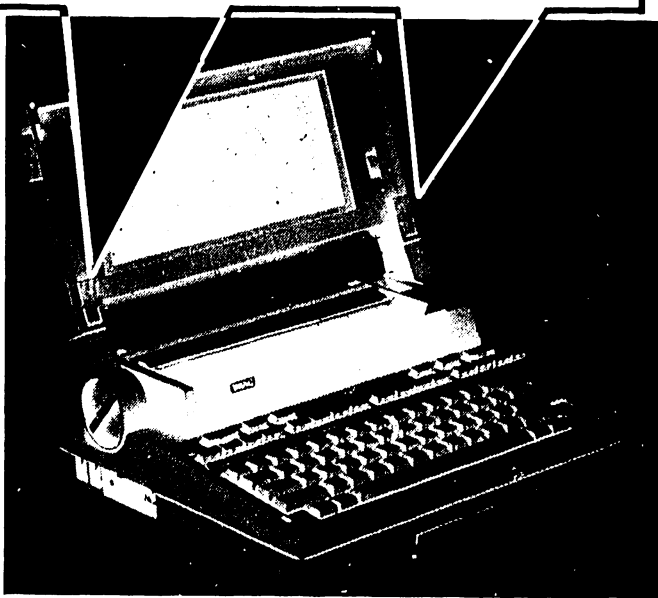

- 2** Lifting straight up on both sides, carefully unplug LCD ASSY.



7.3

Removal Procedures

REPAIR

7.3.5

Battery Cover

CAUTION

Always wear a properly grounded wrist strap whenever any part of WLTC case is open.

The BATTERY COVER encloses and protects NICAD BATT ASSY. It is snap fitted to LOWER CASE.

- 1 Turn unit over to access BATTERY COVER.

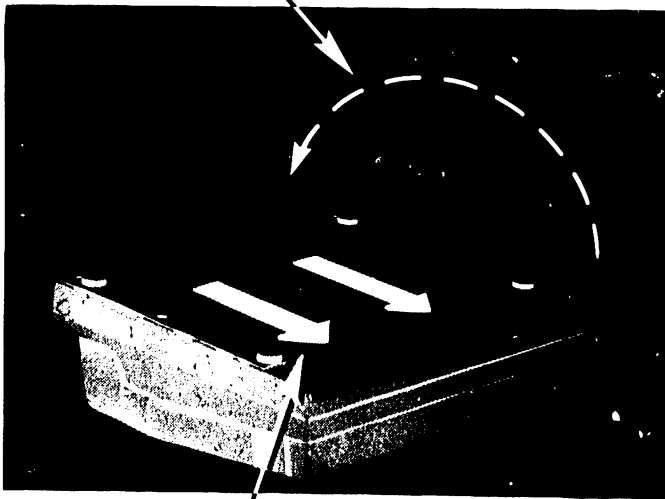

- 2 Snap BATTERY COVER open by thumb pressure against textured pressure points on BATTERY COVER.

7.3

Removal Procedures

REPAIR

7.3.6 NICAD BATT Assembly

CAUTION

Always wear a properly grounded wrist strap whenever any part of WLTC case is open.

The NICAD BATT ASSY fits into LOWER CASE and is enclosed and protected by BATTERY COVER. A 2-wire cable connects to POWER PCB ASSY.

- 1 Turn unit over to access BATTERY COVER.

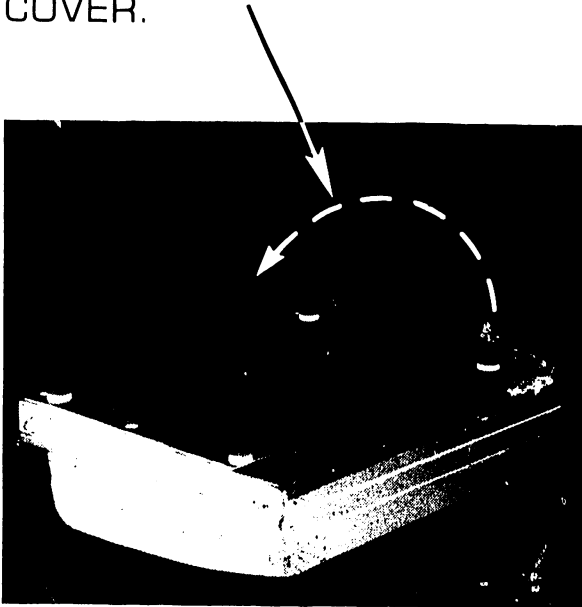

- 3 Lift NICAD BATT ASSY out of compartment enough to expose BATTERY CNN.

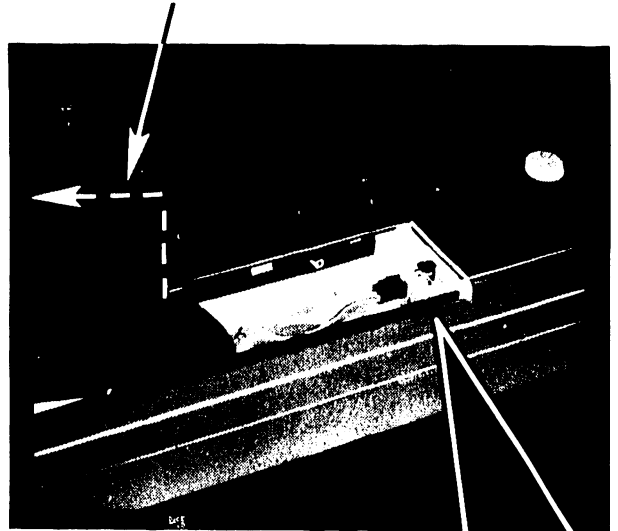

- 2 Remove BATTERY COVER (➔ 7.3.5).

- 4 Unlock and disconnect BATTERY CNN.

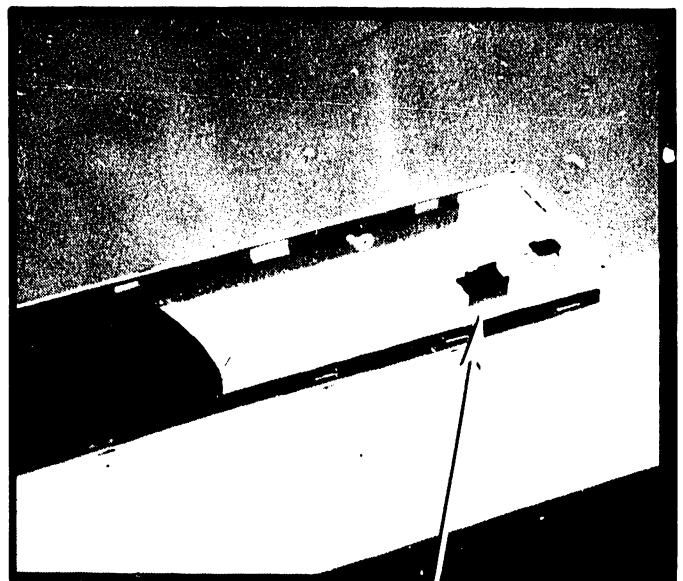

7.3

Removal Procedures

REPAIR

7.3.7

Arm Cap R

CAUTION

Always wear a properly grounded wrist strap whenever any part of WLTC case is open.

ARM CAP R snap fits into LCD ARM R and encloses and protects LCD FPC CABLE.

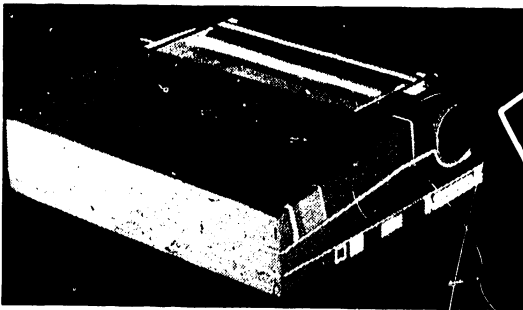

- 1 Carefully fit a thin knife blade or small screwdriver into seam where ARM CAP R joins with LCD ARM R.

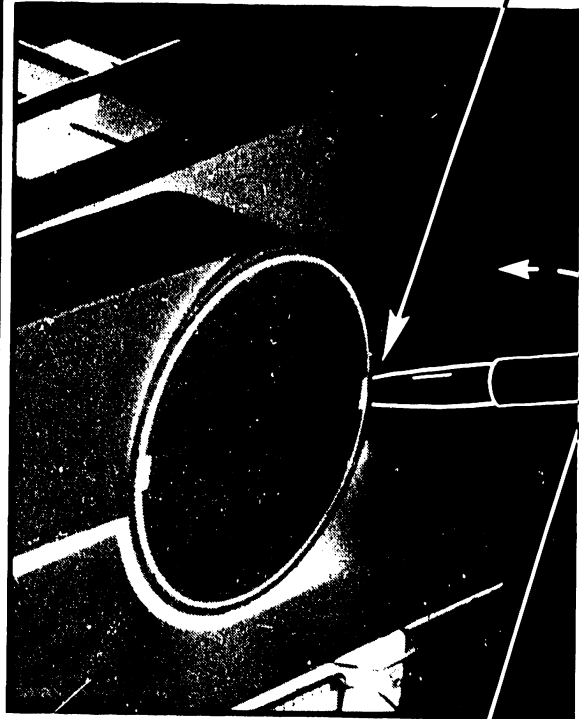

- 2 Pry out ARM CAP R.

7.3

Removal Procedures

REPAIR

7.3.8 Platen Knob Assembly

CAUTION

Always wear a properly grounded wrist strap whenever any part of WLTC case is open.

PLATEN KNOB ASSY friction-fits into LCD ARM L and may be used to turn PLATEN.

- 1 Pull PLATEN KNOB ASSY straight out and away from LCD ARM L.

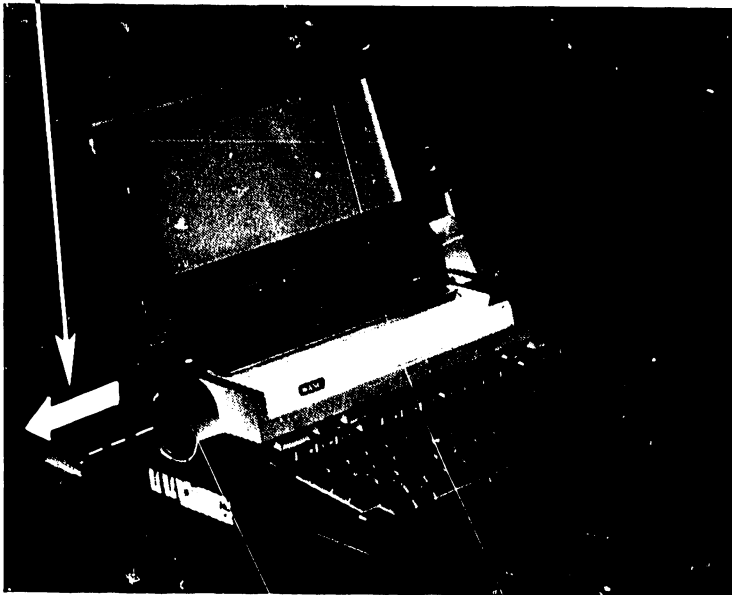

7.3.9

Cassette Cover Assembly

CAUTION

Always wear a properly grounded wrist strap whenever any part of WLTC case is open.

The CASSETTE COVER ASSY snap fits into UPPER CASE. It partially encloses and protects PRINTER ASSY. It may be raised for access to PRINTER ASSY and CASSETTE ASSY.

- 1 Raise CASSETTE COVER ASSY by thumb pressure against textured pressure points on CASSETTE COVER ASSY.

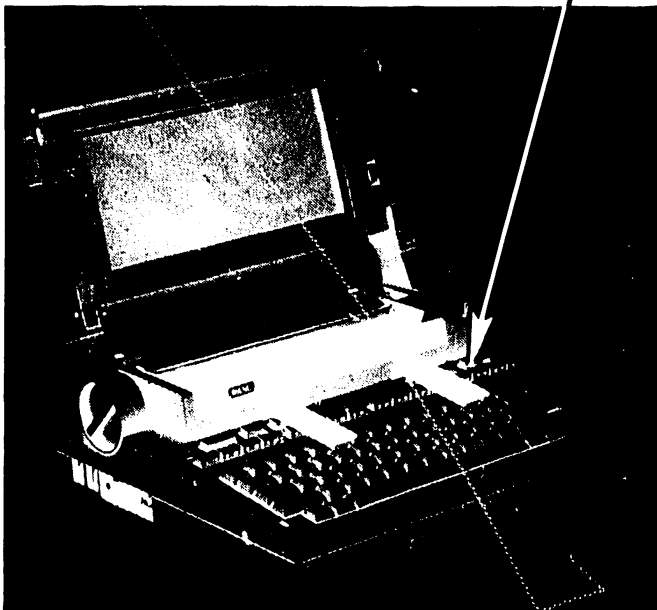

- 2 Gently push against right side (or left) of CASSETTE COVER ASSY to release trunnion.

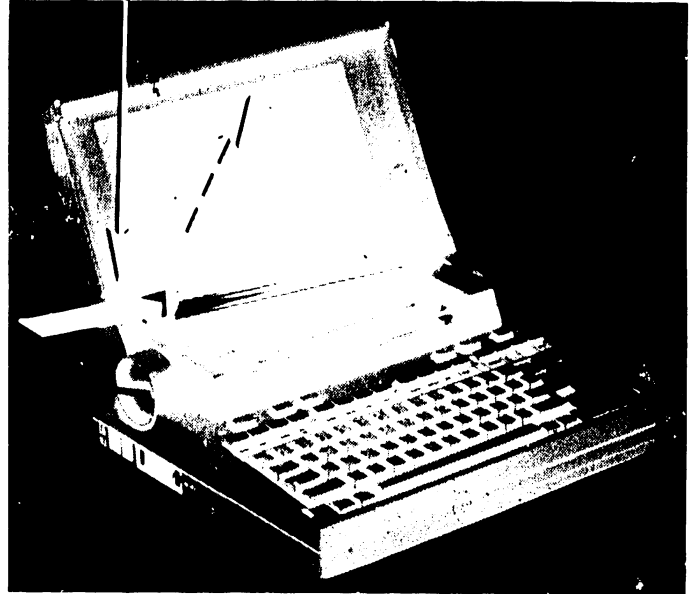

- 3 Release opposite trunnion and lift away.

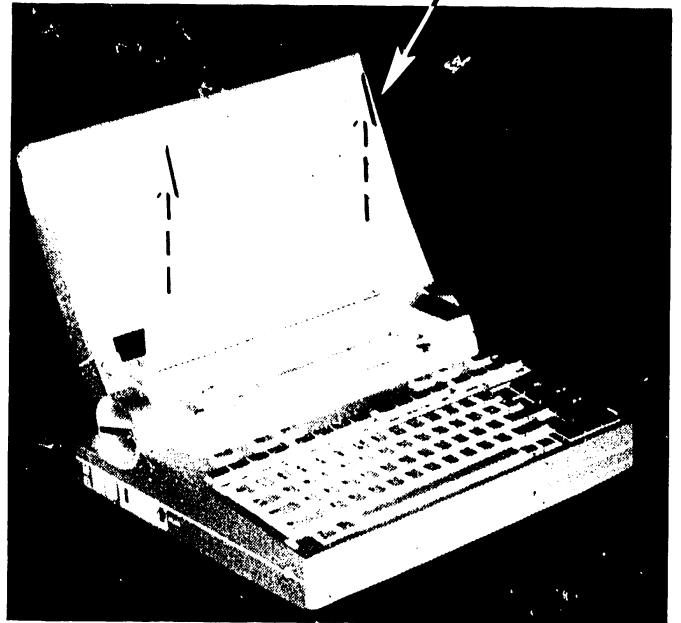

7.3

Removal Procedures

REPAIR

7.3.10 Separating Upper Case from Lower (sheet 1 of 3)

CAUTION

Always wear a properly grounded wrist strap whenever any part of WLTC case is open.

The UPPER CASE is secured to the LOWER by five captive screws and washers, and two screws and washers under the NICAD BATT ASSY. Five cables connect the two halves of the case.

- 1 Turn unit over to access securing screws.

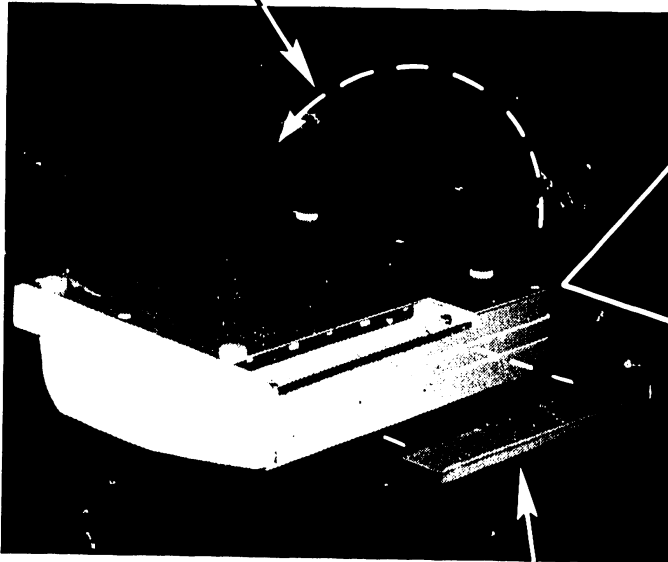

- 3 Disconnect and remove NICAD BATT ASSY to access two screws in that compartment.

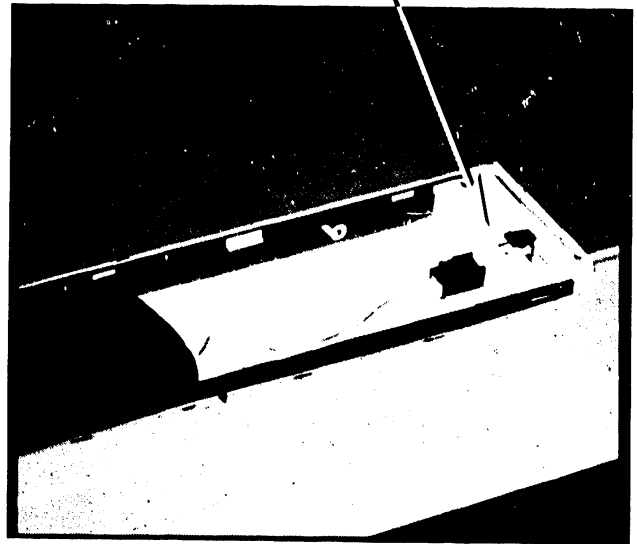

- 2 Open battery compartment.

▶ NEXT

7.3

Removal Procedures

REPAIR

7.3.10

Separating Upper Case from Lower (sheet 2 of 3)

CAUTION

Always wear a properly grounded wrist strap whenever any part of WLTC case is open.

The UPPER CASE is secured to the LOWER by five captive screws and washers, and two screws and washers under the NICAD BATT ASSY. Five cables connect the two halves of the case.

- 4 Loosen five captive screws and remove two in battery compartment.

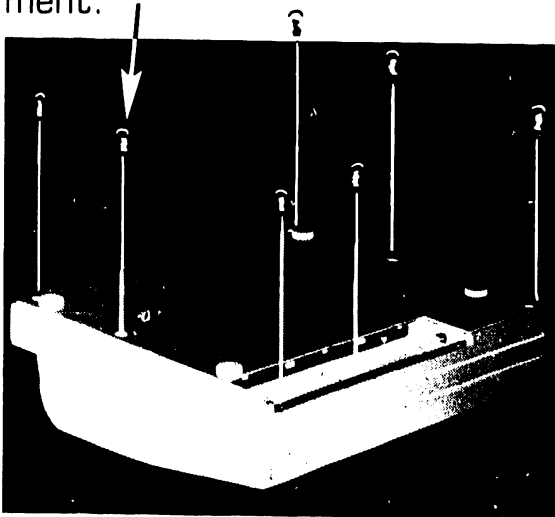

- 5 Turn unit over again.

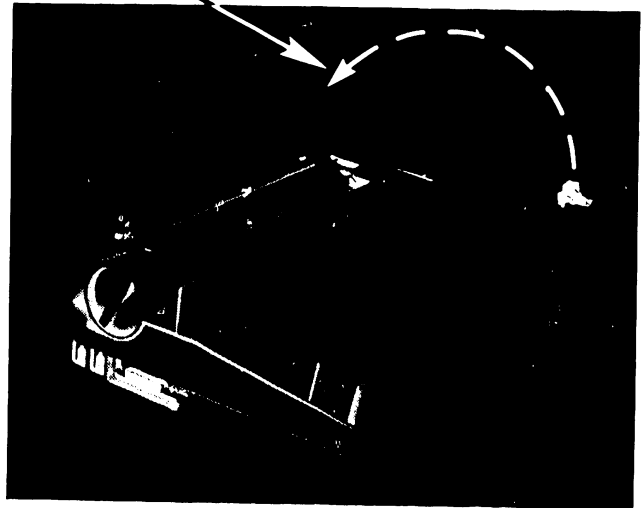

- 6 Swing UPPER CASE up to rest on its side.

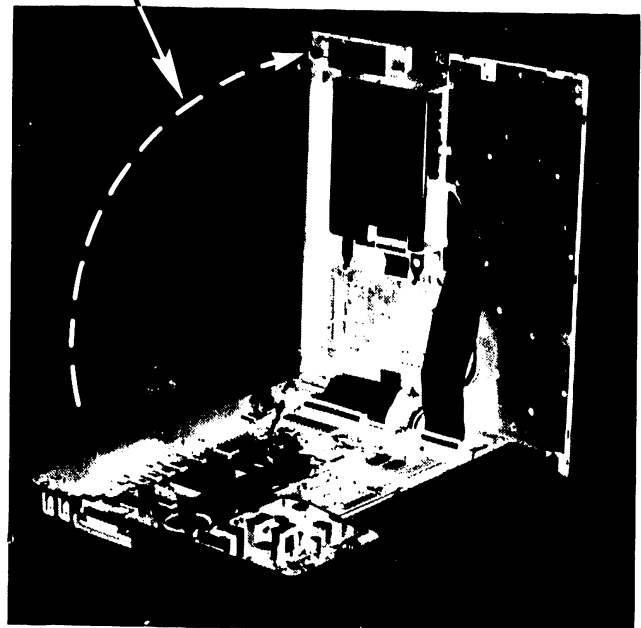

➡NEXT

7.3

Removal Procedures

REPAIR

7.3.10 Separating Upper Case from Lower (sheet 3 of 3)

CAUTION

Always wear a properly grounded wrist strap whenever any part of WLTC case is open.

The UPPER CASE is secured to the LOWER by five captive screws and washers, and two screws and washers under the NICAD BATT ASSY. Five cables connect the two halves of the case.

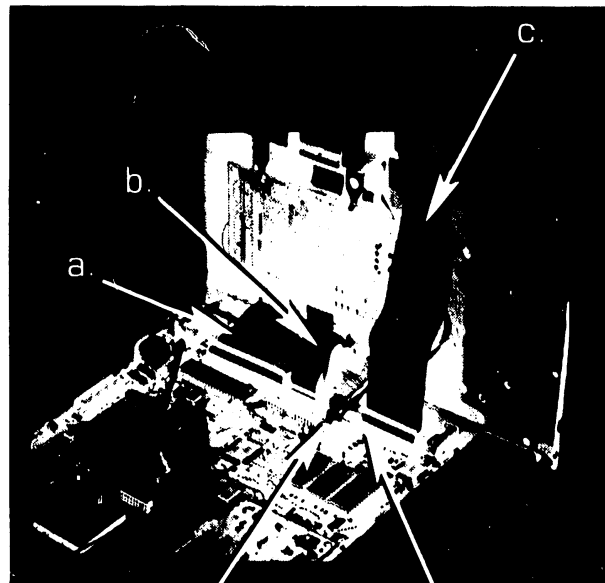
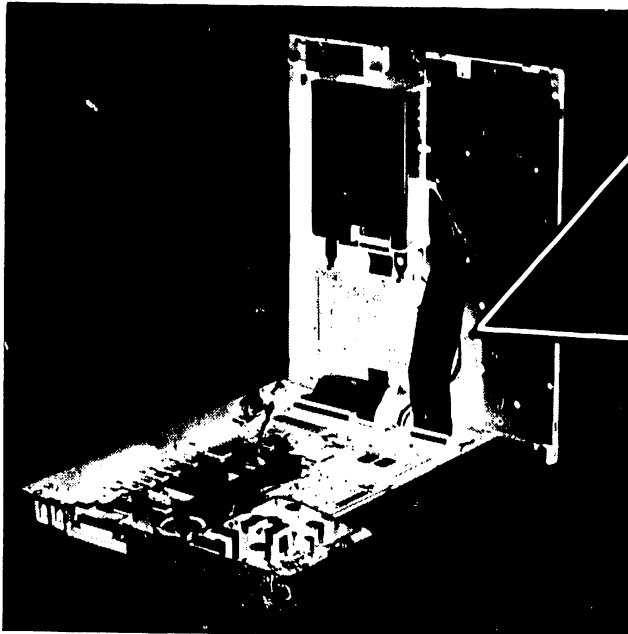

- 7 Disconnect three ribbon cables:
 - a. SCSI CABLE
 - b. PRINTER CABLE
 - c. K/B CABLE
- 8 Disconnect 4-pin HDD CABLE.
- 9 Unlock and unplug ARM FPC CABLE.

◆ END

7.3

Removal Procedures

REPAIR

7.3.10A Earth SP (sheet 1 of 2)

CAUTION

Always wear a properly grounded wrist strap whenever any part of WLTC case is open.

Four "earth springs" (EARTH SP) provide positive contact between FCC plates. The two in LOWER CASE are secured by MAIN PCB ASSY mounting screws. Earth springs in UPPER CASE are secured by mounting screws for HDD and FPC HOLDER.

- 1 Separate UPPER CASE from LOWER (➡ 7.3.10).

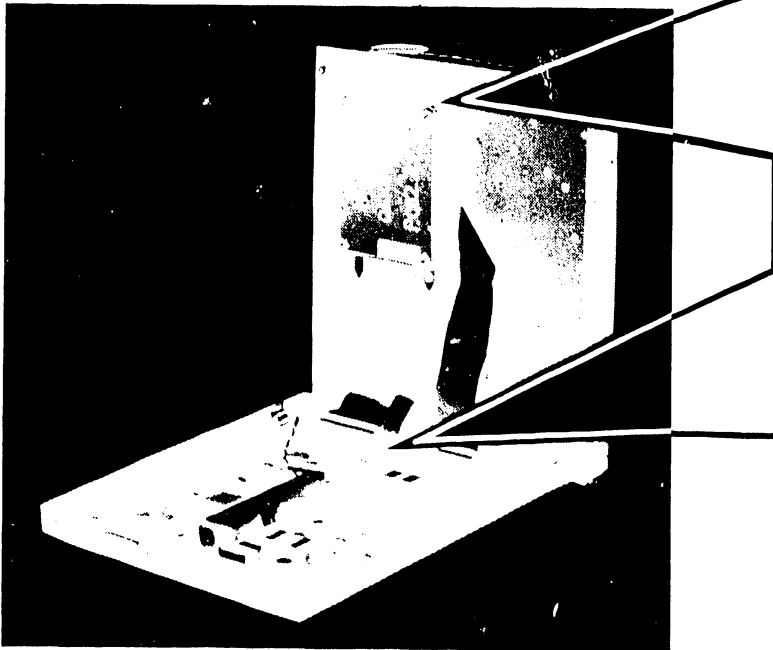

- 2 Remove screws securing EARTH SP K/B.

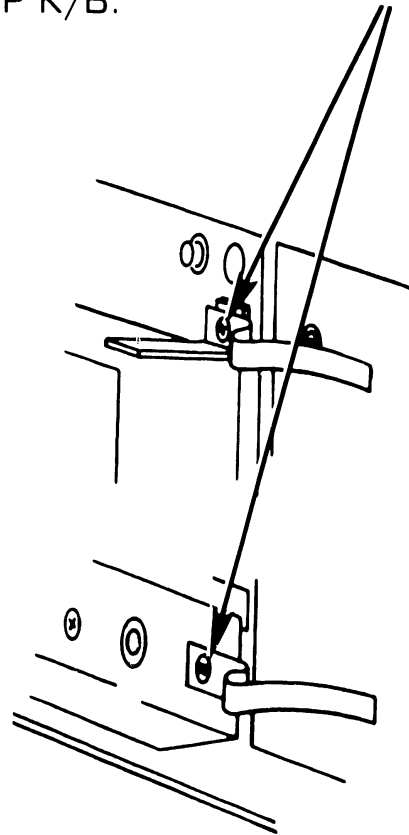

➡ NEXT

7.3

Removal Procedures

REPAIR

7.3.10A Earth SP (sheet 2 of 2)

CAUTION

Always wear a properly grounded wrist strap whenever any part of WLTC case is open.

Four "earth springs" (EARTH SP) provide positive contact between FCC plates. The two in LOWER CASE are secured by MAIN PCB ASSY mounting screws. Earth springs in UPPER CASE are secured by mounting screws for HDD and FPC HOLDER.



- 3 Remove screws securing EARTH SP PH.

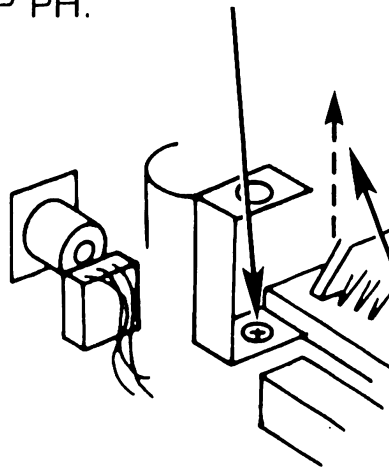

- 4 Remove screws securing EARTH SP HDD ASSY.

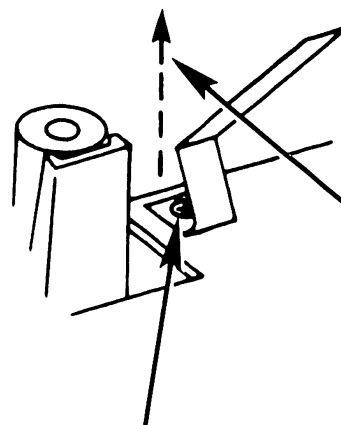

- 5 Lift earth springs away from WLTC.

◆END

7.3

Removal Procedures

REPAIR

7.3.11

Reset Button

CAUTION

Always wear a properly grounded wrist strap whenever any part of WLTC case is open.

The RESET BUTTON is friction-fitted onto the actuating lever of the RESET SWITCH and may be removed without removing other parts of the WLTC.

- 1 Separate UPPER CASE from LOWER (➡7.2.10).

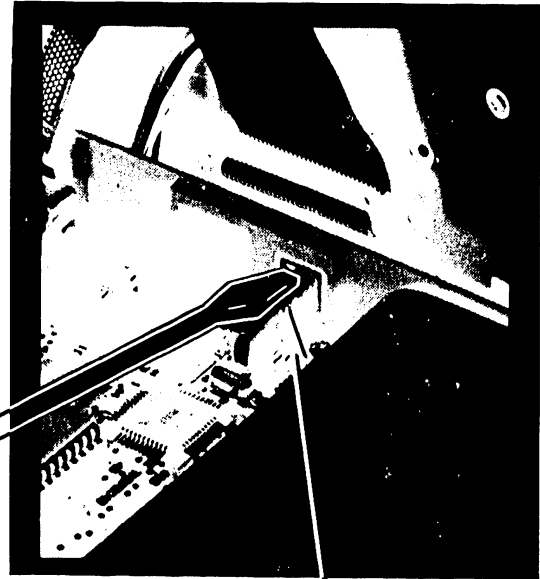

- 2 Carefully push RESET BUTTON away from RESET SWITCH, using a small, flat screwdriver.

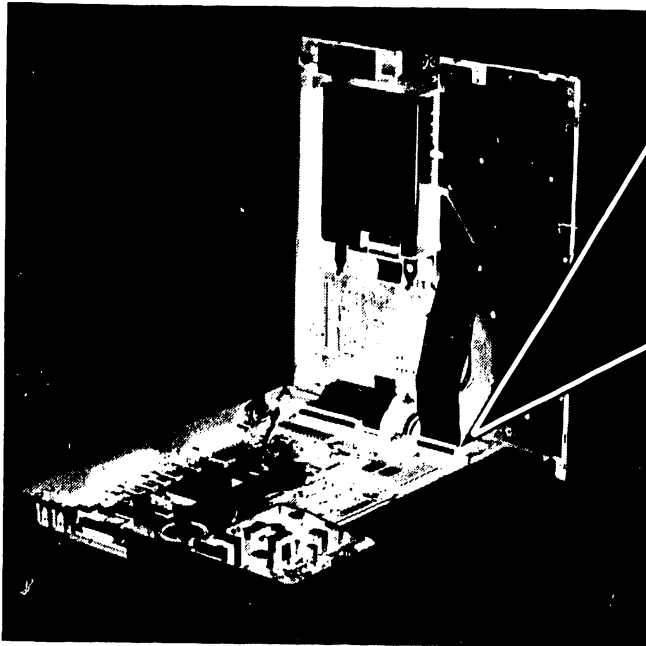

7.3

Removal Procedures

REPAIR

7.3.12

STD RAM PCB

CAUTION

Always wear a properly grounded wrist strap whenever any part of WLTC case is open.

The STD RAM PCB is supported on one edge by its connection with MAIN PCB, the opposite edge is supported by a lip on SUB BATT ASSY. Two screws secure STD RAM PCB.

1 Separate UPPER CASE from LOWER (➡ 7.2.10).

2 Remove two securing screws.

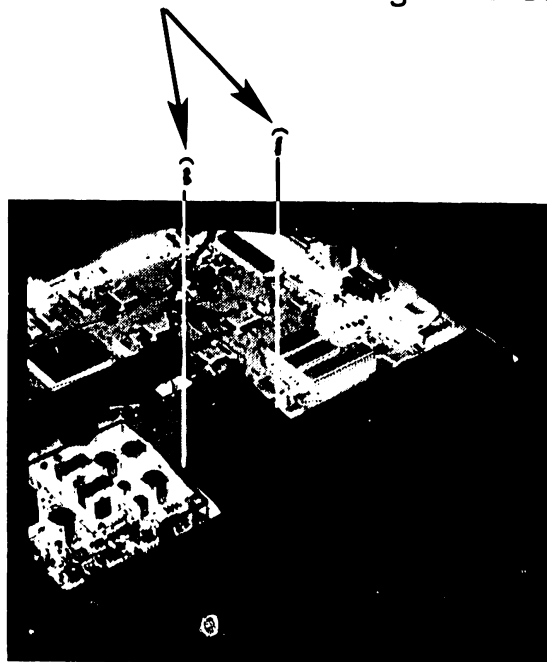

3 Carefully unplug STD RAM PCB from MAIN PCB ASSY.

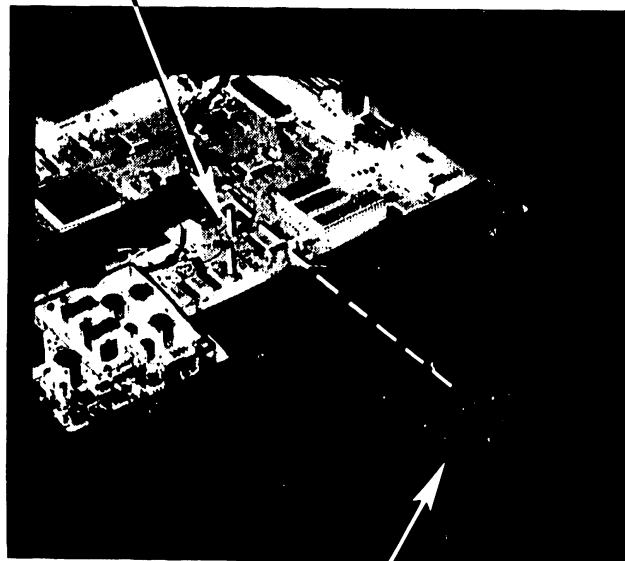

4 Lift STD RAM PCB out and away from lip on SUB BATT ASSY.

7.3

Removal Procedures

REPAIR

7.3.13

Sub Batt Assembly

CAUTION

Always wear a properly grounded wrist strap whenever any part of WLTC case is open.

The SUB BATT ASSY is fastened to MAIN PCB by one screw and a tab which fits into a notch in edge of MAIN PCB. Two cables connect to MAIN PCB.

- 1 Separate UPPER CASE from LOWER (▶ 7.3.10).
- 2 Remove STD RAM PCB (▶ 7.3.12).

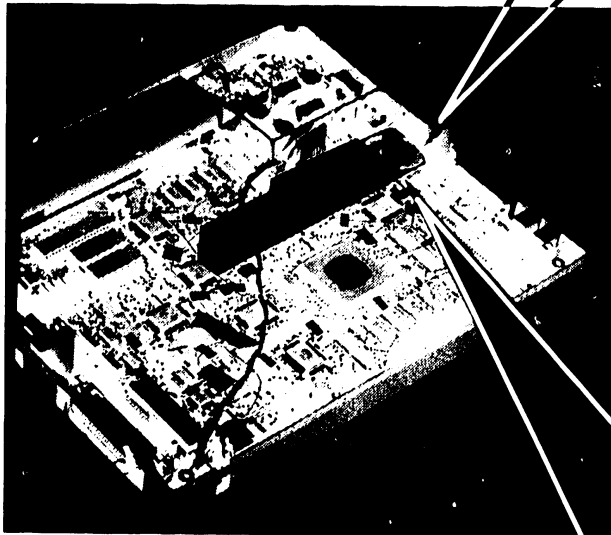

- 3 Disconnect two cables:
(▶ 7.2.3).

- a. BATT CABLE
- b. SPEAKER CABLE

- 4 Remove single screw.

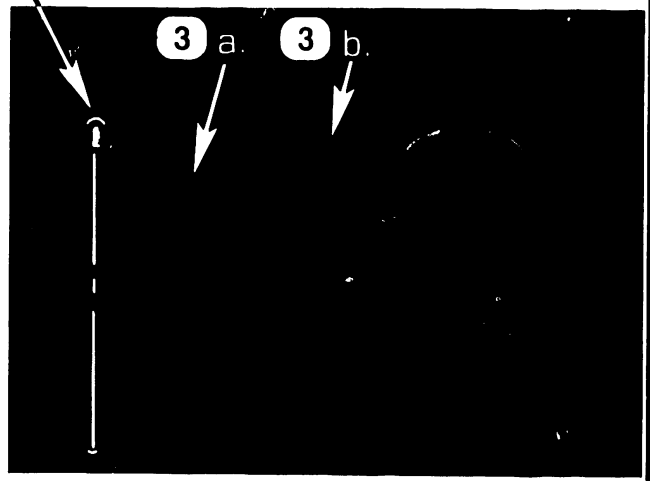

- 5 Disengage tab by pushing SUB BATT ASSY toward edge of LOWER CASE.

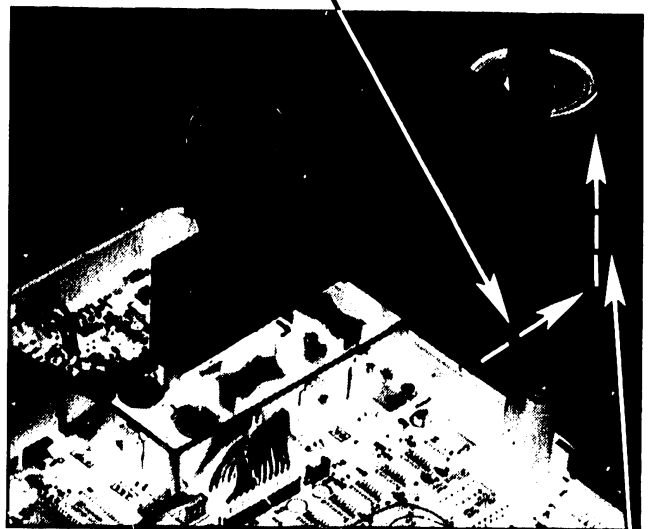

- 6 Lift SUB BATT ASSY free of LOWER CASE.

7.3

Removal Procedures

REPAIR

7.3.14 Power PCB Assembly

CAUTION

Always wear a properly grounded wrist strap whenever any part of WLTC case is open.

The POWER PCB ASSY is fastened to LOWER CASE by two screws. A 12-wire HARNESS ASSY and a 3-wire HARNESS ASSY connect to MAIN PCB. The NICAD BATT ASSY plugs into the POWER PCB ASSY.

- 1 Separate UPPER CASE from LOWER (▶ 7.3.10).
- 2 Remove STD RAM ASSY (▶ 7.3.12).
- 3 Remove SUB BATT ASSY (▶ 7.3.13).
- 4 Disconnect two cables:
(▶ 7.2.3).
 - a. 12-wire HARNESS ASSY
 - b. 3-wire HARNESS ASSY

- 5 Remove two screws.

- 6 Taking care to clear NICAD BATT Connector, lift POWER PCB ASSY clear of guide pin and remove from case.

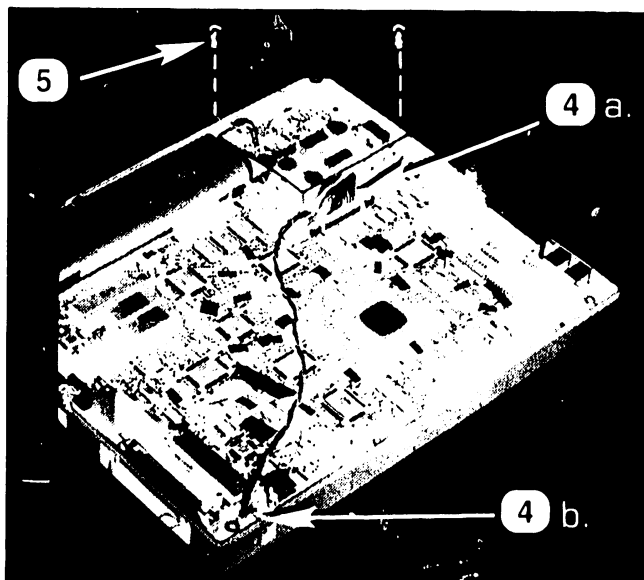
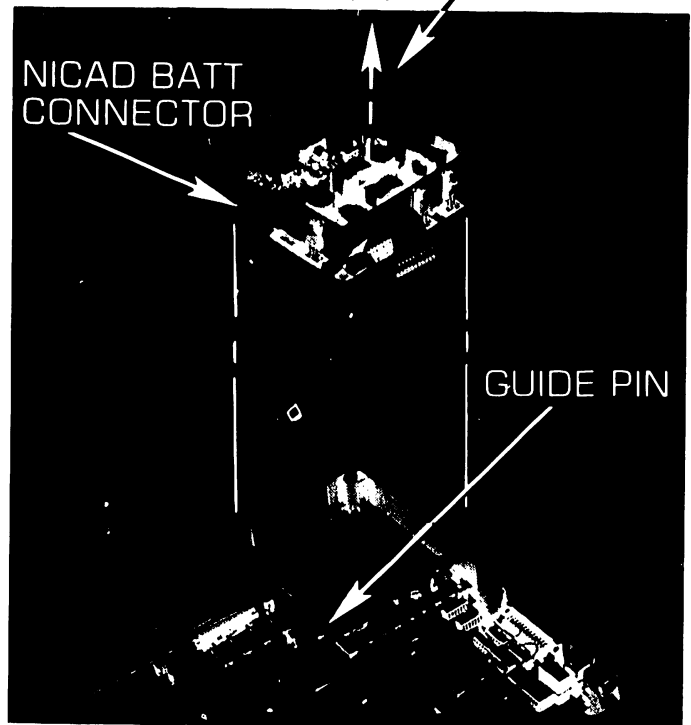

7.3

Removal Procedures

REPAIR

7.3.15 Main PCB (sheet 1 of 2)

CAUTION

Always wear a properly grounded wrist strap whenever any part of WLTC case is open.

The MAIN PCB is fastened to LOWER CASE by ten screws. Two cables connect to POWER PCB ASSY. Cables also connect to:

- HDD PCB(SCSI)
- K/B FULL ASSY
- LCD ASSY, and
- PRINTER PCB
- SUB BATT ASSY

The STD RAM PCB and SUB BATT ASSY mount on MAIN PCB.

- 1 Separate UPPER CASE from LOWER (▶ 7.3.10).
- 2 Remove STD RAM ASSY (▶ 7.3.12).
- 3 Remove SUB BATT ASSY (▶ 7.3.13).

- 4 Disconnect two cables:
(▶ 7.2.3).
 - a. 12-wire HARNESS ASSY
 - b. 3-wire HARNESS ASSY
- 4 A. Remove EARTH SP PH and E. SP HDD ASSY (▶ 7.3.10A).
- 5 Remove remaining seven screws.

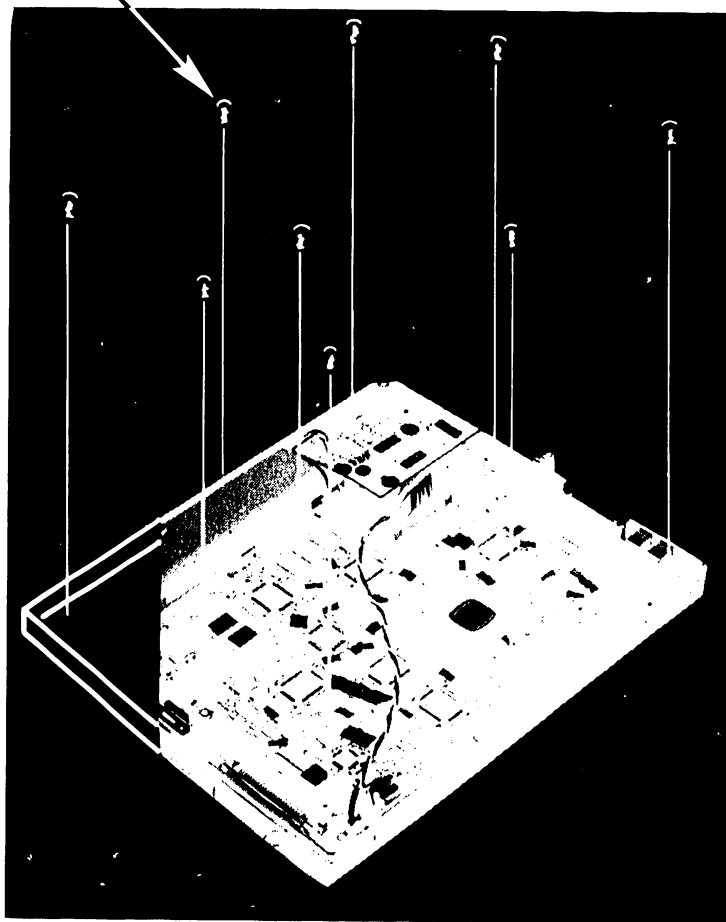

NOTE

It is not necessary to remove POWER PCB ASSY in order to remove MAIN PCB.

▶NEXT

7.3

Removal Procedures

REPAIR

7.3.15 Main PCB (sheet 2 of 2)

CAUTION

Always wear a properly grounded wrist strap whenever any part of WLTC case is open.

- 7 Lift side of MAIN PCB opposite SCSI connector and slide SCSI connector free of LOWER CASE.

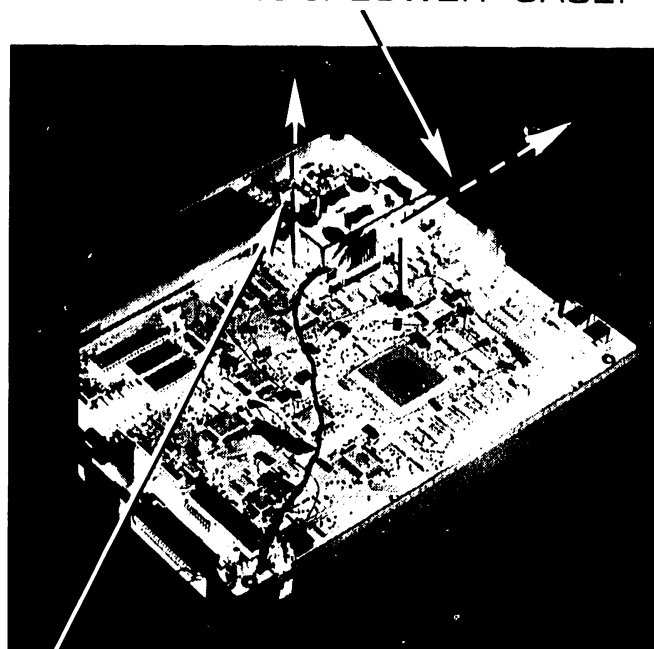

- 8 Lift MAIN PCB free of LOWER CASE.

- 9 Remove RESET BUTTON COVER (▶ 7.3.11).

- 10 Save RESET BUTTON COVER to reinstall on replacement MAIN PCB ASSY.

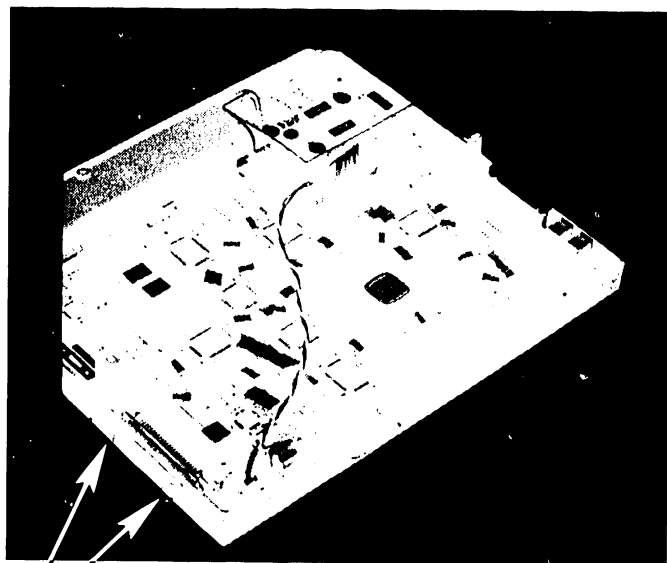

- 6 Fold inward the wire "ears" on SCSI connector.

◆ END

7.3

Removal Procedures

REPAIR

7.3.16 Lower Case

CAUTION

Always wear a properly grounded wrist strap whenever any part of WLTC case is open.

The LOWER CASE is only the molded plastic unit: All other items are removed.

6 Lift out FCC PLATE.

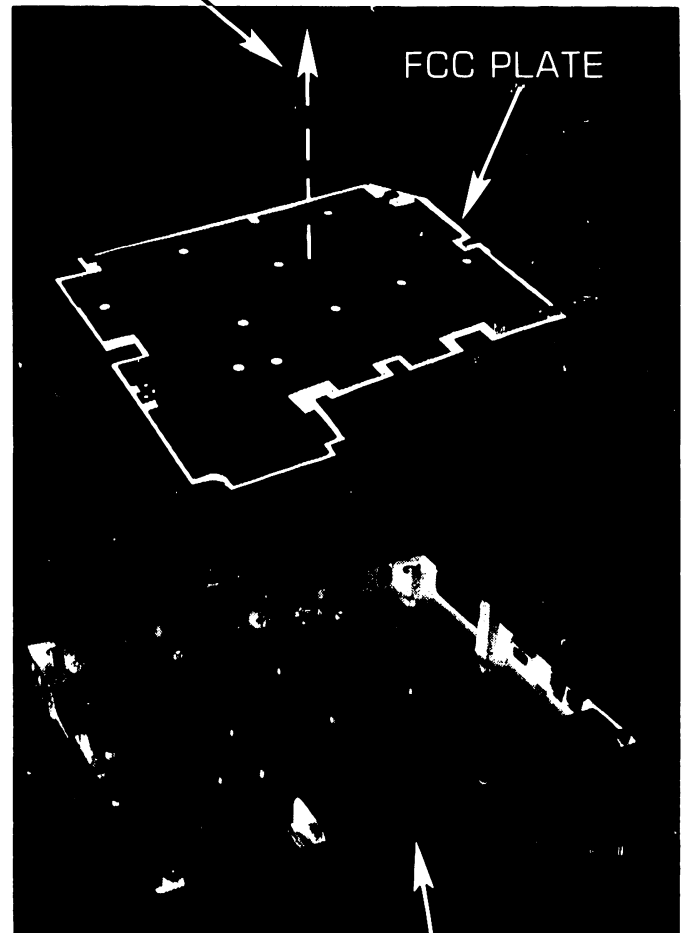

1 Separate UPPER CASE from LOWER (➡ 7.3.10).

2 Remove STD RAM ASSY (➡ 7.3.12).

3 Remove SUB BATT ASSY (➡ 7.3.13).

4 Remove MAIN PCB ASSY (➡ 7.3.15).

5 Remove POWER PCB ASSY (➡ 7.3.14).

LOWER CASE

7.3

Removal Procedures

REPAIR

7.3.17 HDD PCB (SCSI) (sheet 1 of 2)

CAUTION

Always wear a properly grounded wrist strap whenever any part of WLTC case is open.

The HDD PCB (SCSI) is fastened to flanges on HDD ASSY by two screws and to a standoff on PRINTER ASSY FRAME by one screw. Cable connections are:

- a. HDD CABLE 26 connects to HDD ASSY
- b. HDD CABLE 50 and HDD POWER CABLE 4-PIN connects to MAIN PCB ASSY.

- 1 Separate UPPER CASE from LOWER (➡ 7.3.10).

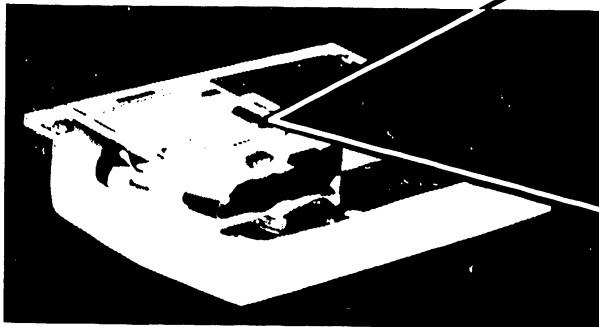

- 2 Loosen two screws attaching HDD PCB to HDD.

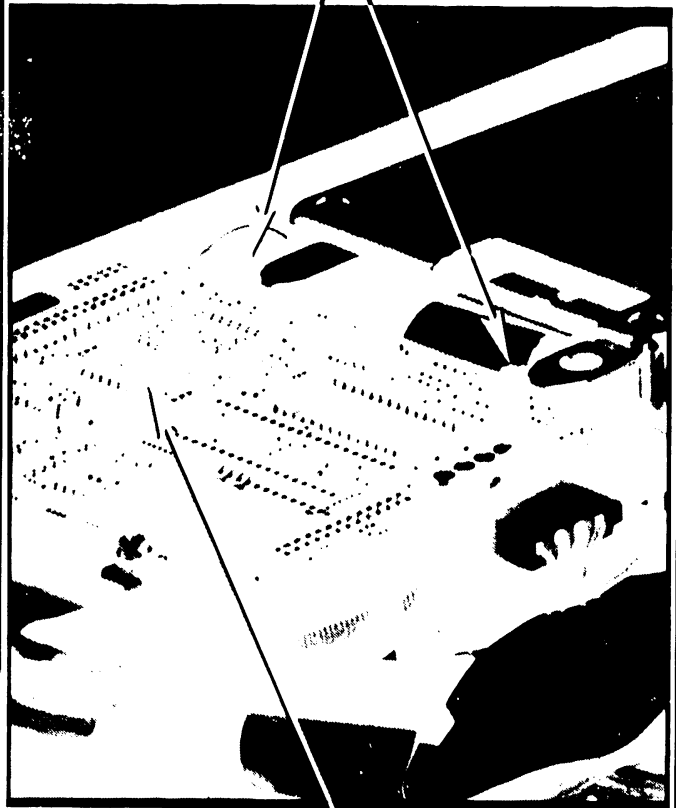

- 3 Remove third screw.

➡NEXT

7.3

Removal Procedures

REPAIR

7.3.17

HDD PCB (SCSI) (sheet 2 of 2)

CAUTION

Always wear a properly grounded wrist strap whenever any part of WLTC case is open.

The HDD PCB (SCSI) is fastened to flanges on HDD ASSY by two screws and to a standoff on PRINTER ASSY FRAME by one screw. Cable connections are:

- a. HDD CABLE 26 connects to HDD ASSY
- b. HDD CABLE 50 and HDD POWER CABLE 4-PIN connects to MAIN PCB ASSY.

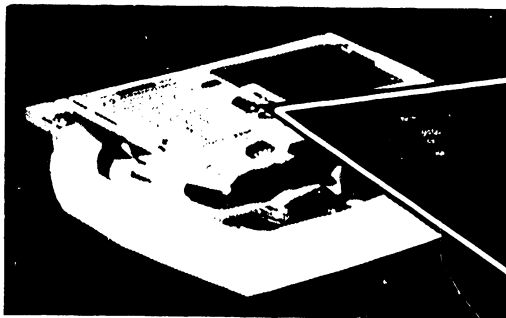

- 4 Slide HDD PCB away from HDD.

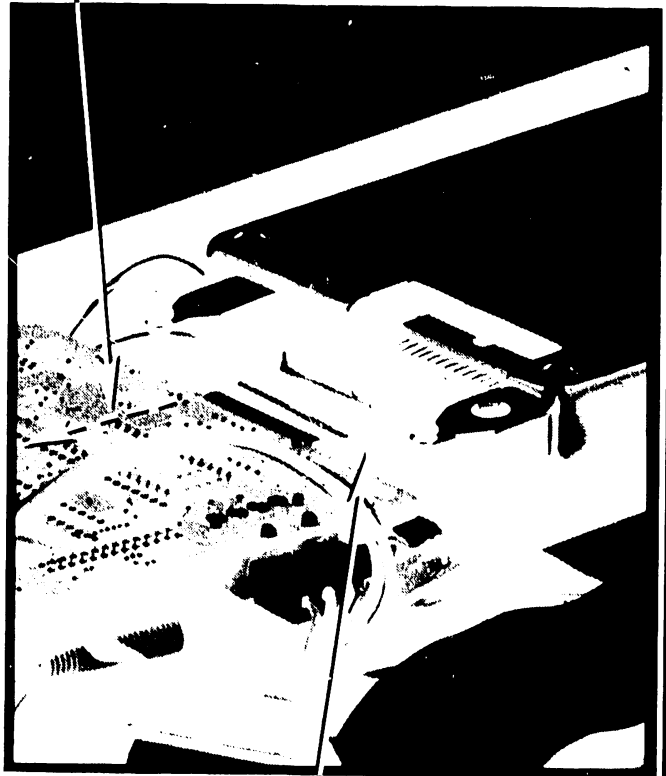

- 5 Disconnect HDD CABLE 26.

- 6 Lift HDD PCB away from WLTC.

● END

7.3

Removal Procedures

REPAIR

7.3.18

HDD Cable 26

CAUTION

Always wear a properly grounded wrist strap whenever any part of WLTC case is open.

HDD CABLE 26 plugs into component side of HDD PCB (SCSI) and connects to HDD ASSY.

- 1 Separate UPPER CASE from LOWER (➡ 7.3.10).
- 2 Remove HDD PCB (SCSI) (➡ 7.3.17).

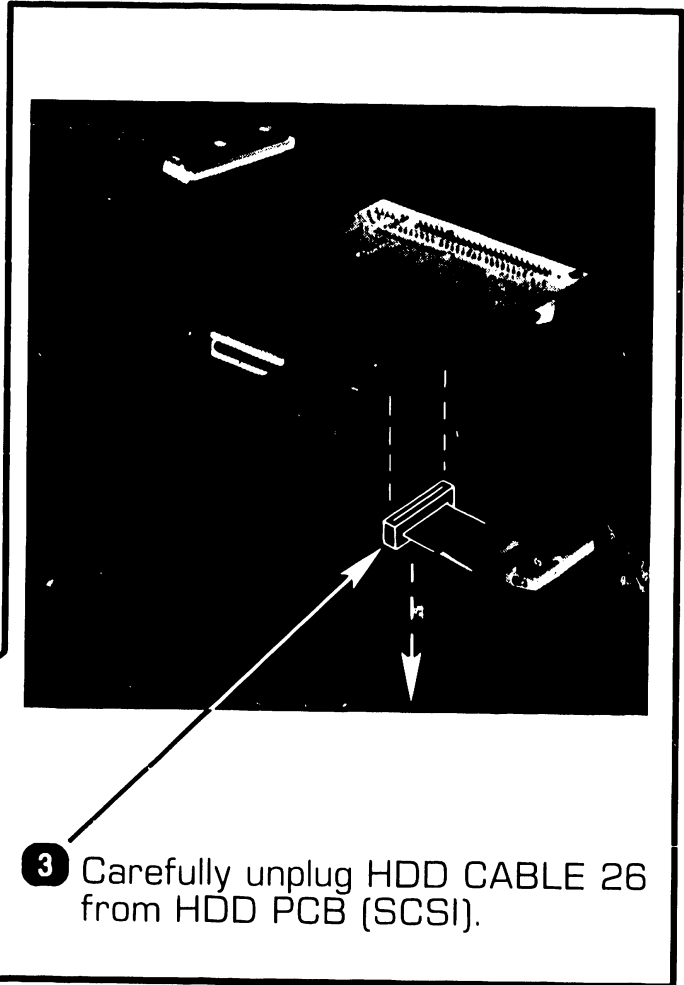

- 3 Carefully unplug HDD CABLE 26 from HDD PCB (SCSI).

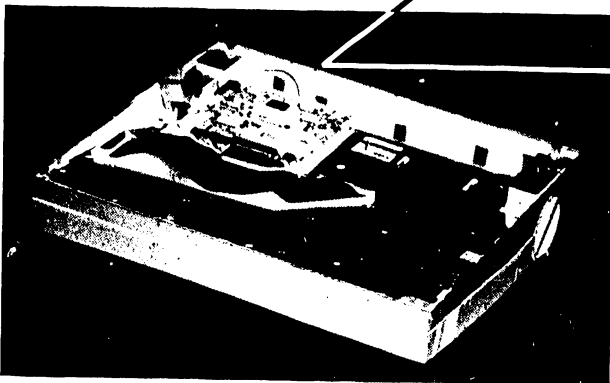

7.3

Removal Procedures

REPAIR

7.3.19

HDD Cable 50

CAUTION

Always wear a properly grounded wrist strap whenever any part of WLTC case is open.

HDD CABLE 50 plugs into component side of HDD PCB (SCSI) and connects to HDD ASSY.

- 1 Separate UPPER CASE from LOWER (➤ 7.3.10).
- 2 Remove HDD PCB (SCSI) (➤ 7.3.17).

- 3 Carefully unplug HDD CABLE 50 from HDD PCB (SCSI).

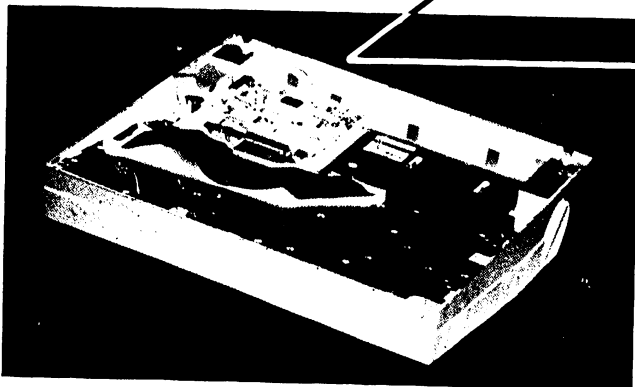
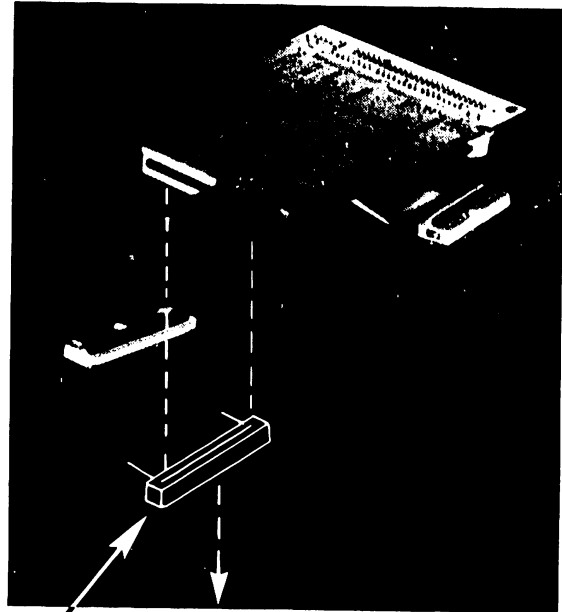

7.3

Removal Procedures

REPAIR

7.3.20 HDD Power Cable 4-Pin

CAUTION

Always wear a properly grounded wrist strap whenever any part of WLTC case is open.

HDD POWER CABLE 4-PIN plugs into component side of HDD PCB (SCSI) and connects to MAIN PCB ASSY.

Notice that it is not necessary to remove HDD PCB (SCSI) nor completely separate UPPER CASE from LOWER, to remove HDD POWER CABLE 4-PIN.

- 1 Separate UPPER CASE from LOWER (▶ 7.3.10).

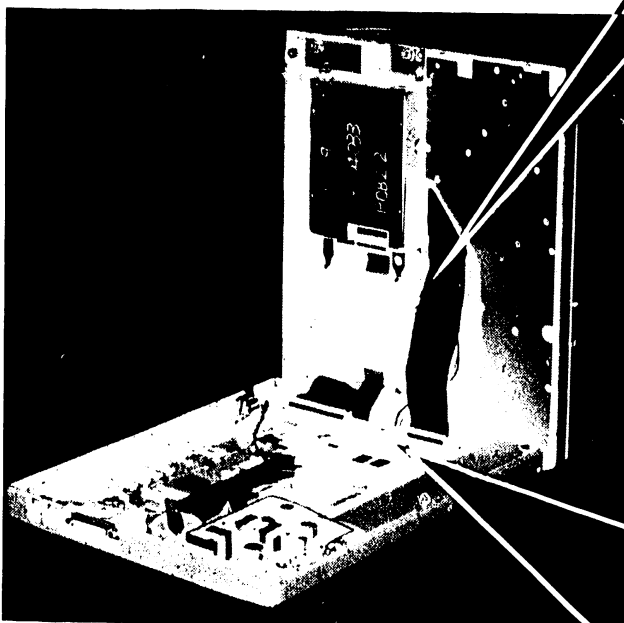

- 2 Disconnect HDD POWER CABLE 4-PIN at HDD PCB (SCSI).

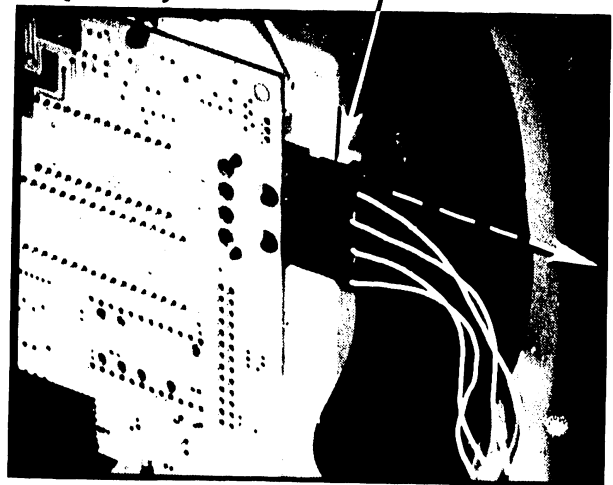

- 3 Disconnect HDD POWER CABLE 4-PIN at MAIN PCB ASSY.

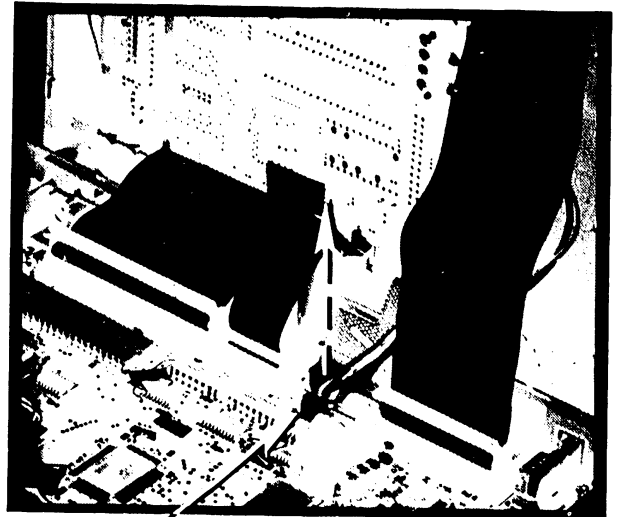

7.3

Removal Procedures

REPAIR

7.3.21 Printer PCB Assembly (sheet 1 of 2)

CAUTION

Always wear a properly grounded wrist strap whenever any part of WLTC case is open.

The PRINTER PCB ASSY is positioned on PRINTER ASSY FRAME by three, notched, standoff tabs and fastened in place by one screw. One ribbon cable connects to MAIN PCB; five cable assemblies and one FPC cable connect to PRINTER ASSY:

Ribbon cable to MAIN PCB (P1)
Power cable (P2)
PAPER END sensor cable (P3)
LF-MOTOR cable (P4)
DR-MOTOR cable (P5)
HD-MOTOR cable (P6)
FPC CABLE to PRINTER ASSY (P7)

4 Disconnect five mini-connector cables from PRINTER ASSY: (➡ 7.2.3).

- a. Power cable
- b. PAPER END sensor cable
- c. LF-MOTOR cable
- d. DR-MOTOR cable
- e. HD-MOTOR cable.

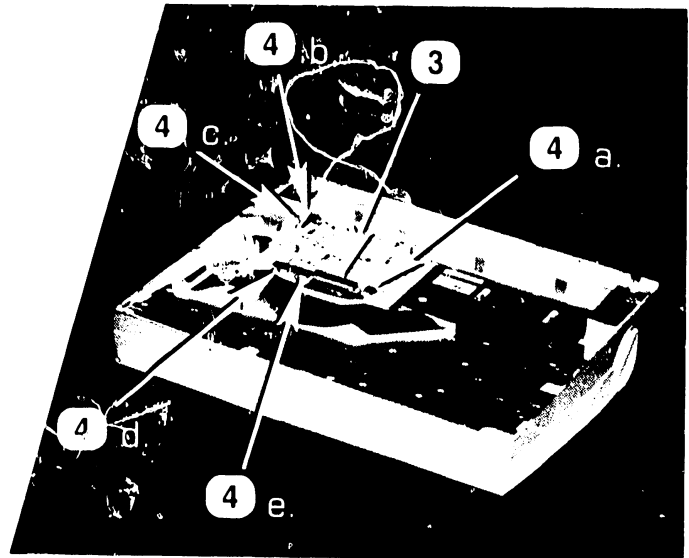

1 Separate UPPER CASE from LOWER (➡ 7.3.10).

2 Remove HDD PCB (SCSI) (➡ 7.3.17).

3 Unlock and disconnect FPC CABLE from PRINTER ASSY (➡ 7.2.1).

➡ NEXT

7.3

Removal Procedures

REPAIR

7.3.21

Printer PCB Assembly (sheet 2 of 2)

5 Remove screw.

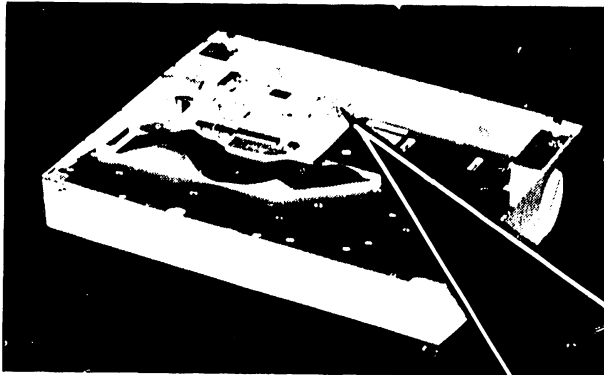

6 Slide PRINTER PCB ASSY toward rear of UPPER CASE to clear notches in standoffs.

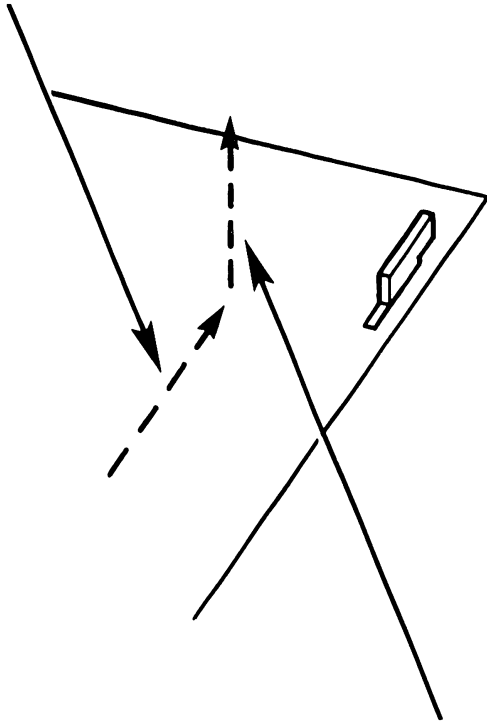

7 Lift PRINTER PCB ASSY clear of PRINTER ASSY.

● END

7.3

Removal Procedures

REPAIR

7.3.22 HDD Assembly

CAUTION

Always wear a properly grounded wrist strap whenever any part of WLTC case is open.

The HDD ASSY is fastened to PRINTER ASSY FRAME by four screws. One ribbon cable connects to HDD PCB (SCSI).

Notice that HDD ASSY may be removed without first removing HDD PCB ASSY or PRINTER PCB ASSY. Notice also that HDD ASSY and HDD PCB ASSY may be removed as a unit. The procedure described here first removes HDD PCB ASSY. Other removal sequences are obvious.

- 4 Remove three remaining screws.

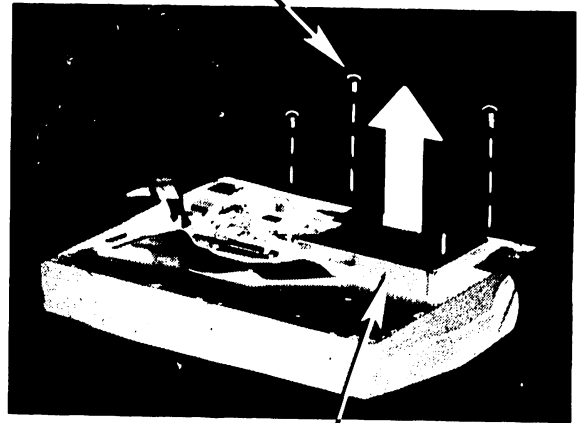

- 5 Lift HDD ASSY clear of PRINTER ASSY FRAME.

- 1 Separate UPPER CASE from LOWER (▶ 7.3.10).

- 2 Remove HDD PCB (SCSI) (▶ 7.3.17).

- 3 Remove EARTH SP K/B (▶ 7.3.10A).

7.3

Removal Procedures

REPAIR

7.3.23 Printer Assembly

CAUTION

Always wear a properly grounded wrist strap whenever any part of WLTC case is open.

The PRINTER ASSY is fastened to UPPER CASE by three shoulder screws and two screws securing FPC HOLDER. Five cable assemblies and one FPC cable connect to PRINTER PCB ASSY.

- 1 Remove PLATEN KNOB ASSY (➤ 7.3.8).
- 2 Separate UPPER CASE from LOWER (➤ 7.3.10).
- 3 Remove HDD PCB (SCSI) (➤ 7.3.17).
- 4 Remove PRINTER PCB ASSY (➤ 7.3.18).
- 5 Remove LCD FPC HOLDER (➤ 7.3.10A).
- 6 Remove HDD Assy. (➤ 7.3.22).

- 7 Remove SHOULDER SCREWS and washers.

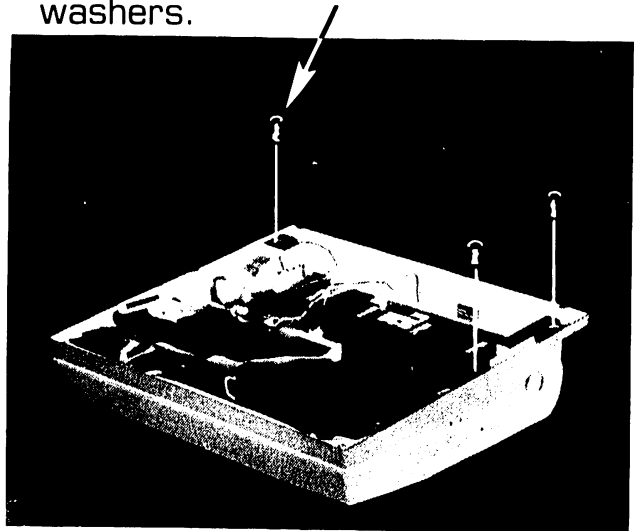

- 8 Lift LCD FPC side of PRINTER ASSY and carefully slide away from PLATEN KNOB.

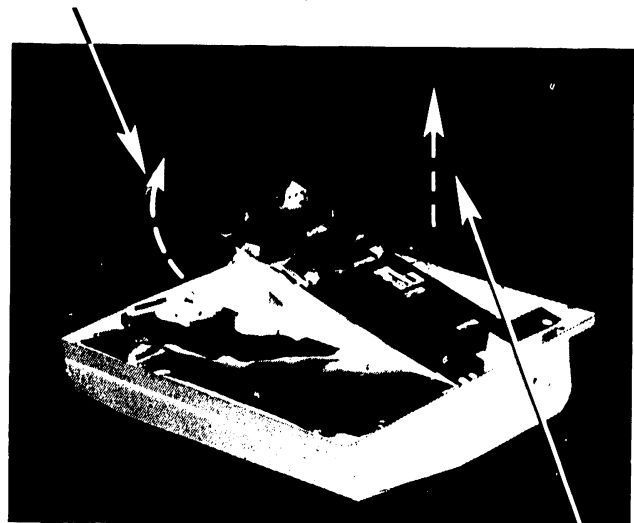

- 9 Lift PRINTER ASSY away from UPPER CASE.

7.3

Removal Procedures

REPAIR

7.3.24 K/B Full Assembly

CAUTION

Always wear a properly grounded wrist strap whenever any part of WLTC case is open.

The K/B FULL ASSY consists of K/B ASSY and UPPER CASE.

- 1 Remove REAR COVER (➤ 7.3.1).
- 2 Remove LCD ASSY (➤ 7.3.4).
- 3 Remove ARM CAP R (➤ 7.3.7).
- 4 Remove PLATEN KNOB ASSY (➤ 7.3.8).
- 5 Remove CASSETTE COVER ASSY. (➤ 7.3.9).
- 6 Separate UPPER CASE from LOWER (➤ 7.3.10).
- 7 Remove HDD PCB (SCSI) (➤ 7.3.17).
- 8 Remove PRINTER PCB ASSY (➤ 7.3.18).
- 9 Remove HDD ASSY (➤ 7.3.22).
- 10 Remove PRINTER ASSY (➤ 7.3.23).
- 11 K/B FULL ASSY is what remains.

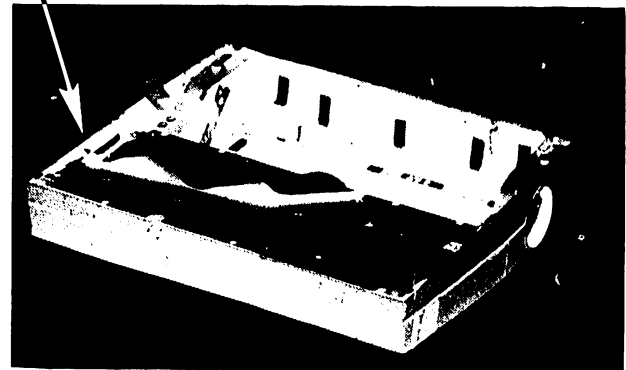

(UNDERSIDE)

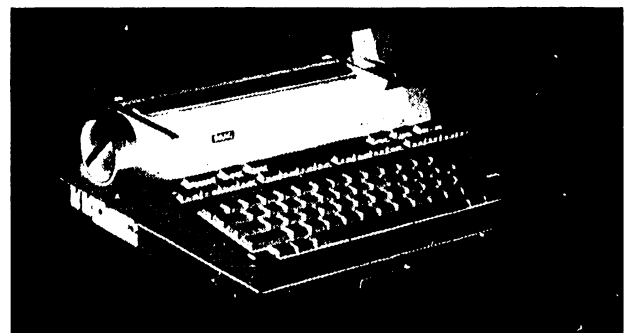

(UPPERSIDE)

NOTE

Steps 7, 8, 9, and 10 may be combined into a single step and the four assemblies removed as a unit.

7.4

Reinstallation Procedures

REPAIR

7.4.1 Rear Cover

CAUTION

Always wear a properly grounded wrist strap whenever any part of WLTC case is open.

The REAR COVER encloses and protects OPT RAM PCB ASSY, MODEM PCB ASSY, or their connectors. It is snap fitted to UPPER CASE and can be swung away to hang on UPPER CASE when PCB ASSYs are being removed or installed.

- 1 Hook REAR COVER onto rear of unit.

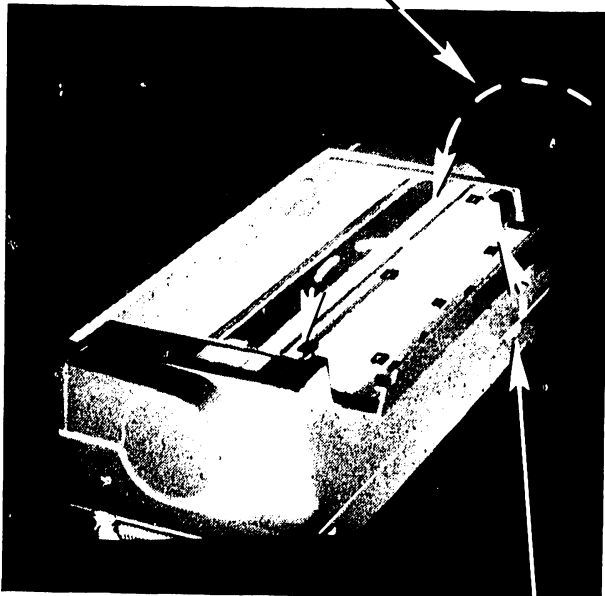

- 2 Swing REAR COVER out toward unit, enclosing connectors for OPT RAM and MODEM PCBs.

- 3 Snap REAR COVER downward by gentle pressure near textured pressure points on REAR COVER.

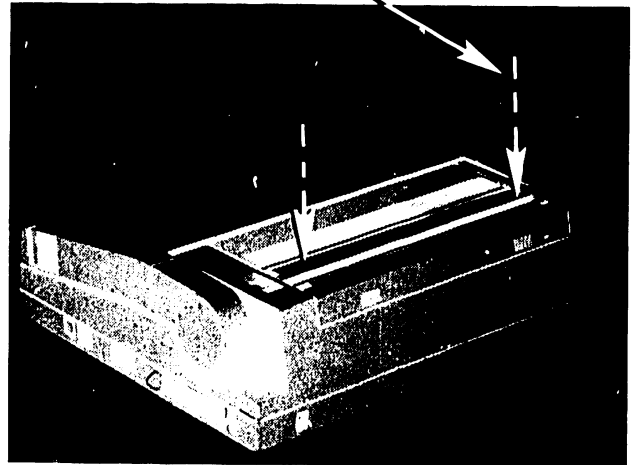

7.4

Reinstallation Procedures

REPAIR

7.4.2 OPT RAM PCB Assembly

CAUTION

Always wear a properly grounded wrist strap whenever any part of WLTC case is open.

The edge connector on OPT RAM PCB ASSY plugs into MAIN PCB ASSY.

- 1 Remove REAR COVER (➡ 7.3.1).

CAUTION

Do not remove anti-static bag from OPT RAM PCB ASSY until installation is complete.

- 2 Without removing anti-static bag, carefully plug OPT RAM PCB ASSY into mating connector on MAIN PCB ASSY.

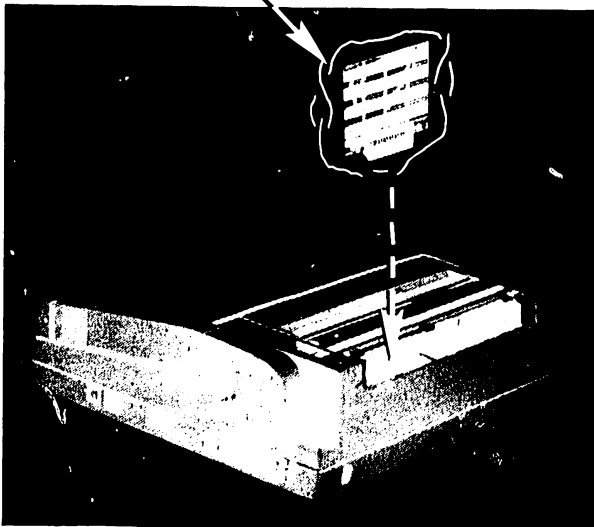

- 3 Remove anti-static bag from OPT RAM PCB ASSY.

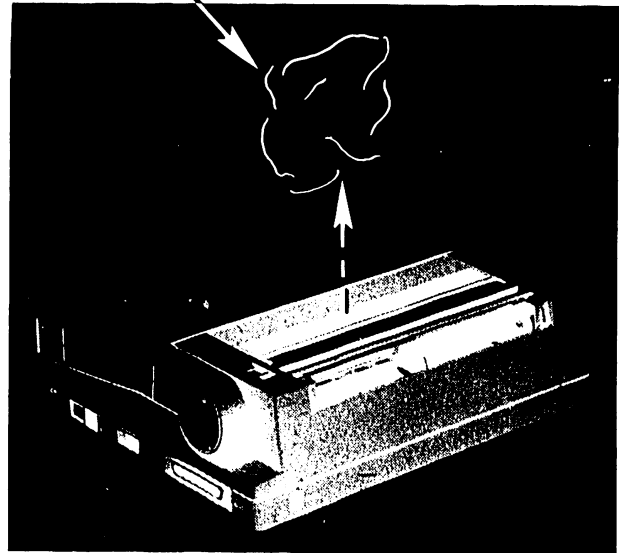

- 4 Reinstall REAR COVER (➡ 7.4.1).

7.4

Reinstallation Procedures

REPAIR

7.4.3 Modem PCB Assembly

CAUTION

Always wear a properly grounded wrist strap whenever any part of WLTC case is open.

The edge connector on MODEM PCB ASSY plugs into MAIN PCB ASSY.

- 1 Remove REAR COVER (➡ 7.3.1).

CAUTION

Do not remove anti-static bag from MODEM PCB ASSY until installation is complete.

- 2 Without removing anti-static bag, carefully plug MODEM PCB ASSY into mating connector on MAIN PCB ASSY.

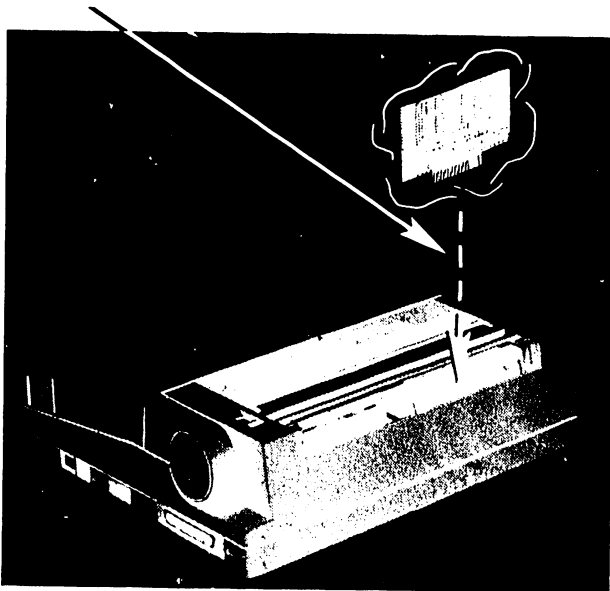

- 3 Remove anti-static bag from MODEM PCB ASSY.

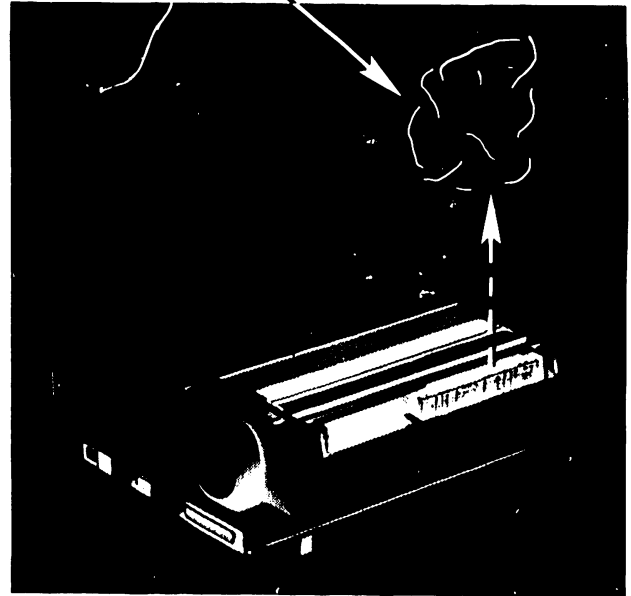

- 4 Reinstall REAR COVER.

7.4

Reinstallation Procedures

REPAIR

7.4.4 LCD Assembly

CAUTION

Always wear a properly grounded wrist strap whenever any part of WLTC case is open.

- 3 If necessary, adjust LCD ARM PRESSURE PLATE (➡ 8.2).

The LDC ASSY plugs into LCD ARM R and LCD ARM L. Its connector is located in LCD ARM R and is connected when LCD ASSY is plugged into LCD ARMs. It is locked in place by LCD ARM PRESSURE LEVERS.

- 1 Keeping LCD ASSY aligned with LCD ARMs, plug LCD ASSY into LCD ARMs.

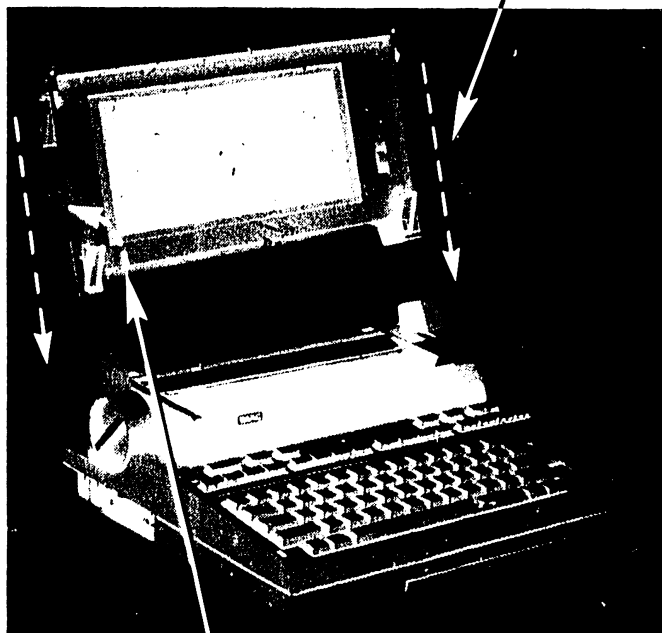

- 2 Close both LCD ARM PRESSURE LEVERS.

7.4

Reinstallation Procedures

REPAIR

7.4.5 Battery Cover

CAUTION

Always wear a properly grounded wrist strap whenever any part of WLTC case is open.

The BATTERY COVER encloses and protects NICAD BATT ASSY. It is snap fitted to LOWER CASE.

- 1 Turn unit over to access BATTERY COVER.

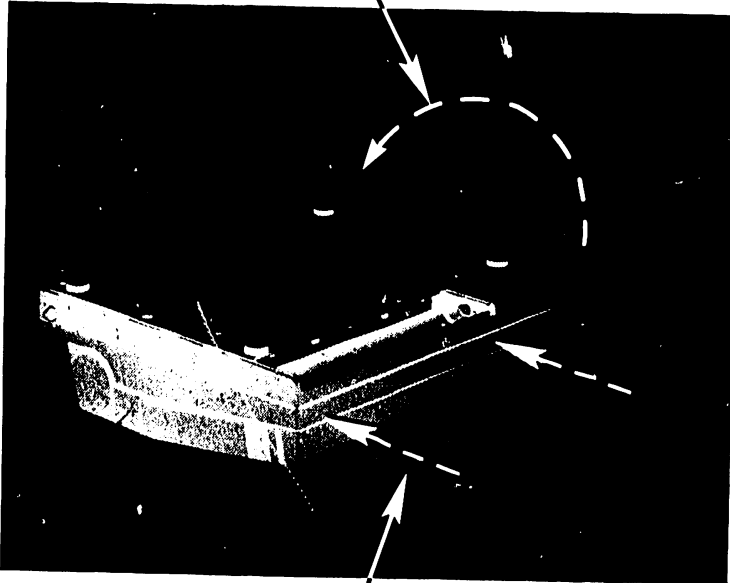

- 2 Fit BATTERY COVER to slide into place in LOWER CASE.

- 3 Snap BATTERY COVER closed by gentle pressure near textured pressure points on BATTERY COVER.

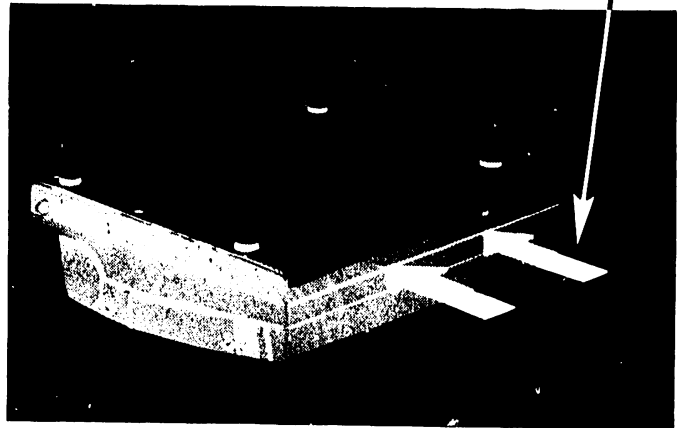

7.4

Reinstallation Procedures

REPAIR

7.4.6

NICAD BATT Assembly (sheet 1 of 2)

CAUTION

Always wear a properly grounded wrist strap whenever any part of WLTC case is open.

The NIACD BATT ASSY fits into LOWER CASE and is enclosed and protected by BATTERY COVER. A 2-wire cable connects to POWER PCB ASSY.

- 1 Turn unit over to access BATTERY COVER.

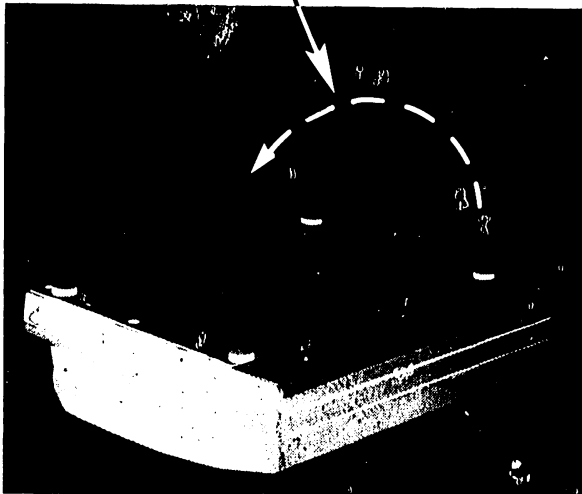

- 2 Remove BATTERY COVER (➡ 7.3.5).

- 3 Fit NICAD BATT ASSY into compartment leaving BATTERY CNN exposed.

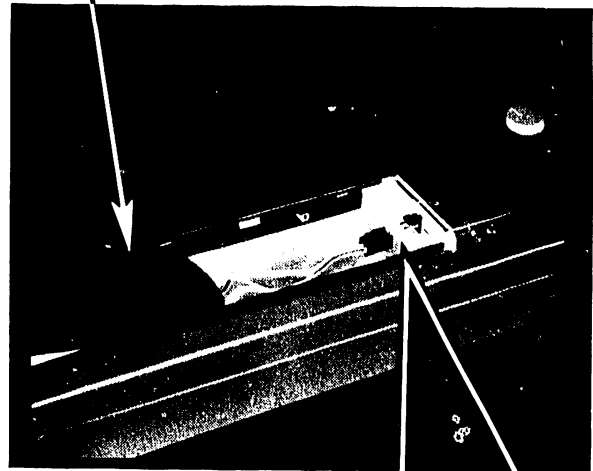

- 4 Connect and lock BATTERY CNN.

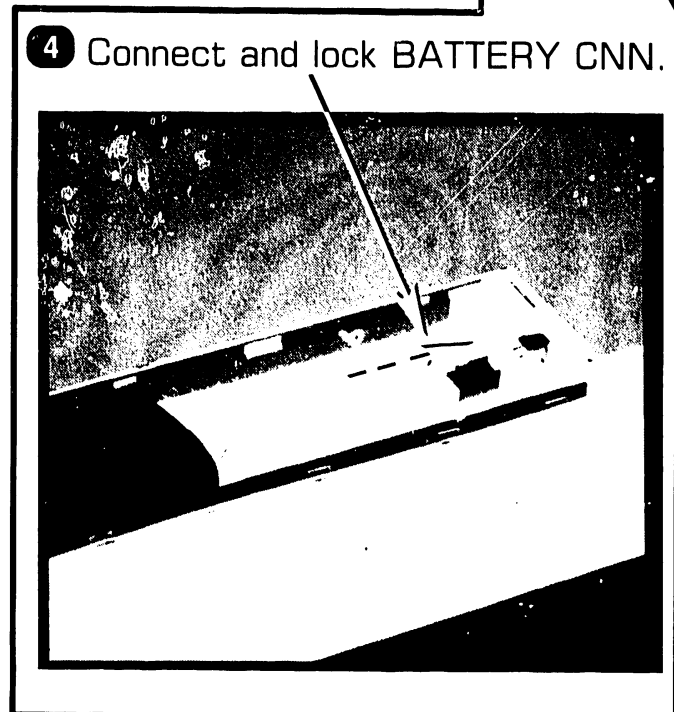

➡NEXT

7.4

Reinstallation Procedures

REPAIR

7.4.6

NICAD BATT Assembly (sheet 2 of 2)

CAUTION

Always wear a properly grounded wrist strap whenever any part of WLTC case is open.

- 6 Reinstall BATTERY COVER (➡ 7.4.5).

The NICAD BATT ASSY fits into LOWER CASE and is enclosed and protected by BATTERY COVER. A 2-wire cable connects to POWER PCB ASSY.

- 5 Fully fit NICAD BATT ASSY into compartment.

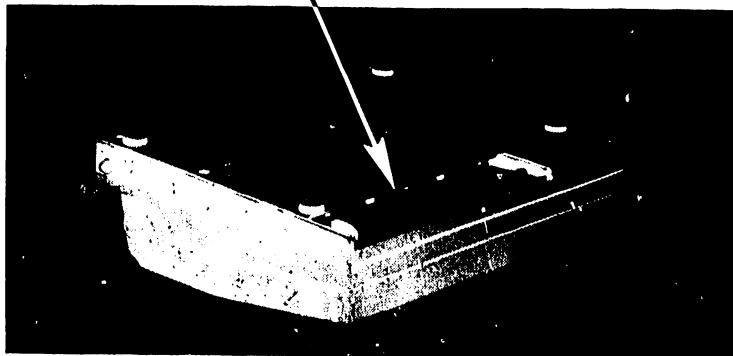

◆ END

7.4

Reinstallation Procedures

REPAIR

7.4.7

Arm Cap R

CAUTION

Always wear a properly grounded wrist strap whenever any part of WLTC case is open.

ARM CAP R snap fits into LCD ARM R and encloses and protects LCD FPC CABLE.

2 Snap ARM CAP R into place.

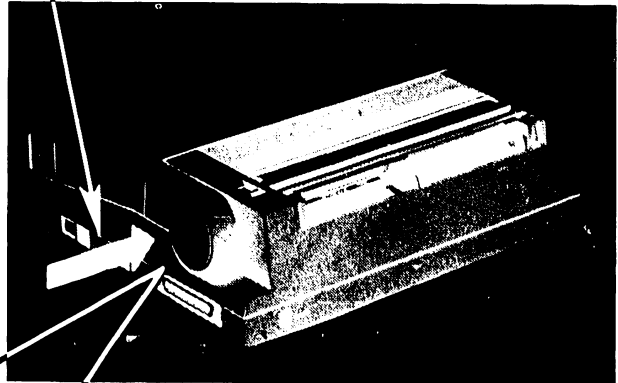

1 Align tabs on ARM CAP R with mating slots in LCD ARM R.

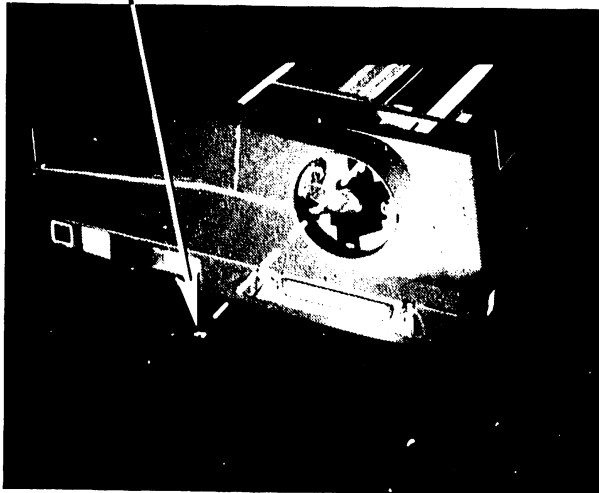

7.4

Reinstallation Procedures

REPAIR

7.4.8 Platen Knob Assembly

CAUTION

Always wear a properly grounded wrist strap whenever any part of WLTC case is open.

PLATEN KNOB ASSY friction-fits into LCD ARM L and may be used to turn PLATEN.

- 1 Align slot on PLATEN KNOB ASSY to fit LCD ARM L.

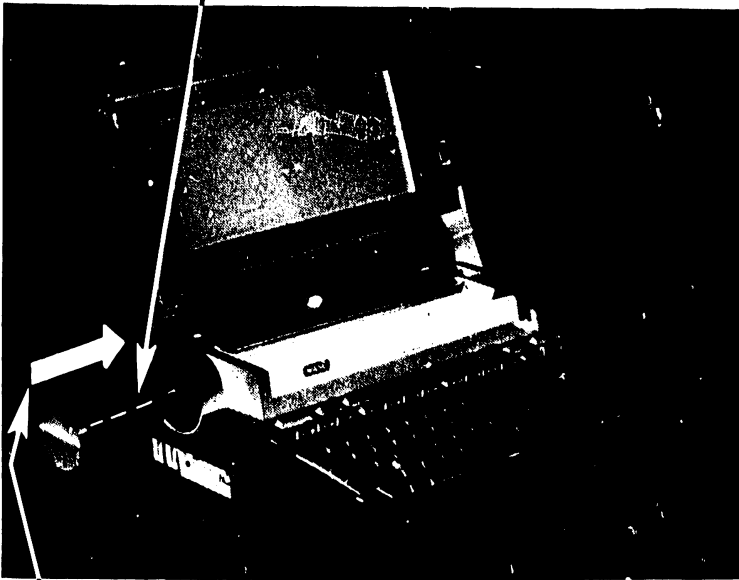

- 2 Push PLATEN KNOB ASSY straight into LCD ARM L.

7.4

Reinstallation Procedures

REPAIR

7.4.9

Cassette Cover Assembly

CAUTION

Always wear a properly grounded wrist strap whenever any part of WLTC case is open.

The CASSETTE COVER ASSY snap fits into UPPER CASE. It partially encloses and protects PRINTER ASSY. It may be raised for access to PRINTER ASSY and CASSETTE ASSY.

- 1 Fit right (or left) trunnion on CASSETTE COVER ASSY into its seat in UPPER CASE.

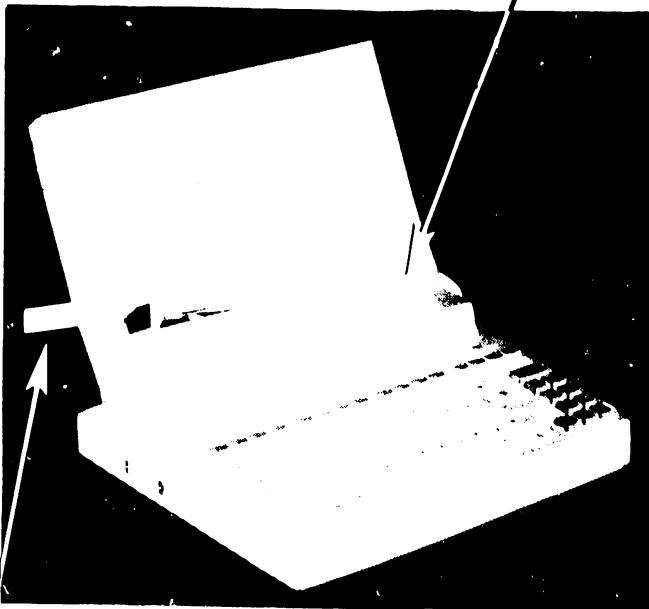

- 2 Gently push against left side (or right) of CASSETTE COVER ASSY to engage second trunnion in its seat.

- 3 Close CASSETTE COVER ASSY by gentle pressure near textured pressure points on CASSETTE COVER ASSY.

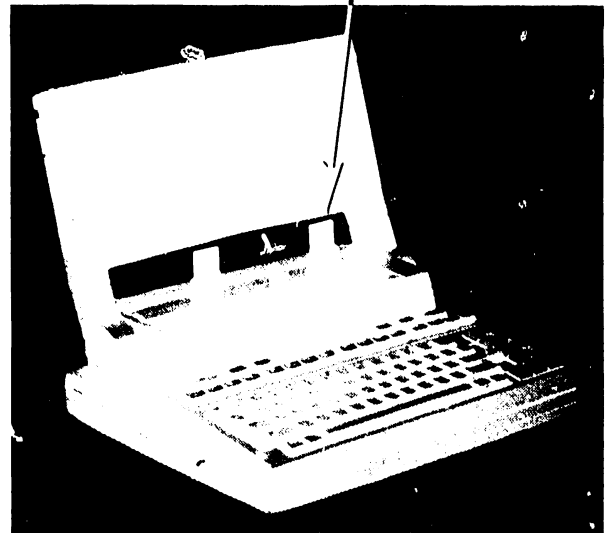

7.4.10 Reconnecting Upper and Lower Case (sheet 1 of 2)

CAUTION

Always wear a properly grounded wrist strap whenever any part of WLTC case is open.

The UPPER CASE is secured to the LOWER by five captive screws and washers, and two screws and washers under the NICAD BATT ASSY. Five cables connect the two halves of the case.

- 1 Rest UPPER CASE on its side next to LOWER CASE.

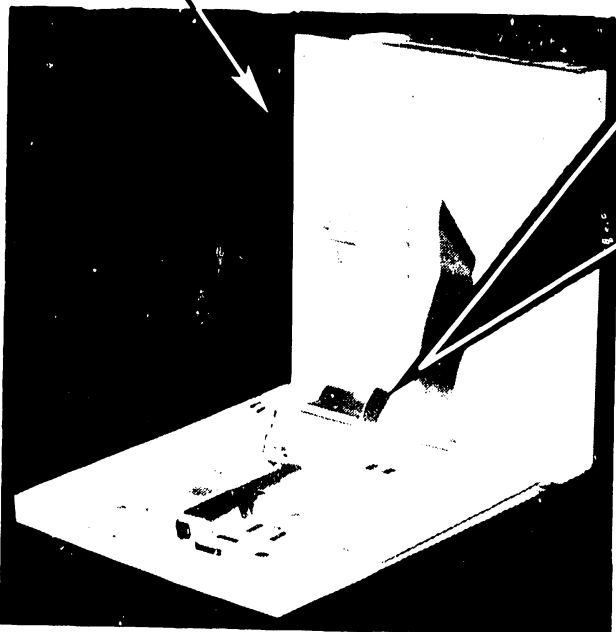

- 2 Plug ARM FPC CABLE into its connector and lock it (▶ 7.2.1).

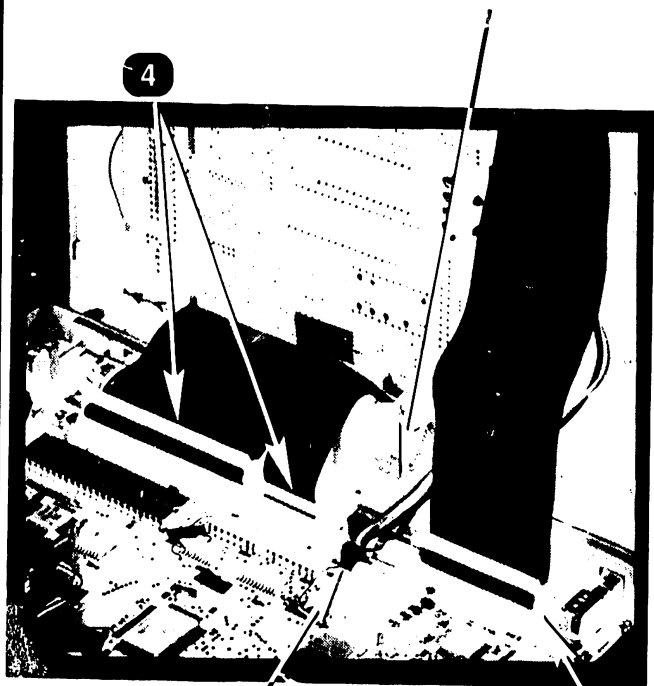

- 3 Connect 4-pin HDD CABLE (▶ 7.2.3).

- 4 Connect three ribbon cables:
 - a. SCSI CABLE
 - b. PRINTER CABLE
 - c. K/B CABLE

▶ NEXT

7.4

Reinstallation Procedures

REPAIR

7.4.10

Reconnecting Upper and Lower Case (sheet 2 of 2)

CAUTION

Always wear a properly grounded wrist strap whenever any part of WLTC case is open.

- 5 Swing UPPER CASE down to mate with LOWER CASE: Ensure correct fit.

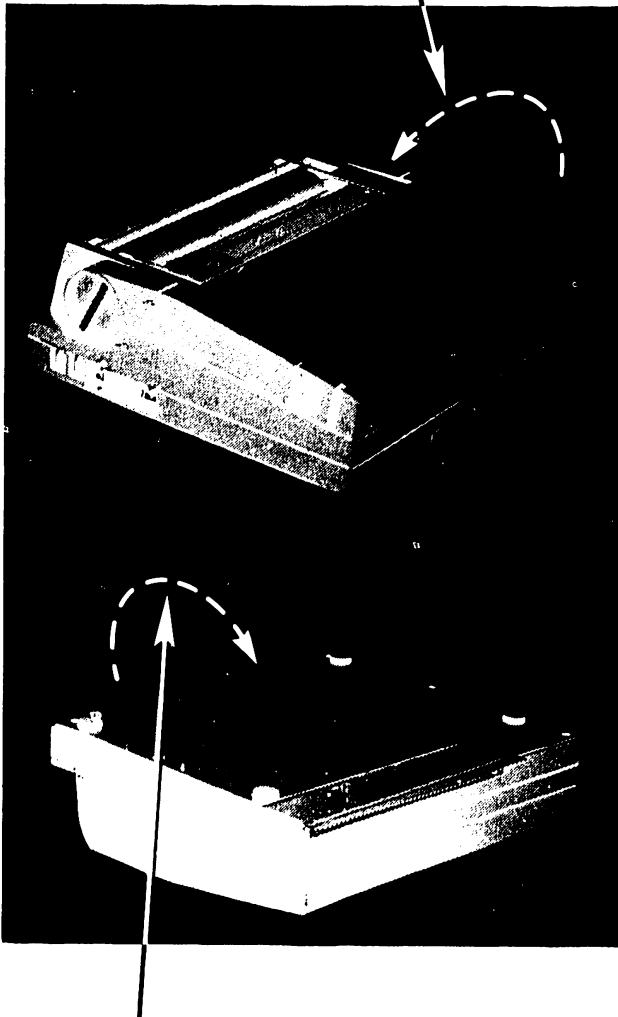

- 6 Turn unit over to access securing screws.

- 7 Install all five captive screws and two screws in battery compartment: Tighten

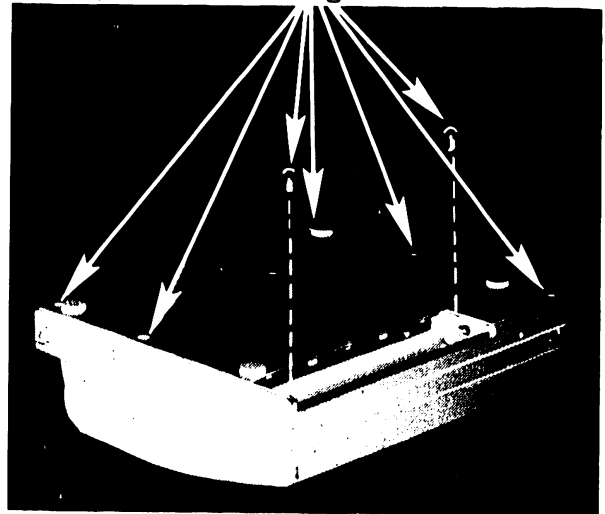

- 8 Connect NICAD BATT ASSY (➡ 7.4.6).
- 9 Install BATTERY COVER (➡ 7.4.5).

◆END

7.4

Reinstallation Procedures

REPAIR

7.4.11 Earth SP (sheet 1 of 2)

CAUTION

Always wear a properly grounded wrist strap whenever any part of WLTC case is open.

Four "earth springs" (EARTH SP) provide positive contact between FCC plates. The two in LOWER CASE are secured by MAIN PCB ASSY mounting screws. Earth springs in UPPER CASE are secured by mounting screws for HDD and FPC HOLDER.

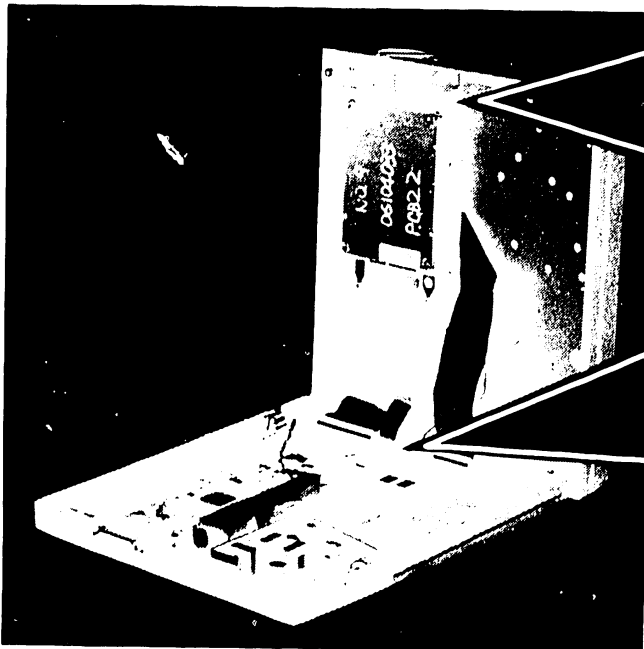

- 1 Fit each EARTH SP to its respective location.

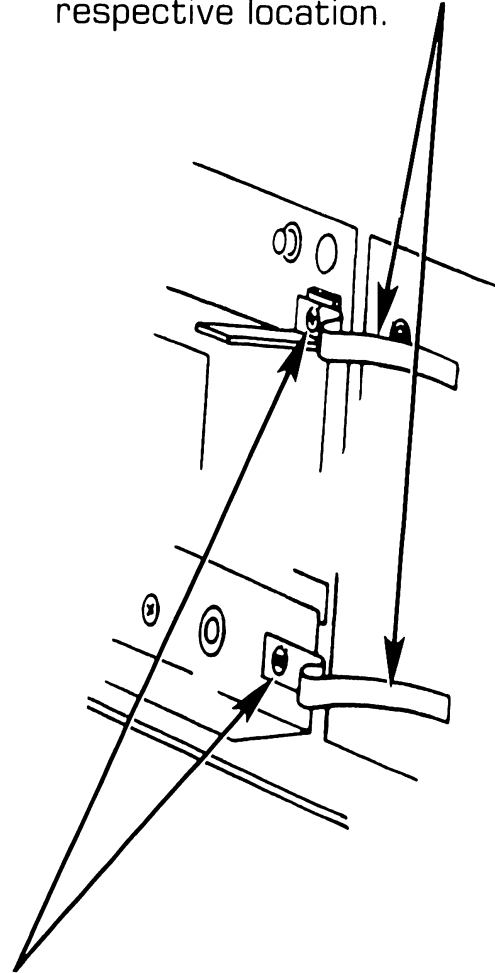

- 2 Install mounting screws: Tighten.

Upper Case

► NEXT

7.4

Reinstallation Procedures

REPAIR

7.4.11 Earth SP (sheet 2 of 2)

CAUTION

Always wear a properly grounded wrist strap whenever any part of WLTC case is open.

Four "earth springs" (EARTH SP) provide positive contact between FCC plates. The two in LOWER CASE are secured by MAIN PCB ASSY mounting screws. Earth springs in UPPER CASE are secured by mounting screws for HDD and FPC HOLDER.



- 1 Fit each EARTH SP to its respective location.

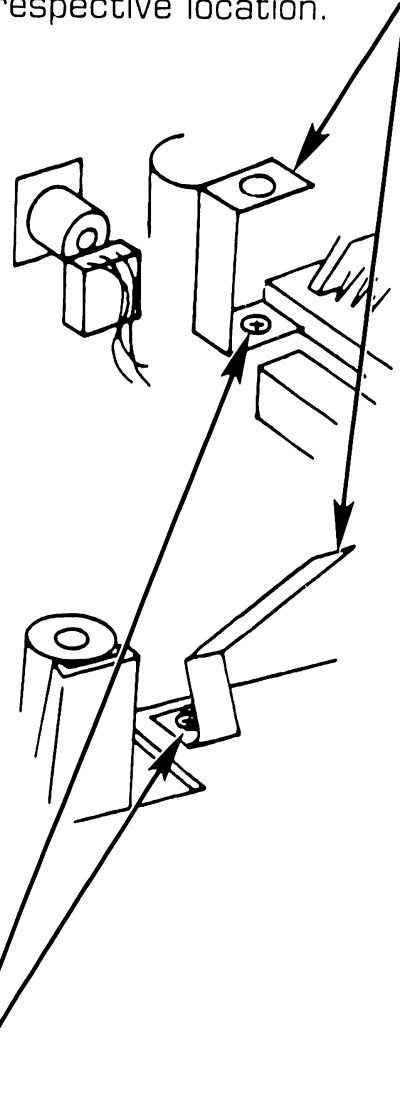

- 2 Install mounting screws: Tighten.

Lower Case

- 3 Reconnect UPPER and LOWER CASE (➡ 7.4.10).

◆END

7.4

Reinstallation Procedures

REPAIR

7.4.12

Reset Button

CAUTION

Always wear a properly grounded wrist strap whenever any part of WLTC case is open.

The RESET BUTTON is friction-fitted onto the actuating lever of the RESET SWITCH and may be removed without removing other parts of the WLTC or even opening the case.

CAUTION

Ensure correct orientation of RESET BUTTON: the mating slot for the actuating lever is offset on the RESET BUTTON. Improper installation may jam RESET SWITCH.

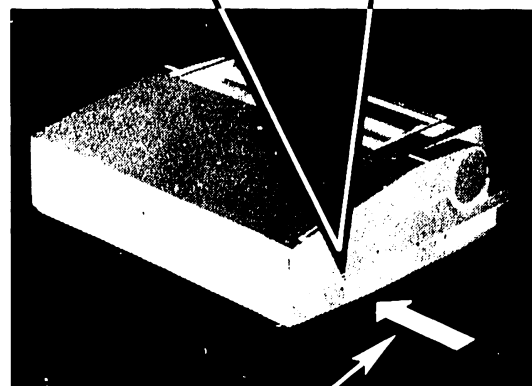
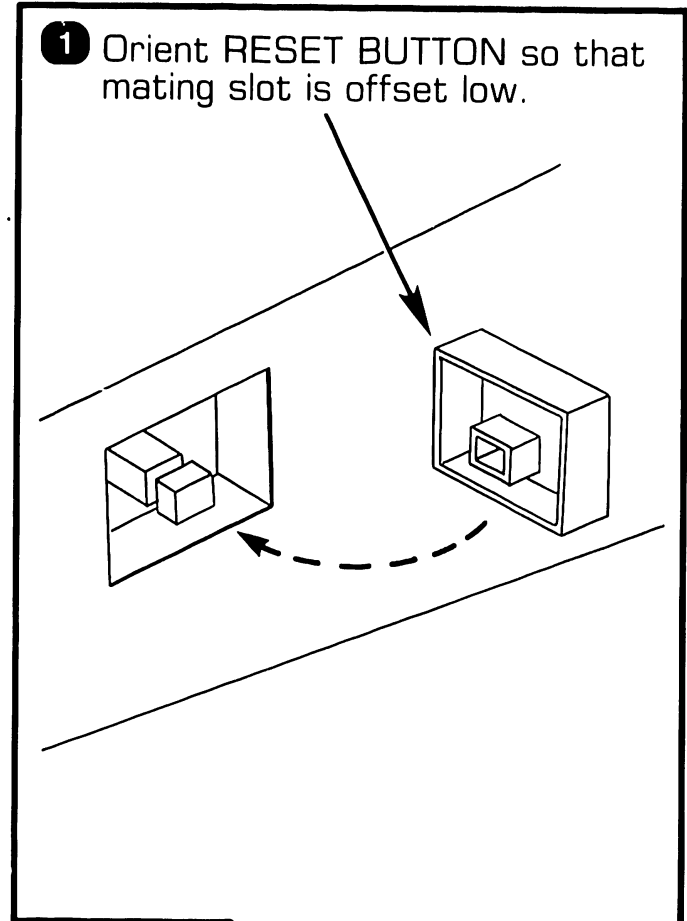

2 Carefully push RESET BUTTON onto actuating lever of RESET SWITCH.

7.4

Reinstallation Procedures

REPAIR

7.4.13 STD RAM PCB

CAUTION

Always wear a properly grounded wrist strap whenever any part of WLTC case is open.

The STD RAM PCB is supported on one edge by its connection with MAIN PCB, the opposite edge is supported by a lip on SUB BATT ASSY. Two screws secure the connector.

- 3 Install two screws in connector: Tighten.

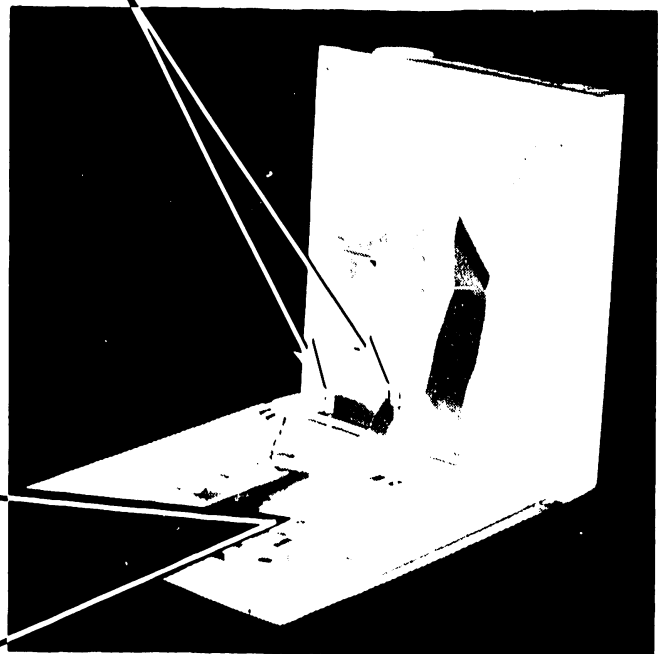

- 1 Fit edge opposite connector of STD RAM PCB between shelves on SUB BATT ASSY.

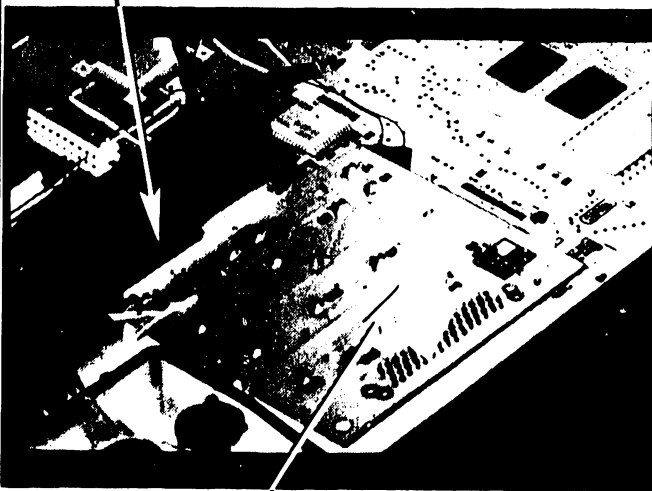

- 2 Gently push down on STD RAM PCB to plug into MAIN PCB ASSY.

- 4 Reconnect UPPER and LOWER CASE (➡ 7.4.10).

7.4

Reinstallation Procedures

REPAIR

7.4.14 Sub Batt Assembly (sheet 1 of 2)

CAUTION

Always wear a properly grounded wrist strap whenever any part of WLTC case is open.

The SUB BATT ASSY is fastened to MAIN PCB by one screw and a tab which fits into a notch in edge of MAIN PCB. Two cables connect to MAIN PCB.

NOTE

Reinstallation is easier if cables are connected before SUB BATT ASSY is fitted into place.

- 1 Dress 3-wire HARNESS ASSY from POWER PCB ASSY to run under SUB BATT ASSY.



- 2 Connect two cables to MAIN PCB ASSY.
 - a. BATT CABLE
 - b. SPEAKER CABLE

7.4

Reinstallation Procedures

REPAIR

7.4.14 Sub Batt Assembly (sheet 2 of 2)

CAUTION

Always wear a properly grounded wrist strap whenever any part of WLTC case is open.

NOTE

Tab on SUB BATT ASSY sometimes catches on FCC PLATE after being fitted over edge of MAIN PCB ASSY. To avoid this, gently lift SUB BATT ASSY while locking in place.

- 4 Install single screw and tighten.

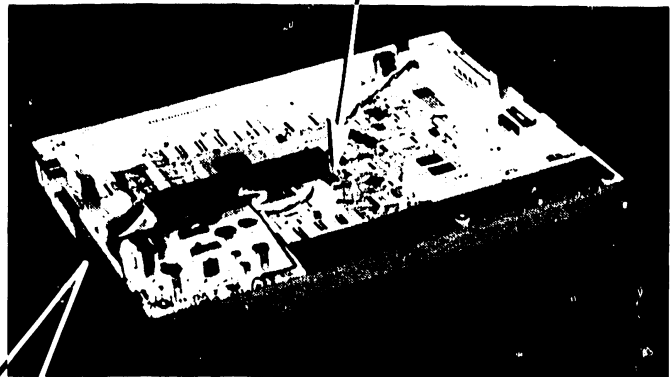

- 3 Fit tab on SUB BATT ASSY over edge of MAIN PCB ASSY: lock in place by pushing SUB BATT ASSY away from edge of LOWER CASE.

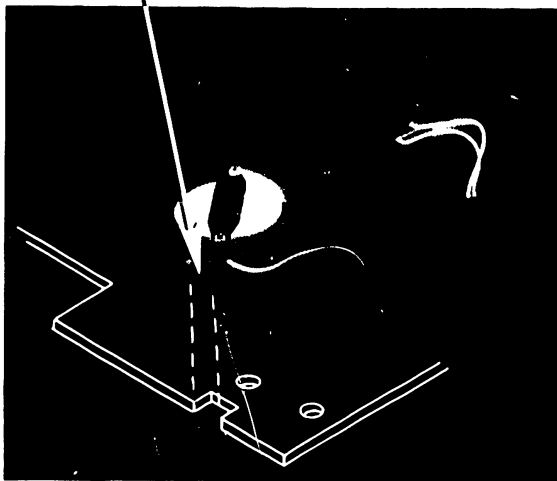

- 5 Reinstall STD RAM PCB (▶ 7.4.13).
- 6 Reconnect UPPER and LOWER CASE (▶ 7.4.10).

●END

7.4

Reinstallation Procedures

REPAIR

7.4.15 Power PCB Assembly

CAUTION

Always wear a properly grounded wrist strap whenever any part of WLTC case is open.

The POWER PCB ASSY is fastened to LOWER CASE by two screws. A 12-wire HARNESS ASSY and a 3-wire HARNESS ASSY connect to MAIN PCB. The NICAD BATT ASSY plugs into the POWER PCB ASSY.

- 2 Install two mounting screws.

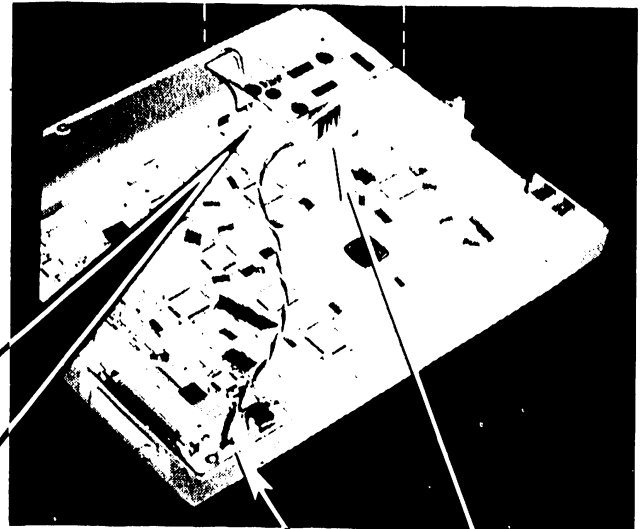

- 1 Taking care to clear NICAD BATT connector, fit POWER PCB ASSY in place over guide pin.

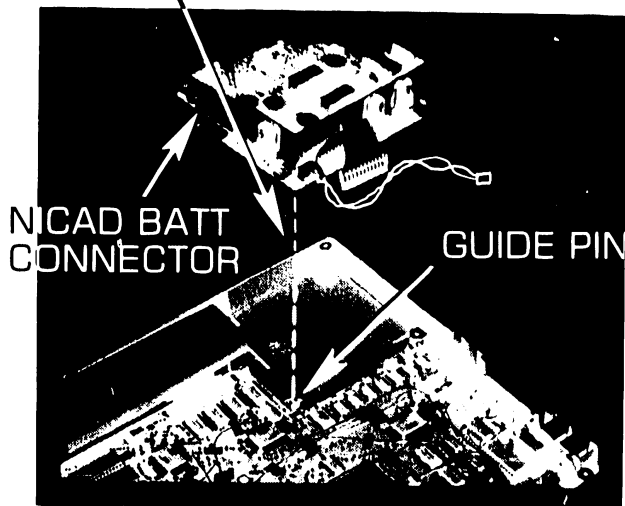

- 3 Dress 3-wire HARNESS ASSY to run under SUB BATT ASSY. Connect to MAIN PCB ASSY.
- 4 Connect 12-wire HARNESS ASSY to MAIN PCB ASSY.
- 5 Reconnect UPPER and LOWER CASE (▶ 7.4.10).
- 6 Connect NICAD BATT ASSY (▶ 7.4.6).

7.4

Reinstallation Procedures

REPAIR

7.4.16 Main PCB (sheet 1 of 2)

CAUTION

Always wear a properly grounded wrist strap whenever any part of WLTC case is open.

The MAIN PCB is fastened to LOWER CASE by ten screws. Two cables connect to POWER PCB ASSY. Cables also connect to:

- HDD ASSY
- HDD PCB (SCSI)
- K/B FULL ASSY
- LCD ASSY, and
- PRINTER ASSY
- SCSI CONNECTOR
- SUB BATT ASSY

The STD RAM PCB and SUB BATT ASSY mount on MAIN PCB.

- 2 Fit SCSI CONNECTOR into side of LOWER CASE and position MAIN PCB ASSY onto FCC PLATE.

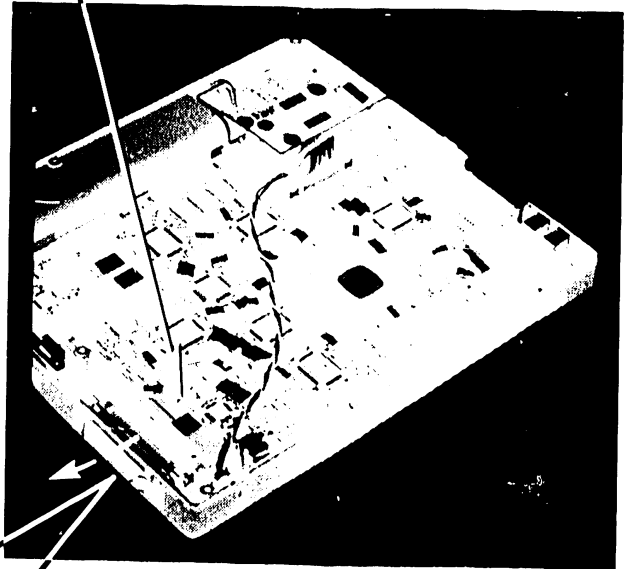

- 1 Fold inward the wire "ears" on SCSI CONNECTOR.

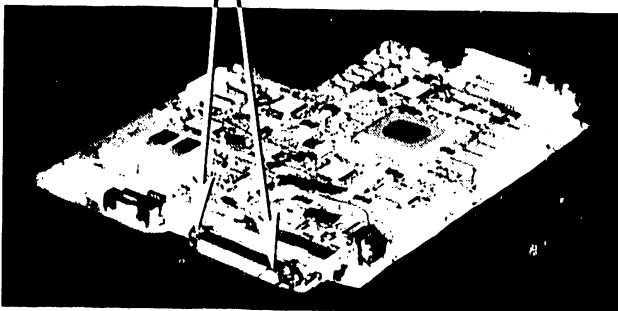

◆NEXT

7.4

Reinstallation Procedures

REPAIR

7.4.16 Main PCB (sheet 2 of 2)

CAUTION

Always wear a properly grounded wrist strap whenever any part of WLTC case is open.

- 3 Install EARTH SP PH, EARTH SP HDD ASSY, and their mounting screws (➡ 7.4.11).

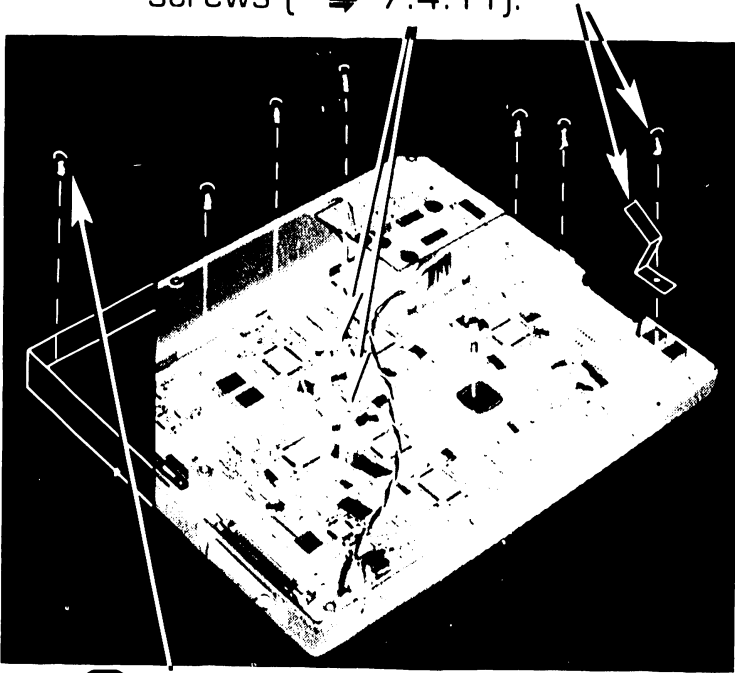

- 4 Install remaining seven mounting screws. Tighten all screws.

- 5 Connect 12-wire HARNESS ASSY and 3-wire HARNESS ASSY from POWER PCB ASSY.

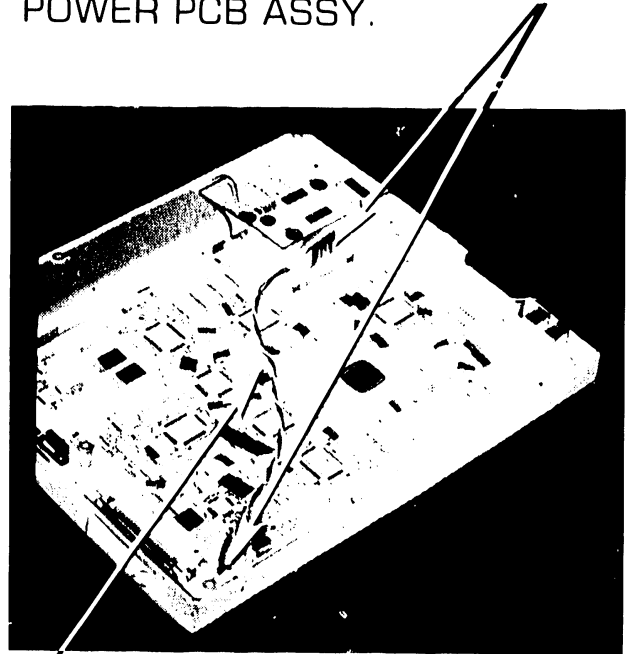

- 6 Dress 3-wire HARNESS ASSY under SUB BATT ASSY.

- 7 Reinstall SUB BATT ASSY (➡ 7.4.14).

- 8 Reinstall STD RAM PCB (➡ 7.4.13).

- 9 Reconnect UPPER AND LOWER CASE (➡ 7.4.10).

◆END

7.4

Reinstallation Procedures

REPAIR

7.4.17

Lower Case

CAUTION

Always wear a properly grounded wrist strap whenever any part of WLTC case is open.

The LOWER CASE is only the molded plastic unit. All other items are separate.

- 1 Fit FCC PLATE into LOWER CASE.

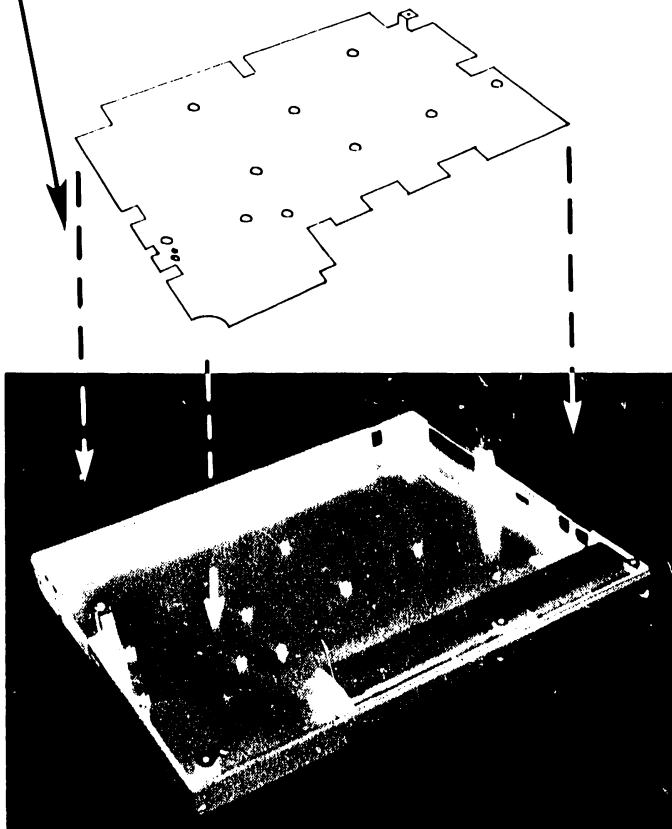

- 2 Reinstall MAIN PCB ASSY (➤ 7.4.16).

- 3 Reinstall POWER PCB ASSY (➤ 7.4.15).

- 4 Reinstall SUB BATT ASSY (➤ 7.4.14).

- 5 Reinstall STD RAM PCB (➤ 7.4.13).

- 6 Reinstall EARTH SP (➤ 7.4.11).

- 7 Reconnect UPPER and LOWER CASE (➤ 7.4.10).

7.4

Reinstallation Procedures

REPAIR

7.4.18 HDD PCB (SCSI) (sheet 1 of 2)

CAUTION

Always wear a properly grounded wrist strap whenever any part of WLTC case is open.

The HDD PCB (SCSI) is fastened to flanges on HDD ASSY by two screws and to a standoff on PRINTER ASSY FRAME by one screw. Cable connections are:

- HDD CABLE 26 connects to HDD ASSY.
- HDD CABLE 50 connects to MAIN PCB ASSY.
- HDD POWER CABLE 4-PIN connects to MAIN PCB ASSY.

CAUTION

Reinstallation of HDD PCB (SCSI) is easier if HDD CABLE 26, HDD CABLE 50, and HDD POWER CABLE 4-PIN are first disconnected from HDD ASSY and MAIN PCB ASSY, respectively.

- 1 Connect HDD CABLE 26 to HDD PCB (SCSI).



- 2 Connect HDD CABLE 50 to HDD PCB (SCSI).

- 3 Connect HDD POWER CABLE 4-PIN to HDD PCB (SCSI).

▶NEXT

7.4

Reinstallation Procedures

REPAIR

7.4.18 HDD PCB (SCSI) (sheet 2 of 2)

CAUTION

Always wear a properly grounded wrist strap whenever any part of WLTC case is open.

- 4 Fit HDD PCB (SCSI) to flanges on HDD ASSY and standoff on PRINTER ASSY FRAME.

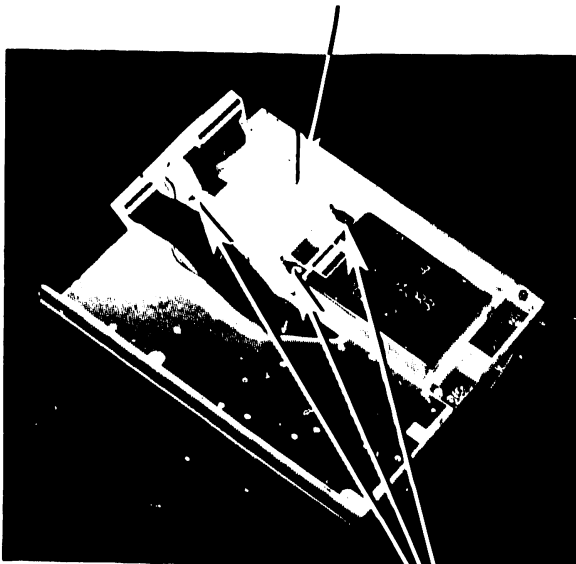

- 5 Install mounting screws on each flange and standoff. Tighten all screws.

- 6 Connect HDD CABLE 26 to HDD ASSY.

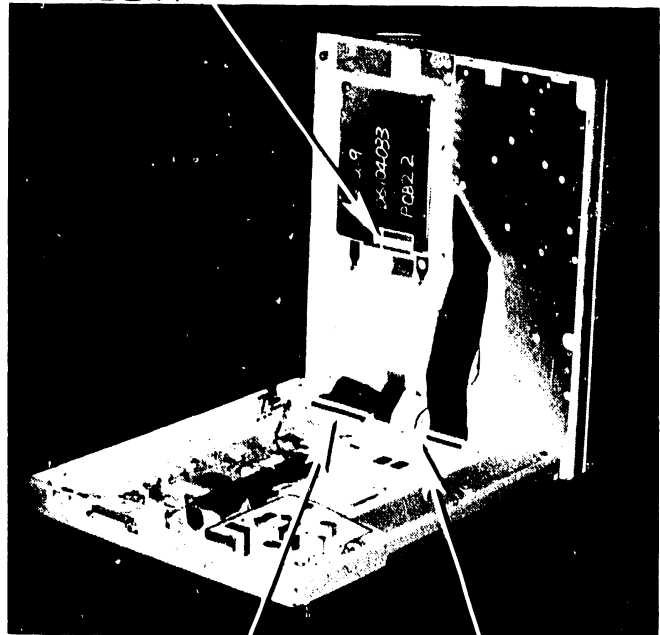

- 7 Connect HDD CABLE 50 to HDD ASSY.
- 8 Connect HDD POWER CABLE 4-PIN to MAIN PCB ASSY.
- 9 Reconnect UPPER and LOWER CASE (▶ 7.4.10).

◆END

7.4.19 HDD Cable 26

CAUTION

Always wear a properly grounded wrist strap whenever any part of WLTC case is open.

HDD CABLE 26 plugs into component side of HDD PCB (SCSI) and connects to HDD ASSY.

Notice that, to install HDD CABLE 26, it is necessary to remove HDD PCB (SCSI), but not to separate completely the UPPER CASE from LOWER.

- 1 Carefully plug HDD CABLE 26 into HDD PCB (SCSI).

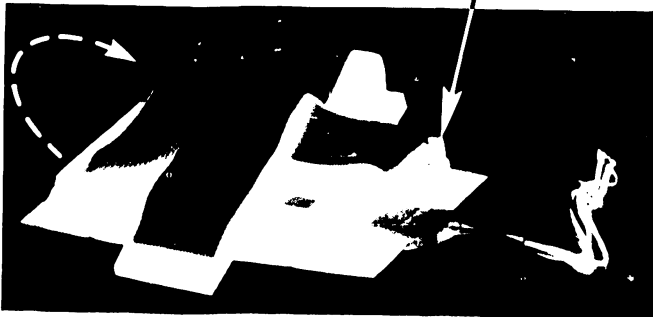

- 2 Reinstall HDD PCB (SCSI) (➡ 7.4.18).

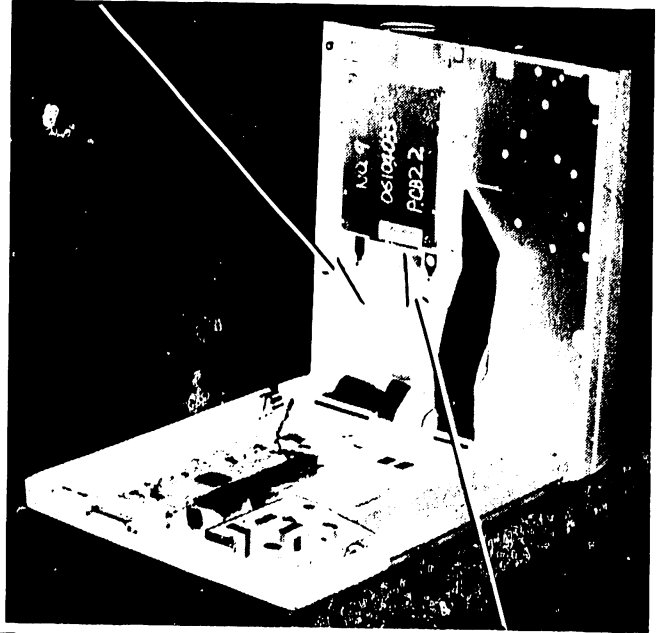

- 3 Plug HDD CABLE 26 into HDD ASSY.
- 4 Reconnect UPPER and LOWER CASE (➡ 7.4.10).

7.4.20 HDD Cable 50

CAUTION

Always wear a properly grounded wrist strap whenever any part of WLTC case is open.

HDD CABLE 50 plugs into component side of HDD PCB (SCSI) and connects to MAIN PCB ASSY.

Notice that, to install HDD CABLE 50, it is necessary to remove HDD PCB (SCSI), but not to separate completely the UPPER CASE from LOWER.

- 1 Carefully plug HDD CABLE 50 into HDD PCB (SCSI).



- 2 Reinstall HDD PCB (SCSI) (➤ 7.4.18).

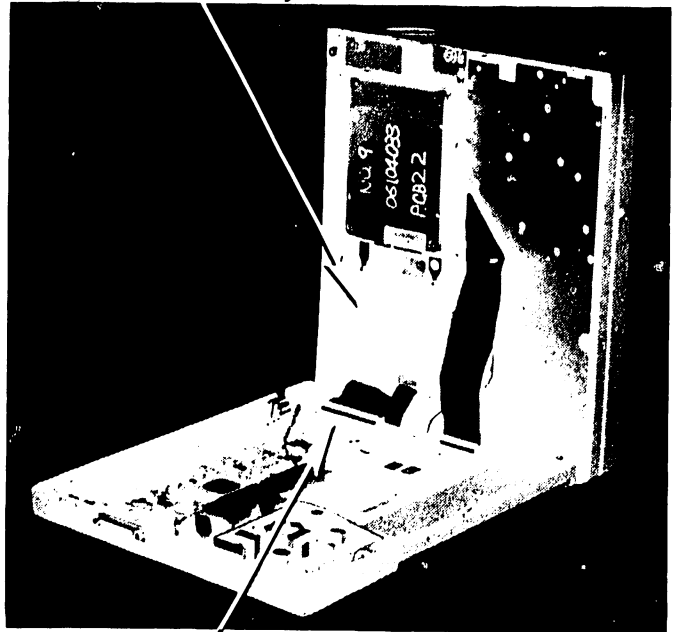

- 3 Plug HDD CABLE 50 into MAIN PCB.
- 4 Reconnect UPPER and LOWER CASE (➤ 7.4.10).

7.4.21 HDD Power Cable 4-Pin

CAUTION

Always wear a properly grounded wrist strap whenever any part of WLTC case is open.

HDD POWER CABLE 4-PIN plugs into component side of HDD PCB (SCSI) and connects to MAIN PCB ASSY.

Notice that, it is not necessary to remove HDD PCB (SCSI), nor completely separate UPPER CASE from LOWER, to install HDD POWER CABLE 4-PIN.



- 1 Connect HDD POWER CABLE 4-PIN at HDD PCB (SCSI).

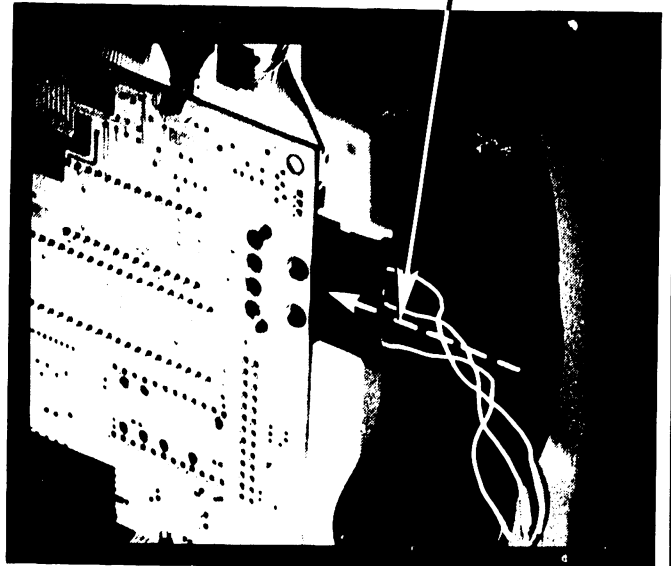

- 2 Connect HDD POWER CABLE 4-PIN at MAIN PCB ASSY.

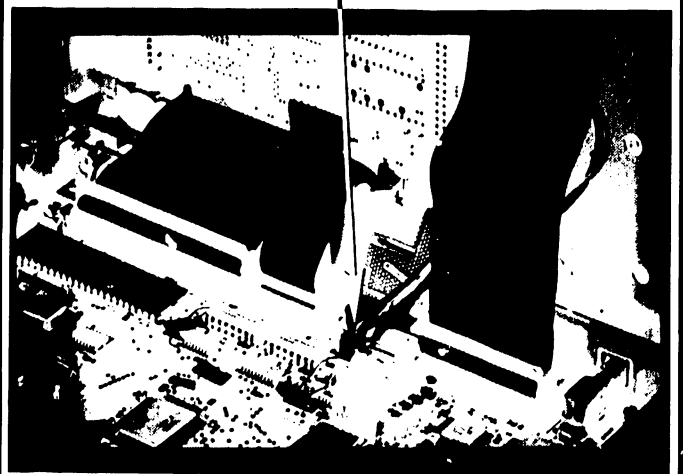

- 3 Reconnect UPPER and LOWER CASE (➤ 7.4.10).

7.4.22

Printer PCB Assembly (sheet 1 of 3)

CAUTION

Always wear a properly grounded wrist strap whenever any part of WLTC case is open.

The PRINTER PCB ASSY is positioned on PRINTER ASSY FRAME by three, notched, standoff tabs and fastened in place by one screw. One ribbon cable connects to MAIN PCB; five cable assemblies and one FPC cable connect to PRINTER ASSY:

Ribbon cable to MAIN PCB (P1)
Power cable (P2)
PAPER END sensor cable (P3)
LF-MOTOR cable (P4)
DR-MOTOR cable (P5)
HD-MOTOR cable (P6)
FPC CABLE to PRINTER ASSY (P7)

- 1 Ensure PRINTER PCB ASSY matches PRINT HEAD (➡ 7.2.5).

- 2 Fit PRINTER PCB ASSY into standoffs on PRINTER ASSY and slide toward front of UPPER CASE to engage notches.

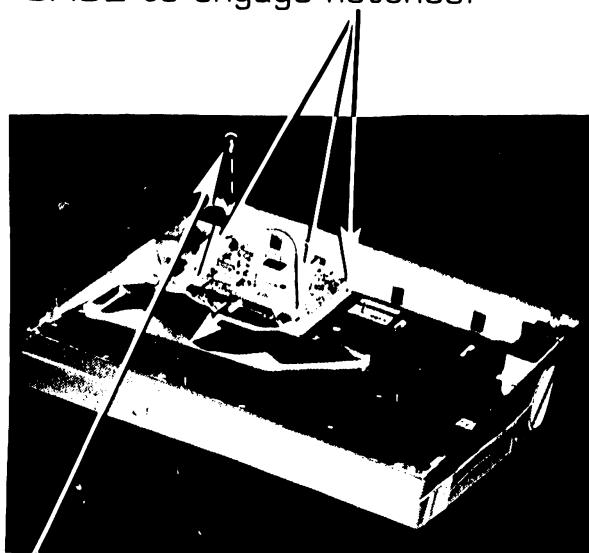

- 3 Install screw and tighten.

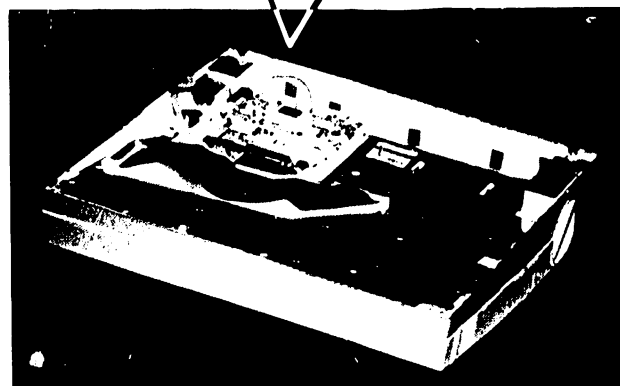

➡ NEXT

7.4.22

Printer PCB Assembly (sheet 2 of 3)

CAUTION

Always wear a properly grounded wrist strap whenever any part of WLTC case is open.

CAUTION

Match colors on cable connectors. Some connectors are interchangeable, and this color coding is the **only** way to correctly connect cables.

- 4 Connect five mini-connector cables from PRINTER ASSY:
 - a. LF-MOTOR cable (P4)
 - b. PAPER END SENSOR cable (P3)
 - c. Power cable (P2)
 - d. HD-MOTOR cable (P6)
 - e. DR-MOTOR cable (P5)

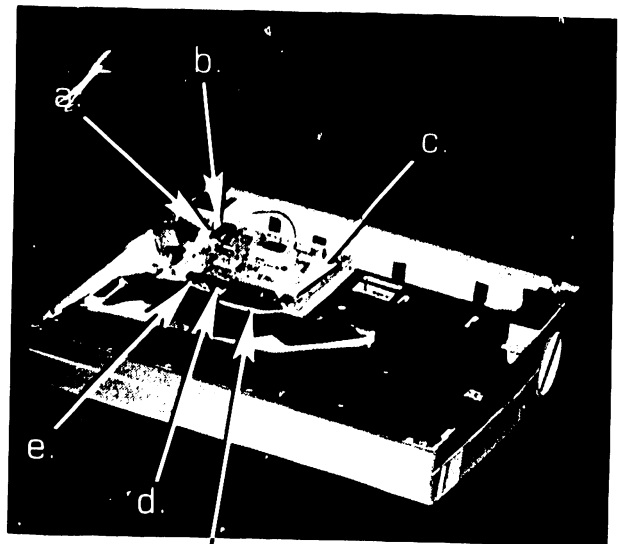
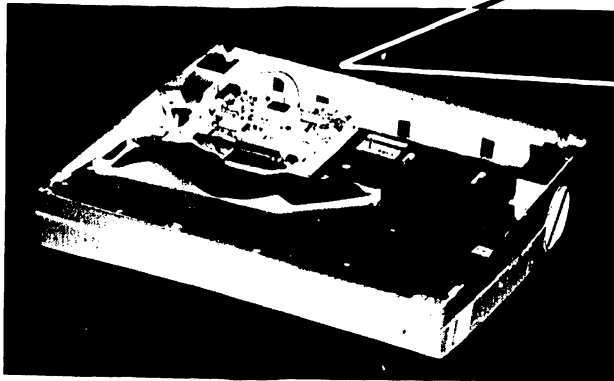

- 5 Connect and lock FPC CABLE (P7) from PRINTER ASSY.

► NEXT

7.4.22

Printer PCB Assembly (sheet 3 of 3)

CAUTION

Always wear a properly grounded wrist strap whenever any part of WLTC case is open.

- 6 Reinstall HDD PCB (SCSI)
(➤ 7.4.18).
- 7 Reconnect UPPER and LOWER
CASE (➤ 7.4.10).

● END

7.4.23

HDD Assembly

CAUTION

Always wear a properly grounded wrist strap whenever any part of WLTC case is open.

The HDD ASSY is fastened to PRINTER ASSY FRAME by four screws. One ribbon cable connects to HDD PCB (SCSI).

Notice that HDD ASSY may be installed without first having removed PRINTER PCB ASSY. Notice also that HDD ASSY and HDD PCB ASSY may be installed as a unit. The procedure described here assumes all other components are in place. Other installation sequences are obvious.

- 1 Align HDD ASSY on PRINTER ASSY FRAME.

- 2 Install three screws:
Do not tighten.

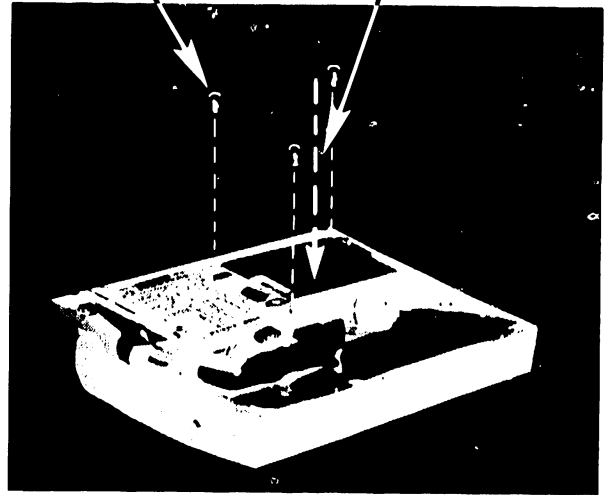

- 3 Install EARTH SP and screw:
Tighten all four screws.

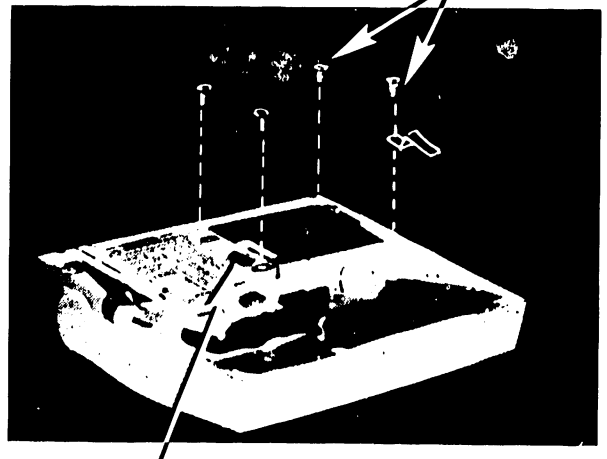

- 4 Connect HDD CABLE 26 from HDD PCB (SCSI).

- 5 Reconnect UPPER and LOWER CASE (▶ 7.4.10).

7.4.24 Printer Assembly (sheet 1 of 3)

CAUTION

Always wear a properly grounded wrist strap whenever any part of WLTC case is open.

The PRINTER ASSY is fastened to UPPER CASE by three shoulder screws and two screws securing FPC HOLDER. Five cable assemblies and one FPC cable connect to PRINTER PCB ASSY.

- 1 Ensure PRINTER PCB ASSY matches PRINT HEAD (➡ 7.2.5).
- 2 Carefully fit PLATEN SHAFT into mounting hole for PLATEN KNOB by tilting PRINTER ASSY into UPPER CASE.

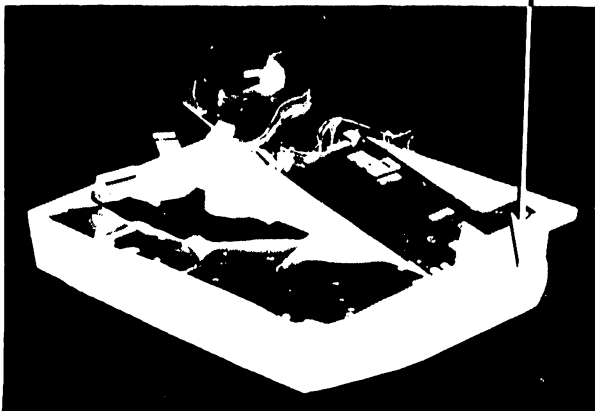

- 3 Lower PRINTER ASSY into UPPER CASE and align holes for mounting screws.

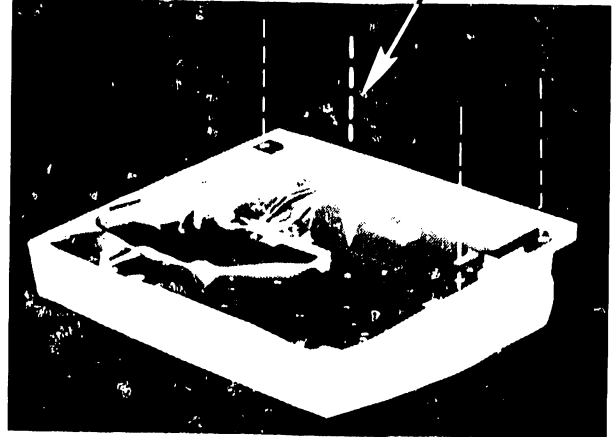

➡ NEXT

7.4.24

Printer Assembly (sheet 2 of 3)

CAUTION

Always wear a properly grounded wrist strap whenever any part of WLTC case is open.

CAUTION

Fit SHOULDER SCREWS and washers into correct holes (as shown): UPPER and LOWER CASEs will not close if screws are placed incorrectly.

- 4 Dress FPC alongside PRINTER ASSY and position FPC HOLDER.

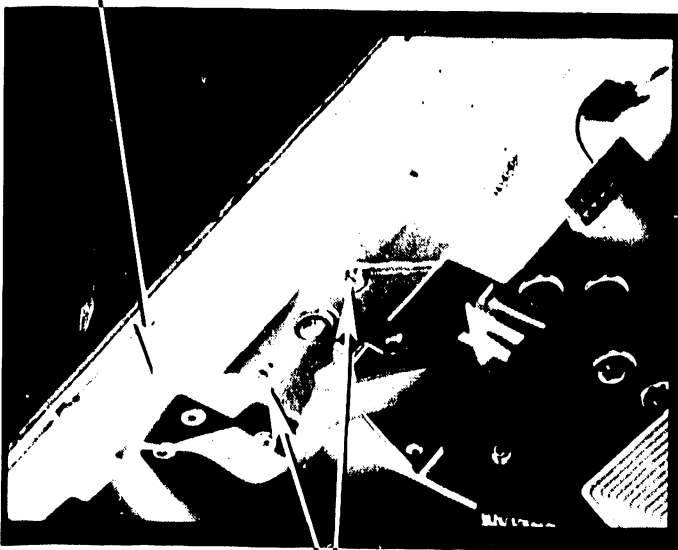

- 5 Install mounting screws (2) in FPC HOLDER, but *do not tighten*.

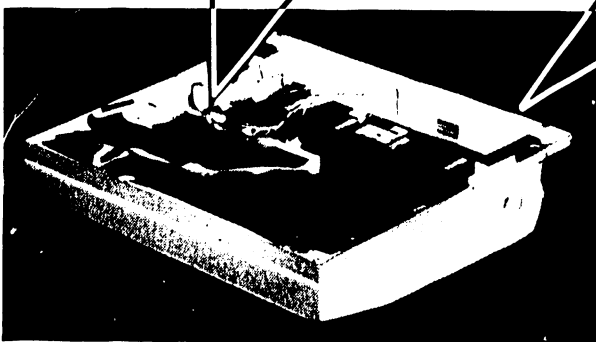

- 6 Install SHOULDER SCREW and washer at side of PRINTER ASSY. *Do not tighten*.

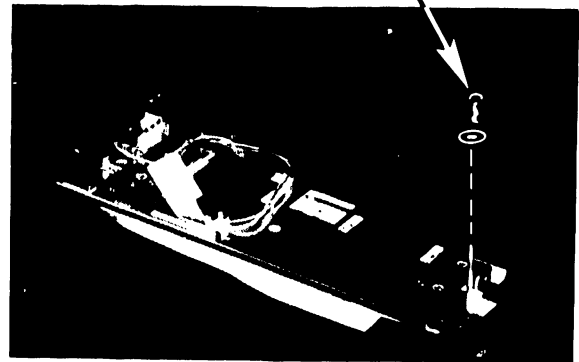

▶ NEXT

7.4.24

Printer Assembly (sheet 3 of 3)

CAUTION

Always wear a properly grounded wrist strap whenever any part of WLTC case is open.

- 7** Install remaining two SHOULDER SCREWS and washers.
Do not tighten.

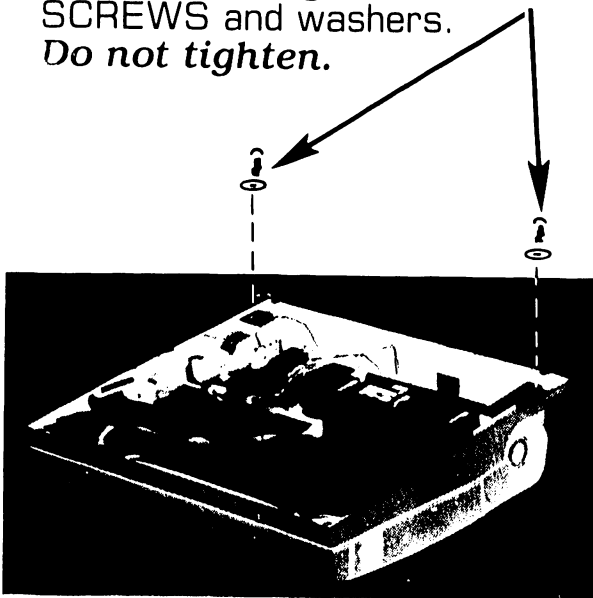

- 8** Tighten *all five* mounting screws.

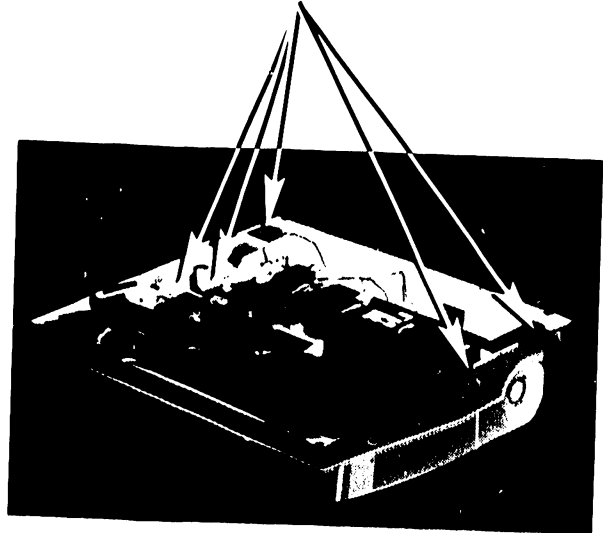

- 9** Reinstall HDD ASSY (▶ 7.4.23).
- 10** Reinstall PRINTER PCB ASSY (▶ 7.4.22).
- 11** Reinstall HDD PCB (SCSI) (▶ 7.4.18).
- 12** Reconnect UPPER CASE from LOWER (▶ 7.4.10).
- 13** Reinstall PLATEN KNOB ASSY (▶ 7.4.8).

●END

7.4.25 K/B Full Assembly

CAUTION

Always wear a properly grounded wrist strap whenever any part of WLTC case is open.

The K/B FULL ASSY consists of K/B ASSY and UPPER CASE.

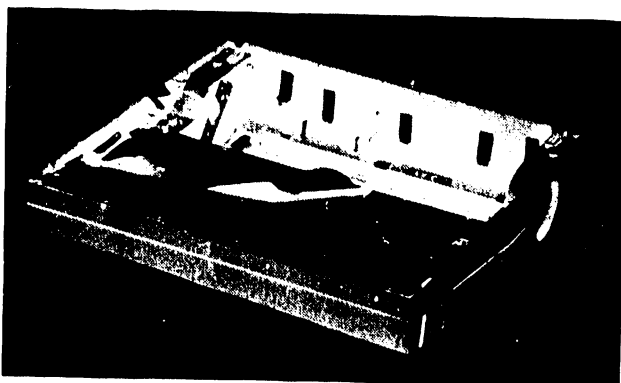

(UNDERSIDE)

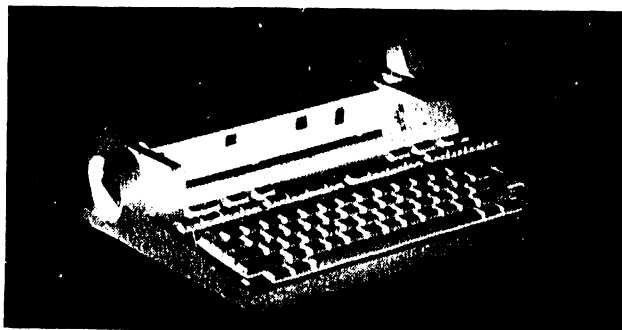

(UPPERSIDE)

NOTE

Steps 1, 2, 3, and 4 may be combined into a single step and the four assemblies reinstalled as a unit.

To do this, follow procedure for reinstalling PRINTER ASSY (➤ 7.4.24).

- 1 Reinstall PRINTER ASSY (➤ 7.4.24).
- 2 Reinstall HDD ASSY (➤ 7.4.23).
- 3 Reinstall PRINTER PCB ASSY (➤ 7.4.22).
- 4 Reinstall HDD PCB (SCSI) (➤ 7.4.18).
- 5 Reconnect UPPER CASE from LOWER (➤ 7.4.10).
- 6 Reinstall CASSETTE COVER ASSY (➤ 7.4.9).
- 7 Reinstall PLATEN KNOB ASSY (➤ 7.4.8).
- 8 Reinstall ARM CAP R (➤ 7.4.7).
- 9 Reinstall LCD ASSY (➤ 7.4.4).
- 10 Reinstall REAR COVER (➤ 7.4.1).

7.5

Removal Procedures, 3.5-Inch FDD

REPAIR

7.5.1 Access (sheet 1 of 2)

CAUTION

Always wear a properly grounded wrist strap whenever any part of WLTC case is open.

The 3.5-inch FDD subdivides naturally into four subunits: UPPER CASE (POWER SW ASSY attached), LOWER CASE, NICAD BATTERY, and FDD Assembly (POWER JACK ASSY attached).

- 1 Turn unit over to access screws securing LOWER CASE.

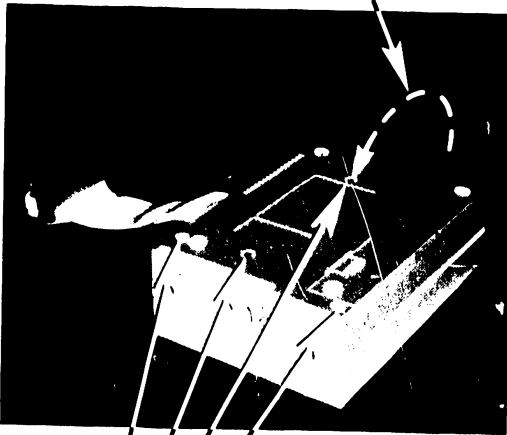

- 2 Remove four screws in LOWER CASE.

- 3 Lift rear, and unhook front, of LOWER CASE.

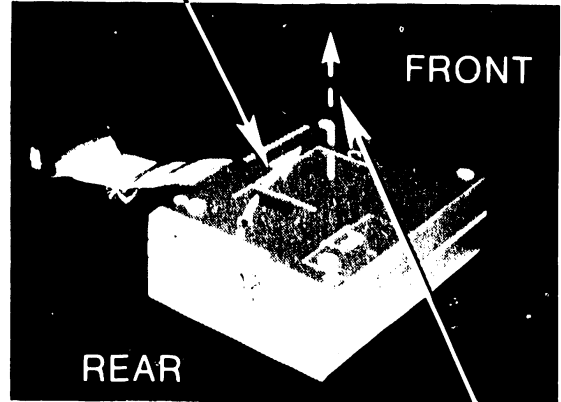

- 4 Lift LOWER CASE away from rest of unit.

➡ NEXT

7.5

Removal Procedures, 3.5-Inch FDD

REPAIR

7.5.1 Access (sheet 2 of 2)

CAUTION

Always wear a properly grounded wrist strap whenever any part of WLTC case is open.

- 5 Lift NICAD BATTERY out of UPPER CASE.

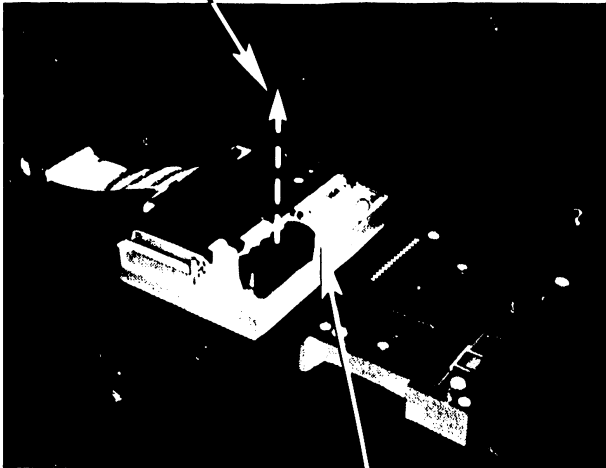

- 6 Disconnect BATTERY CONNECTOR.

CAUTION

Raise FDD Assembly slowly and carefully: POWER JACK ASSY will hang from two cables:

2-wire cable
ground wire.

- 7 Carefully lift FDD Assembly enough to clear UPPER CASE.

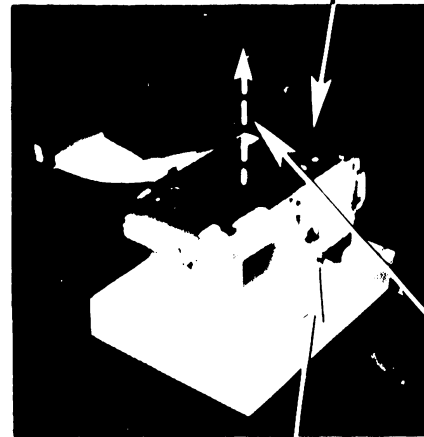

- 8 Disconnect 4-wire cable from POWER SW ASSY.
- 9 Lift FDD Assembly entirely clear of UPPER CASE.

◆ END

7.5

Removal Procedures, 3.5-Inch FDD

REPAIR

7.5.2

Battery Lid

CAUTION

Always wear a properly grounded wrist strap whenever any part of WLTC case is open.

The BATTERY LID encloses and protects NICAD BATTERY. It is snap fitted to LOWER CASE. BATTERY LID may be removed without access to interior of unit.

- 1 Turn unit over to access BATTERY LID.

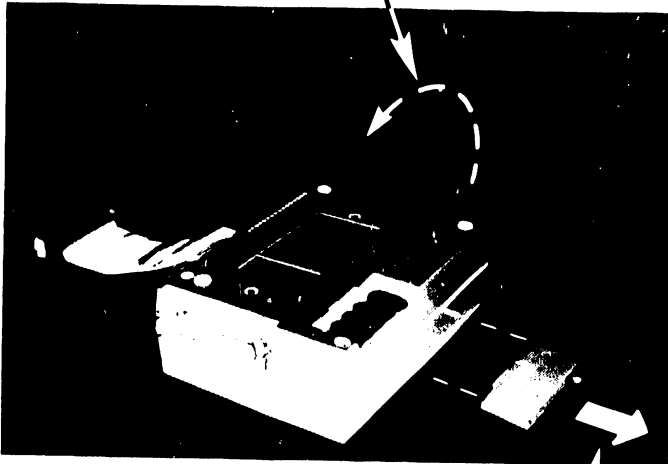

- 2 Snap BATTERY LID open by thumb pressure against textured pressure points on BATTERY LID.

7.5

Removal Procedures, 3.5-Inch FDD

REPAIR

7.5.3 NICAD Battery

CAUTION

Always wear a properly grounded wrist strap whenever any part of WLTC case is open.

The NICAD BATTERY fits into LOWER CASE and is enclosed and protected by BATTERY LID. A 3-wire cable connects to POWER PCB ASSY. NICAD BATTERY may be removed without access to interior of unit.

- 1 Turn unit over to access BATTERY LID.

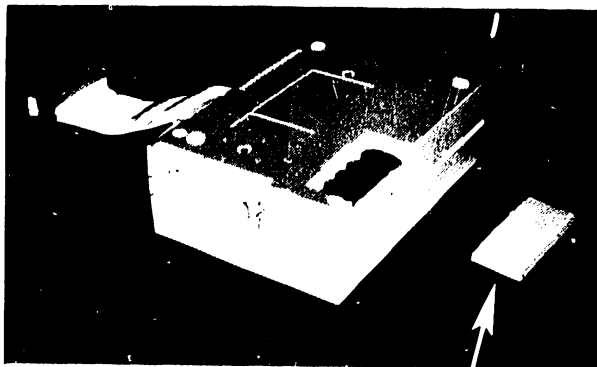

- 2 Remove BATTERY LID (➡ 7.5.1).

- 3 Lift NICAD BATTERY out of compartment.

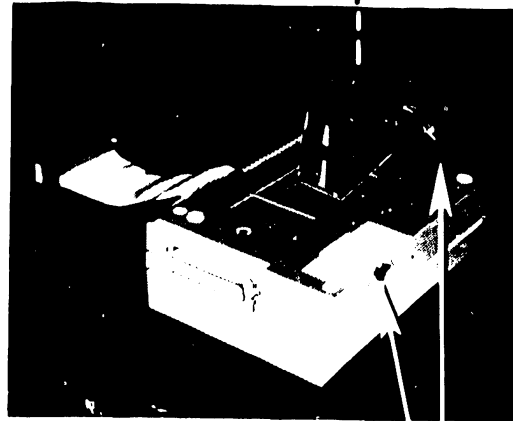

- 4 Unlock and disconnect BATTERY CNN.

7.5

Removal Procedures, 3.5-Inch FDD

REPAIR

7.5.4 Power SW Assembly

CAUTION

Always wear a properly grounded wrist strap whenever any part of WLTC case is open.

The POWER SW ASSY is secured in UPPER CASE by two screws. A 4-wire cable connects to POWER PCB ASSY.

- 1 Access interior of unit (▶ 7.5.1).
- 2 Remove two screws securing POWER SW ASSY to UPPER CASE.

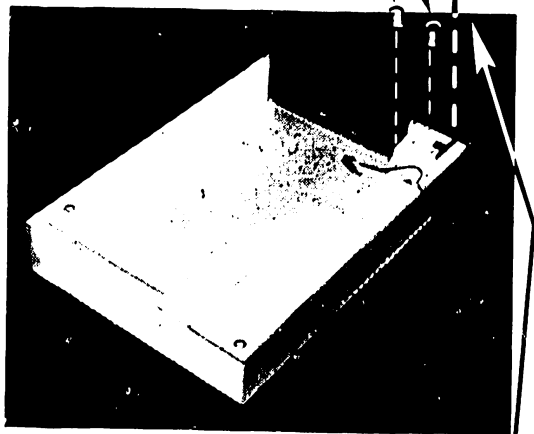

- 3 Lift POWER SW ASSY clear of UPPER CASE.

7.5

Removal Procedures, 3.5-Inch FDD

REPAIR

7.5.5

Power Jack Assembly

CAUTION

Always wear a properly grounded wrist strap whenever any part of WLTC case is open.

The POWER JACK ASSEMBLY is slip fitted into both UPPER and LOWER CASE. Two cables (a 2-wire cable and a ground wire) connect to FDD assembly.

- 1 Access interior of unit (▶ 7.5.1).
- 2 Loosen grounding screw and slip grounding lug away from screw.

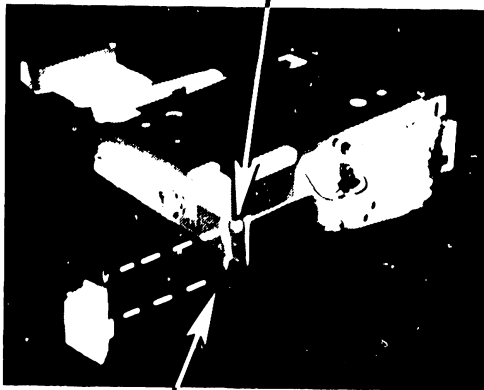

- 3 Disconnect 2-wire cable.

7.5

Removal Procedures, 3.5-Inch FDD

REPAIR

7.5.6

Power PCB Assembly (sheet 1 of 2)

CAUTION

Always wear a properly grounded wrist strap whenever any part of WLTC case is open.

The POWER PCB ASSY is mounted on FDD HOLDER by two screws and standoffs. Four cables connect to FDD, SCSI PCB ASSY, POWER JACK ASSY, and NICAD BATTERY.

- 5 Carefully spread sides of SHIELD and lift away.

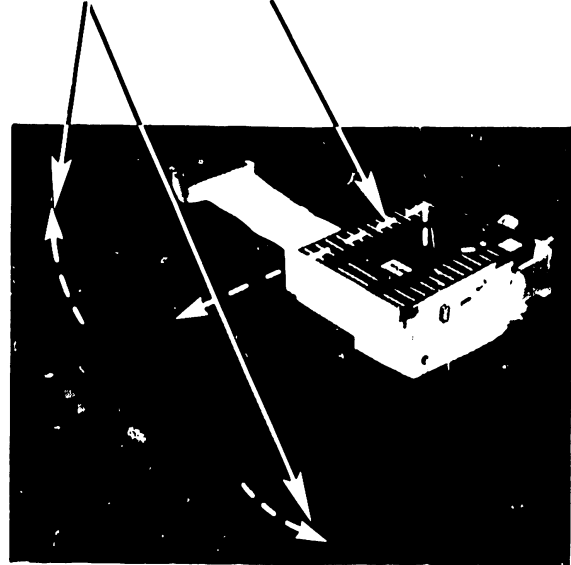

- 1 Access interior of unit (► 7.5.1).
- 2 Remove POWER JACK ASSY (► 7.5.5).
- 3 Turn FDD Assembly over.

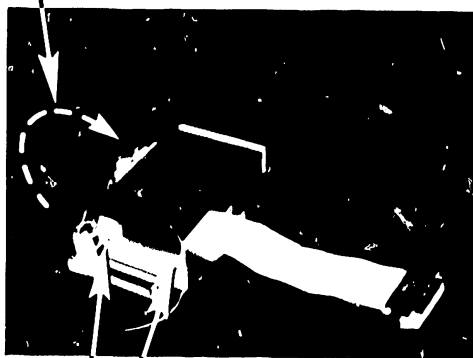

- 4 Remove two screws securing SHIELD.

► NEXT

7.5

Removal Procedures, 3.5-Inch FDD

REPAIR

7.5.6

Power PCB Assembly (sheet 2 of 2)

CAUTION

Always wear a properly grounded wrist strap whenever any part of WLTC case is open.

- 6 Unlock and unplug connectors at FDD and SCSI PCB ASSY.

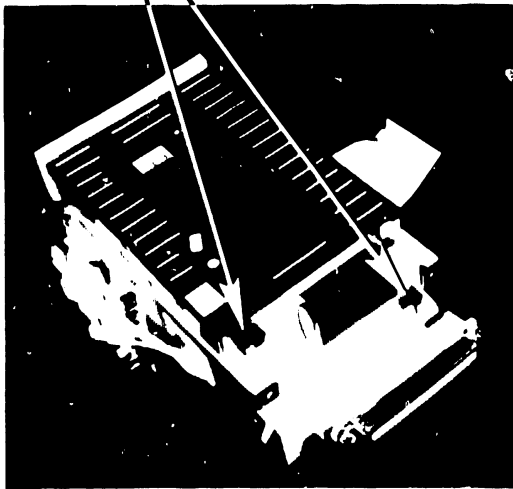

- 7 Carefully withdraw cables through side of FDD HOLDER.

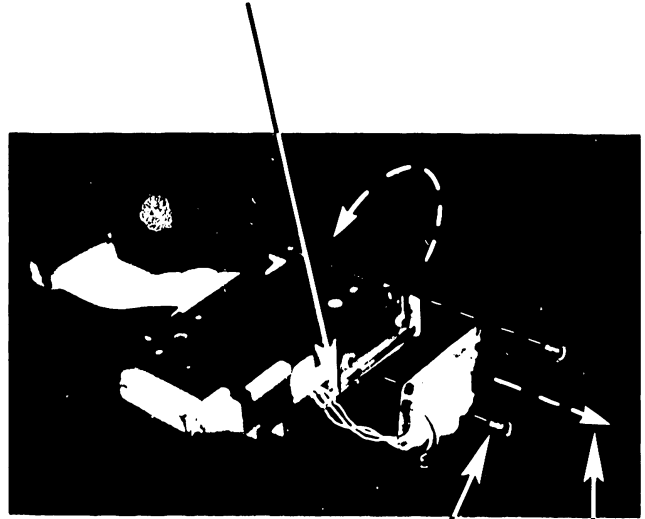

- 8 Remove two mounting screws.
- 9 Lift POWER PCB ASSY away from unit.

◆ END

7.5

Removal Procedures, 3.5-Inch FDD

REPAIR

7.5.7 FDD IF Cable

CAUTION

Always wear a properly grounded wrist strap whenever any part of WLTC case is open.

The FDD IF CABLE, a 34-pin ribbon cable, connects between FDD and SCSI PCB ASSY. Pin-1 (red stripe) is on side away from POWER PCB ASSY.

- 1 Access interior of unit (➡ 7.5.1).
- 2 Remove POWER JACK ASSY (➡ 7.5.5).
- 3 Turn FDD Assembly over.

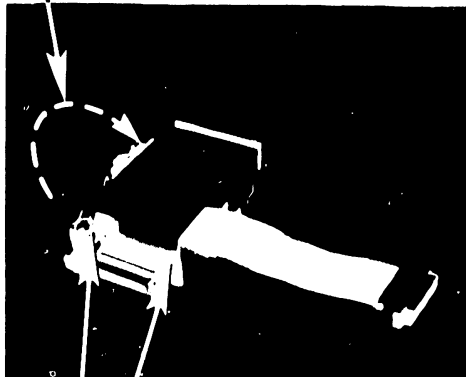

- 4 Remove two screws securing SHIELD.

- 5 Carefully spread sides of SHIELD and lift away.

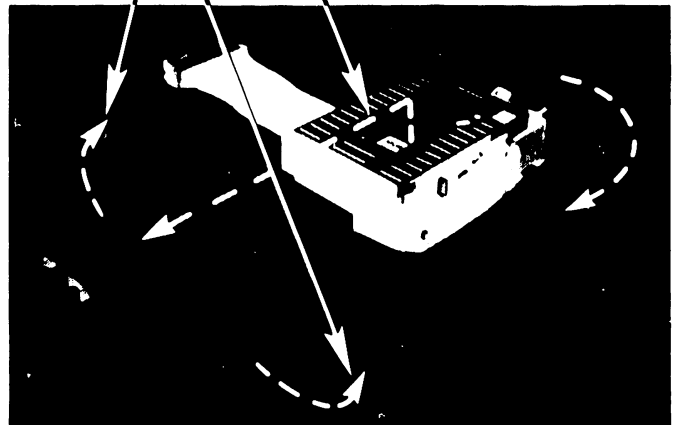

- 6 Unplug FDD IF CABLE at FDD and SCSI PCB ASSY.



7.5

Removal Procedures, 3.5-Inch FDD

REPAIR

7.5.8 FDD (sheet 1 of 2)

CAUTION

Always wear a properly grounded wrist strap whenever any part of WLTC case is open.

The FDD is slip-mounted on FDD HOLDER by way of four shoulder screws; a securing bracket holds the FDD in place. Cables connect to POWER PCB ASSY and SCSI PCB ASSY.

- 1 Access interior of unit (► 7.5.1).
- 2 Remove POWER JACK ASSY (► 7.5.5).
- 3 Remove two screws and securing bracket for FDD.

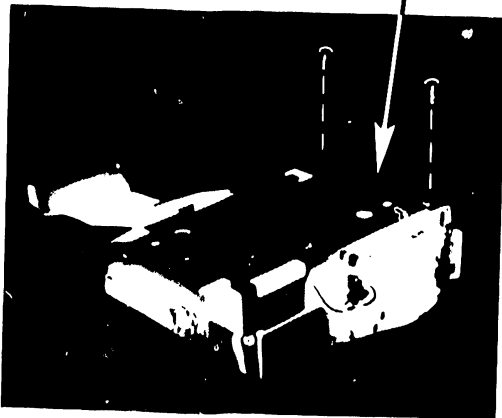

- 4 Turn FDD Assembly over.

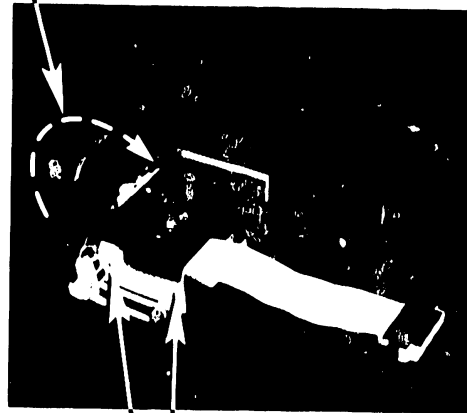

- 5 Remove two screws securing SHIELD.

► NEXT

7.5

Removal Procedures, 3.5-Inch FDD

REPAIR

7.5.8 FDD (sheet 2 of 2)

CAUTION

Always wear a properly grounded wrist strap whenever any part of WLTC case is open.

- 6 Carefully spread sides of SHIELD and lift away.

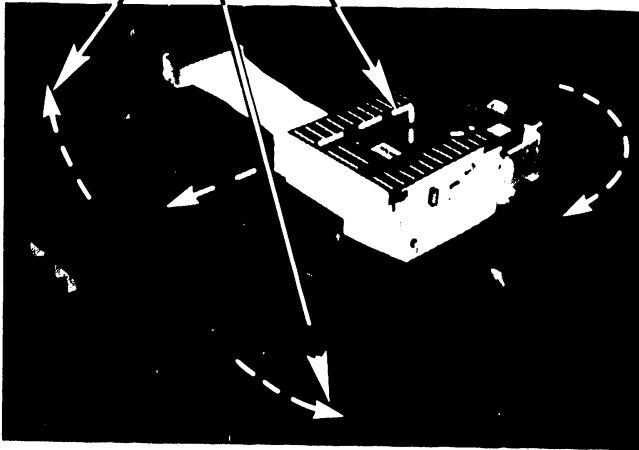

- 7 Disconnect FDD IF CABLE (➡ 7.5.7).

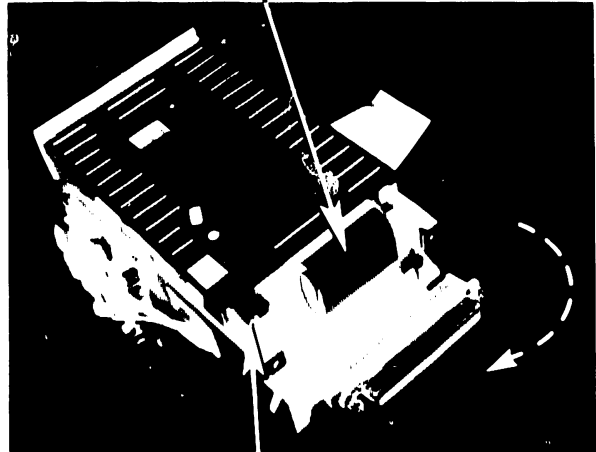

- 8 Unlock and disconnect 2-wire cable from POWER PCB ASSY.

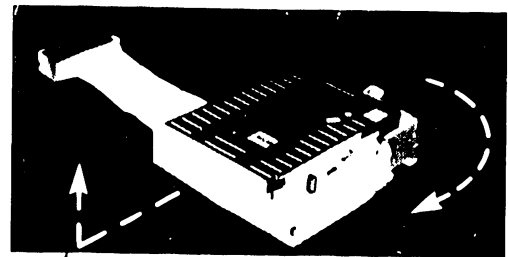

- 9 Slide FDD forward and lift away from FDD HOLDER.

● END

7.5

Removal Procedures, 3.5-Inch FDD

REPAIR

7.5.9 SCSI PCB Assembly

CAUTION

Always wear a properly grounded wrist strap whenever any part of WLTC case is open.

The SCSI PCB ASSY is fitted into two slots in FDD HOLDER and secured by two screws. FDD IF CABLE and SCSI CABLE ASSY connect this assembly. A 3-wire cable connects to POWER PCB ASSY.

- 1 Access interior of unit (➤ 7.5.1).
- 2 Remove POWER JACK ASSY (➤ 7.5.5).
- 3 Remove FDD IF CABLE (➤ 7.5.7).
- 4 Remove FDD (➤ 7.5.8).
- 5 Disconnect a 3-wire cable from POWER PCB ASSY.

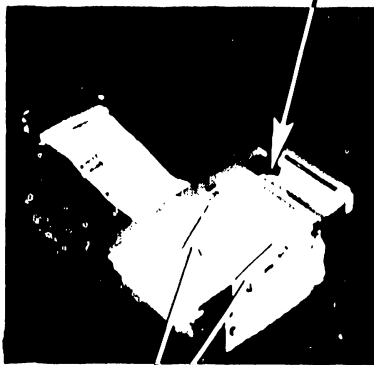

- 6 Remove two screws.

- 7 Slide SCSI PCB ASSY rearward to clear slots: lift front edge.

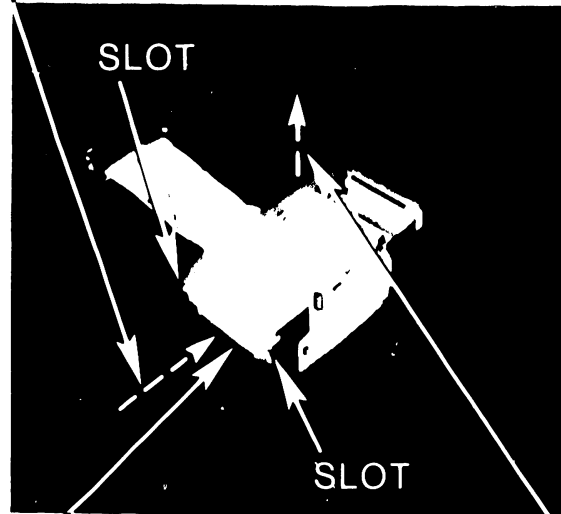

- 8 Disconnect SCSI CABLE ASSY.
- 9 Lift SCSI PCB ASSY away from FDD HOLDER.

7.5

Removal Procedures, 3.5-Inch FDD

REPAIR

7.5.10 SCSI Cable Assembly

CAUTION

Always wear a properly grounded wrist strap whenever any part of WLTC case is open.

- 1 Access interior of unit (➡ 7.5.1).
- 2 Remove POWER JACK ASSY (➡ 7.5.5).
- 3 Remove FDD IF CABLE (➡ 7.5.7).
- 4 Remove FDD (➡ 7.5.8).
- 5 Remove SCSI PCB ASSY (➡ 7.5.9).
- 6 Turn FDD HOLDER over.

- 8 Remove two screws securing SCSI connector.

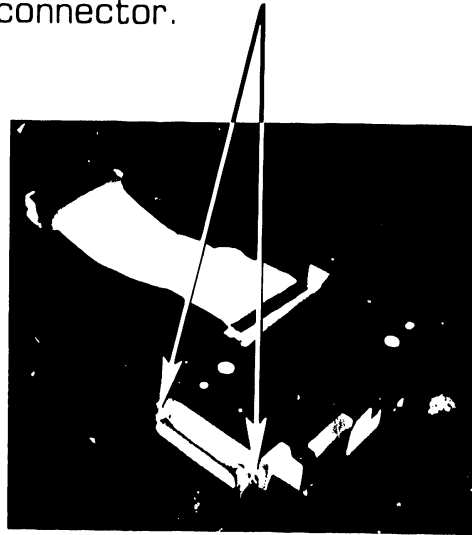

- 9 Fold cable back upon itself.

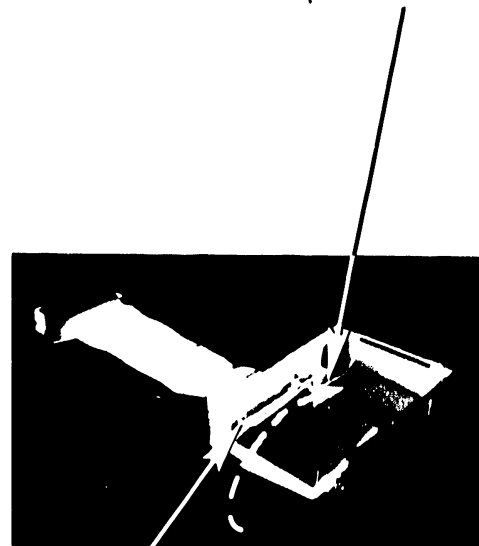
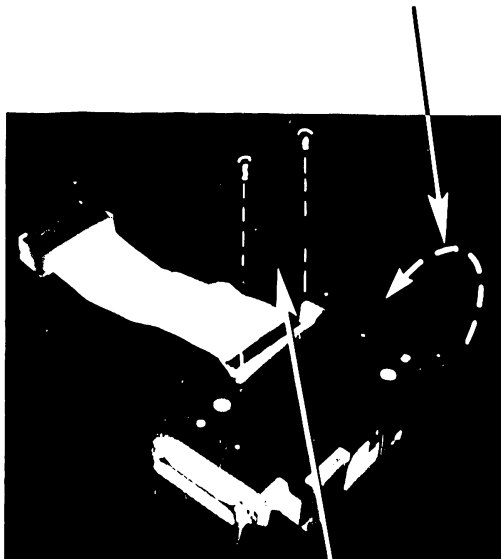

- 7 Remove two screws and cable clamp.

- 10 Carefully slide cable and connectors through side of FDD HOLDER.

7.6

REPAIR

Reinstallation Procedures, 3.5-Inch FDD

7.6.1 Reassembly (sheet 1 of 2)

CAUTION

Always wear a properly grounded wrist strap whenever any part of WLTC case is open.

The 3.5-inch FDD subdivides naturally into four subunits: UPPER CASE (POWER SW ASSY attached), LOWER CASE, NICAD BATTERY, and FDD Assembly (POWER JACK ASSY attached).

NOTE

Reassembly starts with unit upside down.

- 1 Position FDD Assembly over UPPER CASE.

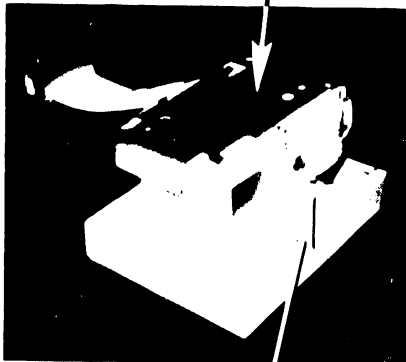

- 2 Connect 4-wire cable from POWER SW ASSY.

- 3 Carefully fit FDD Assembly into UPPER CASE.

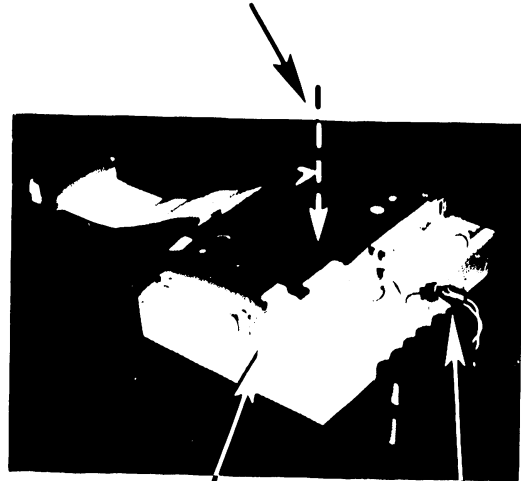

- 4 Fit slotted edge of POWER JACK ASSY into position.

- 5 Connect BATTERY CONNECTOR.

➡ NEXT

7.6

REPAIR

Reinstallation Procedures, 3.5-Inch FDD

7.6.1 Reassembly (sheet 2 of 2)

CAUTION

Always wear a properly grounded wrist strap whenever any part of WLTC case is open.

- 9 Install four screws in LOWER CASE : Tighten

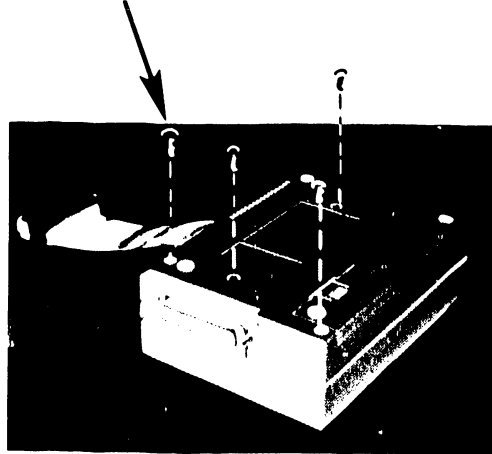

- 10 Turn unit right side up.

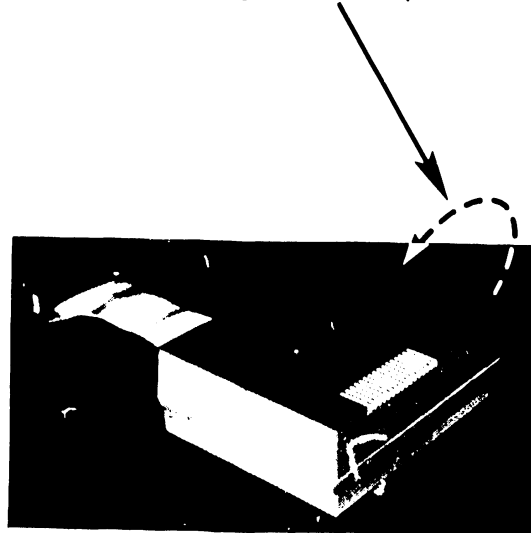

- 6 Fit NICAD BATTERY into UPPER CASE.

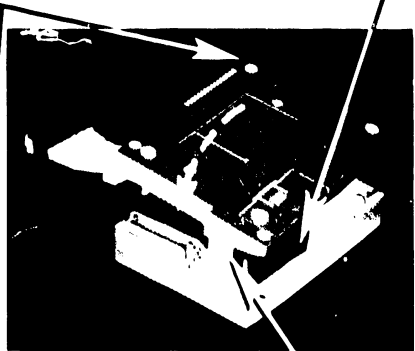

- 7 Hook front of LOWER CASE onto front edge of UPPER CASE.

- 8 Taking care to fit slotted edges of POWER JACK ASSY into position on LOWER CASE, swing down LOWER CASE and adjust fit.

● END

7.6

Reinstallation Procedures, 3.5-Inch FDD

REPAIR

7.6.2

Battery Lid

CAUTION

Always wear a properly grounded wrist strap whenever any part of WLTC case is open.

The BATTERY LID encloses and protects NICAD BATTERY. It is snap fitted to LOWER CASE. BATTERY LID may be removed without access to interior of unit.

- 1 Turn unit over to access battery compartment.

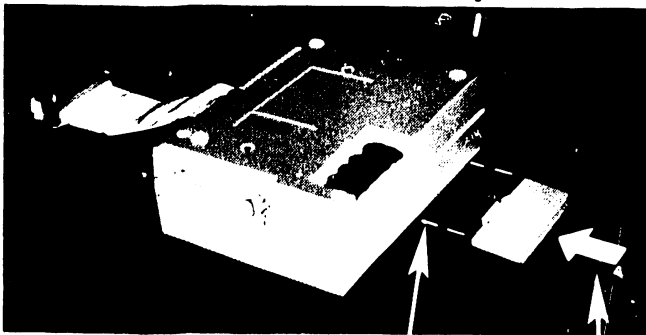

- 2 Slide BATTERY LID onto grooves in LOWER CASE
- 3 Push closed until catch snaps shut.

7.6

Reinstallation Procedures, 3.5-Inch FDD

REPAIR

7.6.3 NICAD Battery

CAUTION

Always wear a properly grounded wrist strap whenever any part of WLTC case is open.

The NICAD BATTERY fits into LOWER CASE and is enclosed and protected by BATTERY LID. A 3-wire cable connects to POWER PCB ASSY. NICAD BATTERY may be removed without access to interior of unit.

- 1 Turn unit over to access battery compartment.

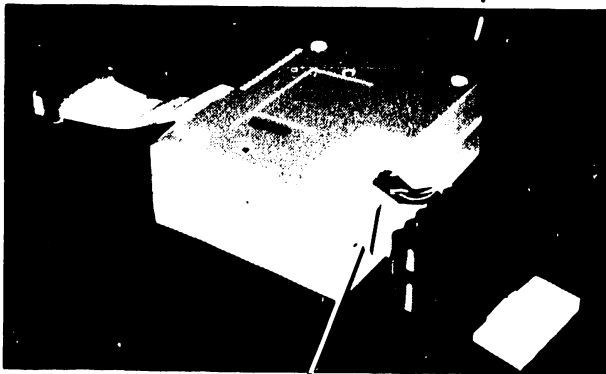

- 2 Connect BATTERY CNN.

- 3 Dress leads into case to clear battery compartment.

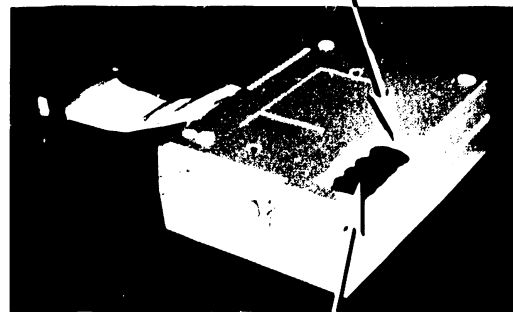

- 4 Fit NICAD BATTERY into battery compartment.
- 5 Reinstall BATTERY LID (➡ 7.6.2).

7.6

REPAIR

Reinstallation Procedures, 3.5-Inch FDD

7.6.4 Power SW Assembly

CAUTION

Always wear a properly grounded wrist strap whenever any part of WLTC case is open.

The POWER SW ASSY is secured in UPPER CASE by two screws. A 4-wire cable connects to POWER PCB ASSY.

- 1 Fit POWER SW ASSY into UPPER CASE.

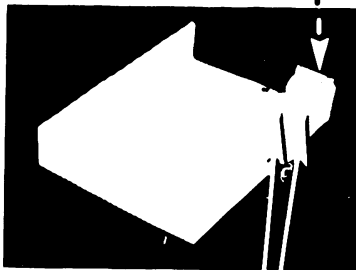

- 2 Secure in place with two screws.

- 3 Position FDD Assembly over UPPER CASE.

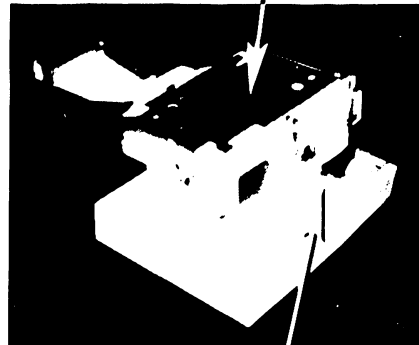

- 4 Connect 4-wire cable to POWER PCB ASSY.

- 5 Refit FDD Assembly into UPPER CASE.

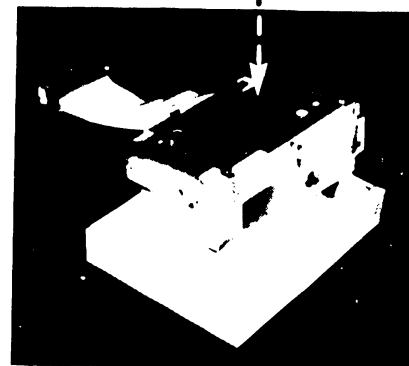

- 6 Reassemble unit (▶ 7.6.1).

7.6

Reinstallation Procedures, 3.5-Inch FDD

REPAIR

7.6.5 Power Jack Assembly

CAUTION

Always wear a properly grounded wrist strap whenever any part of WLTC case is open.

The POWER JACK ASSEMBLY is slip fitted into both UPPER and LOWER CASE. Two cables (a 2-wire cable and a ground wire) connect to FDD assembly.

- 1 Carefully lift FDD Assembly enough to clear UPPER CASE.

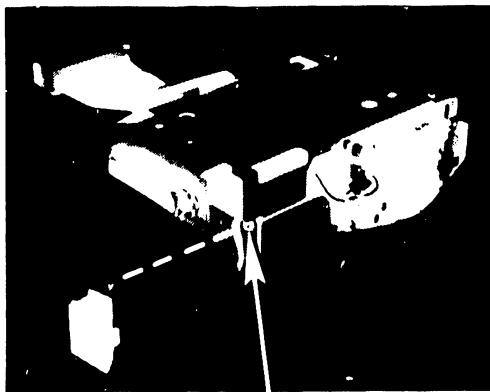

- 2 Connect grounding lug under screw securing shield to FDD Assembly.

- 3 Connect 2-wire cable from POWER PCB ASSY.

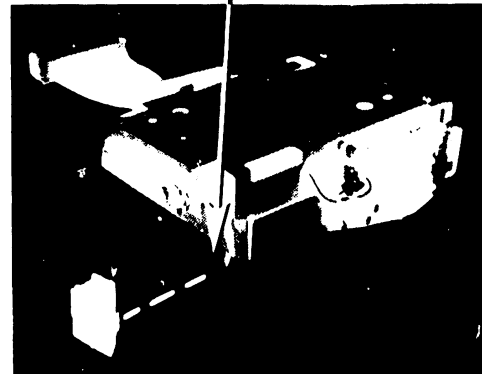

- 4 Reassemble unit (➡ 7.6.1).

7.6

Reinstallation Procedures, 3.5-Inch FDD

REPAIR

7.6.6

Power PCB Assembly (sheet 1 of 2)

CAUTION

Always wear a properly grounded wrist strap whenever any part of WLTC case is open.

The POWER PCB ASSY is mounted on FDD HOLDER by two screws and stand-offs. Four cables connect to FDD, SCSI PCB ASSY, POWER JACK ASSY, and NICAD BATTERY.

- 1 Position POWER PCB ASSY against side of FDD HOLDER.

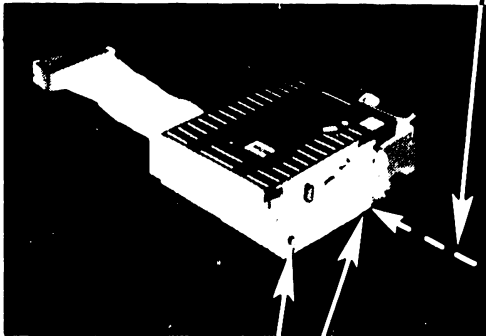

- 2 Install two mounting screws: tighten.

- 3 Carefully dress *three* cables through side of FDD HOLDER and *between* SCSI PCB ASSY and FDD HOLDER:
 - a. 2-wire cable to FDD
 - b. 3-wire cable to SCSI PCB ASSY
 - c. 2-wire cable to POWER JACK ASSY.

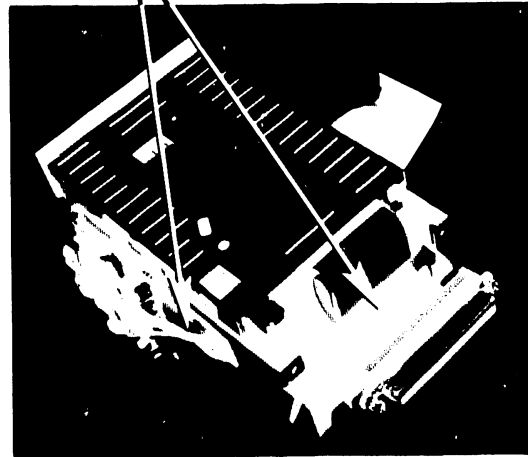

- 4 Connect cables to FDD and SCSI PCB ASSY.

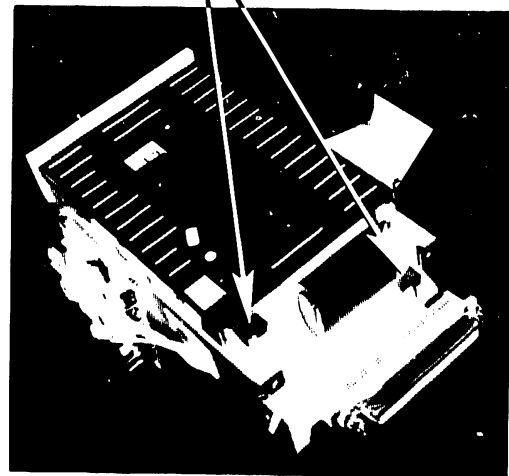

➡ NEXT

7.6

Reinstallation Procedures, 3.5-Inch FDD

REPAIR

7.6.6

Power PCB Assembly (sheet 2 of 2)

CAUTION

Always wear a properly grounded wrist strap whenever any part of WLTC case is open.

- 5 Carefully spread sides of SHIELD and fit down over FDD.

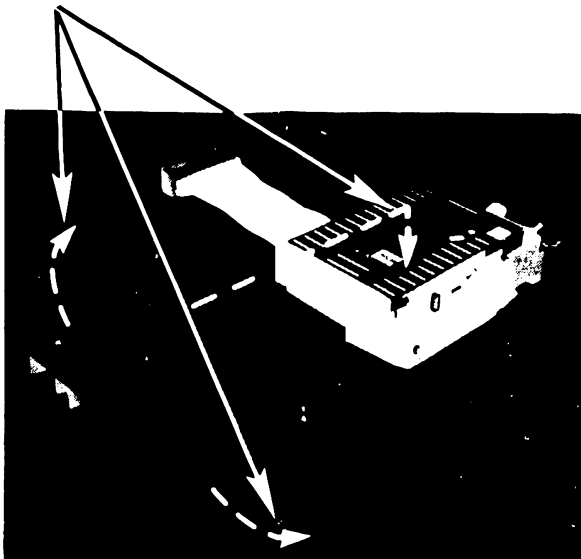

- 6 Secure SHIELD with two screws.

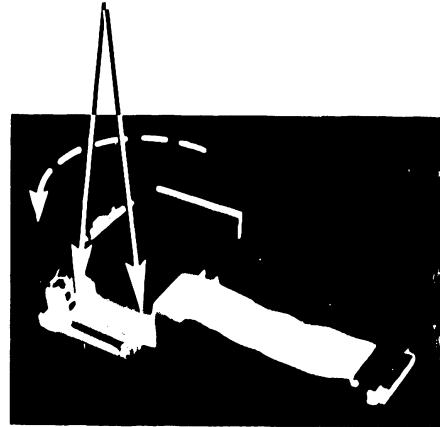

- 7 Reinstall POWER JACK ASSY (▶ 7.6.5).
- 8 Reassemble unit (▶ 7.6.1).

● END

7.6

Reinstallation Procedures, 3.5-Inch FDD

REPAIR

7.6.7 FDD IF Cable

CAUTION

Always wear a properly grounded wrist strap whenever any part of WLTC case is open.

The FDD IF CABLE, a 34-pin ribbon cable, connects between FDD and SCSI PCB ASSY. Pin-1 (red stripe) is on side away from POWER PCB ASSY.

- 1 Plug FDD IF CABLE into:
 - a. FDD
 - b. SCSI PCB ASSY.

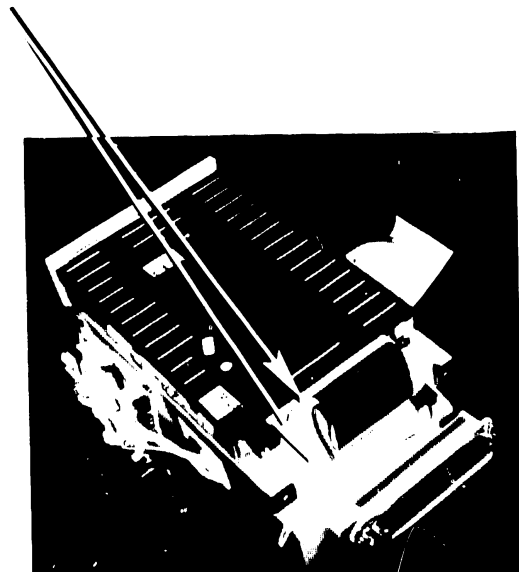

- 2 Carefully spread sides of SHIELD and fit down over FDD.

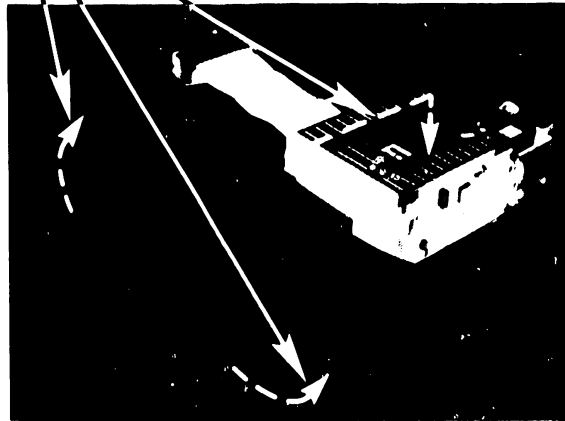

- 3 Secure SHIELD with two screws.

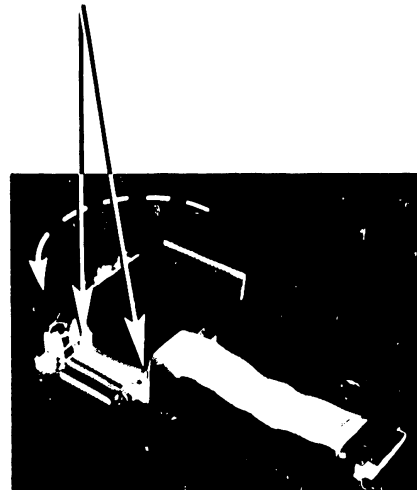

- 4 Reinstall POWER JACK ASSY (➤ 7.6.5).
- 5 Reassemble unit (➤ 7.6.1).

7.6

Reinstallation Procedures, 3.5-Inch FDD

REPAIR

7.6.8 FDD (sheet 1 of 2)

CAUTION

Always wear a properly grounded wrist strap whenever any part of WLTC case is open.

The FDD is slip-mounted on FDD HOLDER by way of four shoulder screws; a securing bracket holds the FDD in place. Cables connect to POWER PCB ASSY and SCSI PCB ASSY.

- 1 Fit FDD into FDD HOLDER and slide back into position.

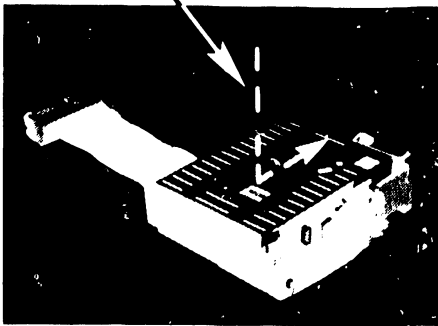

- 2 Connect 2-wire cable from POWER PCB ASSY.

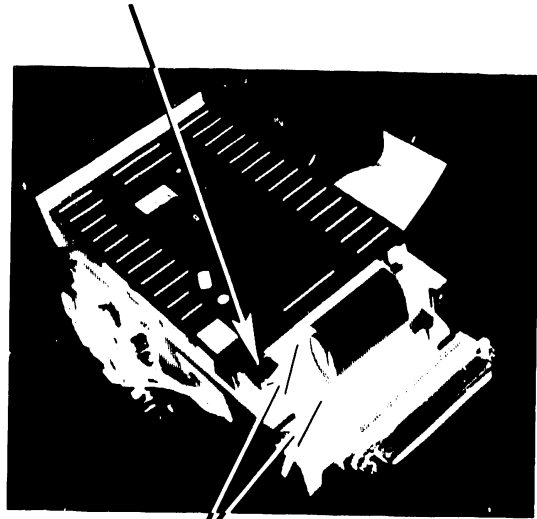

- 3 Connect FDD IF CABLE (➡ 7.6.7).

- 4 Carefully spread sides of SHIELD and fit down over FDD.

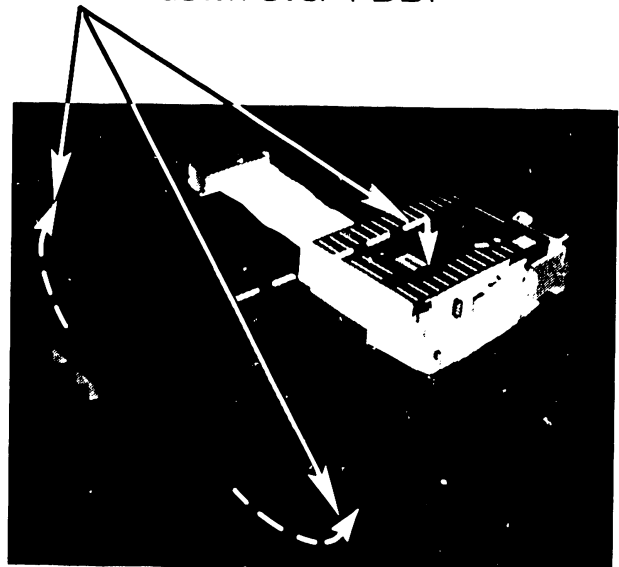

➡ NEXT

7.6

Reinstallation Procedures, 3.5-Inch FDD

REPAIR

7.6.8 FDD (sheet 2 of 2)

CAUTION

Always wear a properly grounded wrist strap whenever any part of WLTC case is open.

- 5 Secure SHIELD with two screws.

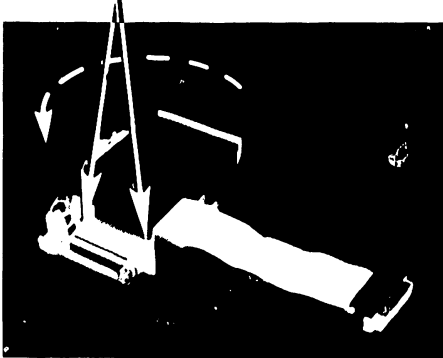

- 6 Turn FDD Assembly over.

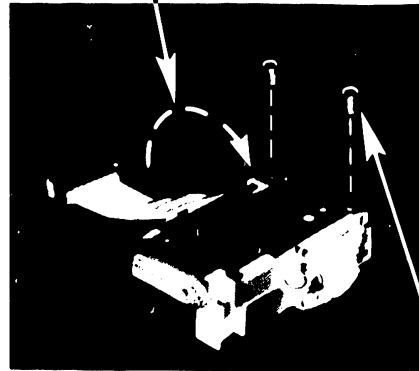

- 7 Fit securing bracket into place and secure with two screws.
- 8 Reinstall POWER JACK ASSY (➡ 7.6.5).
- 9 Reassemble unit (➡ 7.6.1).

◆ END

7.6

Reinstallation Procedures, 3.5-Inch FDD

REPAIR

7.6.9 SCSI PCB Assembly (sheet 1 of 2)

CAUTION

Always wear a properly grounded wrist strap whenever any part of WLTC case is open.

The SCSI PCB ASSY is fitted into two slots in FDD HOLDER and secured by two screws. FDD IF CABLE and SCSI CABLE ASSY connect this assembly. A 3-wire cable connects to POWER PCB ASSY.

- 1 Ensure jumpers are correctly connected on header C18.

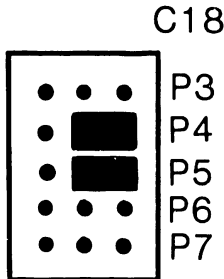

- 2 Fit SCSI PCB ASSY into FDD HOLDER.

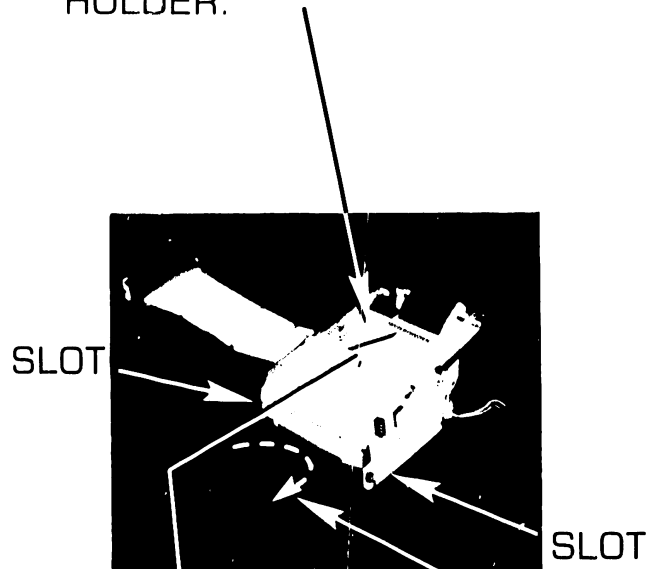

- 3 Connect SCSI CABLE ASSY.
- 4 Slide SCSI PCB ASSY rearward to clear flanges; then forward into slots.

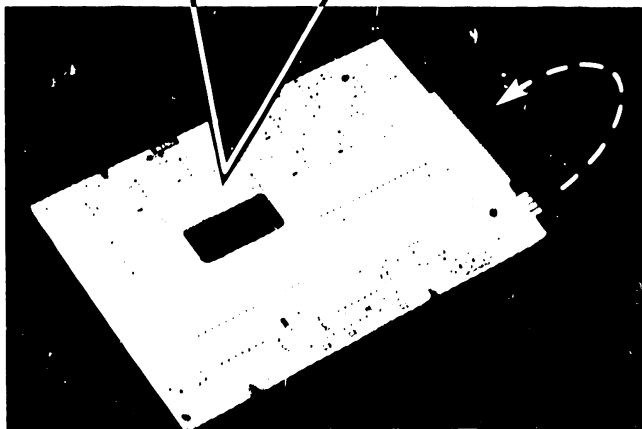

▶ NEXT

7.6

REPAIR

Reinstallation Procedures, 3.5-Inch FDD

7.6.9 SCSI PCB Assembly(sheet 2 of 2)

CAUTION

Always wear a properly grounded wrist strap whenever any part of WLTC case is open.

- 7 Install FDD (▶ 7.6.8).
- 8 Install FDD IF CABLE (▶ 7.6.7).
- 9 Install POWER JACK ASSY (▶ 7.6.5).
- 10 Reassemble unit (▶ 7.6.1).

- 5 Install two screws.

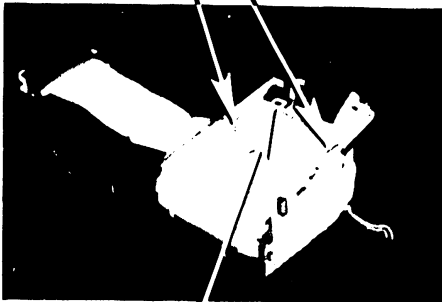

- 6 Connect 3-wire cable from POWER PCB ASSY.

◆ END

7.6

Reinstallation Procedures, 3.5-Inch FDD

REPAIR

7.6.10 SCSI Cable Assembly

CAUTION

Always wear a properly grounded wrist strap whenever any part of WLTC case is open.

- 1 Fold cable back upon itself.

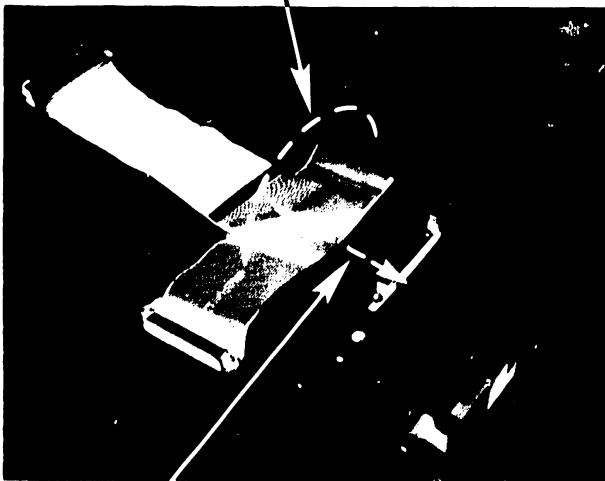

- 2 Carefully slide folded cable and connectors through side of FDD HOLDER.

- 3 Secure SCSI connector with two screws.

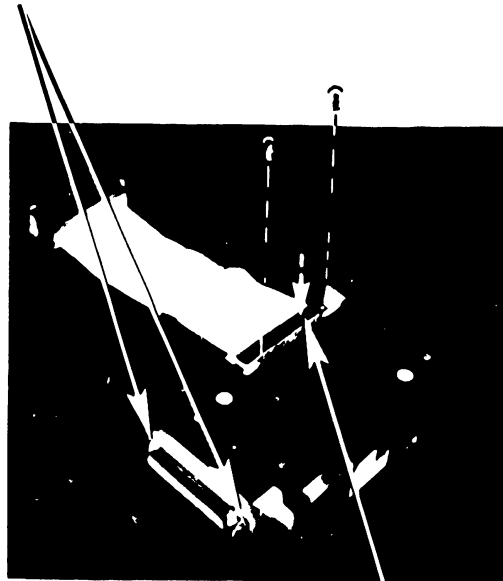

- 4 Fit cable clamp in place and secure with two screws.
- 5 Install SCSI PCB ASSY (▶ 7.6.9).
- 6 Install FDD (▶ 7.6.8).
- 7 Install FDD IF CABLE (▶ 7.6.7).
- 8 Install POWER PCB ASSY (▶ 7.6.6).
- 9 Install POWER JACK ASSY (▶ 7.6.5).
- 10 Reassemble unit (▶ 7.6.1).

7.7

Removal Procedures, 5.25-Inch FDD

REPAIR

7.7.1 Access (sheet 1 of 2)

CAUTION

Always wear a properly grounded wrist strap whenever any part of WLTC case is open.

The 5.25-inch FDD is easily accessed by removing UPPER CASE and LOWER CASE.

- 1 Turn unit over to access screws securing LOWER CASE.

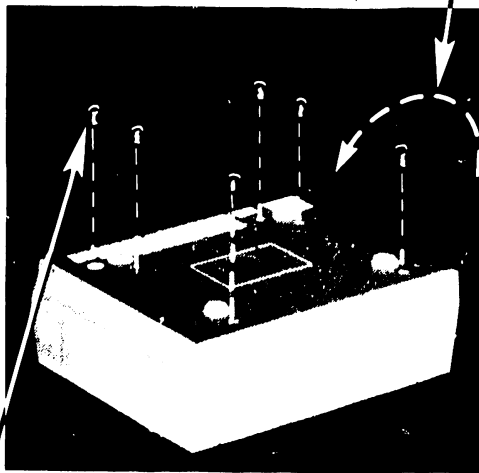

- 2 Remove six screws securing LOWER CASE.

- 3 Lift off LOWER CASE.

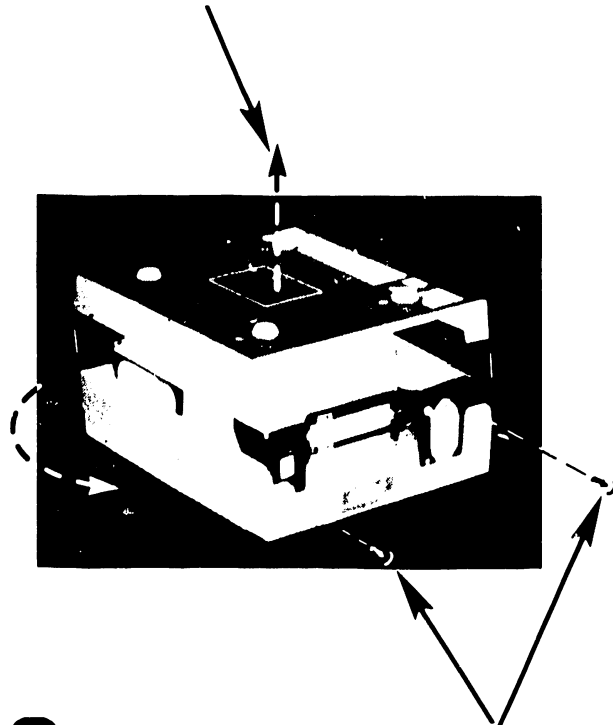

- 4 Remove two screws at rear.

▶ NEXT

7.7

Removal Procedures, 5.25-Inch FDD

REPAIR

7.7.1 Access (sheet 2 of 2)

CAUTION

Always wear a properly grounded wrist strap whenever any part of WLTC case is open.

- 5 Turn unit over again.

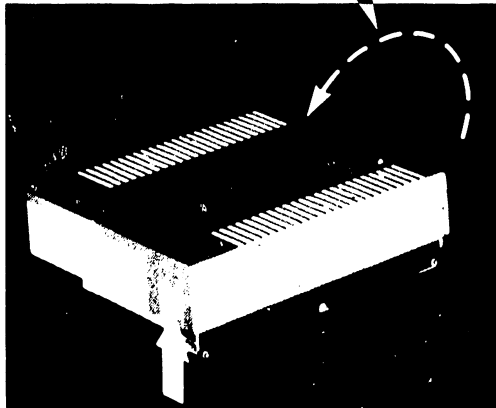

- 6 Place POWER SWITCH in "up" position (on).

CAUTION

Ensure POWER SWITCH is in "up" position, lift UPPER CASE from rear, and raise UPPER CASE carefully to disengage POWER SWITCH. Switch-actuating tabs in UPPER CASE are easily broken.

- 7 Lift off UPPER CASE.

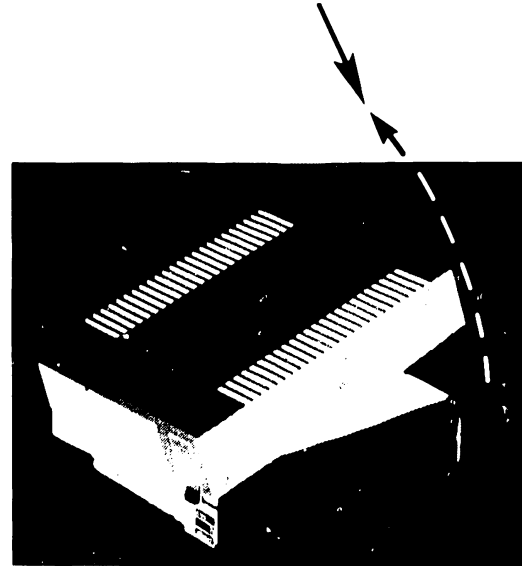

● END

7.7

Removal Procedures, 5.25-Inch FDD

REPAIR

7.7.2

Power PCB Assembly (sheet 1 of 2)

CAUTION

Always wear a properly grounded wrist strap whenever any part of WLTC case is open.

The POWER PCB ASSY is secured to FDD HOLDER by three screws: cables connect to FDD and SCSI PCB ASSY.

- 1 Access unit (➡ 7.7.1).
- 2 Disconnect 6-wire connector from FDD.

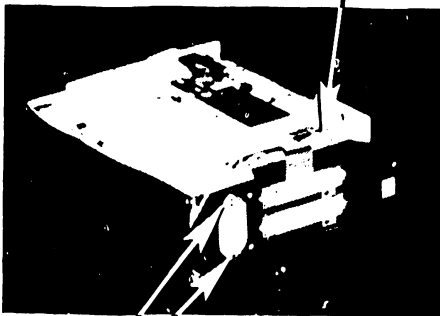

- 3 Remove two screws at rear.

- 4 Loosen (do not remove) single screw at front.

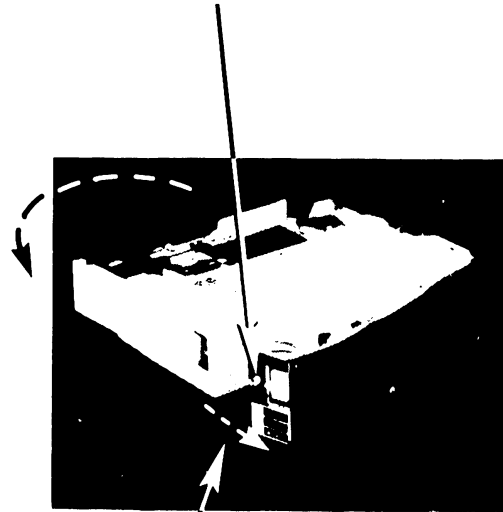

- 5 Slide loosened screw out of its slot.

➡ NEXT

7.7

Removal Procedures, 5.25-Inch FDD

REPAIR

7.7.2

Power PCB Assembly (sheet 2 of 2)

CAUTION

Always wear a properly grounded wrist strap whenever any part of WLTC case is open.

- 6 Move POWER PCB ASSY away from unit to expose SHIELD.

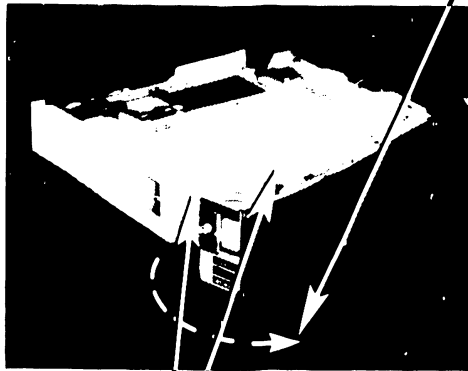

- 7 Remove two screws securing SHIELD.

NOTE

The two screws securing SHIELD also secure one side of FDD.

- 8 Lift SHIELD away from unit.

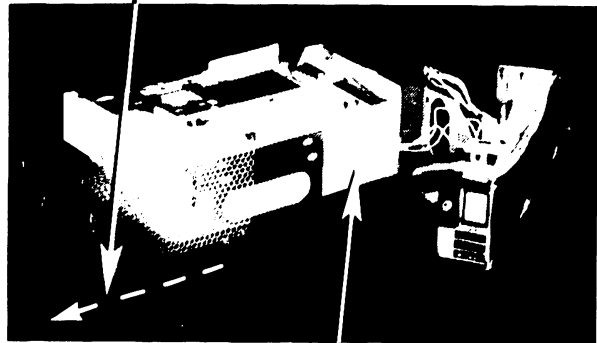

- 9 Disconnect 3-wire cable from SCSI PCB ASSY.

7.7

Removal Procedures, 5.25-Inch FDD

REPAIR

7.7.3

FDD

CAUTION

Always wear a properly grounded wrist strap whenever any part of WLTC case is open.

The FDD is secured to FDD HOLDER by four screws. Power cables connect to POWER PCB ASSY and SCSI PCB ASSY; a ribbon cable connects to SCSI PCB ASSY.

- 1 Access unit (► 7.7.1).
- 2 Remove POWER PCB ASSY (► 7.7.2).
- 3 Remove remaining two screws securing FDD to HOLDER.

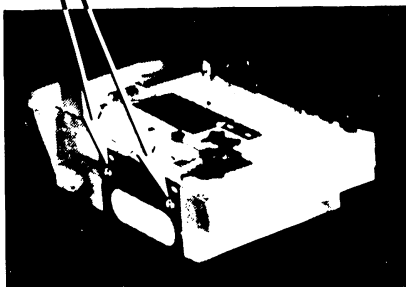

- 4 Slide FDD forward.

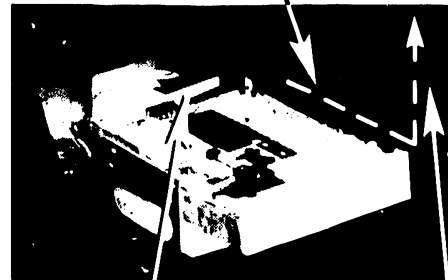

- 5 Disconnect ribbon cable to SCSI PCB ASSY.
- 6 Lift FDD away from HOLDER.

7.7

Removal Procedures, 5.25-Inch FDD

REPAIR

7.7.4 SCSI PCB ASSEMBLY

CAUTION

Always wear a properly grounded wrist strap whenever any part of WLTC case is open.

The SCSI PCB ASSY is secured to FDD HOLDER by four screws. Ribbon cables connect to FDD and external connectors; a 4-wire cable connects to Device ID switch.

- 1 Access unit (► 7.7.1).
- 2 Remove POWER PCB ASSY (► 7.7.2).
- 3 Remove FDD (► 7.7.3).
- 4 Disconnect 4-wire cable from Device ID switch.

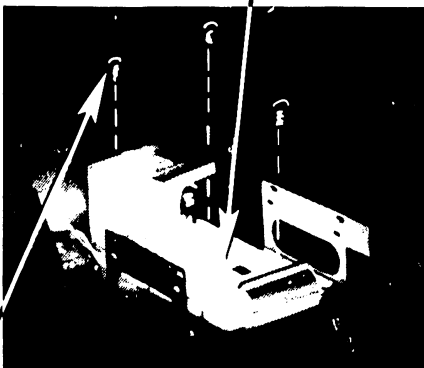

- 6 Lift SCSI PCB ASSY away from HOLDER.

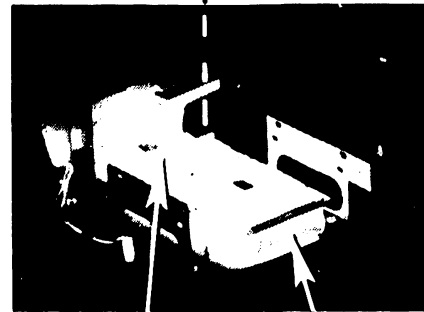

- 7 Disconnect ribbon cable to FDD.
- 8 Disconnect SCSI BUS CABLE.

- 5 Remove four screws securing SCSI PCB ASSY to HOLDER.

7.7

Removal Procedures, 5.25-Inch FDD

REPAIR

7.7.5 SCSI BUS Cable

CAUTION

Always wear a properly grounded wrist strap whenever any part of WLTC case is open.

The SCSI BUS CABLE is secured to FDD HOLDER by four screws fastening its external connectors. It connects to SCSI PCB ASSY.

- 1 Access unit (▶ 7.7.1).
- 2 Remove POWER PCB ASSY (▶ 7.7.2).
- 3 Remove FDD (▶ 7.7.3).
- 4 Remove SCSI PCB ASSY (▶ 7.7.4).
- 5 Remove four screws securing external connectors.

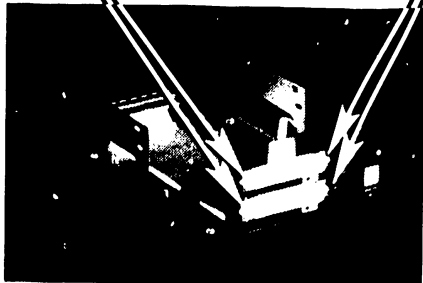

- 6 Carefully withdraw connector "ears" through FDD HOLDER.

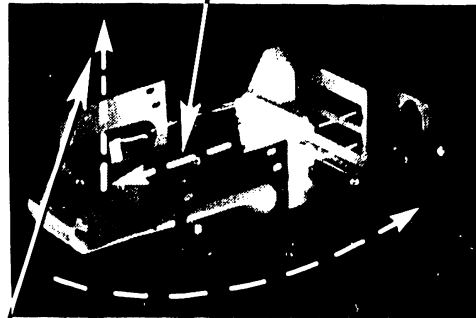

- 7 Lift SCSI BUS CABLE away from HOLDER.

7.8

Reinstallation Procedures, 5.25-Inch FDD

REPAIR

7.8.1 Reassembly (sheet 1 of 2)

CAUTION

Always wear a properly grounded wrist strap whenever any part of WLTC case is open.

The 5.25-inch FDD is easily accessed by removing UPPER CASE and LOWER CASE.

- 1 Fit unit into LOWER CASE by guiding pylon on LOWER CASE up between FDD and POWER PCB ASSY.

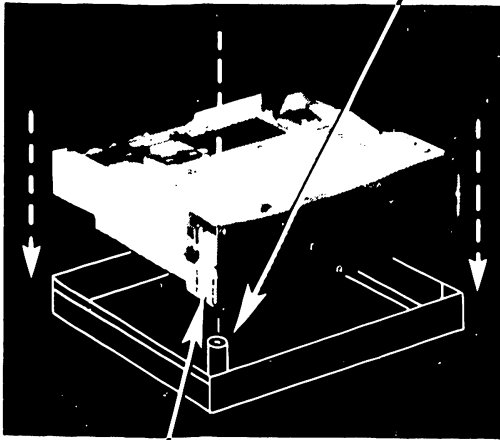

- 2 Place POWER SWITCH in "up" position (on).

CAUTION

Ensure POWER SWITCH is in "up" position, before fitting UPPER CASE. Switch-actuating tabs in UPPER CASE are easily broken.

- 3 Fit UPPER CASE onto unit to engage switch actuator onto switch lever.

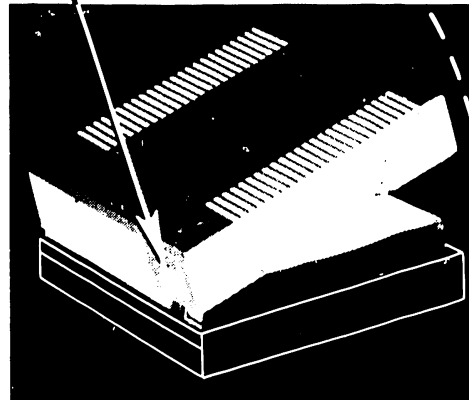

- 4 Swing down rear of UPPER CASE and adjust fit.

➡ NEXT

7.8

Reinstallation Procedures, 5.25-Inch FDD

REPAIR

7.8.1 Reassembly (sheet 2 of 2)

CAUTION

Always wear a properly grounded wrist strap whenever any part of WLTC case is open.

7 Install two screws at rear.

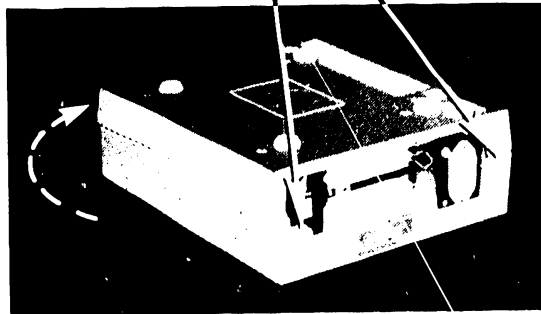

5 Turn unit over.

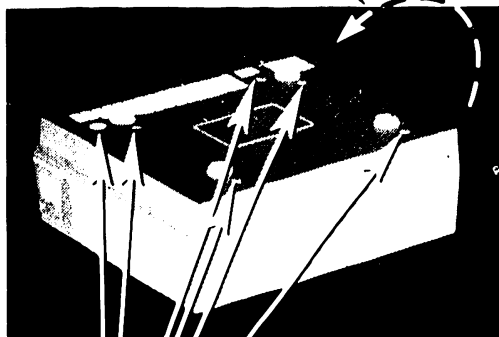

8 Turn unit right side up.

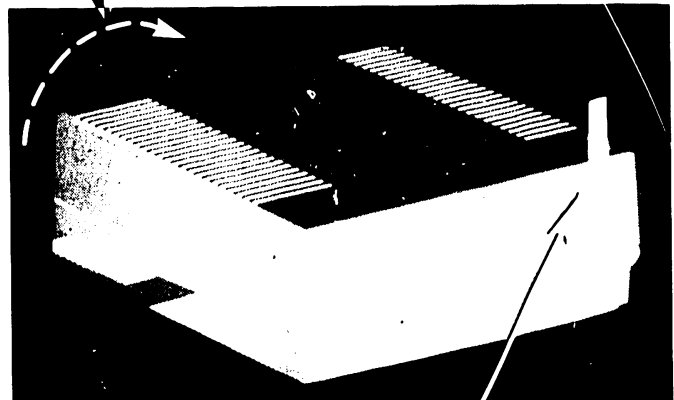

6 Install six mounting screws: Tighten.

9 Turn POWER SWITCH off.

◆ END

7.8

Reinstallation Procedures, 5.25-Inch FDD

REPAIR

7.8.2

Power PCB Assembly (sheet 1 of 3)

CAUTION

Always wear a properly grounded wrist strap whenever any part of WLTC case is open.

The POWER PCB ASSY is secured to FDD HOLDER by three screws: cables connect to FDD and SCSI PCB ASSY.

NOTE

The two screws securing SHIELD also secures one side of FDD.

- 1 Remove two screws securing SHIELD.

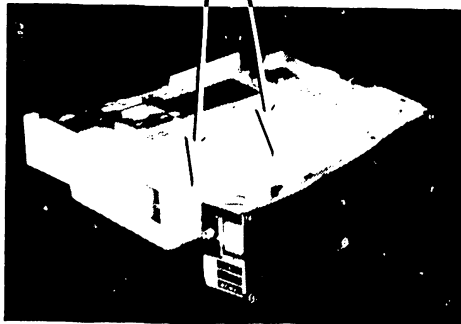

- 2 Lift SHIELD away from unit.

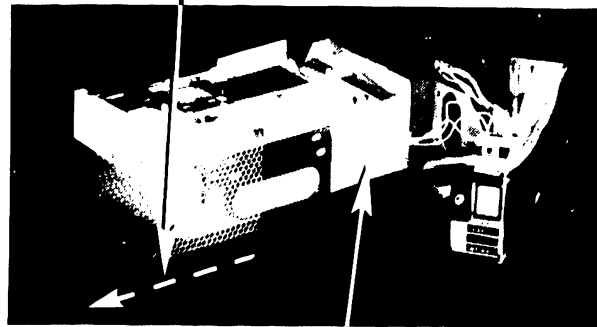

- 3 Connect 3-wire cable to SCSI PCB ASSY.

➡ NEXT

7.8

Reinstallation Procedures, 5.25-Inch FDD

REPAIR

7.8.2

Power PCB Assembly (sheet 2 of 3)

CAUTION

Always wear a properly grounded wrist strap whenever any part of WLTC case is open.

NOTE

The two screws securing SHIELD also secures one side of FDD.

- 4 Refit SHIELD.

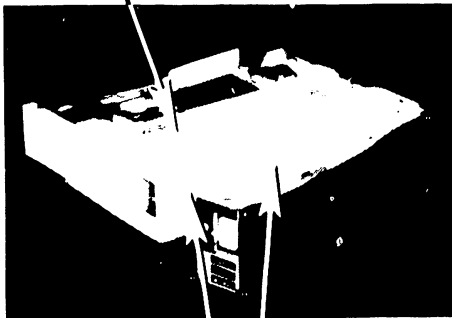

- 5 Secure with two screws.

- 6 Connect 6-wire connector at FDD.

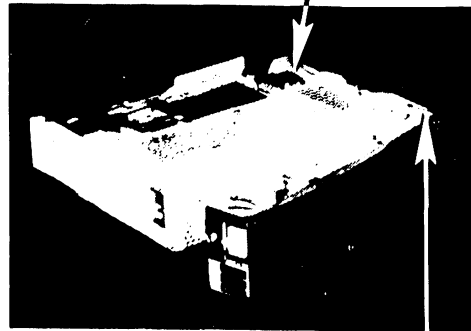

- 7 Fit ac connector on POWER SUPPLY ASSY into FDD HOLDER.

- 8 Slide front mounting screw into its slot: Tighten.

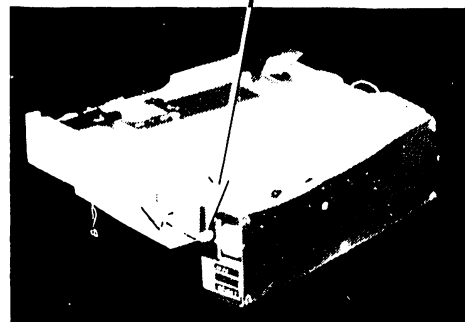

➡ NEXT

7.8

REPAIR

Reinstallation Procedures, 5.25-Inch FDD

7.8.2 Power PCB Assembly (sheet 3 of 3)

CAUTION

Always wear a properly grounded wrist strap whenever any part of WLTC case is open.

- 9 Install two screws at rear: Tighten

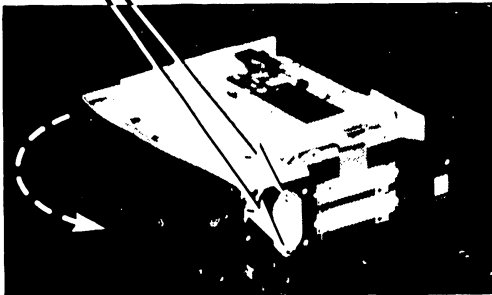

- 10 Reassemble unit (▶ 7.8.1).

● END

7.8

Reinstallation Procedures, 5.25-Inch FDD

REPAIR

7.8.3

FDD

CAUTION

Always wear a properly grounded wrist strap whenever any part of WLTC case is open.

The FDD is secured to FDD HOLDER by four screws. Power cables connect to POWER PCB ASSY and SCSI PCB ASSY; a ribbon cable connects to SCSI PCB ASSY.

- 1 Fit FDD into HOLDER. PCB ASSY.
- 2 Connect ribbon cable from SCSI PCB ASSY.

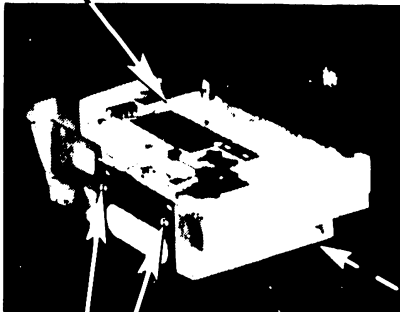

- 3 Install two mounting screws on side opposite POWER PCB.

NOTE

The two screws securing SHIELD also secure one side of FDD.

- 4 Fit SHIELD into place.

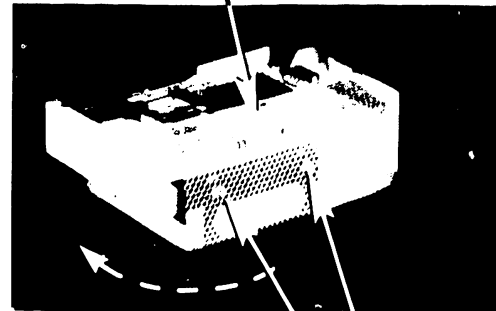

- 5 Install two mounting screws that remain.
- 6 Reinstall POWER PCB ASSY (► 7.8.2).
- 7 Reassemble unit (► 7.8.1).

7.8

Reinstallation Procedures, 5.25-Inch FDD

REPAIR

7.8.4 SCSI PCB ASSEMBLY

CAUTION

Always wear a properly grounded wrist strap whenever any part of WLTC case is open.

The SCSI PCB ASSY is secured to FDD HOLDER by four screws. Ribbon cables connect to FDD and external connectors; a 4-wire cable connects to Device ID switch.

1 Connect SCSI BUS CABLE.

2 Connect FDD ribbon-cable.

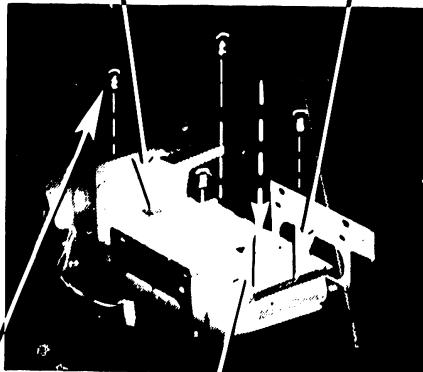

3 Fit SCSI PCB ASSY into HOLDER.

4 Install four screws securing SCSI PCB ASSY to HOLDER.

5 Connect 4-wire cable from Device ID switch.

JUMPERS

C18

P3

P4

P5

P6

P7

4-WIRE

CABLE TO ID SW

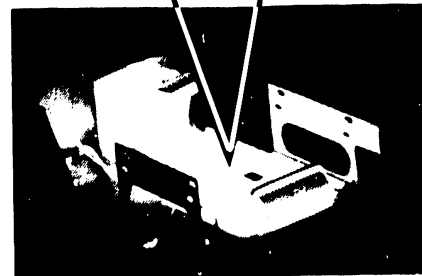

6 Reinstall FDD (➤ 7.8.3).

7 Reinstall POWER PCB ASSY (➤ 7.8.2).

8 Reassemble unit (➤ 7.8.1).

7.8

Reinstallation Procedures, 5.25-Inch FDD

REPAIR

7.8.5 SCSI BUS Cable

CAUTION

Always wear a properly grounded wrist strap whenever any part of WLTC case is open.

The SCSI BUS CABLE is secured to FDD HOLDER by four screws fastening its external connectors. It connects to SCSI PCB ASSY.

- 1 Fit SCSI BUS CABLE into HOLDER.

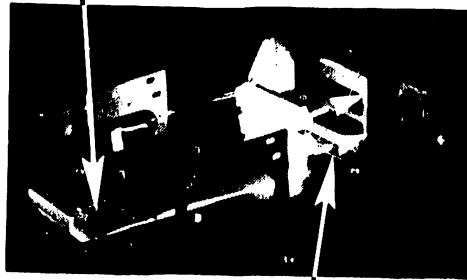

- 3 Install four screws securing external connectors.

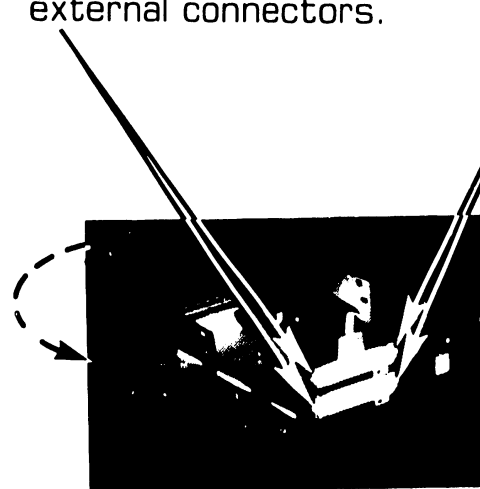

- 4 Reinstall SCSI PCB ASSY (➤ 7.8.4).
- 5 Reinstall FDD (➤ 7.8.3).
- 6 Reinstall POWER PCB ASSY (➤ 7.8.2).
- 7 Reassemble unit (➤ 7.8.1).

- 2 Carefully draw connector "ears" through FDD HOLDER and position connectors.

SECTION

8

ADJUSTMENTS

SECTION 8 CONTENTS

SECTION 8 ADJUSTMENTS

		Page
8.1	TOOLS AND TEST EQUIPMENT	8-1
8.2	ADJUSTING LCD ARM PRESSURE PLATE	8-2

8.1

Tools And Test Equipment

1 Anti-Static Kit 727-0362

Always wear a properly grounded wrist strap whenever any part of Wang LapTop Computer case is open. Discharge any static charge by wearing wrist strap and connecting it to suitable ground *before* handling the WLTC. The wrist strap must be connected to suitable ground, which, in turn, is ultimately connected to building ground. Such suitable ground might be the main chassis of other electronic office equipment, preferably Wang equipment.

2 No other special tools or test equipment are required to repair the WLTC.

8.2

ADJUSTMENTS

Adjusting LCD Arm Pressure Plate (sheet 1 of 2)

CAUTION

Always wear a properly grounded wrist strap whenever any part of WLTC case is open.

Purpose of this adjustment is to ensure that LCD ASSY fits snugly, but not too tightly, into LCD ARMS. Adjustment is correct when LCD ARM PRESSURE LEVERS can be secured easily *and* LCD ASSY cannot be pulled loose by a moderate tug.

CAUTION

Do not overtighten: Turn in ADJUST SCREW *only* 1/4 turn at a time. Excess pressure may split LCD ARMS when securing LCD ARM PRESSURE LEVERS.

- 1 Remove LCD Assy (▶ 7.3.4).
- 2 Turn in ADJUST SCREW to tighten fit.

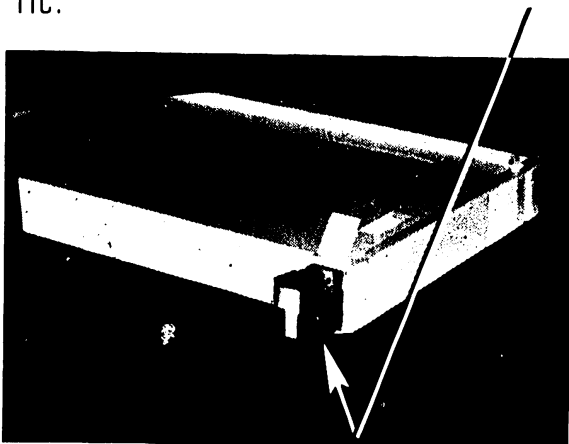

- 3 Reinstall LCD Assy (▶ 7.4.4).

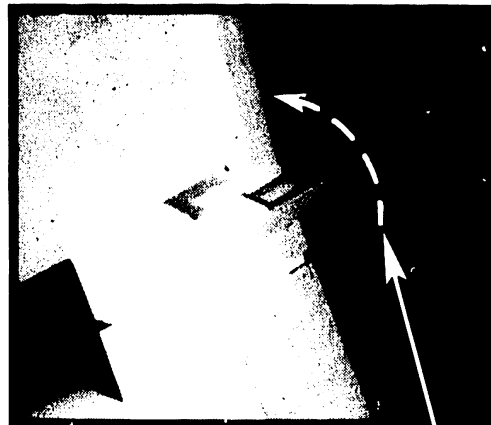
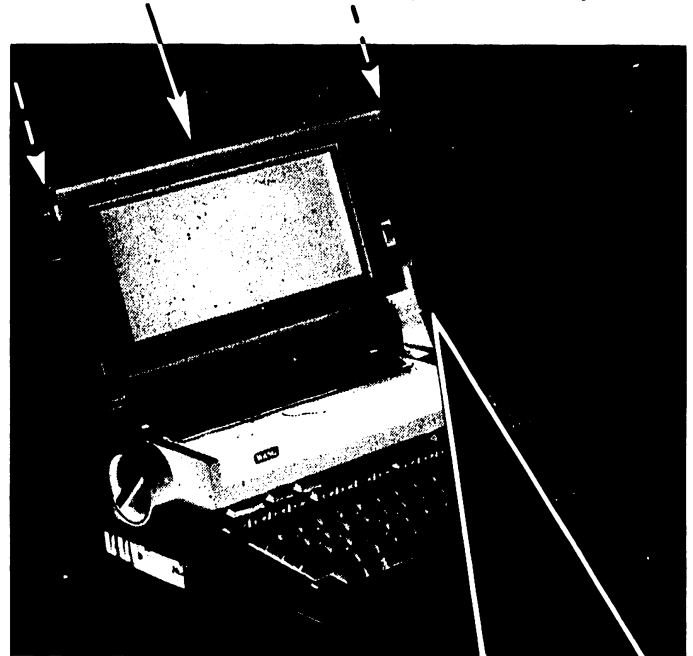

- 4 Test adjustment by closing PRESSURE LEVERS. LEVERS must close easily, without requiring undue force. Readjust, if necessary.

▶ NEXT

8.2

ADJUSTMENTS

Adjusting LCD Arm Pressure Plate (sheet 2 of 2)

CAUTION

Always wear a properly grounded wrist strap whenever any part of WLTC case is open.

- 5 Test adjustment, again, by lifting WLTC by LCD ASSY. Tighten adjustment if LCD ASSY pulls loose.

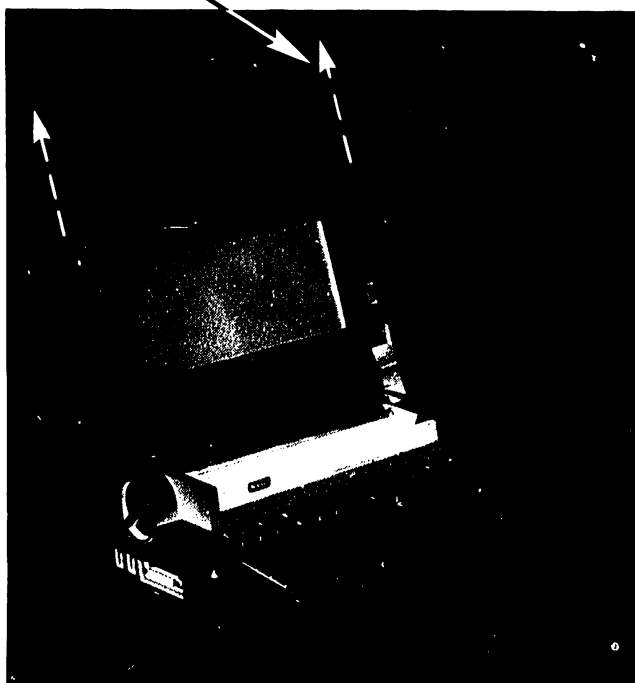

- 6 If necessary, redo adjustment until correct.

● END

SECTION

9

UNPACKING

AND

SETUP

SECTION 9 CONTENTS

SECTION 9 UNPACKING AND SETUP

		Page
9.1	TOOLS AND TEST EQUIPMENT	9-1
9.2	CHECKING SHIPMENT	9-2
9.3	UNPACKING CARTONS.....	9-3
9.4	SET-UP	9-4

9.1 UNPACKING AND SETUP

Tools and Test Equipment

1. Anti-static Kit 727-0362

Always wear a properly grounded wrist strap whenever any part of Wang LapTop Computer case is open. Discharge any static charge by wearing wrist strap and connecting it to suitable ground *before* handling the WLTC.

The wrist strap must be connected to suitable ground, which, in turn, is ultimately connected to building ground. Such suitable ground might be the main chassis of other electronic office equipment, preferably Wang equipment.

2. No other special tools or test equipment are required to install the WLTC.

UNPACKING AND SETUP

9.2 Checking Shipment

A packing slip is attached to one carton and lists the items shipped.

1. Locate packing slip.
2. Ensure packing slip lists all the items ordered.
3. Examine all cartons for signs of damage.
4. Report any missing or damaged items to your local Wang representative.

9.3 UNPACKING AND SETUP

9.3 Unpacking Cartons

The Wang LapTop Computer is packaged in three cartons. An additional corrugated cardboard insert contains any optional hardware, such as numeric keypad or memory expansion module.

1. Open carton labeled "Open This First".
2. Remove:
 - AC ADAPTER
 - PAPER ROLL ATTACHMENT
 - Package containing:
 - Documentation set
 - Function strips
 - Software diskettes
 - installation diskette
 - system software diskettes
 - Printer ribbon cassette
 - Roll of thermal paper
3. Open remaining cartons.

CAUTION

Ensure carrying case is right-side-up: Wang logo is on top and zipper is at the bottom.

4. Remove:
 - Carrying case with WLTC inside
 - FDD (Floppy Disk Drive)
 - AC ADAPTER CABLE
 - SCSI CABLE

9.4 Set-up **UNPACKING AND SETUP**

Installation set-up is briefly summarized below. **►**The Wang LapTop Computer Installation Instructions

CAUTION

Do not remove anti-static bags which protect optional expanded memory and modem PCBs until those PCBs are plugged into MAIN PCB ASSY.

1. Install OPT RAM PCB ASSY and MODEM PCB ASSY, if these options are part of shipment.
►7.4.2 and 7.4.3
 2. Connect NICAD BATT ASSY.
►7.4.6
-

CAUTION

Press RESET if WLTC has been accidentally turned on (date and time menu displayed). WLTC must be off before connecting AC ADAPTER.

3. Connecting AC ADAPTER:
 - a. Plug one half of T-connector from AC ADAPTER into POWER JACK at rear of WLTC.
 - b. Plug 2-prong power plug into wall outlet.
 4. Connect FDD (3.5-inch or 5.25-inch). **►**The Wang Portable Diskette Drive Installation Instructions.
-

SECTION

10

**FUNCTIONAL
DESCRIPTION**

SECTION 10 CONTENTS

SECTION 10 FUNCTIONAL DESCRIPTION

To Be Supplied.

SECTION

11

SPECIFICATIONS

SECTION 11 CONTENTS

SECTION 11 SPECIFICATIONS

		Page
11.1	WLTC CPU	11-1
11.2	FDDs	11-3
11.3	OPTIONS	11-4

SPECIFICATIONS

11.1 WLTC CPU

1. Mechanical

Depth: 11.9 inches (30.2 cm)

Width: 13.9 inches (35.3 cm)

Height: 4.0 inches (10.2 cm)

Weight: 14.25 pounds (6.59 kg)

Weight of accessories:

Carrying Case - 2.0 lbs. (0.91kg)

Accessories Bag - 1.25 lbs. (0.57kg)

ac Adapter - 3.75 lbs. (1.7 kg)

Vibration - 2 g at 10 Hz

Shock - 50 g (10 ms on any axis)

LCD:

Size - 9.5 inches (24.1 cm)

active area

25 rows by 80 columns

Resolution:

320 X 200 bit-mapped in

Industry Standard mode

640 X 200 character or bit-

mapped in Wang or Industry

Standard mode

2. Power Requirements

AC adapter (21 Vdc, 1.6 A):

Domestic: 90 to 130 Vac, 50/60 Hz

UL, CSA approved

International: 220 to 250 Vac

System battery (12 Vdc, 1.2 Ah):
10 sub C-cells

3. Environmental Requirements

Operating:

Temperature Range

50 to 104 F (10 to 40 C)

Humidity Range

15 to 85 percent, noncondensing

Shipping:

Temperature Range

-40 to 140 F (-40 to 60 C)

Humidity Range

5 to 90 percent, noncondensing

Storage:

Temperature Range

0 to 120 F (-18 to 49 C)

4. Winchester Disk Drive (internal)

Disk Size: 3.5 inches

Capacity (formatted): 10 MB

Rotation speed: 2322 r/min + 1.5
percent

Data transfer rate: 3.2 megabits/s

5. Printer

Method: thermal/thermal-transfer
impact, 24 X 1 dot matrix

Direction: unidirectional

Carriage Speed: 45.72 mm/s

SPECIFICATIONS

11.1 WLTC CPU

Carriage movement: 1/360 inch
minimum

Print head life: 5,000,000 characters

Number of copies: one original

Characters per second (cps):
Pica - 18.0 cps
Condensed - 32.4 cps

Characters per inch (cpi):
Pica - 10 cpi
Enlarged - 5 cpi
Condensed - 18 cpi
Enlarged & Condensed--9 cpi

Characters per line (cpl):
Pica - 80 cpl
Enlarged - 40 cpl
Condensed - 132 cpl
Enlarged & Condensed - 72 cpl

Character size:

Pica - 2.258 X 2.399 mm
16 X 17 dots

Condensed - 1.129 X 2.399 mm
16 X 17 dots

Paper Feed:
Method - friction
Speed - 28.2 mm/s
Direction - forward and backward

Line Feed:

Paper Feed Keys - 1/12 inch
Line Space Setting - n/216 inch
default is 1/6 inch

Ribbon:

Type - one-time thermal transfer
Life - 40,000 characters (Pica)
Width - 6.35 mm
Length - 100 m

SPECIFICATIONS

11.2 FDDs

1. 3.5-inch FDD

Depth: 8.25 inches (20.9 cm)

Width: 5.6 inches (14.2 cm)

Height: 2.75 inches (7.0 cm)

Weight (including internal battery):
3.75 pounds (1.7 kg)

Disk size: 3.5 inches

Capacity (formatted): 720 KB,
double-sided double-density

Rotation speed: 300 r/min + 1.5
percent

Data transfer rate--250 kilobits/s

2. 5.25-inch FDD

Depth: 9.9 inches (25.1 cm)

Width: 8.3 inches (21.1 cm)

Height: 3.5 inches (8.9 cm)

Weight: 6.0 pounds (2.7 kg)

Disk Size: 5.25 inches

Capacity (formatted):
360 KB, double-sided double-density

Rotation Speed:
300 r/min + 1.5 percent

Data transfer rate: 250 kilobits/s

SPECIFICATIONS

11.3 Options

1. Internal Modem

Model WLTC-2-1

- Compatible with industry-standard Hayes Command Set
- Compatible with Bell-212A when operating at 1200 bps, asynchronous and synchronous
- Compatible with Bell-103 when operating at 0-300 bps, asynchronous

Model WLTC-2-2

- Compatible with industry-standard Hayes Command Set
- CCITT V.22 bis QAM modulation at 2400 bps, asynchronous and synchronous
- CCITT V.22 PSK modulation at 1200 and 600 bps, asynchronous and synchronous
- Compatible with Bell-212A PSK modulation when operating at 1200 bps, asynchronous and synchronous
- Compatible with Bell-103 FSK modulation when operating at 0-300 bps, asynchronous

2. Optional RAM PCB

Model WLTC-3-1

512-KB memory expansion card

3. Numeric Keypad

Model WLTC-4-1

Depth: 6.25 inches (15.9 cm)

Width: 4.0 inches (10.2 cm)

Height: 0.75 inches (1.9 cm)

Weight: 0.50 pounds (0.23 kg)

4. Acoustic Coupler

Model WLTC-2-3

Depth: 4.0 inches (10.2 cm)

Width: 4.0 inches (10.2 cm)

Height: 3.8 inches (9.6 cm)

Weight: 1.0 pounds (0.5 kg)

5. Suggested Color Monitors

Taxan 630

Taxan 640

Most digital RGBI monitors with horizontal clock of 25 KHz ± 10 percent

SECTION 12
ILLUSTRATED
PARTS

SECTION 12 CONTENTS

SECTION 12 ILLUSTRATED PARTS

Page

12.1	RECOMMENDED SPARES LIST	
12.1.1	WLTC, Base Unit	12-1
12.1.2	Options	12-3
12.1.3	Lower Case Items	12-5
12.1.4	Upper Case Items	12-7
12.1.5	FDD (3.5 in.)	12-13
12.1.6	FDD (5.25 in.)	12-17

12.1

ILLUSTRATED PARTS

Recommended Spares List

12.1.1

WLTC, Base Unit (sheet 1 of 2)

<i>Item</i>	<i>Part Number</i>	<i>Description</i>
1	725-3313	CPU
2	725-3312	AC Adapter, 110V
	725-3327	AC Adapter, 220V

▶NEXT

12.1

ILLUSTRATED PARTS

Recommended Spares List

12.1.1

WLTC, Base Unit (sheet 2 of 2)



◆ END

12.1

ILLUSTRATED PARTS

Recommended Spares List

12.1.2

Options (sheet 1 of 2)

<i>Item</i>	<i>Part Number</i>	<i>Description</i>
1	No Part No.	FDD (3.5 in.)
2	No Part No.	FDD (5.25 in.)
3	725-3315	10 Key Pad Assembly
4	210-8875	Modem PCB Assembly-300/1200 BPS
	725-2863	Modem PCB Assembly-300/1200/2400 BPS
5	725-3333	OPT RAM PCB Assembly

►NEXT

12.1

ILLUSTRATED PARTS

Recommended Spares List

12.1.2

Options (sheet 2 of 2)

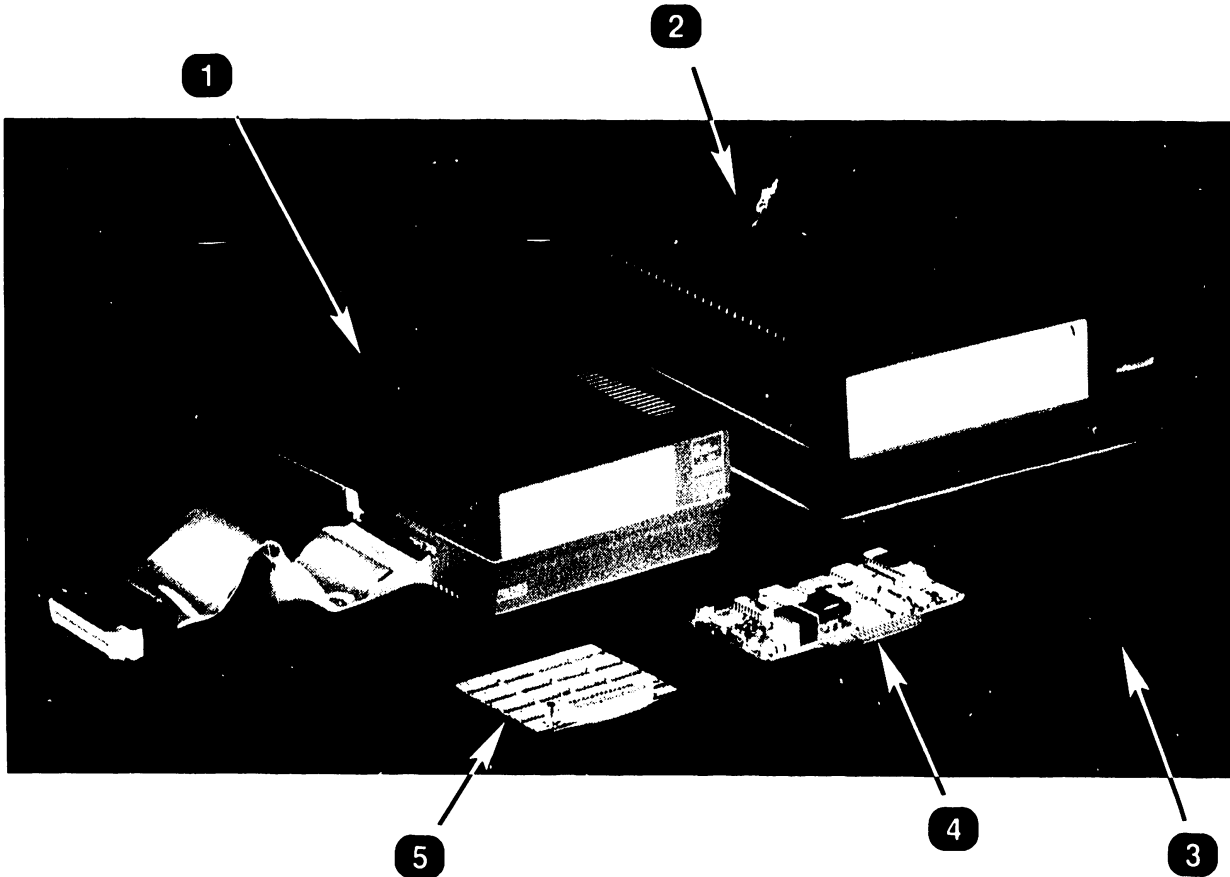

◆ END

12.1

ILLUSTRATED PARTS

Recommended Spares List

12.1.3

Lower Case Items (sheet 1 of 2)

<i>Item</i>	<i>Part Number</i>	<i>Description</i>
1	726-2666	Earth Spring PH
2	726-2388	Blind Sheet
3	726-2389	Reset Button Cover
4	725-3317	NICAD BATT Assembly
5	726-2394	Battery Cover
6	726-2292	STD RAM PCB Assembly
7	726-2381	Sub BATT Assembly
8	726-2291	Power PCB Assembly
9	726-2668	Earth Spring HDD Assembly
10	726-2393	Lower Case
11	726-2290	Main PCB Assembly
12	726-2390	Screw 3x7 (Mounting screws for Main PCB Assy and Power PCB Assy)

▶NEXT

12.1

ILLUSTRATED PARTS

Recommended Spares List

12.1.3

Lower Case Items (sheet 2 of 2)

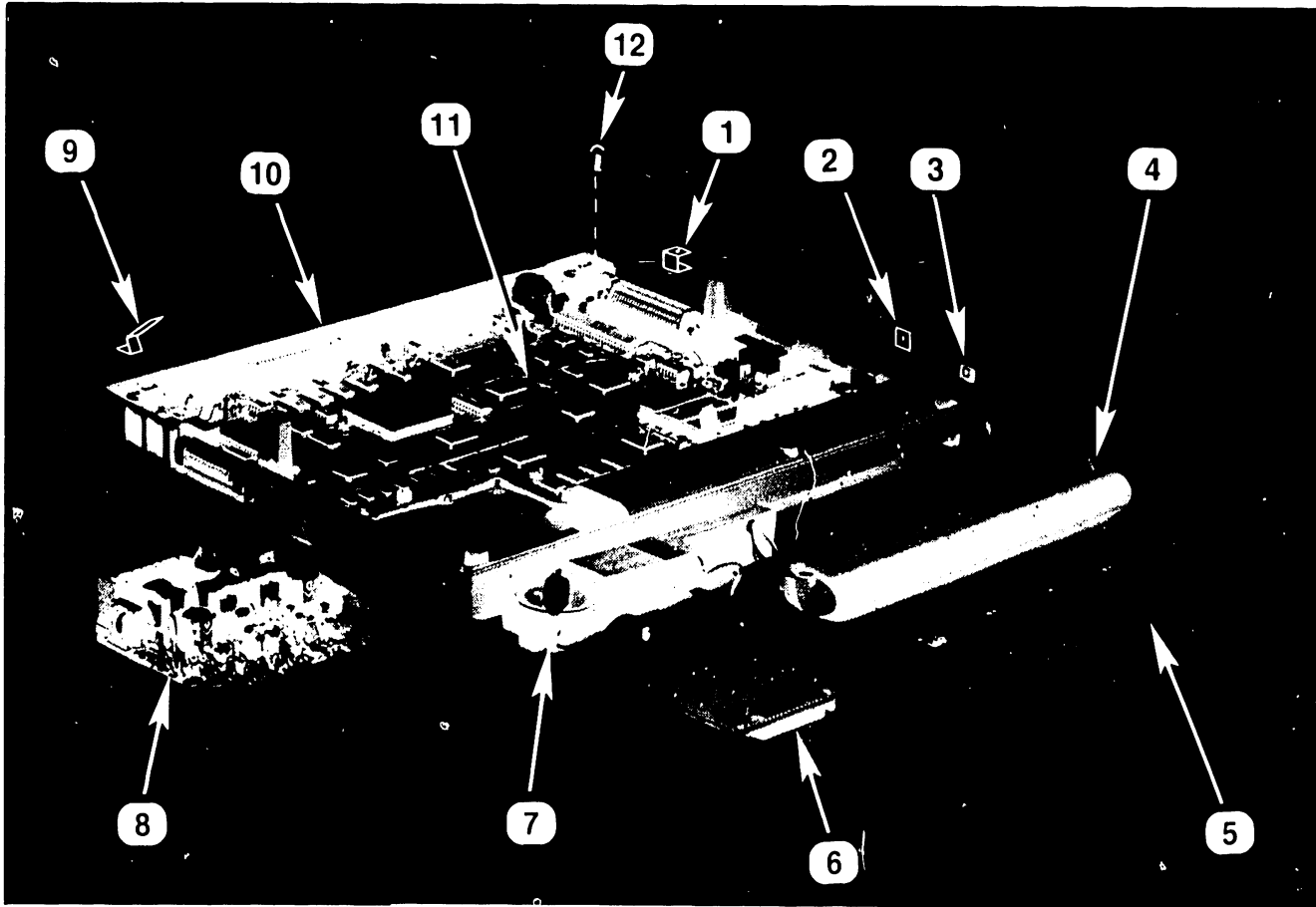

● END

12.1

ILLUSTRATED PARTS

Recommended Spares List

12.1.4

Upper Case Items (sheet 1 of 6)

<i>Item</i>	<i>Part Number</i>	<i>Description</i>
1	726-2296	LCD Assembly
2	726-2396	Arm Cap R
3	726-2385	Cassette Cover Assembly
4	726-2395	Rear Cover
5	726-2294	K/B Full Assembly
6	726-2397	Platen Knob Assembly

▶NEXT

12.1

ILLUSTRATED PARTS

Recommended Spares List

12.1.4

Upper Case Items (sheet 2 of 6)

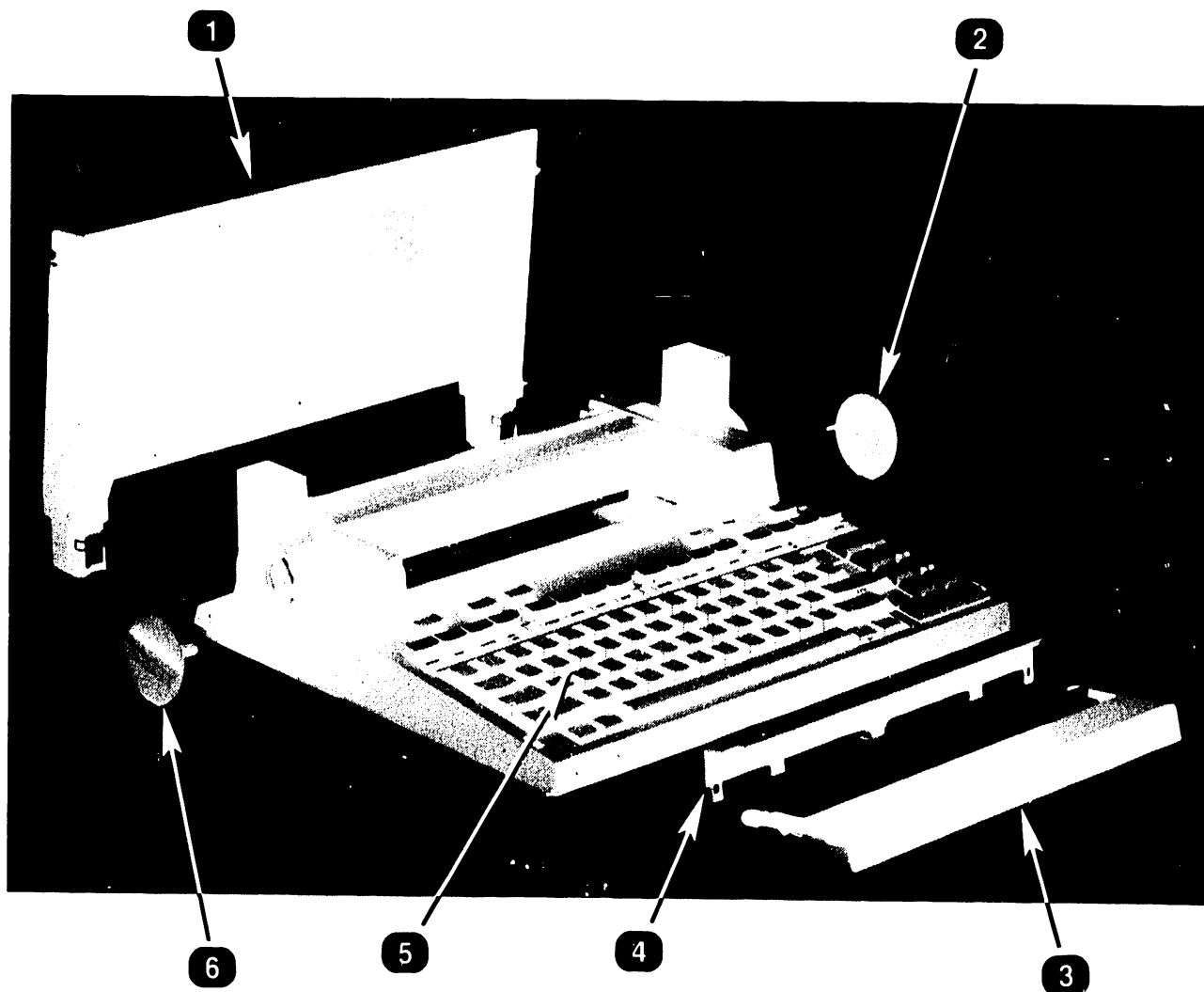

►NEXT

12.1

ILLUSTRATED PARTS

Recommended Spares List

12.1.4

Upper Case Items (sheet 3 of 6)

<i>Item</i>	<i>Part Number</i>	<i>Description</i>
1	See Sheet 5 of 6	
2	726-2667	Earth Spring K/B
3	726-2397	Platen Knob Assy
4	726-2387	Arm FPC Holder
5	726-2396	Arm Cap R

▶NEXT

12.1

ILLUSTRATED PARTS

Recommended Spares List

12.1.4

Upper Case Items (sheet 4 of 6)

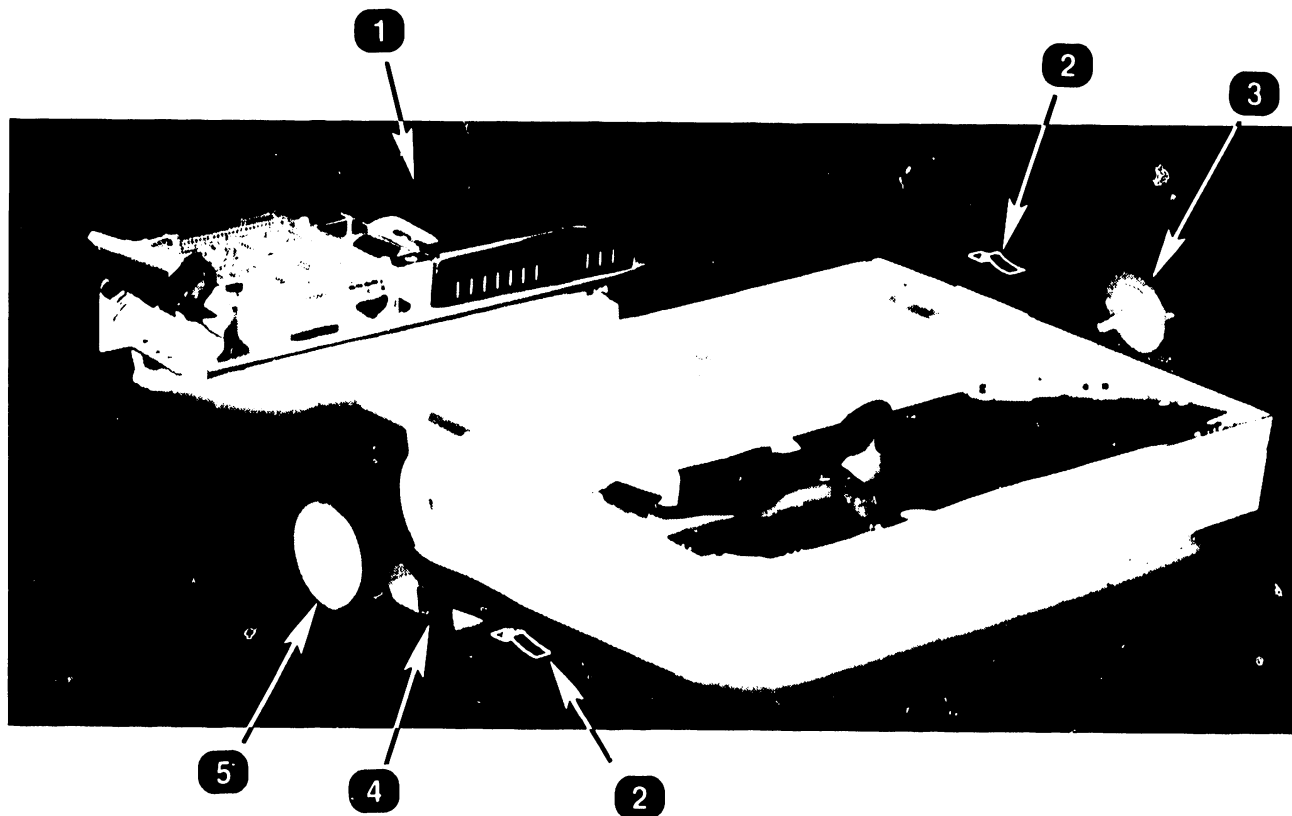

➡ NEXT

12.1

ILLUSTRATED PARTS

Recommended Spares List

12.1.4

Upper Case Items (sheet 5 of 6)

<i>Item</i>	<i>Part Number</i>	<i>Description</i>
1	726-2295	Printer Assembly
2	726-2382	HDD Assembly
3	726-2299	HDD Cable 26
4	726-2380	HDD Power Cable 4 Pin
5	726-2283	HDD PCB (SCSI)
6	726-2298	HDD Cable 50
7	726-2393	Printer PCB Assembly
8	726-2391	Screw 3x5 (5)
9	726-2392	Shoulder Screw (3)
10	726-2384	Flat Washer (for 726-2392)(3)
11	726-2386	Screw 3x7 (3)

▶NEXT

12.1

ILLUSTRATED PARTS

Recommended Spares List

12.1.4

Upper Case Items (sheet 6 of 6)

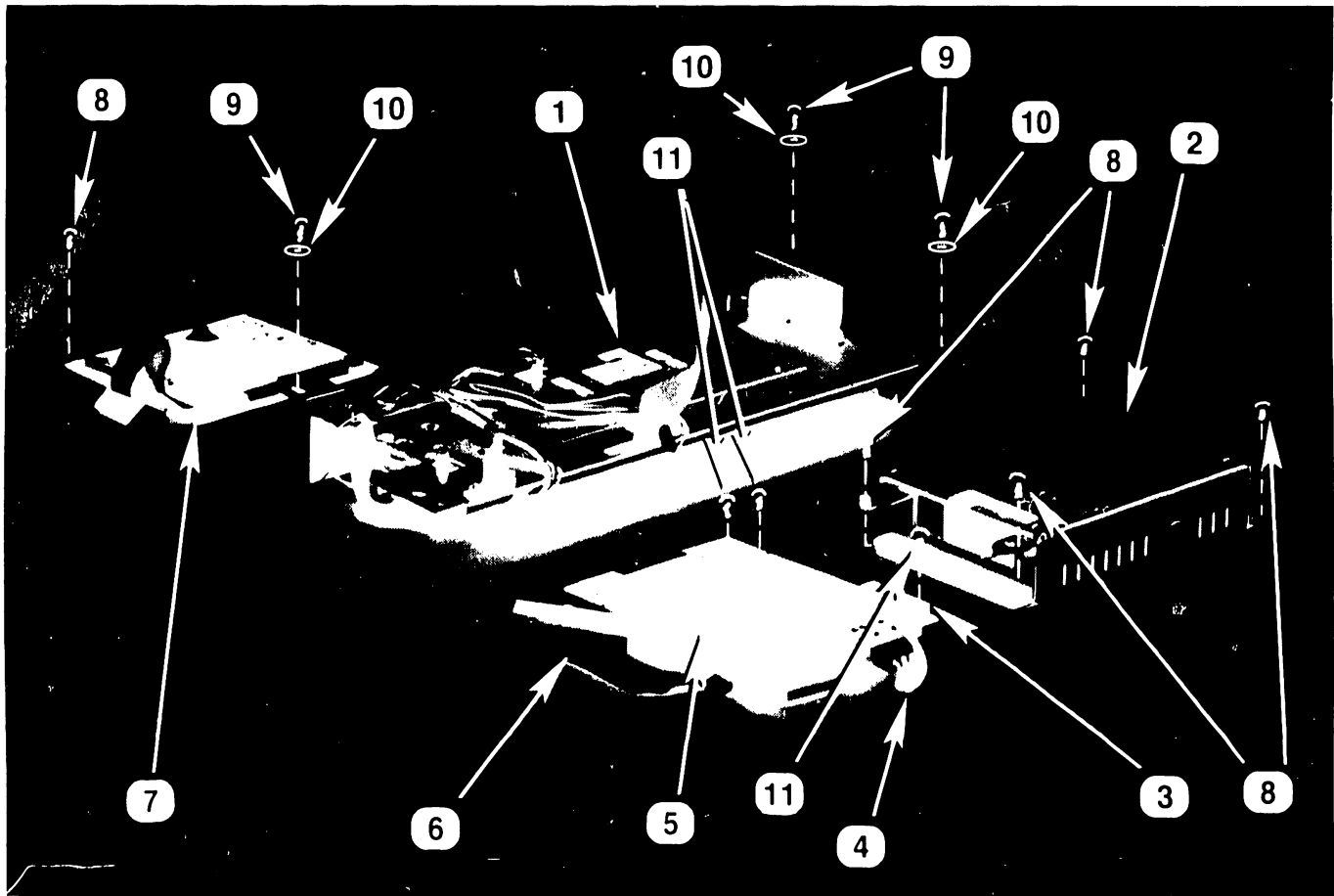

◆ END

12.1

ILLUSTRATED PARTS

Recommended Spares List

12.1.5 FDD (3.5 in.) (sheet 1 of 4)

<i>Item</i>	<i>Part Number</i>	<i>Description</i>
1	See Sheet 3 of 4	
2	726-2599	Battery Lid
3	726-3323	NICAD Battery
4	726-2597	Power Switch Assembly
5	726-2598	Power Jack Assembly
	726-2617	Binding Head Screw (SCSI Cable Clamp)
	726-2614	Binding Head Screw 2.6x4.6 (Shield Assembly)
	726-2616	Binding Head Screw 3x10 (Lower Case)
	726-2615	Binding Head Screw 3x5 (Lower Case)
	726-2612	Binding Head Screw 6x16 (Power PCB)
	726-2611	Flange Head Screw 6x4 (HDD PCB (SCSI))
	726-2610	Flange Screw (FDD Mounting)
	726-2608	Pan Head Screw 3x6 (IF Connector)
	726-2609	Tapping Screw 6x6 (Power Switch)

▶NEXT

12.1

ILLUSTRATED PARTS

Recommended Spares List

12.1.5 FDD (3.5 in.) (sheet 2 of 4)

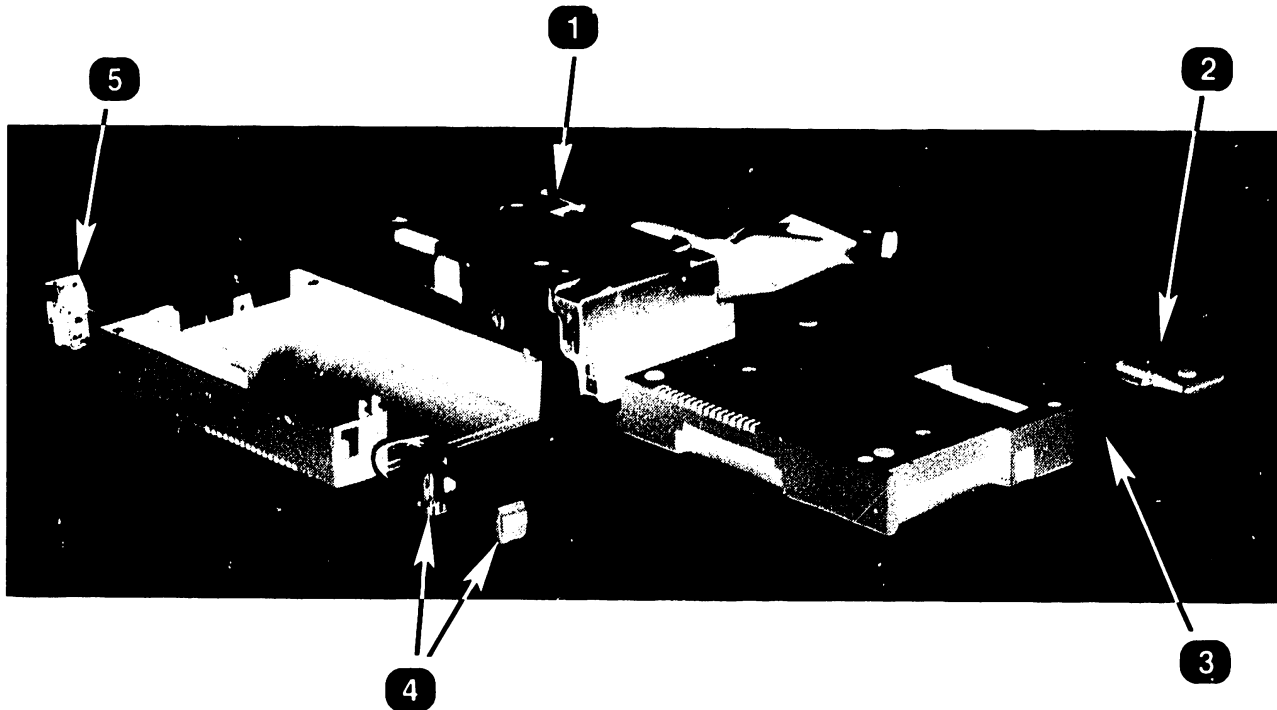

➡ NEXT

12.1

ILLUSTRATED PARTS

Recommended Spares List

12.1.5 FDD (3.5 in.) (sheet 3 of 4)

<i>Item</i>	<i>Part Number</i>	<i>Description</i>
1	726-2596	SCSI Cable Assembly
2	725-3320	SCSI PCB Assembly
3	726-2595	Power PCB Assembly
4	726-2613	FDD IF Cable
5	278-4063	FDD For 113
6	725-3361	Terminator 1 K Ohm

▶NEXT

12.1

ILLUSTRATED PARTS

Recommended Spares List

12.1.5

FDD (3.5 in.) (sheet 4 of 4)

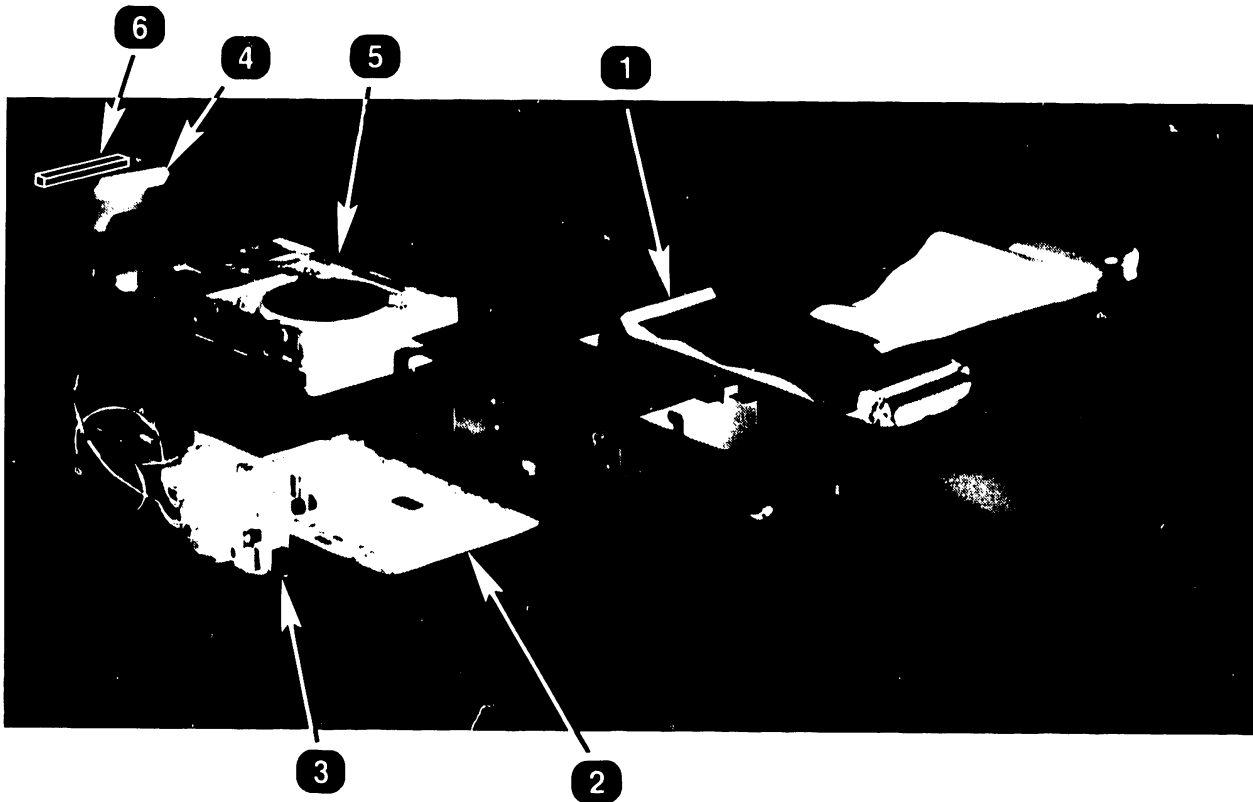

● END

12.1

ILLUSTRATED PARTS

Recommended Spares List

12.1.6

FDD (5.25 in.) (sheet 1 of 2)

<i>Item</i>	<i>Part Number</i>	<i>Description</i>
1	725-2873	Power Supply
2	278-4033	FDD (5.25 Inch)
3	220-3555	SCSI Buss Cable
4	725-3320	SCSI PCB
5	725-3361	Terminator, 1000 ohms
6	220-2484	10-Position Thumb Switch
7	220-2419	AC Power Cable

▶NEXT

12.1

ILLUSTRATED PARTS

Recommended Spares List

12.1.6

FDD (5.25 in.) (sheet 2 of 2)

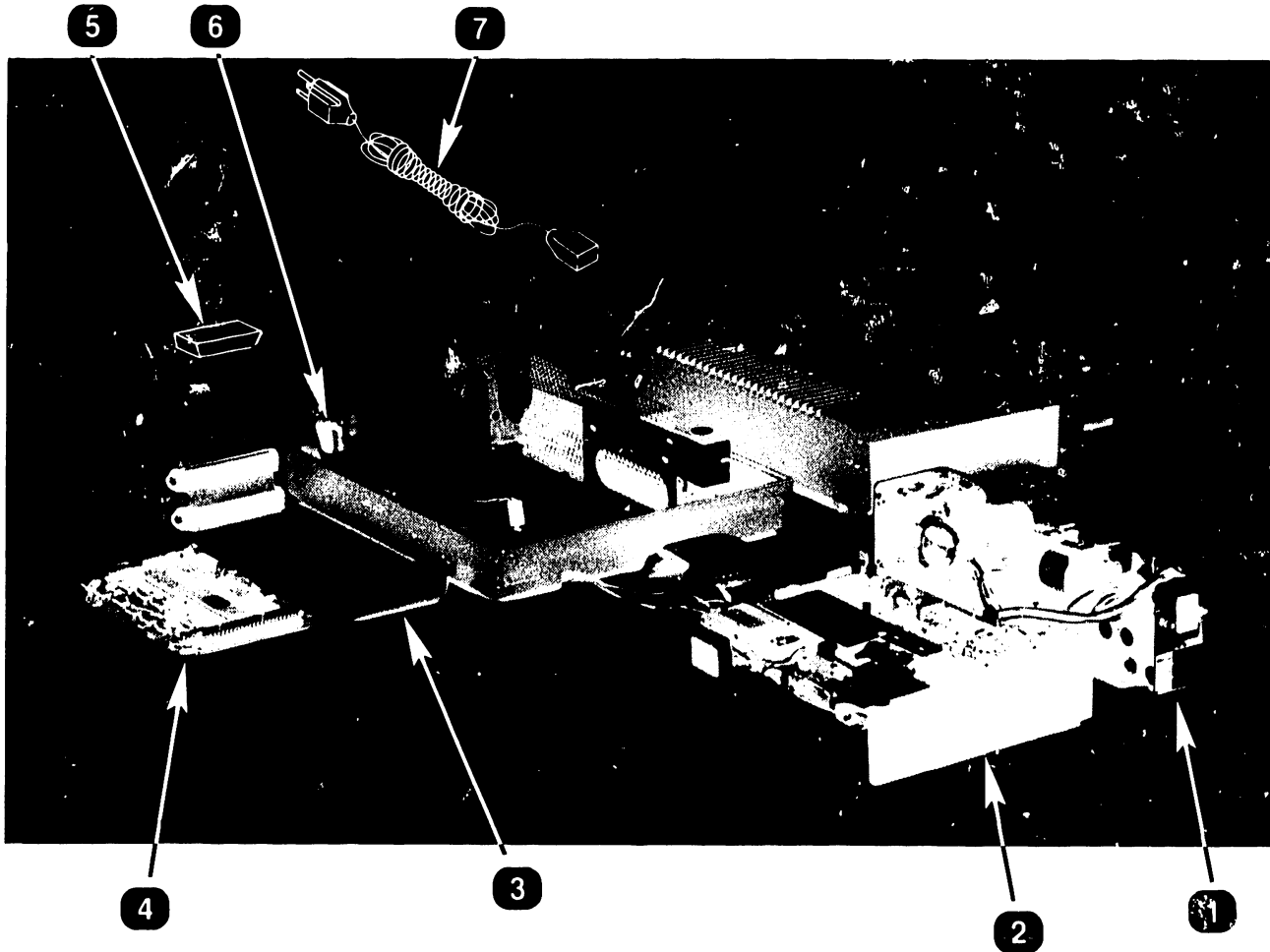

● END



LABORATORIES, INC

ONE INDUSTRIAL AVENUE, LOWELL, MASSACHUSETTS 01851, TEL. (617) 459-5000, TWX 710 343-6769, TELEX 94-7421

PRINTED IN U.S.A.

COMPANY CONFIDENTIAL

END