

XEROX

Xerox
820-II Personal Computer
Operation Manual



This equipment (except the rigid disk drive unit) has been certified to comply with the limits for Class B Computing Device, pursuant to Subpart J of Part 15 of FCC rules. Only peripherals (computer input/output devices, terminals, printers, etc.) certified to comply with the Class B limits may be attached to this computer. Operation with non-certified peripherals is likely to result in interference to radio and TV reception.

The Xerox 820-II generates and uses radio frequency and if not installed and used properly, i.e., in strict accordance with the manufacturer's instructions, may cause interference to radio and television reception. It has been type tested and found to comply with the limits for a Class B Computing Device in accordance with the specifications in Subpart J of Part 15 of FCC rules, which are designed to provide reasonable protection against such interference in a residential installation.

If this equipment does cause interference to radio or television reception, which can be determined by turning the equipment off and on, you are encouraged to try to correct the interference by one or more of the following measures:

- Reorient the receiving antenna.
- Relocate the computer with respect to the receiver.
- Plug the computer into a different outlet so that computer and receiver are on different branch circuits.

If necessary, you may consult Xerox or an experienced radio television technician for additional suggestions. You may find the following booklet prepared by the Federal Communications Commission helpful: "How to Identify and Resolve Radio-TV Interference Problems". This booklet is available from the U.S. Government Printing Office, Washington, D.C. 20402, Stock No. 004-000-00345-4.

The rigid disk drive generates and uses radio frequency energy. If not installed or used properly (in strict accordance with the instructions provided), this equipment may cause interference to radio communications. It has been tested and found to comply with the limits for Class A computing devices pursuant to Subpart J of Part 15 of FCC Rules, which are designed to provide reasonable protection against such interference.

Operation of this equipment in a residential area is likely to cause interference, in which case, the user at his own expense will be required to take whatever measures necessary to correct the interference.

TABLE OF CONTENTS

| | |
|-----------------------------------|-----------|
| 1. Overview | 1 |
| 2. Hardware | 5 |
| System Capabilities | |
| Keyboard | |
| Display | |
| Disk Drives | |
| Printers | |
| 3. Operation | 18 |
| Installation | |
| Getting Started | |
| Using Software | |
| Diagnostic Test | |
| 4. Technical Aspects | 28 |
| Specifications | |
| Memory Map | |
| Serial and Parallel Interface | |
| System Monitor | |
| Appendix | 34 |
| A—Disk Care | |
| B—Software | |
| C—Non-Xerox Printers | |
| D—Glossary of Terms | |

THE 820-II PERSONAL COMPUTER IS THE SOLUTION!

A LOW-COST AFFORDABLE SYSTEM

As your business processing needs increase, so do your requirements for additional equipment.

The 820-II Personal Computer gives you an alternative to single function office equipment. In one complete package you'll find all the capabilities required to effectively automate your office routines.

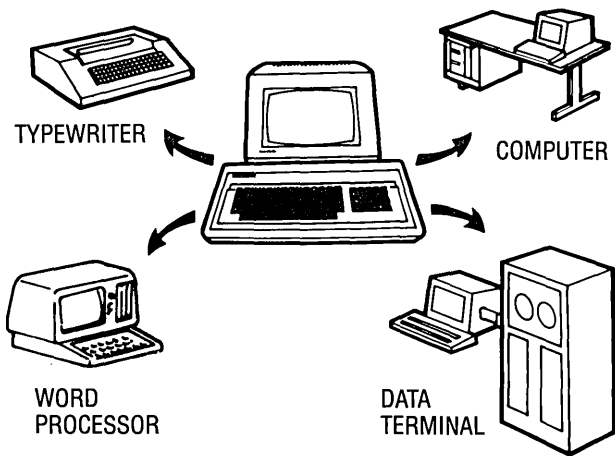
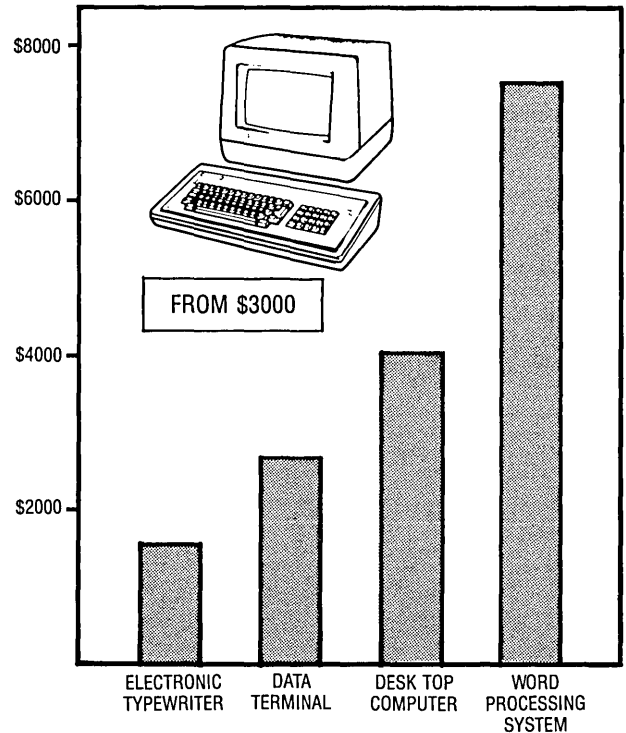

A MULTI-PURPOSE WORK-STATION

The 820-II was designed to be multifunctional. It combines a solid hardware design with a wide selection of software, thus handling not only your word processing and typing needs, but also your information and data processing tasks.

Whether you're a manager or a secretary, the 820-II has productivity increasing features that can work for you!

A VEHICLE FOR PRODUCTIVITY INCREASE

In today's high technology marketplace, your firm's productivity is a direct function of your computing and word processing capability.

LARGE COMPANY . . . WITH LARGE OPERATING BUDGET

THE TRADITIONAL WAY

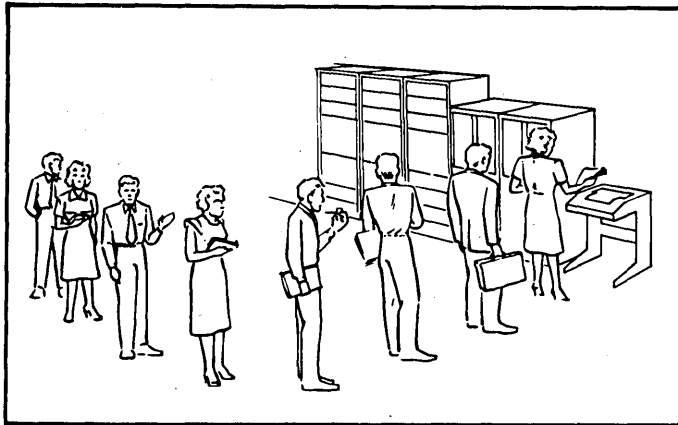

One Computer for
Large Number of Personnel

THE "820-II" WAY

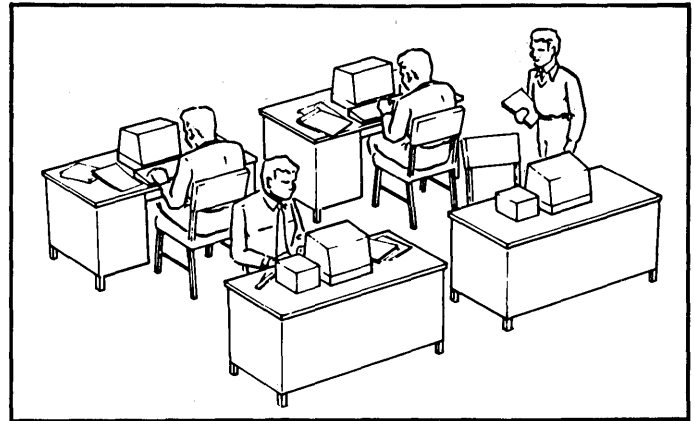

Individual Computer for
Each Decision-Making Employee

SMALL BUSINESS . . . WITH SMALL OPERATING BUDGET

THE TRADITIONAL WAY

| | |
|---|---------------------------|
| Desktop Computer \$4,000 | Word Processor \$7,500 |
|  | |
| Data Terminal \$2,500 | Typewriter \$ 900 |

Each System Is Too
Expensive To Own

THE "820-II" WAY

- Desk Top Computer
- Data Terminal
- Word Processor
- Typewriter

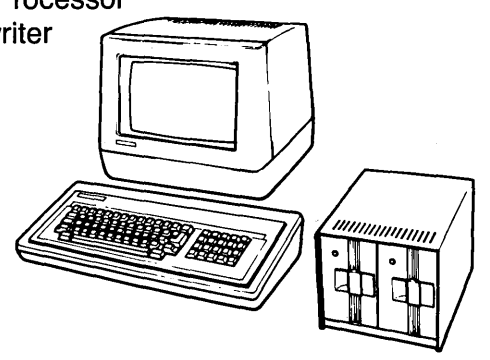

Multi-Function Capability
At an Affordable Price

A GROWTH ORIENTED SYSTEM

EXTENSIVE SOFTWARE LIBRARY AVAILABLE



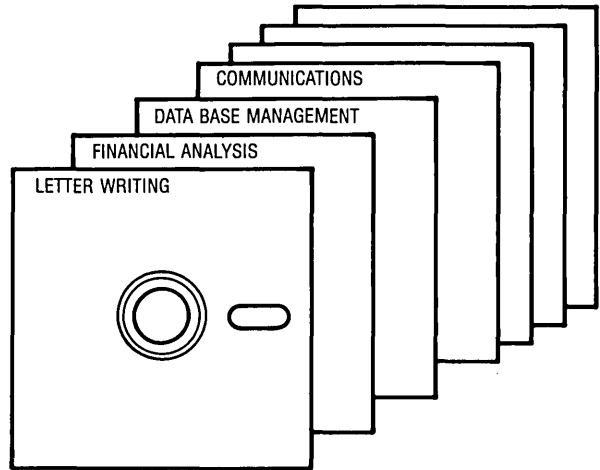



As a desktop computer, the 820-II gives you a cost effective way to automate your daily work routines and manual tasks. The 820-II uses the popular CP/M® 2.2 Operating System which opens the door to a virtual warehouse of software packages. You can purchase software directly from Xerox or from other vendors and software clearing houses. Your sales representative can provide you with specific information.



APPLICATIONS ARE USER ORIENTED

Because the 820-II is a multifunction machine, it can be used by a multitude of people in a variety of ways.

The versatility of the 820-II becomes apparent as you explore the available system features. The inherent system capabilities, coupled with the powerful CP/M® 2.2 Operating System, provide the capability to perform many tasks previously handled only by relatively expensive minicomputers. Thus, anyone associated with the processing of information can find an application and a use for the 820-II.

| | |
|--|---|
| SECRETARIAL  | <ul style="list-style-type: none"> • WORD PROCESSOR • ELECTRONIC TYPEWRITER • TEXT EDITOR |
| FINANCIAL  | <ul style="list-style-type: none"> • ELECTRONIC SPREAD SHEET • AUTOMATED PAYROLL • ACCOUNTS RECEIVABLE |
| ENGINEERING  | <ul style="list-style-type: none"> • ANALYSIS TOOL • DATA TERMINAL • DATA BASE SYSTEMS |
| MANAGEMENT  | <ul style="list-style-type: none"> • AUTOMATED FORECASTS • LONG RANGE PLANNING • EXPENSE ACCOUNTS |
| LAW  | <ul style="list-style-type: none"> • OFFICE BILLING • AUTOMATED FORM PREPARATION • LEGAL DATA BASE |
| ARCHITECTURE  | <ul style="list-style-type: none"> • JOB COSTING • CASH RECEIPTS • CASH DISBURSEMENTS |
| MEDICAL  | <ul style="list-style-type: none"> • AUTOMATED BILLING • GENERAL LEDGER • PATIENT HISTORIES |
| ETC. | <ul style="list-style-type: none"> • • • |

AMAZINGLY VERSATILE

TAILOR THE SYSTEM TO YOUR NEEDS

A choice of five disk drive units and two printers allows you to choose (and pay for) only the capabilities you need. **And**, you don't need to worry about outgrowing your system! The 820-II has been carefully designed to allow you to increase its capabilities by adding additional software, disk storage and internal memory. An expansion slot is also provided in the processor for future customization.

CAPABILITY TO CREATE YOUR OWN SOFTWARE

In addition to the extensive library of CP/M programs, the 820-II has several programming languages available. The variety of available languages allows you to choose the most efficient way to write your own software.

Some of the most common programs written by business people are forms fill-in and customized reports.

Below is a partial list of the 820-II's programming features. Your sales representative can give a more complete listing.

- | | |
|-------------------|---|
| CP/M | All of the features and facilities of the CP/M® 2.2 Operating System are available to you. The CP/M manual provides all the specific details. The implementation of CP/M on the 820-II makes it one of the fastest and most flexible systems available. |
| BASIC | Several versions of BASIC are available. BASIC-80, from Microsoft, may be purchased directly from Xerox. It meets the ANSI subset standard for BASIC and has many features not found in other BASICs. It's available on 5¼" and 8" disks. |
| CBASIC II™ | CBASIC is the Compiler Systems version of BASIC. It's available through Xerox on 5¼" and 8" disks. |

THE 820-II SYSTEM

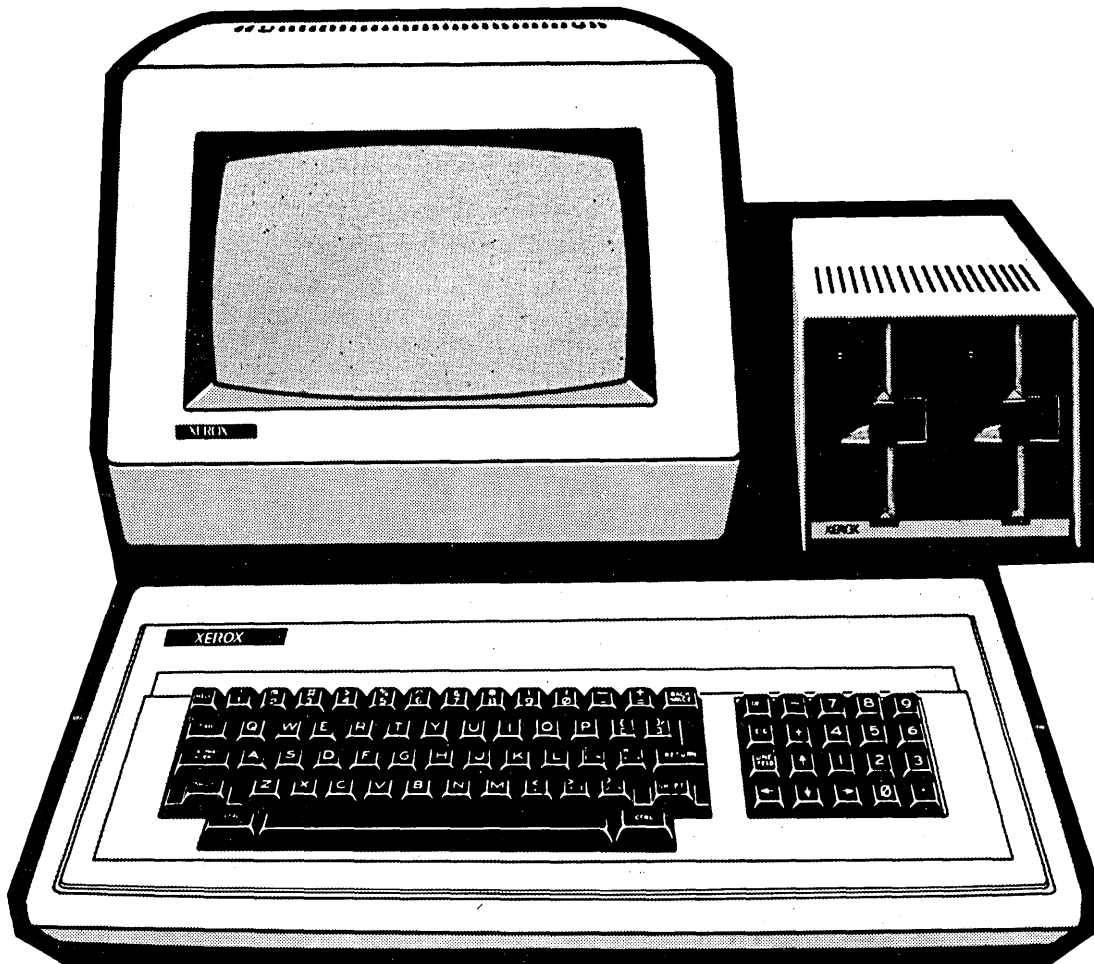

The 820-II system is a collection of four components working in unison. The component structure gives you flexibility in placement and system capability.

- KEYBOARD** The keyboard is used to communicate with the system. The keys are organized in standard typewriter style.
- DISPLAY (CRT)** Similar to a TV screen, the CRT provides clear readable viewing of the material being entered. The display device also houses the computer, which is the heart of the system.
- MEMORY (Disk Drives)** Disk drives allow the fastest and most convenient means for storing large amounts of information.
- PRINTER (Optional)** The printer provides hard copy output of the information on the screen or disk.

HARDWARE CAPABILITIES FOR MOST COMPUTING APPLICATIONS

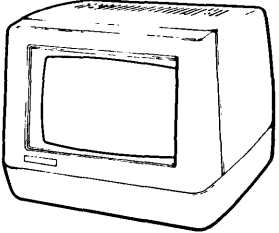
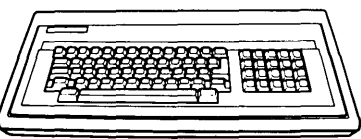
| COMPONENT | DESCRIPTION/CAPACITY | TECHNICAL DESCRIPTION |
|---|--|--|
|  | <p style="text-align: center;">DISPLAY SCREEN</p> <ul style="list-style-type: none"> • 24 line display • 80 characters per line • Flicker free screen • White characters on black screen • Exceeds industry standards • Brightness adjustment | <p style="text-align: center;">CRT</p> <ul style="list-style-type: none"> • 7 × 10 dot matrix for characters • Software selectable character attributes <ul style="list-style-type: none"> • Inverse video • Blinking • Low intensity • Graphics with 4 × 4 Pixel resolution • High speed character display |
| | <p style="text-align: center;">PROCESSOR</p> | <ul style="list-style-type: none"> • Single board Z80A[®] Microprocessor • 4 Mhz clock • 64K RAM, 6K ROM • Softloaded • 820-II system Bus access • 2K ROM or RAM expansion capacity • 32K RAM expansion capability via system Bus • Dual parallel ports • Dual serial ports |
|  | <p style="text-align: center;">KEYBOARD</p> <ul style="list-style-type: none"> • Standard typewriter key layout • 10 key numeric pad • Automatic repeat of most common characters | <p style="text-align: center;">DATA ENTRY CONSOLE</p> <ul style="list-style-type: none"> • Standard 96 character ASCII keyboard • 4 key cursor control • Alpha shift lock • Erasing backspace key • 32 software definable keys |

Z80A is a trademark of Zilog, Inc., with whom the publisher is not associated.

DISK DRIVE OPTIONS

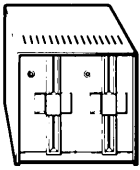
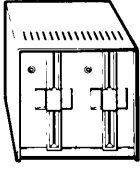
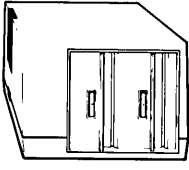
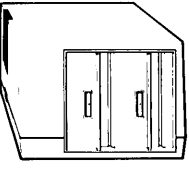
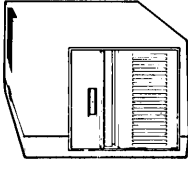
| COMPONENT | DATA STORAGE CAPACITY | DISK PARAMETERS | | |
|---|--|--|--|---|
| 5¼" Single Sided Dual Floppy Disk Drives  | Single Density Disk holds 40 pages Double Density Disk holds 70 pages | SINGLE DENSITY 128 18 40 3 81K | DOUBLE DENSITY 256 17 40 3 155K | Bytes/Sector Sectors/Track Tracks/Disk #Tracks reserved for system use Disk capacity for user |
| 5¼" Double Sided Dual Floppy Disk Drives  | Single Density Disk holds 80 pages Double Density Disk holds 140 pages | SINGLE DENSITY 128 18 80 3 172K | DOUBLE DENSITY 256 17 80 3 322K | Bytes/Sector Sectors/Track Tracks/Disk #Tracks reserved for system use Disk capacity for user |
| 8" Single Sided Dual Floppy Disk Drives  | Single Density Disk holds 120 pages Double Density Disk holds 240 pages | SINGLE DENSITY 128 26 77 2 241K | DOUBLE DENSITY 256 26 77 2 482K | Bytes/Sector Sectors/Track Tracks/Disk #Tracks reserved for system use Disk capacity for user |
| 8" Double Sided Dual Floppy Disk Drives  | Single Density Disk holds 240 pages Double Density Disk holds 480 pages | SINGLE DENSITY 128 26 154 2 490K | DOUBLE DENSITY 256 26 154 2 980K | Bytes/Sector Sectors/Track Tracks/Disk #Tracks reserved for system use Disk capacity for user |
| 8" Rigid Disk Drive  | The Rigid Disk holds up to 4000 pages of material. A Double Sided 8" Floppy Disk Drive is provided with the 8" fixed disc drive. | 256 32 1024 8.19 | Rigid Disk Parameters Bytes/Sector Sectors/Track Tracks/Drive M-Byte Usable Capacity | Double Sided 8" Floppy Disk Drive provided for back-up and transfer |

Each **K** of disk capacity is equal to 1024 characters (bytes).
 Each **M-Byte** of disk capacity is equal to 1,024,000 characters.

PRINTER OPTIONS

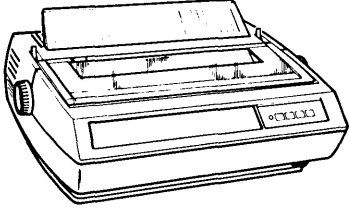
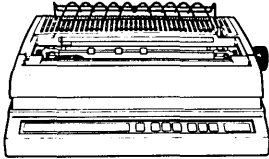
| PRINTER | DESCRIPTION/CAPACITY | TECHNICAL DESCRIPTION |
|---|---|--|
| <p>Xerox 20 CPS printer</p>  | <ul style="list-style-type: none"> • 10, 12 or 15 pitch • 25 characters per second print speed • Self homing printwheel • "Drop-In" print wheel for easy print wheel changes • Interchangeable print wheels • Interchangeable ribbons | <ul style="list-style-type: none"> • Bidirectional printing • 13 inch line width • Daisy wheel print element • 98 character print wheel • Self test diagnostic print • Graphics capability |
| <p>Xerox 40 CPS printer</p>  | <ul style="list-style-type: none"> • 10, 12 or 15 pitch • 40 characters per second print speed • Interchangeable print wheels • Interchangeable ribbons | <ul style="list-style-type: none"> • Bidirectional printing • 13 inch line width • Daisy wheel print element • Choice of tractor or friction feed • Graphics capability • 98 character character set |

*P.S. is optional

A TECHNICAL VIEW

GENERAL

The modular design of the 820-II system enhances the flexibility provided by the CP/M Operating System. The combination of operations provided by the system makes it one of the most adaptable on the market. This flexibility allows the system to be tailored to the needs of each user.

PROCESSOR

The processor is softloaded and uses a Z80-A based microprocessor operating on a 4 megahertz clock, with 64K RAM and 6K ROM memory. The system monitor controls the essential functions of initializing and controlling all system input/output resources, and also provides commands that can be used to assist in programming. (Details on page 32.)

Three undedicated ports are standard on the 820-II: two serial ports are located at the back of the display unit, and an additional dual parallel port is located inside the display unit. These allow printers, communication devices and other peripheral equipment to be interfaced with the system. (Details on page 30 and 31.)

RANDOM ACCESS MEMORY (RAM)

The 820-II system comes complete with 64K RAM. Up to 56K is user definable resulting in a great range of possible applications, from writing a letter to complex scientific calculations. (Details on page 29.)

VIDEO DISPLAY

The 24 line, 80 character display exceeds industry standards for desk top computers, and equals industry standards for small word processing systems. Easy viewing of the 7 × 10 dot matrix white on black characters is enhanced by an adjustable brightness and high quality flicker free display screen. A 4 × 4 pixel resolution graphics capability allows graphics displays.

KEYBOARD

The Xerox 820-II uses a standard 96 character ASCII keyboard. Additional keys are conveniently located to the right of the keyboard. A cursor control provides easy access to any point on the screen. A 10 key numeric key pad is included for convenience and speed in typing statistical material. The 820-II provides for 32 of the keys to be software definable.

DISK DRIVES

The choice of five disk drive options allows you to configure the system to your needs. The 5¼" Dual Floppy Disk Drives can store up to 81K of typed material per side at single density, or twice that at double density. The 8" Dual Floppy Disk Drives can store 241K of typed material per side at single density, or twice that at double density.

The floppy disks are soft sectored and when initialized will have 40 tracks per side on the 5¼" disk and 77 tracks per disk on the 8" disk. For large amounts of data storage, the 8" rigid disk drive offers 8.2 M-bytes of usable storage, with a double sided floppy 8" disk for back up and data portability.

THE 820-II KEYBOARD CONVENIENT BY DESIGN

The 820-II keyboard has been designed for operator convenience. The keyboard is divided into two sections, a standard typewriter style section, and a special functions section.



The standard typewriter keyboard allows those with previous typing experience to rapidly become familiar with the 820-II system. Standard typing key functions are maintained (space, return, etc.) while other keys are enhanced or added to provide access to special features.



The HELP key is a unique feature of the 820-II system, and its appearance on the keyboard demonstrates Xerox's commitment to making this a truly "friendly" system. Pressing the HELP key tells the 820-II word processor that you would like more information.



A TAB key is provided to allow easy formatting of documents and tables.



The ALPHA LOCK key locks only the alphabetical keys thus allowing you to type upper case letters and numbers at the same time.



Type in a wrong character? Just press BACKSPACE and it's gone! Then press the desired character.



The CTRL keys located on either side of the space bar allow almost every key on the board to have a second or even a third meaning. The CTRL key is used in conjunction with the alphabetic keys to input standard ASCII codes.

SPECIAL FUNCTION KEYS

The special function key pad to the right of the standard keyboard provides additional keys for special applications, without cluttering up the standard typewriter layout.

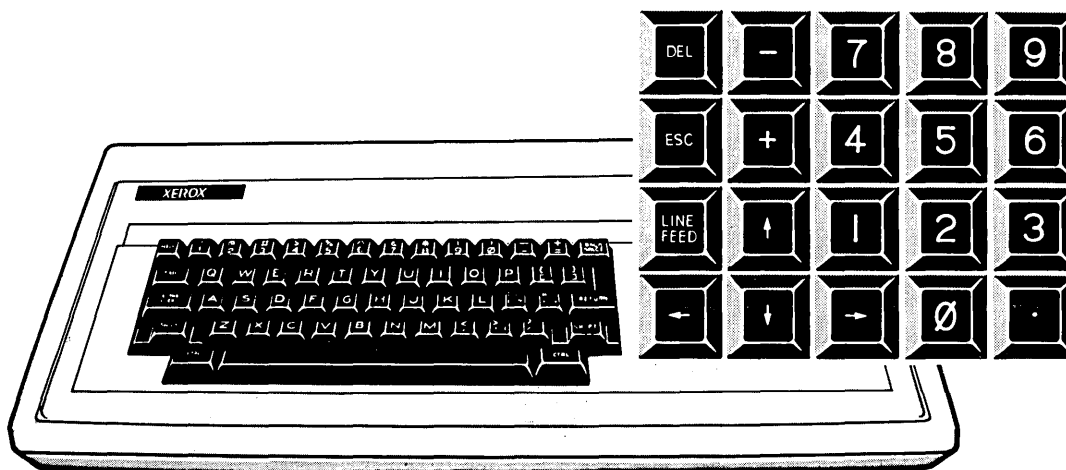

Several special function keys have been grouped in this section for your convenience.



Similar to the backspace key in nature, the DELeTe key erases while moving the cursor to the right. This feature makes corrections in the word processor mode very simple.



The ESCape key is used for sending special commands to the system in both the word processor and CP/M modes.



The LINE FEED key is used to advance the paper without typing a carrier return. It also performs specific functions in some programming languages.



These keys are primarily used with the numeric key pad while entering statistical data. Many accounting packages allow you to use these keys as debit and credit keys.

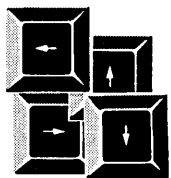

Cursor control keys allow the cursor to be positioned at any point on the display screen, so you can go directly to the point at which a revision is to be made.

FLICKER FREE DISPLAY

The quality flicker free screen selected for the 820-II provides easy viewing for the operator. The 24 line, 80 character display is equal to the industry standard for low cost word processors, and exceeds the industry standards for desk top computers. The display unit for the XEROX 820-II also contains the processor for the system which is softloaded and uses the Z80A based microprocessor with 64K RAM memory and 6K ROM.

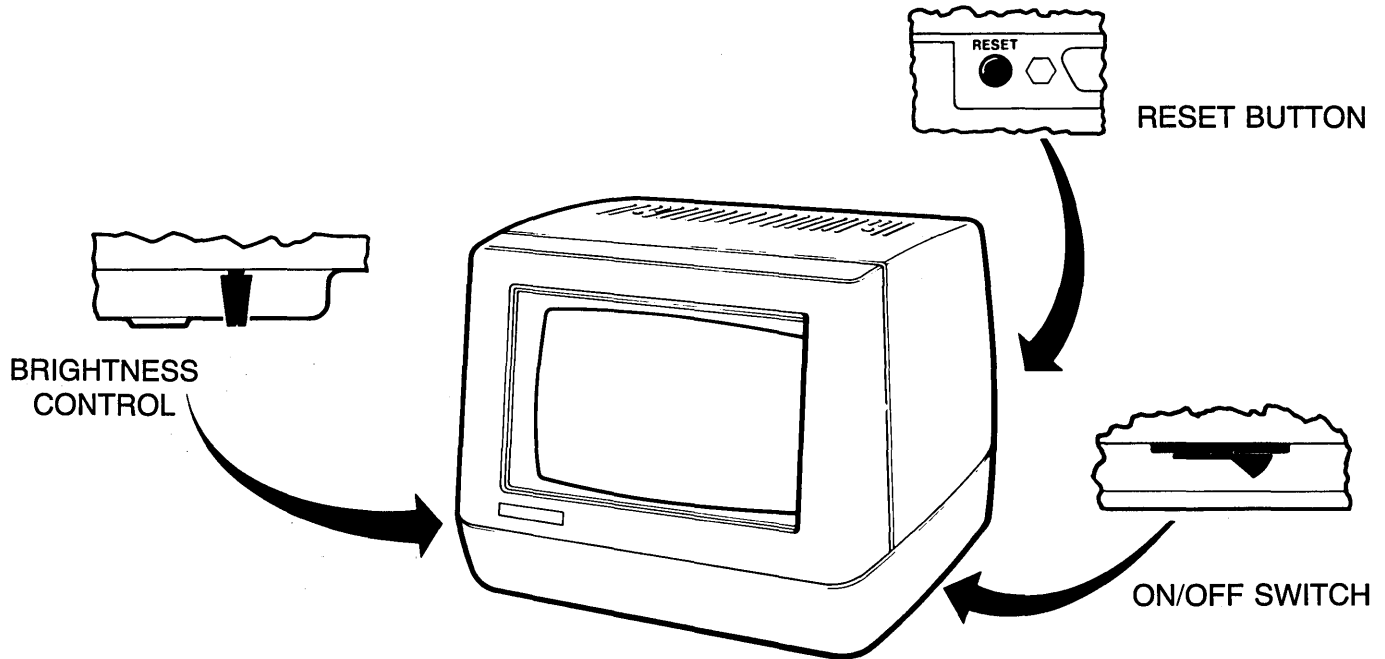

ON/OFF SWITCH

Conveniently located out of the way under the edge of the right side panel, this switch controls power for the display and the central processor. Its location prevents accidental power turn off.

BRIGHTNESS CONTROL

The intensity of the display can be adjusted by the brightness control located under the edge of the left side panel. The control allows you to adjust screen intensity for maximum clarity and comfort.

RESET BUTTON

The reset button, positioned at the rear of the unit is used for reinitializing the softloaded operating system when changing operating modes. Pressing this button tells the 820-II you want to start over (boot).

VERSATILE INPUT/OUTPUT PORTS

The standard 820-II system is equipped with six ports for input and output. Four of the ports are located on the back of the display unit, as shown below. Two of the four ports are used for the standard keyboard and disk drive system components. The fifth and sixth ports are located inside the display unit. (Detailed information on port assignments is given on pages 30 and 31.)

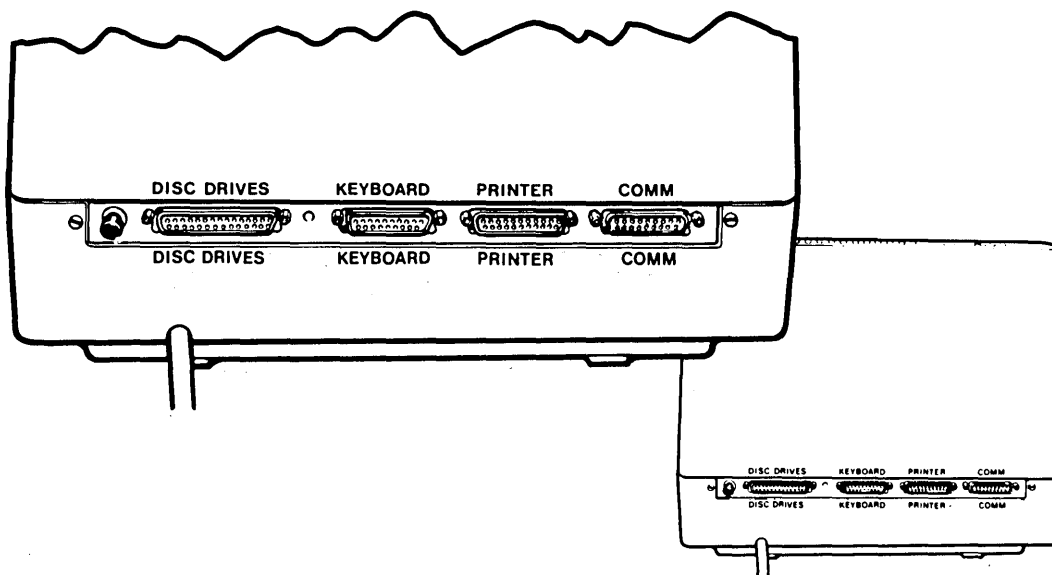

- | | |
|-----------------------|---|
| DISK DRIVE | Used for connection of either the 8" or the 5 $\frac{1}{4}$ " Dual Floppy disk drives, or the 8" Rigid Disk Drive. |
| KEYBOARD | Used for connection of the keyboard, which is where data is input. |
| PRINTER | A serial printer can be connected to this standard RS-232 port. |
| COMM | This port can be used for standard RS-232 communications input/output via a modem. |
| PARALLEL PORTS | The dual parallel port inside the display cabinet is provided for the convenience of users who wish to use a parallel printer or other parallel input/output devices. |
| EXPANSION SLOT | The expansion slot inside the display cabinet provides all of the Z80-A control signals for connection to custom devices for future expansion. |

CHOICE OF DISK DRIVES

The 820-II system comes optionally configured with 5¼" or 8" Dual Floppy, or 8" Rigid Disk Drives. The disk drives offer high data storage capacity, fast data retrieval, and allow data to be accessed in random order. (See page 17 for more information.)

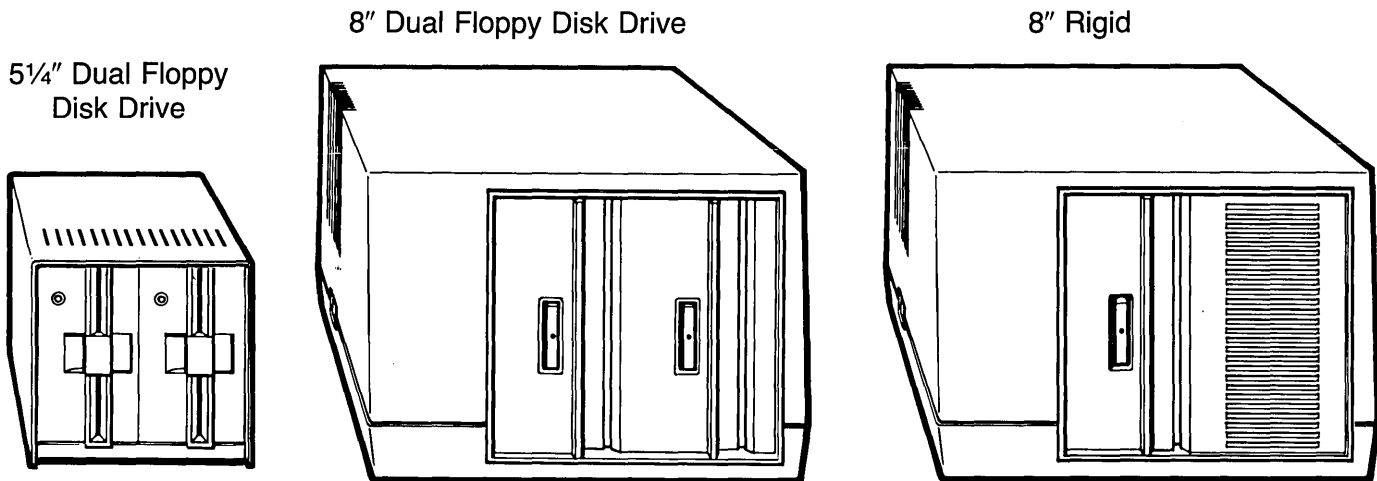

The floppy disk drives are very similar in operation, but differ in physical appearance. The following paragraphs describe how disks are inserted into the drives.

- The 5¼" drive is opened by pulling on the left edge of the latch which is over the drive opening. Once a disk is inserted into the drive, the latch is closed by pushing the left side of the latch until it clicks into place.
- The 8" floppy disk drive is opened by pressing on the oblong button beside the disk door. There is a small red light on the oblong button. To close the door, pull the door to the left until it latches. This procedure is the same for the 8" floppy disk drive which accompanies the 8" rigid disk drive.

When purchasing disks, specify:

5¼" 40 track, soft sectored floppy disk, double density certified

8" 77 track, soft sectored floppy disk, double density certified

If your 820-II disk drive is double-sided, be sure you purchase disks that are **certified** for use in double-sided drives.

FLOPPY DISK STORAGE

The disks are similar in looks and operation to a phonograph record. They are thin and flexible (hence the name Floppy Disks) and are sealed in a stiff paper jacket. The paper jacket covering the disks permit them to be handled with relatively few precautions.

The disks have a write protect tape which can be used to protect against accidental loss of data by overwriting.

The disks are placed in the disk drives, and as information is to be stored or retrieved, they are rotated at high speed. A read/write head (similar to a tape recorder) is moved radially along the head access slot, and can be positioned over any portion of the rotating disk.

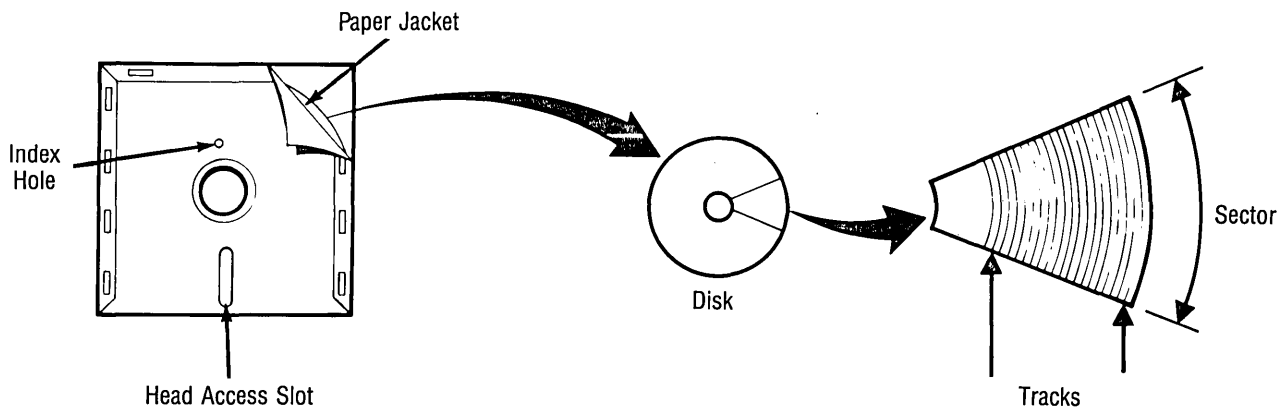
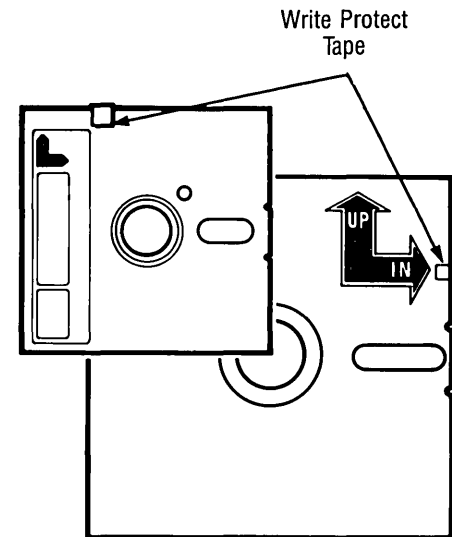

Before the 820-II can use a disk, it must format (initialize) it. The format of the disk allows the 820-II to quickly find and retrieve data from the disk.

When a disk is formatted (initialized), it is partitioned into tracks as illustrated above. Each track is divided into pie shaped wedges, called sectors. This arrangement allows each segment of the disk to be referred to by sector and track. Just like the needle and tone arm of a phonograph turntable, the read/write head can be placed over any track, without having to read (play) intermediate tracks. This random access feature allows rapid access to the data stored on the disk.

Double sided disk drives allow information to be stored on both sides of the disk, just like the two sides of a phonograph record.

Double density disk storage refers to a means by which the drive may store up to twice the information on the same amount of space on a disk.

RIGID DISK STORAGE

A rigid disk can store much larger volumes of information than floppy disks. And physical structure and speed of the rigid disk gives you significantly faster data transfer rates.

The recording of data onto and retrieval of information from a rigid disk is very similar to the process for a floppy disk. The main differences are that the rigid disk is made up of two hard surface platters and has four read/write heads—one for each side of the two platters, as shown in the illustration to the right.

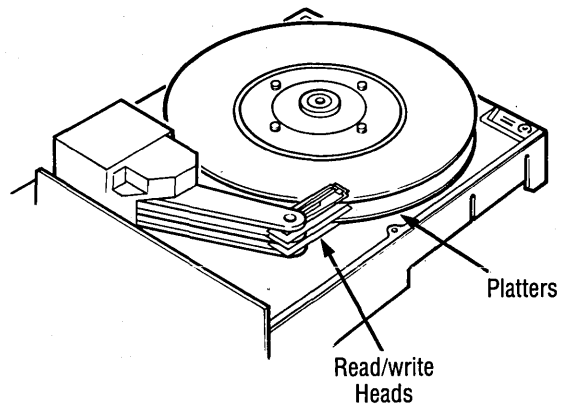

An 8" floppy disk drive is included with the rigid disk drive unit to provide compatibility (read a disk from another 820-II and read software programs purchased on floppy disks). In addition, the 8" floppy disk can be used to make back up copies of the information stored on the rigid to guard against accidental data loss.

When the rigid disk is initialized (formatted), it is divided into sectors and tracks much like the floppy disk. Each platter of the rigid disk will have 256 tracks and each track will have 32 sectors. Each of the sectors can hold 256 characters, so the entire disk can hold over 8 million characters.

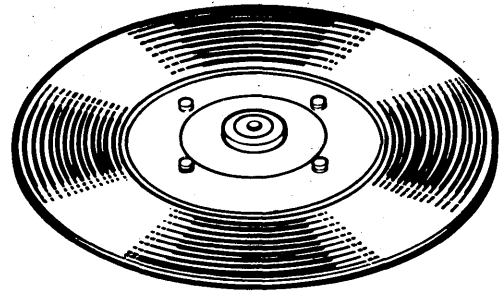

You could use the disk as one big 8 million character disk. Or you could divide the disk into segments so that you can store letters in one segment, a lengthy data base in another segment, all your programs in a third, etc.

The 820-II will automatically divide the disk into four segments (called partitions) containing 4 million characters, 2 million characters and two segments of 1 million characters each. If this partitioning does not meet your needs (perhaps you have a data base larger than 4 million characters), you can change the partitions using the CONFIGUR program provided by Xerox. See your Reference Manual for details.

The four positions are referred to as E, F, G and H.

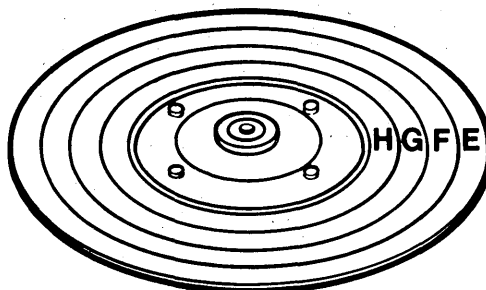

WHICH DISK DRIVE DO I NEED?

The choice of disk drive which is best for you depends upon your data storage needs. With a smaller capacity disk drive, you will have to change disks more often than with a larger capacity drive. If you envision needing storage for small blocks of data at a time (short letters/reports or programs), you might find the small capacity disk convenient.

If you have large blocks of data to store (either one large block, or many related small blocks), the need to change disks to access various portions of the data soon becomes inconvenient. Medium to high capacity disks will be more practical.

For the case where numerous users are sharing the same machine, medium sized disks allow the convenience of moderate data storage capacity while letting each person keep track of his own disks.

If you are handling very large amounts of data, want FAST access, or would just like the convenience of not having to find the proper disk for each application, the rigid disk will allow you to store vast amounts of information, and access any of it without having to find and insert another disk.

Compare your projected usage with the chart below to determine your disk drive needs. Hint: You might as well double your usage figure, you'll find twice as many uses for your 820-II as you had thought.

| | LARGEST SINGLE BLOCK OF INFORMATION (Pages)* |
|---|---|
| 5¼" Single Sided Drive (Double Density) | 70 |
| 5¼" Double Sided Drive (Double Density) | 140 |
| 8" Single Sided Drive (Double Density) | 240 |
| 8" Double Sided Drive (Double Density) | 480 |
| 8" Rigid Disk Drive | 4,000 |

*One page equals approximately 2,000 characters (bytes).

USING THE 820-II

The 820-II Personal Computer has been designed for ease of installation and quick and efficient operation. The capabilities offered by the system are accessible through simple commands. Once the system is in operation, you can change software options by pressing the RESET button and inserting the appropriate disk.

The basic areas of operation (listed below) are discussed in this manual. Specific instructions for different software packages are provided in the manuals supplied with each package.

- INSTALLATION** The individual plug-in system components are easily interconnected. Installing the 820-II is less difficult than installing many of today's component stereo systems.
- DIAGNOSTICS** You can quickly verify that the system has been installed correctly by using the Diagnostic Exerciser Disk. Xerox provides this disk at no additional charge. See your CP/M or Word Processing Reference Manual for details.
- MODE SELECTION** The 820-II offers several operating modes for different kinds of tasks, e.g., word processing is one mode, typewriter is another, CP/M another, etc. These operating modes make the 820-II one of the most versatile pieces of equipment in today's office products field.

INSTALLATION IS AS EASY AS 1, 2, 3

1. Plug components into back of screen.

Be sure to turn the plugs so that the larger side of the pin ring is up before you plug them in.

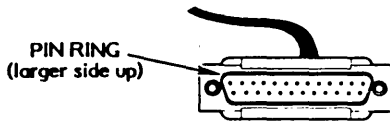

If you have a rigid disk drive, use the instructions on page 20 to remove the shipping bracket before connecting it to the screen.

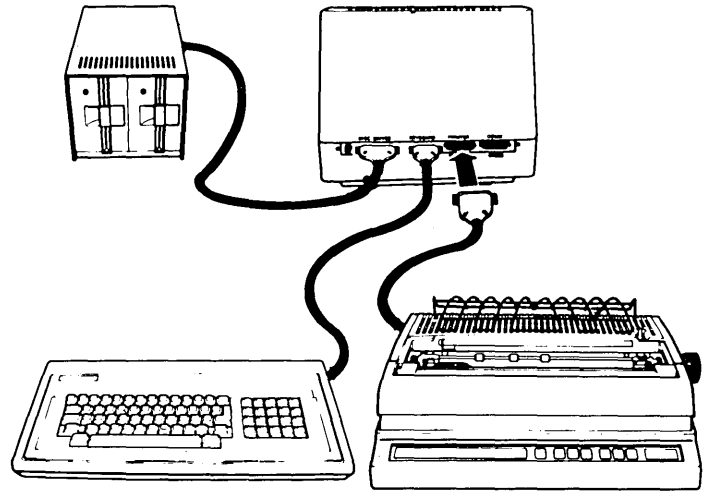

2. Secure the plugs with a screwdriver.

Be careful not to overtighten the screws.

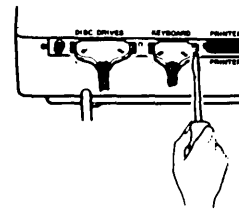

3. Plug the units into AC outlet.

If you have 5¼" disk drives, plug the power cord on the screen into an AC outlet.

If you have 8" floppy or rigid disk drives, plug the power cord on the screen into the back of the disk drive, then plug the disk drive into the AC outlet.

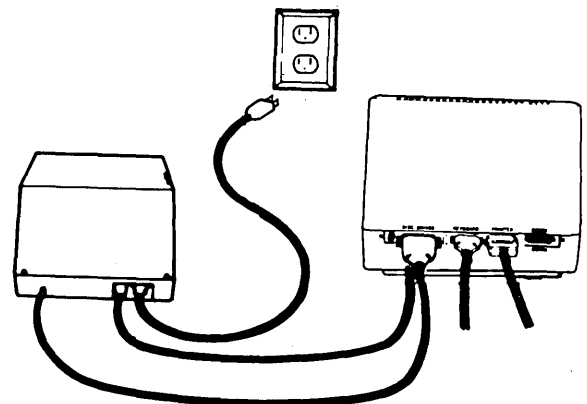
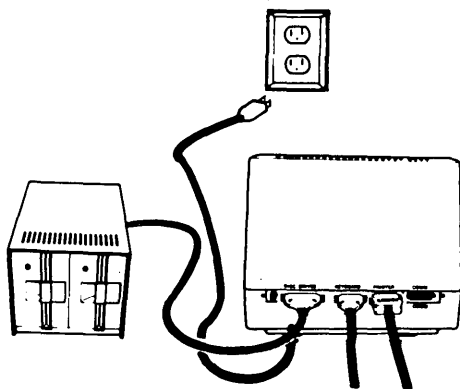

Note: If you have a printer with your 820-II, you'll need to check the installation instructions for the printer and then plug the printer into an AC outlet. (The Xerox printer instructions are in the System Component section of the CP/M and Word Processing Reference Manuals.)

8" RIGID DISK DRIVE INSTALLATION

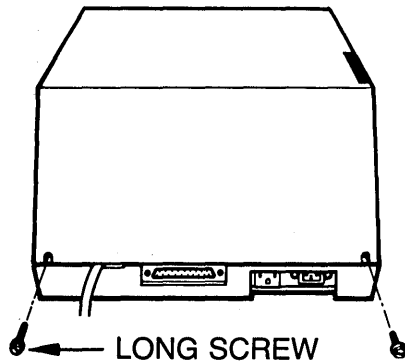

1 PREPARE THE RIGID DISK DRIVE:

Place the disk drives and the screen on your desk or table. Remove the two screws from the back of the disk drives cover. Notice that the left screw is longer than the right screw and must be reinstalled as the left screw when replacing the cover.

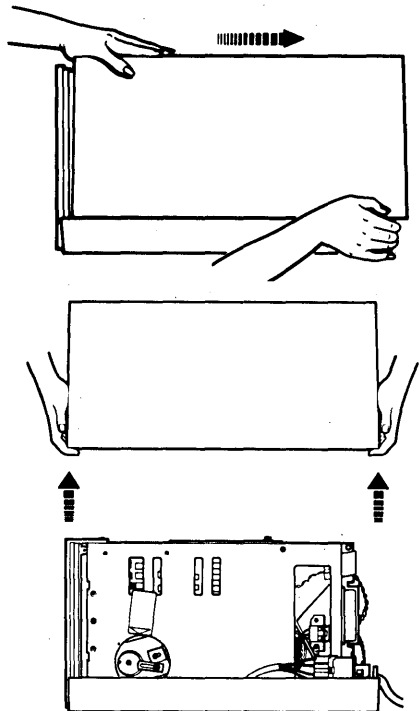

2 REMOVE THE DISK DRIVES TOP COVER:

Slide the cover toward the back of the drives until it stops. Lift the covers straight up and place it on your table or desk.

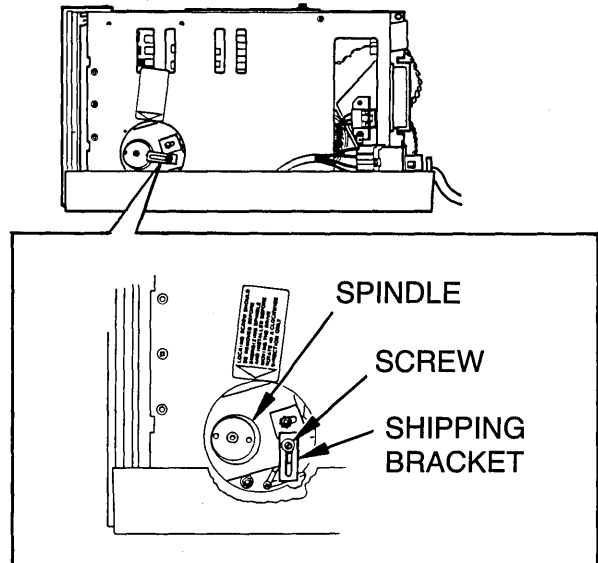

3 REMOVE THE RIGID DISK DRIVE SHIPPING BRACKET:

CAUTION: After removal of the shipping bracket, the spindle may be turned ONLY in a clockwise direction.

Remove the screw and shipping bracket from the right side of the rigid disk drive. Replace and position the shipping bracket as shown in the drawing with the protruding finger towards you (facing out) and screw it to the drive to save it.

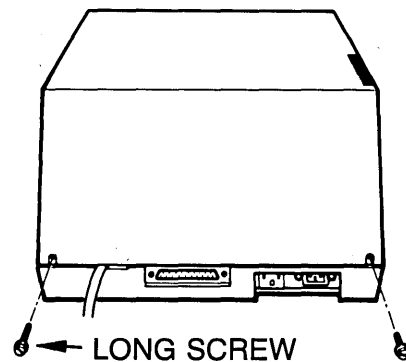

4 REPLACE THE RIGID DISK DRIVE TOP COVER:

Install the top cover and fasten it in place using the two screws removed earlier from the top cover. Make sure that you use the longer screw used for the left side.

GETTING STARTED ON THE 820-II

Once the system is installed, the equipment is ready for use. The display, printer and 8" disk drives have ON/OFF switches. A simple flip of the switch and the system is ready for operation.

STEP 1

Open both disk drives and remove any disks in the drives.

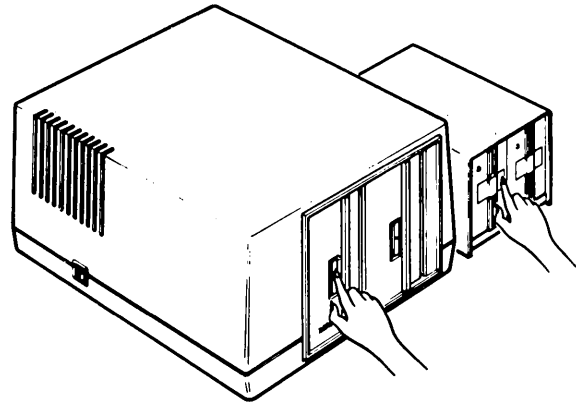

STEP 2

Turn on the display/processor (the switch is located under the right hand edge of the screen, near the back).

If you are using the 8" disk, turn on the power switch located on the lower left hand side of the drives.

The word XEROX will then appear on the screen. If it does not, try adjusting the brightness control located under the left edge of the screen, near the front.

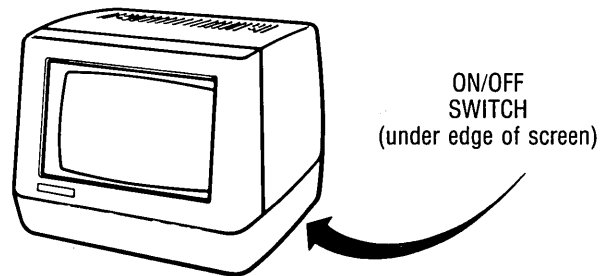

CHOOSING THE MODE OF OPERATION

After turning your 820-II on, you need to tell it how you want to use it. You have a choice of using it as a typewriter, a word processor, a computer or a data terminal.

To use the 820-II like a typewriter or terminal, you don't need any additional software. To use the 820-II in any of the other modes, you'll need the appropriate software disk. The message on the 820-II's screen tells you that you can type an **H** to use it as a host terminal, type a **T** to use it as a typewriter, or type an **L** to load (boot) the software option of your choice.

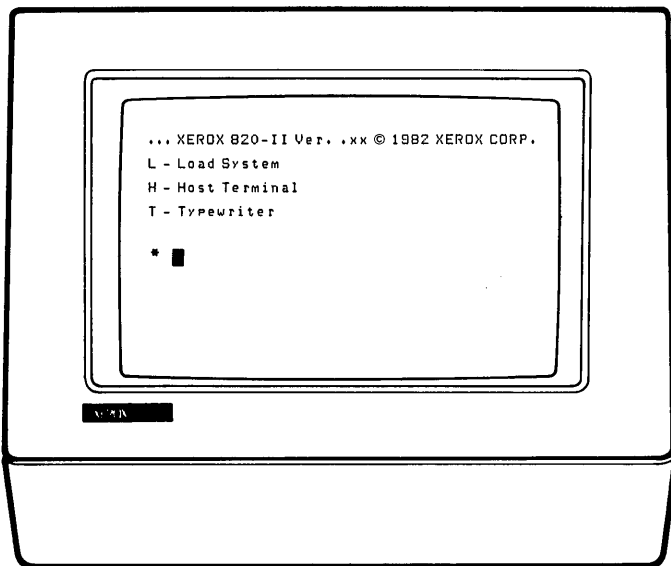

STEP 3

Tell the 820-II what you want to do next:

- Type the letter **T** and press the **RETURN** key to use the 820-II as a typewriter.
- OR, use the **L** instruction to load the software option of your choice, as described on the next page.
- OR, type the letter **H** and press the **RETURN** key to use the 820-II as a terminal (see page 26).

TYPEWRITER—The 820-II may be used as an electric typewriter simply by entering the typewriter mode. Once this mode has been selected, any information typed on the standard 96 character keyboard will print immediately. In this mode, nothing will be recorded on disk, but you can print a copy of anything displayed on the screen by holding down the CTRL key while you press the HELP key.

As a typewriter, the 820-II uses a left margin of 1, and a right margin of 132.

USING SOFTWARE DISKS

The operating strength of the 820-II is derived from its capability to use existing software packages. The 820-II's software library includes packages that make it operate like a word processor, a desk top computer and a communicating terminal. As a communicating terminal, the 820-II may be used to transmit data (e.g., single commands or lengthy files) to other communications devices, such as another 820-II or a host computer.

The steps below tell you how to load software into the 820-II's memory. Begin with a disk that has Word Processing or CP/M software on it.

STEP 4

Select the disk with the software you want to use. The disk must have either CP/M or Word Processing software on it.

To protect your software disk from accidental erasure, it is a good idea to write protect the disk. (For 8" disks, the write protect tape should be off, while 5¼" disks should have the tape left on. See page 13 for location of tape.)

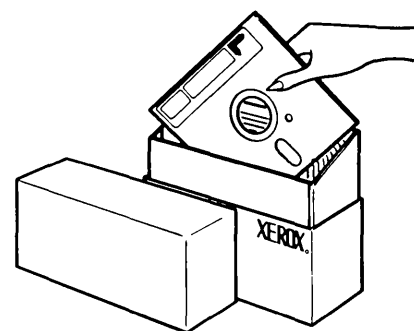

STEP 5

Insert the disk in the left disk drive, using the arrows on the disk as guides.

The 820-II floppy disk drives are referred to as A and B. Drive A is on the left and Drive B is on the right. The 4 partitions on the rigid disk drive are referred to as E through H.

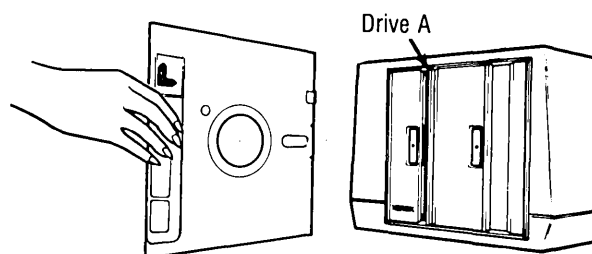

When you first load CP/M or Word Processing, you put the software disk in Drive A.

STEP 6

Close the disk drive, type the letters **LA** and press the **RETURN** key.

Typing **LA** and **RETURN** tells the 820-II to Load the software from Drive **A** into memory. If you have a rigid disk drive and have put your software on the rigid disk, you'd type **L** plus the rigid partition name (E, F, G, or H) where the software resides.

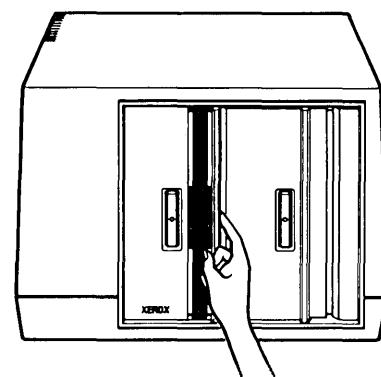

THE 820-II AS A DESK TOP COMPUTER

The 820-II becomes a desk top computer when the CP/M® 2.2 Operating System disk is inserted. CP/M provides a fast and highly flexible operating system for system execution. Its purpose is to make the hardware components work together. It acts on your commands and gives you a standard way to access the system's hardware resources.

The Xerox 820-II CP/M Manuals explain how to use the CP/M commands. The Handbook gives basic instructions and the Reference Manual goes into more detail. If you need a quick reminder of the CP/M commands, you can type the word HELP and press return to display a help file on the screen.

After you load the CP/M Operating System, you can use any of the CP/M application software packages (such as an accounts payable package, a financial spread sheet, a sorting program, etc.). Specific instructions can be found in the applications package manual.

To look at the contents of your CP/M disk, you use the DIR command. The names of all the files on the disk will display as shown below. The filenames will be separated by colons.

A:STAT

COM:PIP

COM:LETTER

:SYSGEN COM

When you type a filename that displays like this, you replace the spaces with a period and type **STAT.COM**

When you type a filename that displays like this, you simply type **LETTER**

THE 820-II AS A WORD PROCESSOR

When the Word Processing Software has been loaded, the 820-II is ready to use as a word processor/text editor. Many of the 820-II's features are currently only available on much more expensive systems.

Using your 820-II is like ordering food in a restaurant. When you sit down in a restaurant, you're usually handed a menu which is divided into several categories.

Appetizers
Entrees
and so on

May I take your order now?



When you sit down at your system, you're also given a selection of menus. Your first menu is similar to the Appetizer section (it lists "starting" options). On the 820-II Processor, this menu is called the "Directory". By responding to the menu selections you can use each of the many word processing features available.

| | |
|---|----------------------------------|
| This is the DIRECTORY MENU | |
| A = WORK ON A DOCUMENT FILE | H = run a program . . . for: |
| B = change disk drives | checking disk space, copying a |
| C = delete a file | disk & seeing B drive directory |
| D = turn directory off (ON) | ESC key = restart software |
| E = edit a program | HELP key = change help level |
| F = print a file | CTRL (-) = scroll directory down |
| G = rename a file | CTRL (=) = scroll directory up |
| You may touch any key shown above. | |
| DIRECTORY of disk B: EDIT RULER | |

| | | |
|--|--------------------------|---------------------------|
| B:FILENAME PAGE 1 LINE 1 COL 01 | | INSERT ON |
| MAIN MENU | | HELP = for assistance |
| 1 = go to menu | 7 = delete this line | E = change help level |
| 2 = block menu | 8 = insert line here | F = scroll up screenful |
| 3 = document menu | 9 = insert mode (on/off) | G = scroll down screenful |
| 4 = format (display) | 0 = repeat next command | J = find |
| 5 = format (nondisplay) | = = scroll up line | K = find & replace |
| 6 = reformat paragraph | - = scroll down line | L = repeat find & replace |
| You may type now -or- give a command using CTRL + (any key shown above). | | |

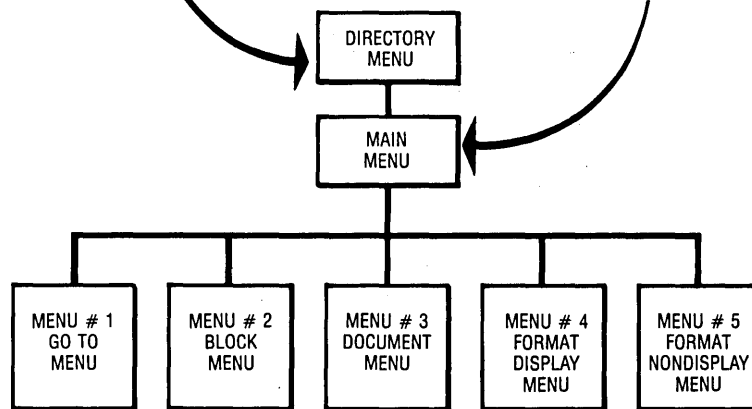

The Word Processing software is based on MicroPro International Corporation software, licensed to Xerox by MicroPro International Corporation, San Rafael, California 94901.

HOST TERMINAL

The 820-II may be used as a terminal to communicate with a host computer or time share system. Like the typewriter feature, the terminal features are in the hardware and do not require any additional software (unless you want additional capabilities available with communication software). As a host terminal, 820-II operates in the full duplex mode and can be remotely connected to the computer using dial-up modems or data sets.

In the terminal mode up to 700 lines of information can be typed on the screen or received through communications, stored in memory, printed and saved on disk.

You can use either the communications or printer port. If no port (parameter) is specified, the communications port will be used. To use the printer port, you would select B as the optional channel parameter (see directions below).

USING THE HOST TERMINAL

To use the Host Terminal application follow the instructions below. If you should make a mistake at any time you may touch the CTRL + ESC key and start over.

- Set the Baud rate (speed) and select the communications (Comm) port.

Example: Type **B7 A** and press the RETURN key to select 1200 baud and the communications port.

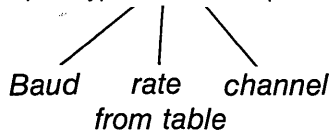

BAUD RATE TABLE

| | |
|-----|--------------|
| 0 = | 50 Baud |
| 1 = | 75 Baud |
| 2 = | 110 Baud |
| 3 = | 134.5 Baud |
| 4 = | 150 Baud |
| 5 = | 300 Baud |
| 6 = | 600 Baud |
| 7 = | 1200 Baud |
| 8 = | 1800 Baud |
| 9 = | 2000 Baud |
| A = | 2400 Baud |
| B = | 3600 Baud |
| C = | 4800 Baud |
| D = | 7200 Baud |
| E = | 9600 Baud |
| F = | 19,200 Kbaud |

- Type the letter **H** and press RETURN to enter the terminal mode.

(You may type and manipulate up to 700 lines on the screen and in main memory. To begin typing, hold down CTRL and press DEL key, then hold down CTRL and press LINE FEED key. For more information, see the key commands on the next page.)

- Follow the directions for your Data Phone or Modem to begin communications.
- To print information displayed on the screen, hold down CTRL and press the HELP key.
- To save information received or typed on screen (up to 700 lines):
 - End the communications session.
 - Scroll the information *off* the screen by typing RETURNS (this places the information in the main memory).
 - Place your CP/M disk in the left drive, type LA and press RETURN.
 - Remove the CP/M disk and insert an initialized data disk.
 - Type **SAVE 220 "filename"** to save the information on disk.

| | |
|-------------------|--|
| CTRL + DOWN ARROW | Scrolls information down on the screen. |
| CTRL + UP ARROW | Scrolls information up on the screen. |
| CTRL + DEL | Enable local echo. Characters transmitted and received will be displayed on the screen. |
| CTRL + LINE FEED | Enable local auto line feed. When the RETURN key is touched a line feed is also sent to the local screen but not transmitted. |
| CTRL + 1 | Enable remote echo. Characters received will be echoed back to the transmitting device. In this mode the Xerox 820-II can act as a host to another terminal. |
| CTRL + 2 | Enable remote auto line feed. Carriage return characters received will be echoed to the remote device as a carriage return and line feed codes. |
| CTRL + . (period) | Transmit BREAK. When these keys are touched a break condition will be enabled until CTRL + . is touched or any other character is typed. |
| CTRL + ESC | Exit the Host Terminal mode. |

If you are connected to the host computer with a Data Phone and Modem, refer to the instruction guide for your particular modem and host computer.

HOW IS THE 820-II DESIGNED?

BASIC CONCEPT

The 820-II system is designed to provide maximum versatility. This is accomplished by minimum use of fixed functions and maximum use of user selected functions. This approach to system design provides a "today" computer that has the capability to make maximum use of tomorrow's software. Xerox is committed to meeting the customer's future needs by providing expanded software packages, upward compatibility with other Xerox products and standard interface with the Xerox local communications network—ETHER-NET.

HARDWARE DESIGN

The heart of the 820-II system is a 64K random access memory (RAM) Z80-A microprocessor driven at a clock speed of 4MHz, with a switchable 6K Read Only Memory (ROM). The 6K ROM unit is switched into the system at startup to provide the system with the basic ability to load the user selected functions into the central processor unit (CPU). Only seconds after turn-on, the 820-II CPU is performing the user defined tasks. At the touch of a key the 820-II converts from an electric typewriter to a powerful word processor or any of the many scientific processing systems available today. And tomorrow, the 820-II will be as up-to-date as the latest software; because the functions of the 820-II are completely controlled by user selected software.

SPECIFICATIONS

Display Screen: 24 lines, 80 characters per line displayed white on black background, with brightness control.

Keyboard: Separate unit from Display Screen.

Printer Speed (40 CPS): Up to 40 characters per second, bi-directional.

Writing Line: 13" standard

Platen: 14.5" standard

Ribbon Cartridges: Interchangeable film or fabric.

Printer Speed (25 CPS): Up to 25 characters per second, bi-directional

Writing Line: 13.2" standard

Platen: 14.5" standard

Ribbon Cartridges: Interchangeable film

Size & Weight

Display Unit: Height 12.87", Width 14.5", Depth 13.5"
Weight 30 lbs.

Keyboard: Height 3.75", Width 20", Depth 9.5"
Weight 10 lbs.

Disk Unit (5¼"): Height 6.7", Width 8", Depth 9"
Weight 10 lbs.

Disk Unit (8" Floppy): Height 10.75", Width 14", Depth 17.5"
Weight 48 lbs.

Disk Unit (8" Rigid): Height 10.75", Width 15.5", Depth 17.5"
Weight 54 lbs.

Printer (40 CPS): Height 8.5", Width 24.5", Depth 19"
Weight 56 lbs.

Printer (20 CPS): Height 9.25", Width 24.25", Depth 17.75"
Weight 50 lbs.

Disk Storage Capacity:

5¼" Floppy (double density)

155K formatted (78 pages approx.) per drive, per side

8" Floppy (double density)

482K formatted (241 pages approx.) per drive, per side

8" Rigid (10 mb)

8.192 Mb formatted per drive

Electrical Requirements:

System Voltage: 90-132 VAC single phase
(two wires plus ground)

Frequency: 59.5-60.5 Hz

Current: One Display (Controller, Display, Keyboard and Printer) can be connected to a 15 amp circuit.

Amps: System with 5¼"

Disk Drive 1.5 amps

System with 8"

Disk Drive 3 amps

Xerox Printer 2 amps

Environmental Requirements:

Operating: 50° to 90° F
20% to 80%, humidity

Non-operating: -20° to 150° F
15% to 90%, humidity

TECHNICAL ASPECTS OF STARTUP

LOADING THE MONITOR

The 820-II system is initialized at "power on" or at the pressing of the reset button. Upon this command the low page of RAM is switched to the monitor ROM and copied into the high page (4K) of RAM. The low page is then switched back to RAM for use as the stack register.

INITIAL FUNCTION SELECTION

After it is loaded, the monitor will display a screen request for the user to select the basic operating mode. The user may select typewriter (T) mode, host terminal mode (H), or system boot (L). In the typewriter mode the 820-II keyboard interacts with the printer in electric typewriter fashion. In the host terminal mode the 820-II will communicate through either the printer or comm ports.

SYSTEM BOOT MODE (L)

If the user selects the boot mode (L), the monitor will load an executable program of fixed length from disk A (or any disk specified), Track 0, Sector 1. This program is loaded into the CPU location 80 hex. The monitor then transfers control to the loaded program. This initial program is a loader routine for the user selected system function (word processor, CP/M, etc.). It is specifically designed to load the disk software into memory and begin execution. The memory locations occupied by the initial loader program are utilized by the software as a utility or stack register area.

DESIGN CONCEPT

The design concept of initial monitor loading of a specialized system loader is one of the key elements in providing the user with maximum system versatility. The association of loader routine and system software insures the user that the 820-II system can respond to any computing need, today or tomorrow.

MEMORY MAP FOR CP/M SYSTEM

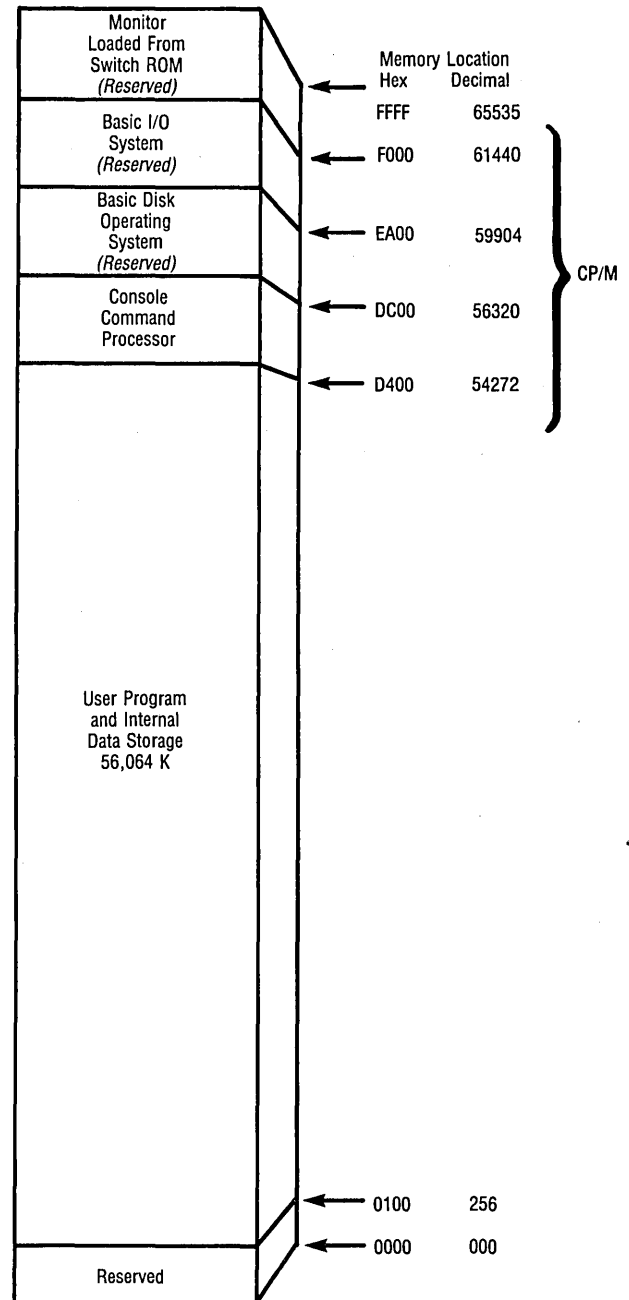

STANDARD SERIAL INTERFACE

The 820-II has two Serial I/O ports with the capability of supporting full RS-232 protocol on both ports. In addition, the COMM port can provide clocks to synchronous modems or receive clocks from the modem.

The COMM port can be configured to interface to a modem or a terminal. The PRINTER port is dedicated for printer operation and has no strapping options.

COMM (CHANNEL A)

| PIN | RS232 SIGNAL |
|-----|---------------------|
| 1 | GROUND |
| 2 | TRANSMIT DATA |
| 3 | RECEIVE DATA |
| 4 | REQUEST TO SEND |
| 5 | CLEAR TO SEND |
| 6 | DATA SET READY |
| 7 | GROUND |
| 8 | CARRIER DETECT |
| 15 | TRANSMIT CLOCK |
| 17 | RECEIVE CLOCK |
| 20 | DATA TERMINAL READY |

PRINTER (CHANNEL B)

| PIN | RS232 SIGNAL |
|-----|---------------------|
| 1 | GROUND |
| 2 | RECEIVE DATA |
| 3 | TRANSMIT DATA |
| 4 | CLEAR TO SEND |
| 5 | REQUEST TO SEND |
| 6 | DATA SET READY |
| 7 | GROUND |
| 8 | DATA CARRIER DETECT |
| 20 | TERMINAL READY |

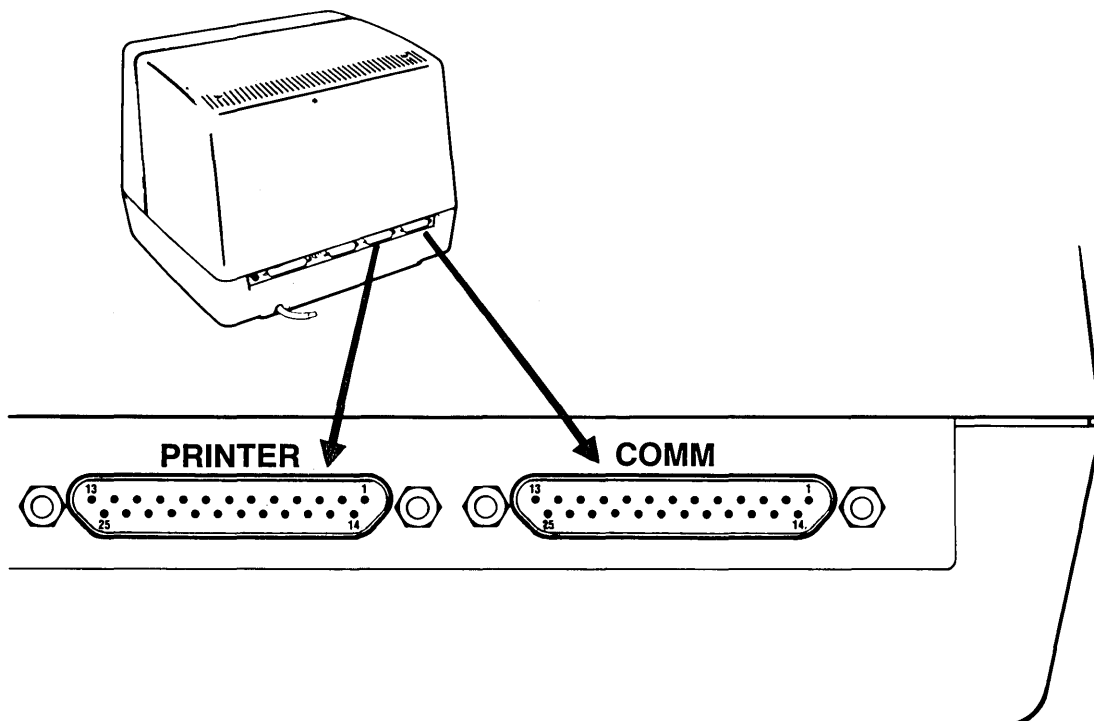

GENERAL PURPOSE PARALLEL INTERFACE

A Z80 PIO chip has been included on the Xerox 820-II for general purpose input/output interfacing. The two independent 8 bit parallel ports can be used to interface to printers, ROM programmers, analog converters, other computers, or just about anything. Xerox 820-II manuals contain schematic drawings and data necessary to access this versatile 820-II feature.

| PIN | ASSIGNMENT | |
|------|------------------------------------|--------|
| 2 | STROBE | PORT A |
| 4 | READY | |
| 6 | BIT 0 | |
| 8 | BIT 1 | |
| 10 | BIT 2 | |
| 12 | BIT 3 | |
| 14 | BIT 4 | |
| 16 | BIT 5 | |
| 18 | BIT 6 | |
| 20 | BIT 7 | |
| 22 | READY | PORT B |
| 24 | STROBE | |
| 26 | BIT 0 | |
| 28 | BIT 1 | |
| 30 | BIT 2 | |
| 32 | BIT 3 | |
| 34 | BIT 4 | |
| 36 | BIT 5 | |
| 38 | BIT 6 | |
| 40 | BIT 7 | |
| 1-39 | All odd numbered pins are grounded | |

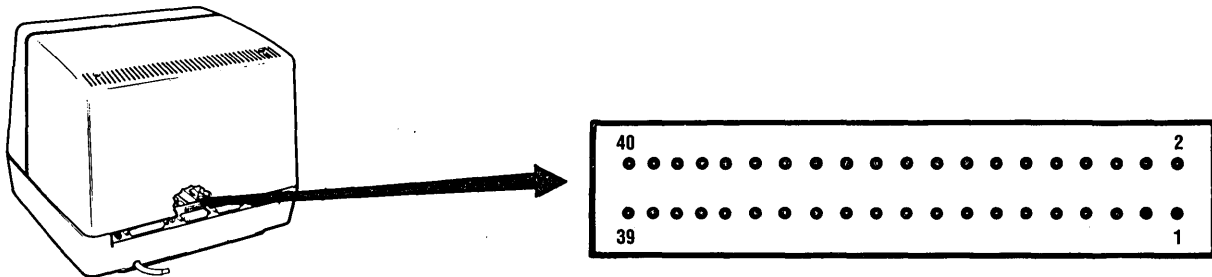

A VERSATILE SYSTEM MONITOR

BASIC CONTROLLER

The monitor provides two essential functions for the Xerox 820-II system. It is the initial software level of the computer and it contains the routines that initialize and control all the basic system input/output resources. The "front panel" functions of the monitor include commands to display and alter the contents of memory and I/O ports, to begin execution at a given address, and to bootstrap programs from disk. The basic I/O functions of monitor provide driving routines for the built-in CRT display and keyboard input, and the floppy disk controller. In this capacity the monitor is always active, even when application programs like the CP/M disk operating system have control of the CPU.

A VERSATILE SYSTEM MONITOR

| | |
|-----------------------------|---|
| COPY (C) | The copy command allows blocks of data to be moved in memory. |
| DISPLAY MEMORY (D) | The display memory command produces a tabular display of the contents of memory in hexadecimal and ASCII. |
| FILL (F) | The fill command allows blocks of memory to be filled with a fixed data constant. |
| GO TO (G) | The go to command allows control of the CPU to be passed to another program (i.e., begin execution of software). |
| INPUT (I) | This command allows the contents of input ports to be read. |
| OUTPUT (O) | This command allows the output ports to be written to. |
| LOAD (L) | The load command is used to load and begin execution of a one sector long bootstrap loader from the first sector on a specified disk drive. |
| READ (R) | The read command allows individual disk sectors to be read into memory and displayed on the console. |
| MODIFY MEMORY (M) | The modify command allow the contents of individual memory locations to be read from and written to. |
| TYPEWRITER (T) | The typewriter command establishes a direct link between the keyboard and the printer. |
| VERIFY (V) | The contents of memory locations are compared to other memory locations to check if the same data is stored. |
| EXTENDED MEMORY TEST (X) | This command will test a specified range of memory. |
| HOST TERMINAL (H) | The terminal command establishes communications through either the comm or printer ports. |

128 CHARACTER DISPLAY SET

CHARACTER DEFINITIONS

Each character is defined by a unique eight bit code which is represented by a hexadecimal code 'XY' where X represents the 4 most significant bits of the code and Y represents the 4 least significant bits of the code.

There are a total of 128 characters in the font set. Therefore, Y represents a hexadecimal number from 0 to F, and X represents a hexadecimal number from 0 to 7. Therefore, the complete font set is defined by codes from 00 to 7F. If the most significant bit of the eight bit code is set to '1', then the complete font set is duplicated with the special (blink, inverse video or low intensity) attribute set. The special set of characters is then defined by codes from 80 to FF.

SPECIAL EFFECTS

With a Xerox 40 or 25 cps printer, the character set is further enhanced by the overstrike capability. This feature allows the generation of **bold face** type and the combination of characters for underlining and unique symbols.

| Y | 0 | 1 | 2 | 3 | 4 | 5 | 6 | 7 | 8 | 9 | A | B | C | D | E | F |
|---|---|---|---|---|----|---|---|---|---|---|---|---|---|---|---|---|
| X | | | | | | | | | | | | | | | | |
| 0 | □ | ¢ | ■ | ● | § | ½ | ¼ | ± | ← | ↑ | ↓ | ↔ | ⊞ | ⊞ | ⊞ | ⊞ |
| 1 | ³ | ² | ° | — | ∇ | ¶ | ± | μ | + | | ← | ← | ⊞ | → | ← | ⊞ |
| 2 | | ! | " | # | \$ | % | & | ' | (|) | * | + | , | - | . | / |
| 3 | 0 | 1 | 2 | 3 | 4 | 5 | 6 | 7 | 8 | 9 | : | ; | < | = | > | ? |
| 4 | @ | A | B | C | D | E | F | G | H | I | J | K | L | M | N | O |
| 5 | P | Q | R | S | T | U | V | W | X | Y | Z | [| \ |] | ^ | _ |
| 6 | | a | b | c | d | e | f | g | h | i | j | k | l | m | n | o |
| 7 | p | q | r | s | t | u | v | w | x | y | z | { | | } | | ™ |

CARE OF FLOPPY DISKS

HANDLE WITH CARE

The 820-II disks are designed for maximum recording fidelity and long life. However, it is very important that you exercise care in the handling of the disks. The disk is very similar to an audio or video magnetically recorded tape. Dust, oil, scratches, or wrinkles can permanently ruin a disk.

PRECAUTIONS

- Store the disk vertically in its storage envelope away from magnetic fields (such as electrical equipment with motors or transformers), heat, sunlight, dust and cigarette ashes.
- Remove the disk before turning off the disk drive and do not insert the disk until after the drive is on.
- Do not attempt to clean the disk surface or touch it in any manner. Disks should be handled by the jacket only.
- The disk jacket should not be labeled with a hard-point writing instrument. Writing pressure can damage the disk inside the jacket during the labeling process.

LABELING DISK

Disk labels should be confined to permanent information only. Each storage disk may be assigned a permanent number which can be cross referenced to contents. This labeling system allows you to change disk contents without changing the jacket label. In most cases the disk will last longer than the usefulness of the data stored on it.

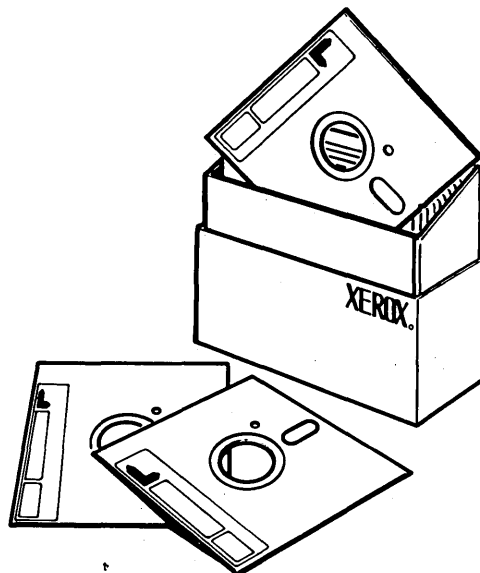

EXTENSIVE SOFTWARE AVAILABLE

The ease of operation and flexibility afforded by CP/M has resulted in the development of numerous software application packages ranging from business-oriented application software to scientific packages. Off-the-shelf programs for virtually any application may be readily located and implemented on the 820-II. Today there are hundreds of packages from over 400 software vendors which may be readily implemented on the 820-II.

Up-to-date catalogues of available software packages may be obtained by contacting your local Xerox distributor.

ABSTAT
Anderson-Bell
\$400
Interactive statistical package. data base up to 20 variables. menu-driven. Requires 8" disks & 132 char. printer.

ACCOUNTANT
Hayden Book Company, Inc.
\$1000
40 programs for billing, collection, reports for pre-payment ledger, accounts receivable analysis. type is CBASIC-II &

Accounts Payable
Conceptual Systems Inc
\$750
Detailed vendor information, invoice entry, open voucher processing, comprehensive reports (vendor list, open voucher report, A/P aging report, trial payments, checks, check register), automatic journal posting, & password protection.

Accounts Payable
CYMA CORPORATION
\$575
Stand-alone system or integrated with CYMA accounting & job costing system. Allows up to 26 different terms with broken check register & checks.

Accounts Receivable
Balcones Computer Corporation
See BOSS Financial Accounting Package.
\$200

Accounts Receivable
Computer Professionals, Inc.
\$750
7 reports & 22 system functions make up the system. Stock Moore forms are used (or plain paper) for invoices & statements. Aged receivables reporting, open item balance forward processing, automatic interface to CP/M G/L systems, up to 400 of open items. Menu-driven system. Note: no automatic inventory interface. Requires 8" disks & 132 char. printer.

Accounts Receivable
Conceptual Systems Inc.
\$750
Standard methods: variable aging periods; on-line query; data entry; billing cycles; account distribution; reports (statements, customer aging report, open item report, summary aging report, G/L summary). Fully integrated with the G/L system (or may optionally be run as a separate package); & password protection.

Accounts Receivable
CYMA CORPORATION
\$575
Capability of handling combinations of Open Item, Balance Forward, or Contract Receivables with Payment Aging & Full sensitivity allows for Variable Aging & Full Due Report. Calculates finance charges and discounts based on terms. Over-Limit amounts. Prints invoices and bills. Includes optional message area, printed in alphanumeric or integrated order. Stand-alone system or integrated with G/L. Requires 8" disks.

Accounts Receivable
Designer Software
\$850
User defined aging periods, balance forward or open item accounting by customer; average aged balances; multiple aging cycles; company number menu; billing cycle; vendor number printed in alphanumeric or integrated order. Stand-alone system or integrated with G/L. Requires 8" disks.

Accounts Receivable
Micro Data
\$500
Calculation of activity by service code; calculates finance charge; automatic accounts aging at month end; ability to change past balances; customer monthly statements aging & delinquency report; last payment information; transaction registers. Requires CBASIC-II, QSORT, 132 char. printer & 8" disks.

Accounts Receivable
Micro Business Software, Inc.
\$1000
Open item & balance forward A/R system for small businesses, provides maintenance & lists of assessments & cash receipts; allows sales transactions with add list & journal; printing status inquiry, automatic calculations & posts financial charges; journal account status inquiry; automatically calculates & posts statements; control commissions due & prints reports; prints A/R distributions to G/L; may be interfaced to the MISI G/L & Sales Analysis. Requires 8" disks.

Accounts Receivable
Micro Architect, Inc.
\$1450
Instant customer account information (current & aged) with complete invoicing & statement capabilities. Supports both open-item & balance forward accounts. A/R integrates with G/L or stand-alone. Fast ISAM; interactive, menu-driven, self-instructing, flexible, & sophisticated. Comes with 100+ page manual & installation guide. 800 accounts. Requires 8" disks & 132 char. printer.

Accounts Receivable
R & E Business Systems Inc.
\$1,500
System for accumulating invoice data for customers. Statements aged trial balances & delinquencies. Available as batch or on-line system or integrated to G/L. Includes: detailed invoice entry by monthly cycle; standing system or integrated with monthly cycle; automatic aging by monthly cycle; delinquency reporting; maintains late fees; date statistics by customer; detail daily activity lists for balancing to source G/L. Requires BASIC-80 (Xerox level 5.0 is compatible), 132 char. printer, two 8" disks.

Accounts Receivable
Small Business Systems Group, Inc.
\$500
Prepare accurate & timely monthly statements to credit customers. Management can generate information required to control the amount of credit extended; prompt payment of invoices; creditable credit sales while minimizing loss from bad debts. Invoices, credit memos, & debit memos can be entered for a customer on file before ready for use. Tax codes, G/L distribution for payments & full or partial payments. Major reports include: customer progress reports; update reports; detail lists with activity; update invoices not yet billed; open, closed, & aged. This product may be interfaced with an invoicing module for invoice production & other invoice tasks. Requires 132 char. printer & 8" disks.

Accounts Payable
Peachtree Software, Incorporated
\$600+
Programs include vendor file list & maintenance, enter vouchers & credits, report generation, check printing & register, vendor account status query, end-of-period processing, & general utility functions. Outputs include vendor file list, open vouchers, A/P aging, cash requirements, check register, checks, & G/L transaction register. Inputs to G/L package. Requires BASIC-80 (Xerox level 5.0 is compatible) & 132 char. printer, & two 8" disks.

Accounts Payable
R & E Business Systems Inc.
\$750
Maintain vendor files & payables. Date-sensitive reporting to assist in meeting discount dates; instant access to invoices payable by vendor; preliminary reports by vendor & date to assist in determining cash requirements; aged payables; maintain vendor statistics; & automatically updates G/L system.

Accounts Payable
Small Business Systems Group, Inc.
\$500
Invoice-oriented A/P system; records, processes, & ages invoices, credit memos, & debit memos resulting from purchases & credit acquired through day-to-day dealings with various suppliers. Vendor & transaction information is available for print & file maintenance to insure accuracy. Update Report supplies detail & G/L distribution totals for handposting. System calculates & produces checks in payment of outstanding invoices & applies credit memos. Reports include: check register report, open & closed item listings (detail & summary), debit & credit memo listings, & aging analysis. Requires 132 char. printer & 8" disks.

Accounts Payable
Univar, Inc.
\$500
Allows the operator to automatically write checks for vendors & suppliers who have invoices due; scans files for invoices due; pays all or an operator-determined portion of the invoice; provides double entry posting to G/L, if desired. Requires 8" disks & CBASIC-II.

Accounts Payable
Structured Systems Group, Inc.
\$600+
Features include flexible payment, automatic verification of input data at time of entry, check writing from stored data, automatic numerical control of checks, automatic computation of discounts, scheduling of payables, summarizing of expenses, updating to G/L, & hard copy reports. Reports include: aged trial balance, pre-check reports, aged cash requirements, check register, checks, summary accounts distribution, vendor list, & account list. Requires two single density 8" disks & 132 char. printer. Supports approximately 1000 vendors, 200+ ledger accounts, up to 1000 transactions payable at a time.

Accounts Payable
tiny SYSTEMS, Inc.
\$750
Alphabetical listing of all vendor accounts; displays & updates all account information/available discounts, discount terms, records purchases, payments, & adjustments with automatic aging; displays account transaction histories; selective purge of histories; periodic purge of fully paid transactions. Purchase journal, cash requirements schedule; automatic check writing (partial & manual payments); check register; payables disbursements journal; aged trial balance. Fully integrated; automatic entry to G/L.

Accounts Payable
Job Costing
Information Systems of Arkansas
\$700
Contains all features of ASI A/P. In addition, each invoice entered may be changed to a job account, & an A/P Job Information report is available. System is fully integrated with ASI's Job Costing & G/L systems. Requires 132 char. printer.

Accounts Payable
Management System
Univar, Inc.
\$500
Allows the operator to automatically write checks for vendors & suppliers who have invoices due; scans files for invoices due; pays all or an operator-determined portion of the invoice; provides double entry posting to G/L, if desired. Requires 8" disks & CBASIC-II.

NON-XEROX PRINTERS

When you buy a Xerox 820-II Personal Computer, it is set up to work with the Xerox 20 and 40 character per second printers. It is possible, however, to use other serial and parallel printers with the 820-II. Using a different printer will require modification to the software so that the 820-II will send data to the printer in a format that the printer will understand.

MODIFYING THE SOFTWARE

Both the CP/M and Word Processing disks contain a program called **CONFIGUR**. This program lets you configure (modify) the software to work with a non-Xerox serial or parallel printer. Instructions for using the CONFIGUR program are in the Reference Manual. The program will display a menu from which you can select the information that pertains to your printer. You should check your printer's instruction manual to find out what "Protocol" and "Baud Rate" it uses before you fill in the CONFIGUR menu.

INSTALLING THE PRINTER

The cables necessary to connect both serial and parallel printers to the 820-II can be purchased from Xerox.

If you have a serial printer, connect it to the PRINTER port on the back of the screen. Make sure both the printer and the 820-II are turned "off" before you make the connection. The serial printer cable has the same type of connector at both ends, so you can connect either end to the 820-II.

If you have a parallel printer, connect it to the parallel port inside the 820-II display unit. Detailed instructions on how to install the parallel cable are given in the "System Component" section of the Reference Manual. The removal of two screws (after turning power "off" and unplugging the screen) allows access to the internal parts of the display unit. The installation of three "jumpers", the parallel cable plug and a ground wire is all that is required.

GLOSSARY OF COMPUTER TERMS

Assembly Language A language similar in structure to machine language, but made up of mnemonics and symbols. Programs written in assembly language are slightly less difficult to write and understand than programs in machine language.

BASIC Stands for Beginner's All-Purpose Symbolic Code. BASIC is one of the most popular "high level" computer languages available. It is referred to as high level because it makes use of English language commands to write the program.

Baud Refers to the rate at which digital information is transmitted or communicated to another system. The baud rate is given in bits per second, and since each transmitted character has 10 bits on most systems, the baud rate must be divided by 10 to get characters per second. For example, a baud rate of 1200 will transmit 120 characters per second.

Bit The smallest piece of information a computer can handle. A bit represents either an on or off condition in the system's electronics (or 0 or 1 in the binary number system). Several bits (usually 8 or 16) are combined to make a character, just as several characters are combined to make a word.

Byte A byte is equivalent to one character. For example, the word "and" is three bytes: "a", "n" and "d" are each one byte. On the 820, each byte is made up of 8 bits. The storage space on a disk is usually given in bytes; for example a disk that has 81,000 bytes will hold 81,000 characters.

Bug Used to refer to a problem or malfunction or an operation that is contrary to the documentation in a program or a system.

Bus A port or group of ports (plugs or electronic circuits) that provide the capability to connect two or more microprocessors or input/output devices. The port includes lines for data, memory address and processor control.

CP/M® Stands for Control Program for Microprocessors. CP/M is a registered trademark of Digital Research, Inc., and is an industry standard operating system for small computers. CP/M tells the components of your system (the keyboard, disk drives, screen and printer) how to work together: how to display a character typed on the keyboard on the screen, how to record information typed on the screen on the disk, how to print information on the disk at the printer, etc.

CPU Stands for Central Processing Unit, which is a computer's main processing center. The CPU is the brains of the system: it holds the control system, arithmetic and logic units and some memory. The CPU is where information from the disk and keyboard are processed.

CRT Stands for Cathode Ray Tube, which is the system's screen or display device.

Debug Refers to the process of finding and correcting mistakes or problems in a software program.

Glitch An error or problem in the computer components. Usually refers to a problem caused by line noise (inconsistencies in the electricity) or electromagnetic interference.

High-level Language Any programming language that uses English-like commands, such as BASIC, COBOL, FORTRAN, Pascal, etc. These languages are easy for beginners to learn. The computer must change the commands into machine language through software programs called interpreters or compilers.

CP/M® is a registered trademark of Digital Research Incorporated, Pacific Grove, California.

D

APPENDIX

I/O Stands for Input/Output and refers to any device that sends information to and accepts information from the computer. A disk drive is an example of an I/O device.

K Refers to Kilo or 1,024 in computer terms. Frequently used to describe memory or disk capacity in bytes. A disk that holds 81K, actually holds 82,944 characters.

Machine Language Refers to the digital or binary code that is the language a computer works in. When you use a high-level language (like BASIC), the software must convert your instructions into machine language before the computer can take action.

Modem An abbreviation for the term "modulator-demodulator". A modem is a device used to change computer signals into signals that can be sent along a telephone line. When the signals are received by another modem, they are translated back into computer signals.

Operating System Refers to the group of programs that control the computer's internal functions and tells the components of the system how to work together. (Also see definition for CP/M.)

Peripheral An external device that communicates with a computer. Printers and disk drives are examples of peripherals.

Programming Refers to the process of writing instructions (a program) in a language that a computer can understand and act on.

RAM Stands for Random Access Memory, which is the portion of the computer's memory that is used for programs, data manipulation and temporary data storage. When you load a program into memory, it goes into RAM. Since RAM is only a temporary memory, everything in it is lost when the power is turned off.

ROM Stands for Read Only Memory, which is the portion of the computer's memory which is pre-programmed and not loaded from a software disk. The information in this memory tells the computer how to operate internally. For example, the message you see on the 820's screen when you turn it on comes from the ROM.

Software Refers to computer programs which can be loaded into memory from a disk (or other media). The software can be an Operating System (such as CP/M), programs for accounting or word processing, or a BASIC language program that you wrote yourself.

XEROX

XEROX CORPORATION
1341 West Mockingbird
Dallas, Texas 75247

XEROX is a trademark of XEROX CORPORATION
Printed in U.S.A.

9R80380

102660719