

SRPL8

Server System

Quick Start Guide

Order Number: A49446-001

- ⇒ **How to do basic set-up, boot from the configuration software CD, install the optional slide rail kit, and access the Product Guide from the CD.**

Copyright © 2001 Intel Corporation. All rights reserved. No part of this document may be copied, or reproduced in any form, or by any means without prior written consent of Intel.

Intel Corporation (Intel) makes no warranty of any kind with regard to this material, including, but not limited to, the implied warranties of merchantability and fitness for a particular purpose. Intel assumes no responsibility for any errors that may appear in this document. Intel makes no commitment to update nor to keep current the information contained in this document.

This equipment has been tested and found to comply with the limits for a Class A digital device, pursuant to part 15 of the FCC Rules. These limits are designed to provide reasonable protection against harmful interference when the equipment is operated in a commercial environment. This equipment generates, uses, and can radiate radio frequency energy and, if not installed and used in accordance with the instruction manual, may cause harmful interference to radio communications. Operation of this equipment in a residential area is likely to cause harmful interference in which case the user will be required to correct the interference at his own expense.

† Third-party brands and names are the property of their respective owners.

Contents

Server Specifications.....	5
Select Site.....	6
Optional Slide Rail Kit.....	7
Equipment Rack Precautions.....	7
Prepare the Slide Assemblies.....	8
Attach the Rail Slide Rail Brackets to the Equipment Rack.....	10
Attach the Center Bar and Large Outer Bar Assemblies to the Equipment Rack.....	11
Install the Server in the Rack.....	12
Check Power Cord.....	13
Power Cord Requirements.....	13
Connect Monitor, Keyboard, Mouse.....	15
Turn on Video Monitor and Server.....	16
Run Power-on Self Test.....	18
Boot from CD.....	19
Change Boot Device Priority.....	20
The Server Product Guide.....	20
Using the Acrobat .PDF Files.....	20
Copy Configuration Software to Diskettes.....	21
Warnings.....	22
WARNING: English (US).....	23
AVERTISSEMENT: Français.....	25
WARNUNG: Deutsch.....	27
AVVERTENZA: Italiano.....	29
ADVERTENCIAS: Español.....	31



WARNINGS

READ WARNINGS: Before operating this server, read the warnings beginning on page 22.

AVOID INJURY: To avoid personal injury when unpacking the server, use only a mechanical assist unit to lift it off the shipping pallet. The minimum server configuration weighs 51 kg (113 lbs); the maximum weighs 63.5 kg (140 lbs).

Do not attempt to lift or move the server by the handles on the power supplies.

Use only a hand-truck or other mechanical assist unit to move the server from one location to another.

Server Specifications

Table 1. SRPL8 Server Physical Specifications

Specification	Value
Height	31.12 cm (12.25 inches, 7u)
Width	44.45 cm (17.5 inches)
Depth	71.12 cm (28.0 inches)
Weight	51.4 kg (113 lbs) minimum configuration 63.5 kg (140 lbs) maximum configuration
Required front clearance	10 inches (inlet airflow <35 °C / 95 °F)
Required rear clearance	8 inches (no airflow restriction)

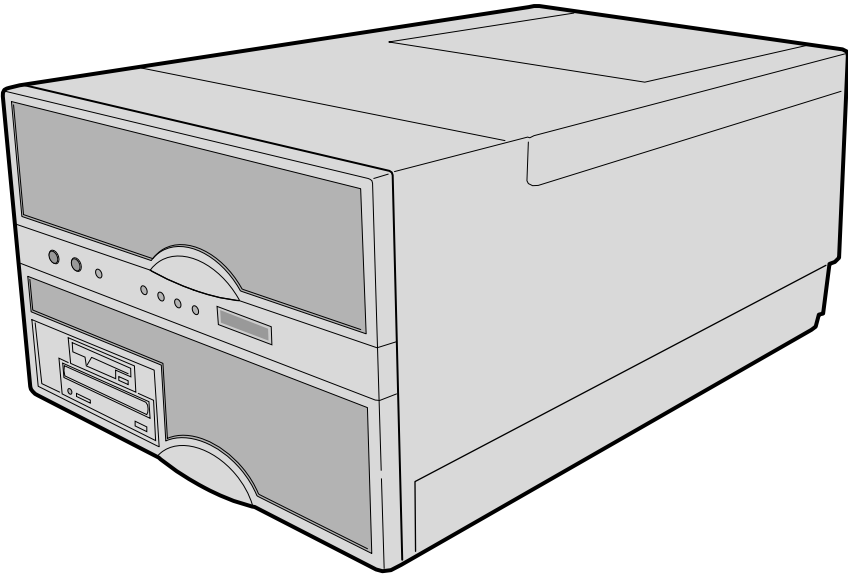

OM08751

Figure 1. SRPL8 Server

Select Site

WARNING

The push-button on/off power switch on the front panel of the server does not turn off the AC power. To remove AC power from the server, you must unplug the AC power cord from the server or wall outlet.

CAUTION, ESD precautions

Electrostatic discharge (ESD) can damage disk drives, add-in boards, and other parts. This server can withstand normal levels of environmental ESD. However, we recommend doing all procedures in this guide only at an ESD-protected workstation. If one is not available, you can provide some ESD protection by wearing an antistatic wrist strap attached to chassis ground of the server—any unpainted metal surface—when handling components.

CAUTION, use grounded outlet

Make sure that the power service connection is through a properly grounded outlet.

The server operates reliably within normal office environmental limits. Select a site that meets these criteria:

- Near a properly earthed, grounded, three-pronged power outlet
 - In the United States and Canada: a NEMA 6-15R outlet for 200-240 V~, or NEMA 5-15P for the 15 amp/125 V.
 - In other geographic areas: a properly earthed, grounded outlet in accordance with the local electrical authorities and electrical code of the region.
- Clean and relatively free of excess dust.
- Well-ventilated and away from sources of heat, with the ventilating openings on the server kept free of obstructions.
- Away from sources of vibration or physical shock.
- Isolated from strong electromagnetic fields and noise caused by electrical devices such as elevators, copy machines, air conditioners, large fans, large electric motors, radio and TV transmitters, and high-frequency security devices.
- Access space provided so the server power cords can be unplugged from the power supply or the wall outlet; this is the only way to remove AC power from the server.
- Clearance provided for cooling and airflow.

Optional Slide Rail Kit

If the SRPL8 Server is to be rack mounted the slide rail kit should be installed as follows before proceeding.

Equipment Rack Precautions

WARNINGS

ANCHOR THE EQUIPMENT RACK: The equipment rack must be anchored to an unmovable support to prevent it from falling over when one or more servers are extended in front of it on slide assemblies. The anchors must be able to withstand a force of up to 113 kg (250 lbs). You must also consider the weight of any other device installed in the rack.

MAIN AC POWER DISCONNECT: You are responsible for installing an AC power disconnect for the entire rack unit. This main disconnect must be readily accessible, and it must be labeled as controlling power to the entire unit, not just to the server(s).

GROUNDING THE RACK INSTALLATION: To avoid the potential for an electrical shock hazard, you must include a third wire safety grounding conductor with the rack installation. If a server power cord is plugged into an AC outlet that is part of the rack, then you must provide proper grounding for the rack itself. If server power cords are plugged into wall AC outlets, the safety grounding conductor in each power cord provides proper grounding only for the server. You must provide additional, proper grounding for the rack and other devices installed in it.

CAUTIONS

Temperature: The operating temperature of the server, when installed in an equipment rack, must not go below 5 °C (41 °F) or rise above 35 °C (95 °F). Extreme fluctuations in temperature can cause a variety of problems in your server.

Ventilation: The equipment rack must provide sufficient airflow to the front of the server to maintain proper cooling. It must also include ventilation sufficient to exhaust a maximum of 4,100 Btu's per hour for the server. The rack selected and the ventilation provided must be suitable to the environment in which the server will be used.

Prepare the Slide Assemblies

1. Remove the slide assemblies from the kit.
2. Orient the slide assembly so that the arrow embossed on each rail assembly is facing toward the front of the server as shown in Figure 2.



Figure 2. Slide Rail Orientation

3. Secure each slide rail to the server using 3 of the 8-32 csink screws as shown in Figure 3.



Figure 3. Slide Rail Mounting Screws

4. Fully extend the telescoping slide assembly until the center bar hits the safety latch on the small outer bar (all three overlapping bars will be visible).
5. Grasp the small outer bar (attached to the server) with your right hand so that your thumb is on the safety latch of the small outer bar.
6. Press and hold the safety latch down (see Figure 4), and at the same time, grasp the large outer bar with your left hand.



Figure 4. Small Rail Extension Release

7. Pull the small bar (attached to the server) out of the center bar; this takes a little force to separate them. Set the small bar aside to attach to the rack in a later step.
8. Orient the center bar and large outer bar assembly so that the center bar is facing up.
9. Grasp the center bar with your right hand and the large outer bar with your left hand so that your left-hand thumb is on the safety latch of the center bar.



Figure 5. Center Rail Extension Release

10. Press the safety latch, and separate the bars. Set the center bar and large outer bar assembly aside to attach to the equipment rack in a later step.
11. Prepare the other slide assembly by repeating steps 2–10 above.

Attach the Rail Slide Rail Brackets to the Equipment Rack

⇒ NOTE

Mounting holes in the vertical rails of equipment racks are commonly spaced in a 5/8 x 5/8 x 1/2-inch sequence. Perform the following steps carefully; brackets must be mounted with precision to allow room for the next server you install in a rack.

See Figure 6.

1. Remove a right-angle extension bracket, two screws, and a bar nut from the kit.
2. While facing the front or back of the rack, orient the right-angle extension bracket so that the short side with the four mounting holes is facing toward the outside edge of the vertical rail.
3. Position the bracket behind the mounting holes in the vertical rail.

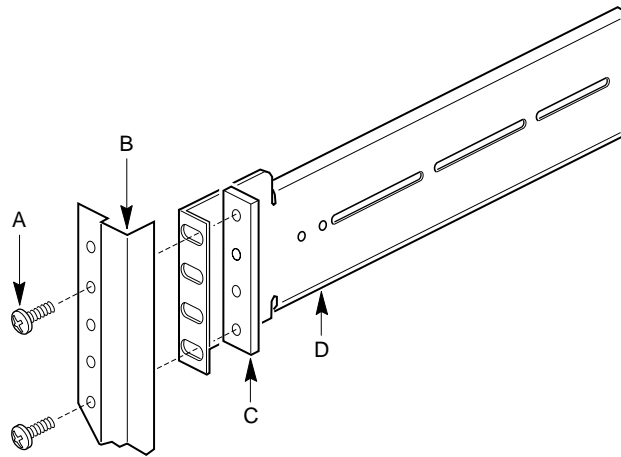

OM11071

Figure 6. Right-angle Bracket and Vertical Rail

- A. Screw
- B. Vertical rail
- C. Bar nut
- D. Right-angle extension bracket

4. With a pencil, mark the top and bottom hole locations of the bracket on both sides of the vertical rail; no hole numbers are printed on the rail.
5. Insert a screw through the marked top hole in the rail and through the top hole in the bracket. Place a bar nut on the screw and loosely tighten it. Repeat for the marked bottom hole.
6. Install the three remaining right-angle extension brackets on the other three vertical rails by repeating steps 1–5 above.

Attach the Center Bar and Large Outer Bar Assemblies to the Equipment Rack

See Figure 7.

1. Orient a center bar and large outer bar assembly so that the flat side is facing toward the brackets attached to the vertical rails and the safety latch on the center bar is near the back of the rack.
2. Press the flat side of the outer bar into the U-shaped sections of the brackets.
3. Slide the assembly toward the front of the rack until the end of the outer bar is flush with the end of the U-shaped section of the front bracket.
4. Gently slide the center bar toward the front of the rack, and position the oblong slot in it over the first hole in the large outer bar. Insert a screw through the hole in the bar and the first hole in the front bracket. Place a lock washer and a nut on the screw, and loosely tighten it.
5. Position the oblong slot in the center bar over the third hole back from the front of the large outer bar. Insert an 8-32 screw through the hole and the oblong slot in the front bracket. Place a lock washer and an 8-32 nut on the screw, and loosely tighten it.
6. The back bracket has two holes and three slots in it. This end of the outer bar has four holes in it. Which holes and slots you use depend on the depth of the equipment rack. After fitting the bar into the bracket, insert two screws through the holes in the bar and the appropriate oblong slots in the bracket. Place a lock washer and a nut on each screw, and loosely tighten them.
7. Ensure that the brackets and bars are positioned correctly in the rack. Then tighten all screws firmly (6.0 inch-pounds).

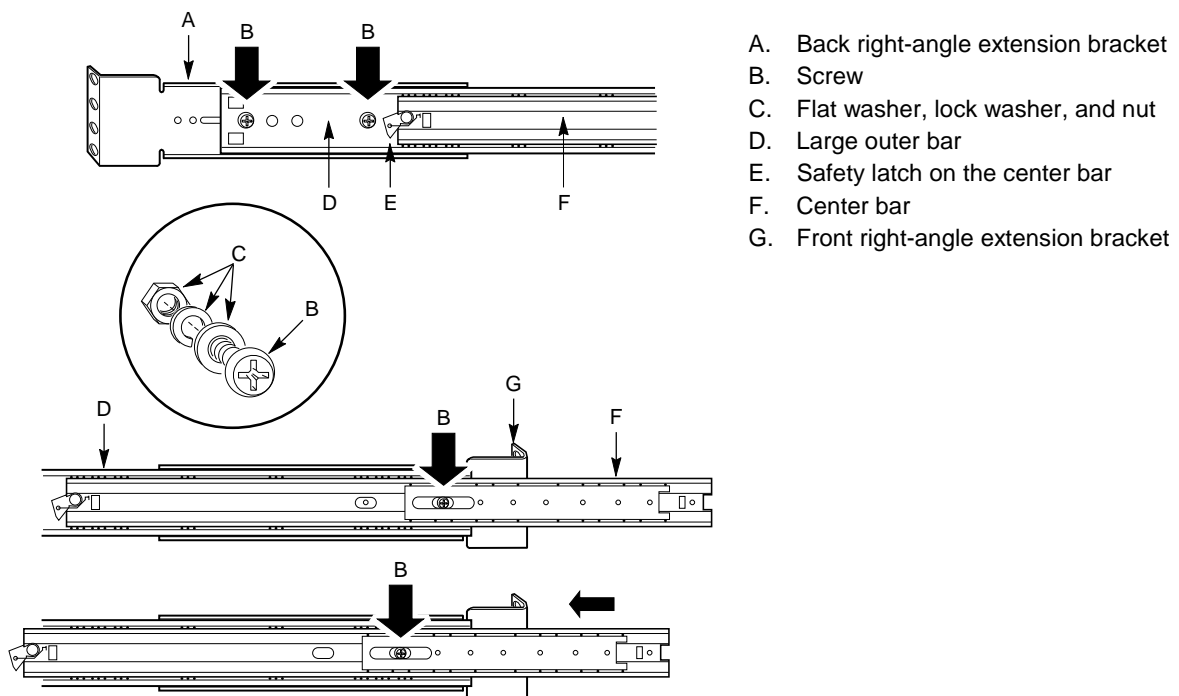

OM11072

Figure 7. Center Bar and Large Outer Bar Assembly

Install the Server in the Rack

WARNINGS

ANCHOR THE EQUIPMENT RACK: The equipment rack must be anchored to an unmovable support to prevent it from falling over when one or more servers are extended in front of it on slide assemblies. The anchors must be able to withstand a force of up to 113 kg (250 lbs). You must also consider the weight of any other device installed in the rack.

AVOID INJURY: To avoid personal injury when unpacking the server, use only a mechanical assist unit to lift it off the shipping pallet. The minimum server configuration weighs 51 kg (113 lbs); the maximum weighs 63.5 kg (140 lbs).

Use only a hand-truck or other mechanical assist unit to move the server from one location to another.

See Figure 8.

1. Pull the telescoping center bars out of the large outer bars until they are fully extended and locked in place.
2. Use a mechanical assist unit to carefully pick up the server; gently slide the small bars attached to each side of the server into the extended center bars.
3. When the server stops, press in on the safety latches on the small bars and gently slide the server into the rack.
4. Connect all external cables and the power cord to the server.

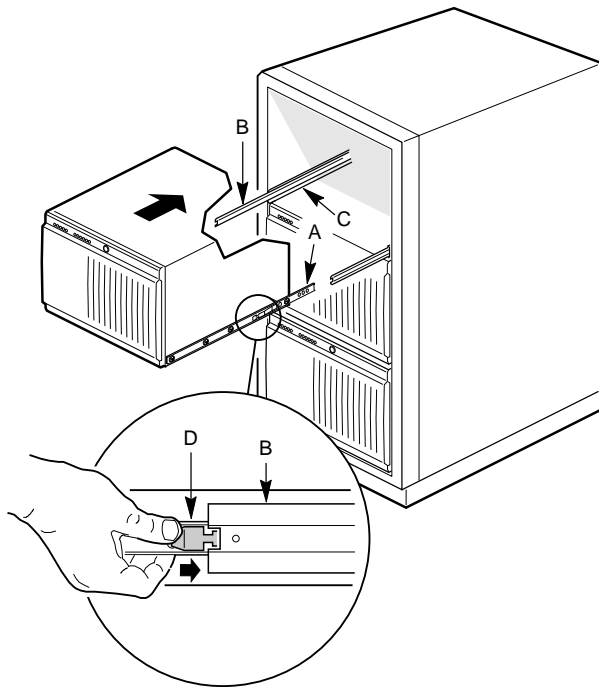

- A. Small outer bar
- B. Center bar
- C. Large outer bar
- D. Safety latch

OM11073

Figure 8. Installing the Server in the Rack

Check Power Cord

WARNING

Do not modify or use a supplied AC power cord if it is not the exact type required in the region where the server will be installed and used. Replace the cord with the correct type. Refer to the cord requirements described below.

Do not plug in the server power cord yet if you will be adding internal parts (boards, DIMMs, removable media drives). (For these installation procedures, see the *Product Guide*.)

Power Cord Requirements

- **Rating:** Cords must be rated for available AC voltage and have a current rating at least 125% of current rating of server.
- **Connector, wall outlet end:** Cords must be terminated in grounding-type male plug designed for use in your region. It must have certification marks showing certification by an agency acceptable in your region.
- **Connector, server end:** The connector that plugs into the AC receptacle on the server must be an IEC 320, sheet C19, type female connector.

- **Cord length and flexibility:** Cords must be less than 4.5 meters (14.76 feet) long, and must be flexible (harmonized <HAR>) cord or VDE-certified cordage to comply with server's safety certifications.

⇒ NOTES

Surge suppressor recommended: In geographic regions that are susceptible to electrical storms, we highly recommend that you plug the server into a surge suppressor.

Install power cord with or without retention mechanism: On the interior chassis wall beneath the external power connector, three hexagonal pegs form a retention mechanism. When you route the power cord between the hexagonal pegs, the cord cannot be pulled accidentally from the back of the server. We recommend you use the retention mechanism, but you do not NEED to. To access the retention mechanism, remove the left power supply (see Chapter 4 in the server *Product Guide*).

For EMI information, see the *Product Guide*: For information about complying with electromagnetic interference regulations, see “Electromagnetic Compatibility” in the server *Product Guide*.

To view or print the *Product Guide*: See “The Server Product Guide” on page 20 in this *Quick Start Guide*.

Connect Monitor, Keyboard, Mouse

⚠ CAUTION, unplug server

Before connecting external devices, make sure the server is not plugged in, or equipment could be damaged.

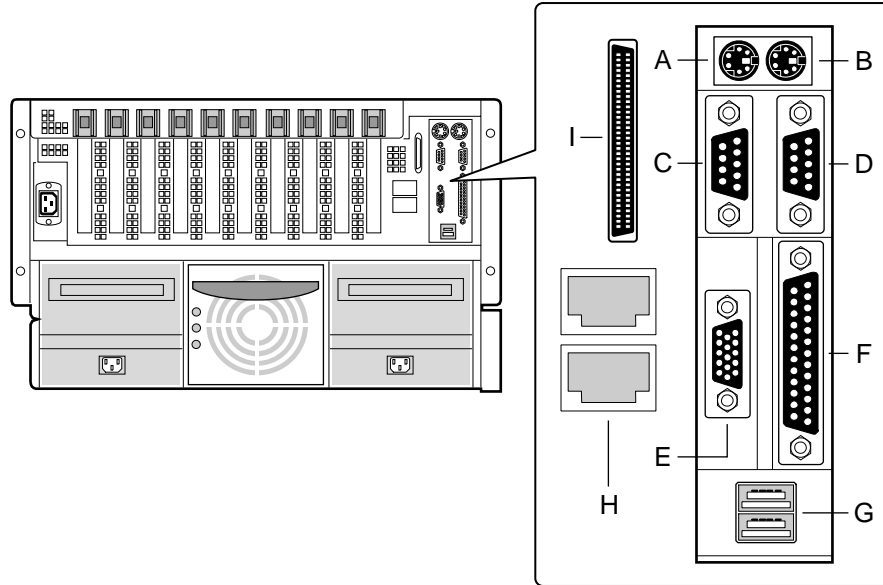

OM08782

Figure 9. Chassis Back View

Table 2. Back Components, Controls, and Indicators

Item	Feature/Description
A.	PCI add-in board expansion slots
B.	External LVDS connector
C.	PS/2 [†] -compatible keyboard/mouse port, 6-pin
D.	PS/2-compatible keyboard/mouse port, 6-pin
E.	PS/2-compatible serial ports A and B, 9-pin RS-232 connector
F.	Super VGA compatible, 15-pin video connector
G.	PS/2-compatible parallel port (LPT), 25-pin bidirectional subminiature D connector
H.	USB ports 0 and 1, 4-pin connector
I.	Interchassis Management Bus (ICMB) connectors port 1 and 2

continued

Table 2. Back Components, Controls, and Indicators (continued)

Item	Feature/Description
J.	Power Supplies (in this view, supplies must be populated from left to right; the right bay would contain the redundant supply)
K.	Failure LED (yellow)
L.	Predictive failure LED (yellow) for power supply fan
M.	Power LED (green)
N.	AC input power connector

Turn on Video Monitor and Server

1. Make sure all external devices, such as a monitor, keyboard, and mouse, have been connected.
2. Remove drive protection card (if present) from the diskette drive.
3. Turn on the video monitor.
4. Plug the female end of the server AC power cord into the input receptacle on the back of the chassis.
5. Plug the male end of the server AC power cord into a wall outlet (a grounded, three-pronged AC power outlet; see page 6 for outlet information).
6. If the server does not come on when you plug it into the AC outlet, press the push-button on/off power switch on the front panel.
7. Verify that the power-on light on the front panel is lit. After a few seconds, the power-on self test (POST) begins.

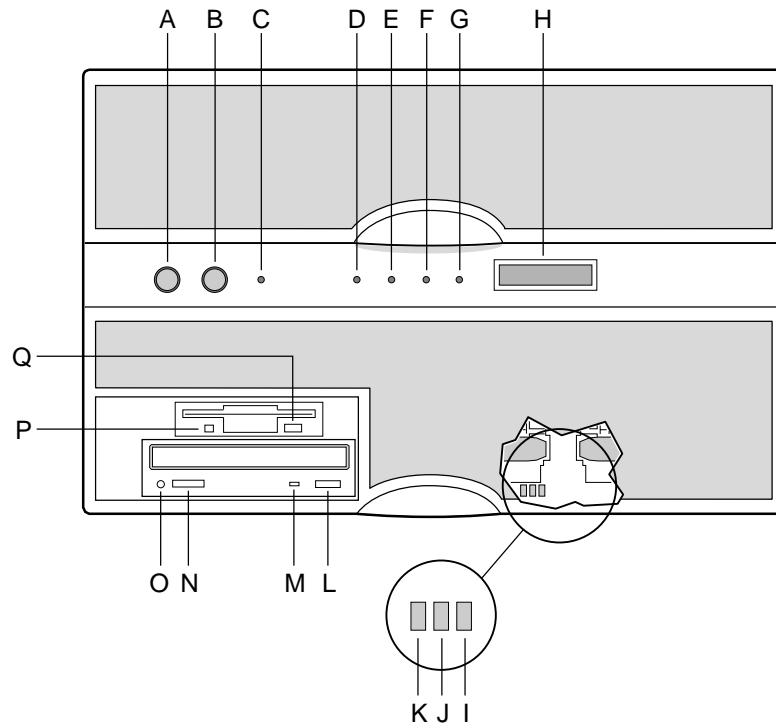

OM07301

Figure 10. Front Controls and Indicators

Table 3. Front Controls and Indicators

Item	Feature	Description
Front Panel		
A.	Power switch	When pressed, it turns on or off the server. The +5 V standby voltage is ON whenever the server is plugged in.
B.	Reset switch	When pressed, it resets the server and causes the power-on self test (POST) to run.
C.	NMI switch	When pressed, it causes a nonmaskable interrupt. This switch is recessed behind the front panel to prevent inadvertent activation. It must be pressed with a narrow tool (not supplied).
D.	Power LED (green)	When lit continuously, it indicates the presence of DC power in the server. When not lit, it indicates power is turned off or power source is disrupted.
E.	Power fault LED (yellow)	When lit continuously, it indicates a power supply failure.
F.	Cooling fault LED (yellow)	When flashing, it indicates a fan failure.
G.	Drive fault LED (yellow)	When lit continuously, it indicates an asserted fault status on one or more hard disk drives in the hot-docking bay. When flashing, it indicates drive reset in progress.
H.	Front panel LCD	Displays information about processor type and failure codes.
Status LEDs for SCSI Drives in Hot-docking Bays		
I.	Drive power LED (green)	When lit continuously, it indicates the presence of the drive and power on the drive.
J.	Drive activity LED (green)	Indicates drive activity.
K.	Drive fault LED (yellow)	When lit continuously, it indicates an asserted fault status on one or more hard disk drives in the hot-docking bay. When flashing, it indicates drive reset in progress.
CD-ROM Drive		
L.	Open/close button	When pressed, it opens or closes the CD-ROM tray.
M.	Activity LED	When lit, it indicates the drive is in use.
N.	Volume control	It adjusts the volume of headphones or speakers.
O.	Headphone jack	It provides a connection for headphones or speakers.
3.5-inch Diskette (Floppy) Drive		
P.	Activity LED	When lit, it indicates the drive is in use.
Q.	Ejector button	When pressed, it ejects the diskette.

Run Power-on Self Test

Each time you turn on the system, POST starts running. POST checks the carriers, processors, memory, keyboard, and most installed peripheral devices. During the memory test, POST displays the amount of memory it is able to access and test. The length of time needed to test memory depends on the amount of memory installed. POST is stored in flash memory.

1. Turn on your video monitor and system. After a few seconds, POST begins to run.
2. After the memory test, these screen prompts and messages appear:

```
Mouse Detected
```

```
Keyboard Initialized
```

```
Press <F2> to enter Setup
```

3. If you do not press <F2> and do NOT have a device with an OS loaded, the above message remains for a few seconds while the boot process continues, and the system beeps once. Then this message appears:

```
Operating System not found
```

(To create software installation diskettes, see the printed *Quick Start Guide*.)

If you do not press <F2>, the boot process continues and this message appears:

```
Press <Ctrl><C> to enter SCSI Utility
```

4. Press <Ctrl+C> if SCSI devices are installed. When the utility opens, follow the displayed instructions to configure the onboard SCSI host adapter settings and to run the SCSI utilities. Also see “Using the Symbios[†] SCSI Utility” in the *Product Guide*. If you do not enter the SCSI utility, the boot process continues.
5. Press <Esc> during POST to access a boot menu when POST finishes. From this menu, you can choose the boot device or enter BIOS Setup.

After POST completes, the system beeps once.

What appears next on the screen depends on if you have an OS loaded on the server (or which OS).

Boot from CD

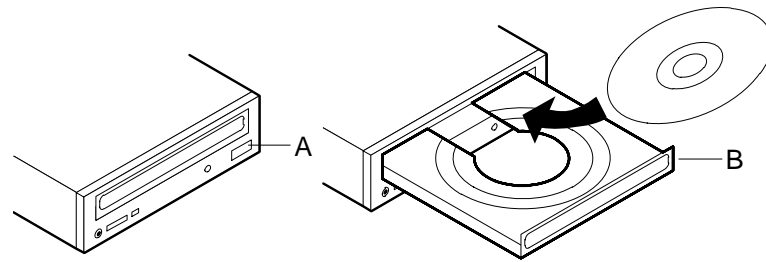

OM05063

Figure 10. Typical CD-ROM Drive

- A. Open/close push-button switch
- B. CD tray, CD with label side up



CAUTION, handle CD only by the edges

Handle the CD by its inner and outer edges. Do not touch the side **without** the label (the data side).



CAUTION, CD contains only a limited OS

The CD contains a limited OS with enough function to let you boot from the CD and copy and use the utility and manual files from the CD.

But this limited OS is *NOT* intended to be copied onto diskettes or onto your hard disk as a full-function OS that supports networking or Windows[†]. To run your server and applications, you must buy the OS of your choice and install it on the server.

⇒ NOTE

The server was shipped with the diskette drive set as the first boot device. The server will, therefore, try to boot from diskette rather than from the CD-ROM. Even with the CD in the drive, the server might continue to display “Operating System Not Found.” Follow the steps in “Change Boot Device Priority” on page 20.

1. Open the CD tray by pressing the open/close button on the front panel of the CD-ROM drive. The tray will slide out of the drive.
2. Open the CD case. Press down on the center hub of the case to release the CD.
3. Gently grasp the center hole and outer edge of the CD. Remove it from the case, and place it **label-side up** in the CD tray.
4. Press the open/close button or gently push on the CD tray—it will automatically slide into the drive.
5. Push the reset switch on the front panel to restart the server.
6. When POST completes, the server boots from the CD, installs a mouse driver, and displays the CD-ROM menu bar. Use the arrow keys to scroll through the menu bar and to view the tasks in the pop-up menus.

Change Boot Device Priority

You have two choices for changing boot device priority. The easier option (listed first, below) is good for only one boot; the longer option takes effect until you change boot device priority again.

1. At any time during POST, press <Esc>. When POST completes, a pop-up Boot menu appears.
2. Use the arrow keys to highlight Removable Media, then press <Enter>.

OR

1. Boot the server. The CD can be in the drive or not.
2. The BIOS name and version will display. Immediately below, you'll see the size of memory detected in the server.
3. Quickly press the <F2> key (a prompt to do this may or may not appear). After a few bootup tests complete, the main BIOS Setup screen appears.
4. From the Setup screen, select Boot Menu. Press <Enter>.
5. Select Boot Device Priority, and press <Enter>.
6. In the Boot Device Priority screen, use the up- or down-arrow keys to select Removable Media, then press the <+> key to move it to the top of the list.
7. Now set the second boot device to Diskette Drive and the third boot device to Hard Drive.
8. Press the <F10> key to save your changes and exit Setup.
9. When the Exit prompt appears, press <Enter> again.
10. The bootup process continues. When finished, an OS prompt displays.
11. Make sure the CD is in the drive, and boot the server.

The Server Product Guide

We provide the *SRPL8 Server System Product Guide* file on the CD. Because printing from within Acrobat is time-consuming, we recommend printing only a small range of pages for immediate use.

Using the Acrobat .PDF Files

The Adobe[†] Acrobat[†] Reader is shipped on the CD. Before you can print the *Product Guide* from Acrobat, you must connect a printer to the parallel port.

1. From the CD-ROM menu bar, select Read/Print Manuals and press <Enter>. The Adobe Acrobat reader will be automatically installed on RAM disk d: (simulated disk drive in RAM memory) and automatically started. The reader lets you view and print out a copy of the server *Product Guide*.
2. After the reader starts, a pop-up menu displays a list of several manuals. If you are not sure which manual applies to your server, check the title page of this *Quick Start Guide* for the correct product reference.
3. The menu also includes a manual for SCSI devices in the server.
4. Use your mouse or the up- and down-arrow keys to select the manual. Double click the left mouse button or press <Enter> to load the .PDF file for the manual.
5. Use your mouse or the tab key to select the .PDF file for the manual. Double click the left mouse button or press an arrow key and <Enter> to view the .PDF file.
6. Follow the program options and prompts. If you need to access the Help menu, double click on Help or press <Alt+h>.

Copy Configuration Software to Diskettes

When you copy software from the CD onto diskettes, device drivers suitable for several different OSs are copied onto the diskettes. However, your OS will read only those drivers it can recognize, so you cannot usually check the directory of a diskette that is not formatted for your OS. Instead, you might see a message to the effect, “disk not formatted, do you want to format it now?” Don’t worry; the drivers for YOUR OS are on the diskette and available to load on the system.

1. Before starting, make sure that you have several blank high-density diskettes.
2. From the CD-ROM menu bar, select Create Diskettes and press <Enter>.
3. Follow the prompts to copy the software onto the diskettes.
4. When finished, from the CD-ROM menu bar, select Quit to DOS and press <Enter>.
5. Remove the CD from the CD-ROM drive.

Warnings

WARNING: English

AVERTISSEMENT: Français

WARNUNG: Deutsch

AVVERTENZA: Italiano

ADVERTENCIAS: Español

WARNING: English (US)

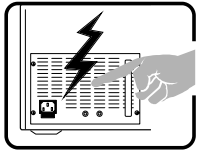
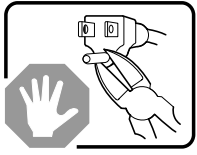
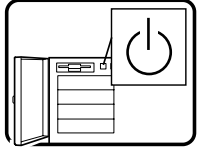
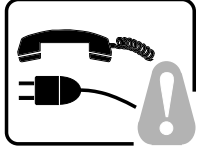
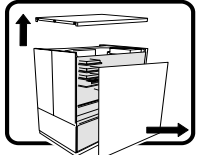
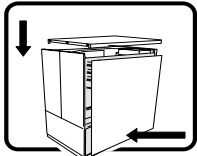
	<p>The power supply in this product contains no user-serviceable parts. There may be more than one supply in this product. Refer servicing only to qualified personnel.</p>
	<p>Do not attempt to modify or use the supplied AC power cord if it is not the exact type required. A product with more than one power supply will have a separate AC power cord for each supply.</p> <p>Do not attempt to modify or use the supplied AC power cord if it is not the exact type required.</p>
	<p>The DC push-button on/off switch on the system does not turn off system AC power. To remove AC power from the system, you must unplug each AC power cord from the wall outlet or power supply.</p> <p>The DC push-button on/off switch on the system does not turn off system AC power. To remove AC power from the system, you must unplug the AC power cord from the wall outlet or power supply.</p>
	<p>SAFETY STEPS: Whenever you remove the chassis covers to access the inside of the system, follow these steps:</p> <ol style="list-style-type: none">1. Turn off all peripheral devices connected to the system.2. Turn off the system by using the push-button on/off power switch on the system.3. Unplug all AC power cords from the system or from wall outlets.4. Label and disconnect all cables connected to I/O connectors or ports on the back of the system.5. Provide some electrostatic discharge (ESD) protection by wearing an antistatic wrist strap attached to chassis ground of the system—any unpainted metal surface—when handling components.6. Do not operate the system with the chassis covers removed.
	<p>After you have completed the six SAFETY steps above, you can remove the system covers. To do this:</p> <ol style="list-style-type: none">1. Unlock and remove the padlock from the back of the system if a padlock has been installed.2. Remove and save all screws from the covers.3. Remove the covers.
	<p>For proper cooling and airflow, always reinstall the chassis covers before turning on the system. Operating the system without the covers in place can damage system parts. To install the covers:</p> <ol style="list-style-type: none">1. Check first to make sure you have not left loose tools or parts inside the system.2. Check that cables, add-in boards, and other components are properly installed.3. Attach the covers to the chassis with the screws removed earlier, and tighten them firmly.4. Insert and lock the padlock to the system to prevent unauthorized access inside the system.5. Connect all external cables and the AC power cord(s) to the system.

continued

WARNING: English (continued)

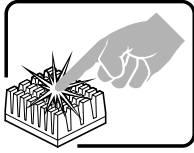
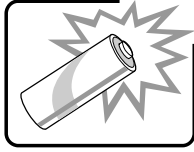
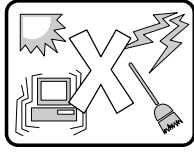
	<p>A microprocessor and heat sink may be hot if the system has been running. Also, there may be sharp pins and edges on some board and chassis parts. Contact should be made with care. Consider wearing protective gloves.</p>
	<p>Danger of explosion if the battery is incorrectly replaced. Replace only with the same or equivalent type recommended by the equipment manufacturer. Discard used batteries according to manufacturer's instructions.</p>
	<p>The system is designed to operate in a typical office environment. Choose a site that is:</p> <ul style="list-style-type: none">• Clean and free of airborne particles (other than normal room dust).• Well-ventilated and away from sources of heat including direct sunlight.• Away from sources of vibration or physical shock.• Isolated from strong electromagnetic fields produced by electrical devices.• In regions that are susceptible to electrical storms, we recommend you plug your system into a surge suppresser and disconnect telecommunication lines to your modem during an electrical storm.• Provided with a properly grounded wall outlet.• Provided with sufficient space to access the power supply cords, because they serve as the product's main power disconnect.• Provided with sufficient space to access the server power supply cord, because it serves as the product's main power disconnect.

AVERTISSEMENT: Français

	<p>Le bloc d'alimentation de ce produit ne contient aucune pièce pouvant être réparée par l'utilisateur. Ce produit peut contenir plus d'un bloc d'alimentation. Veuillez contacter un technicien qualifié en cas de problème.</p>
	<p>Ne pas essayer d'utiliser ni modifier le câble d'alimentation CA fourni, s'il ne correspond pas exactement au type requis. Le nombre de câbles d'alimentation CA fournis correspond au nombre de blocs d'alimentation du produit. N'essayez pas de modifier ou utiliser la corde fournie de courant alternatif Si ce n'est pas le type exact exigé.</p>
	<p>Notez que le commutateur CC de mise sous tension /hors tension du panneau avant n'éteint pas l'alimentation CA du système. Pour mettre le système hors tension, vous devez débrancher chaque câble d'alimentation de sa prise. Le commutateur "Marche/Arrêt" à bouton-poussoir de C.C sur le système n'arrête pas le courant alternatif du système. Pour couper le courant alternatif Du système, vous devez débrancher la corde de courant alternatif De la prise murale ou de l'alimentation d'énergie.</p>
	<p>CONSIGNES DE SÉCURITÉ - Lorsque vous ouvrez le boîtier pour accéder à l'intérieur du système, suivez les consignes suivantes :</p> <ol style="list-style-type: none">1. Mettez hors tension tous les périphériques connectés au système.2. Mettez le système hors tension en mettant l'interrupteur général en position OFF (bouton-poussoir).3. Débranchez tous les cordons d'alimentation c.a. du système et des prises murales.4. Identifiez et débranchez tous les câbles reliés aux connecteurs d'E-S ou aux accès derrière le système.5. Pour prévenir les décharges électrostatiques lorsque vous touchez aux composants, portez une bande antistatique pour poignet et reliez-la à la masse du système (toute surface métallique non peinte du boîtier).6. Ne faites pas fonctionner le système tandis que le boîtier est ouvert.
	<p>Une fois TOUTES les étapes précédentes accomplies, vous pouvez retirer les panneaux du système. Procédez comme suit :</p> <ol style="list-style-type: none">1. Si un cadenas a été installé sur à l'arrière du système, déverrouillez-le et retirez-le.2. Retirez toutes les vis des panneaux et mettez-les dans un endroit sûr.3. Retirez les panneaux.
	<p>Afin de permettre le refroidissement et l'aération du système, réinstallez toujours les panneaux du boîtier avant de mettre le système sous tension. Le fonctionnement du système en l'absence des panneaux risque d'endommager ses pièces. Pour installer les panneaux, procédez comme suit :</p> <ol style="list-style-type: none">1. Assurez-vous de ne pas avoir oublié d'outils ou de pièces démontées dans le système.2. Assurez-vous que les câbles, les cartes d'extension et les autres composants sont bien installés.3. Revissez solidement les panneaux du boîtier avec les vis retirées plus tôt.4. Remettez le cadenas en place et verrouillez-le afin de prévenir tout accès non autorisé à l'intérieur du système.5. Rebranchez tous les cordons d'alimentation c. a. et câbles externes au système.

suite

AVERTISSEMENT: Français (suite)

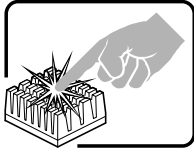
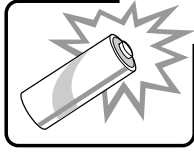
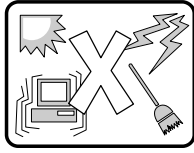
	<p>Le microprocesseur et le dissipateur de chaleur peuvent être chauds si le système a été sous tension. Faites également attention aux broches aiguës des cartes et aux bords tranchants du capot. Nous vous recommandons l'usage de gants de protection.</p>
	<p>Danger d'explosion si la batterie n'est pas remontée correctement. Remplacer uniquement avec une batterie du même type ou d'un type équivalent recommandé par le fabricant. Disposez des piles usées selon les instructions du fabricant.</p>
	<p>Le système a été conçu pour fonctionner dans un cadre de travail normal. L'emplacement choisi doit être :</p> <ul style="list-style-type: none">• Propre et dépourvu de poussière en suspension (sauf la poussière normale).• Bien aéré et loin des sources de chaleur, y compris du soleil direct.• A l'abri des chocs et des sources de vibrations.• Isolé de forts champs électromagnétiques générés par des appareils électriques.• Dans les régions sujettes aux orages magnétiques il est recommandé de brancher votre système à un supresseur de surtension, et de débrancher toutes les lignes de télécommunications de votre modem durant un orage.• Muni d'une prise murale correctement mise à la terre.• Suffisamment spacieux pour vous permettre d'accéder aux câbles d'alimentation (ceux-ci étant le seul moyen de mettre le système hors tension).• Fourni en suffisamment d'espace pour accéder à la corde d'alimentation d'énergie de serveur, parce qu'elle sert de débranchement de la puissance principale du produit.

WARNUNG: Deutsch

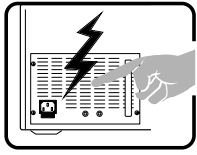
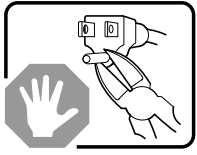
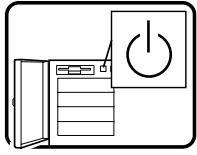
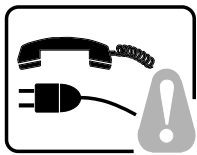
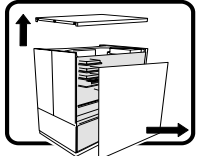
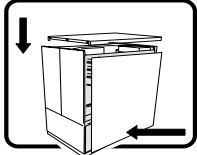
	<p>Benutzer können am Netzgerät dieses Produkts keine Reparaturen vornehmen. Das Produkt enthält möglicherweise mehrere Netzgeräte. Wartungsarbeiten müssen von qualifizierten Technikern ausgeführt werden.</p>
	<p>Versuchen Sie nicht, das mitgelieferte Netzkabel zu ändern oder zu verwenden, wenn es sich nicht genau um den erforderlichen Typ handelt. Ein Produkt mit mehreren Netzgeräten hat für jedes Netzgerät ein eigenes Netzkabel.</p> <p>Versuchen Sie nicht, das mitgelieferte Netzkabel zu verändern oder einzusetzen, wenn es nicht ganz genau dem benötigten Kabeltyp entspricht.</p>
	<p>Der Wechselstrom des Systems wird durch den Ein-/Aus-Schalter für Gleichstrom nicht ausgeschaltet. Ziehen Sie jedes Wechselstrom-Netzkabel aus der Steckdose bzw. dem Netzgerät, um den Stromanschluß des Systems zu unterbrechen.</p> <p>Der Gleichstromschalter, der sich am System befindet, trennt das System nicht von der Netzversorgung. Um das System vom Netz zu trennen, müssen Sie das Netzkabel aus der Steckdose oder vom Netzteil ziehen.</p>
	<p>SICHERHEITSMASSNAHMEN: Immer wenn Sie die Gehäuseabdeckung abnehmen um an das Systeminnere zu gelangen, sollten Sie folgende Schritte beachten:</p> <ol style="list-style-type: none">1. Schalten Sie alle an Ihr System angeschlossenen Peripheriegeräte aus.2. Schalten Sie das System mit dem Hauptschalter aus.3. Ziehen Sie den Stromanschlußstecker Ihres Systems aus der Steckdose.4. Auf der Rückseite des Systems beschriften und ziehen Sie alle Anschlußkabel von den I/O Anschlüssen oder Ports ab.5. Tragen Sie ein geerdetes Antistatik Gelenkband, um elektrostatische Ladungen (ESD) über blanke Metallstellen bei der Handhabung der Komponenten zu vermeiden.6. Schalten Sie das System niemals ohne ordnungsgemäß montiertes Gehäuse ein.
	<p>Nachdem Sie die oben erwähnten ersten sechs SICHERHEITSSCHRITTE durchgeführt haben, können Sie die Abdeckung abnehmen, indem Sie:</p> <ol style="list-style-type: none">1. Öffnen und entfernen Sie die Verschlusseinrichtung (Padlock) auf der Rückseite des Systems, falls eine Verschlusseinrichtung installiert ist.2. Entfernen Sie alle Schrauben der Gehäuseabdeckung.3. Nehmen Sie die Abdeckung ab.
	<p>Zur ordnungsgemäßen Kühlung und Lüftung muß die Gehäuseabdeckung immer wieder vor dem Einschalten installiert werden. Ein Betrieb des Systems ohne angebrachte Abdeckung kann Ihrem System oder Teile darin beschädigen. Um die Abdeckung wieder anzubringen:</p> <ol style="list-style-type: none">1. Vergewissern Sie sich, daß Sie keine Werkzeuge oder Teile im Innern des Systems zurückgelassen haben.2. Überprüfen Sie alle Kabel, Zusatzkarten und andere Komponenten auf ordnungsgemäßen Sitz und Installation.3. Bringen Sie die Abdeckungen wieder am Gehäuse an, indem Sie die zuvor gelösten Schrauben wieder anbringen. Ziehen Sie diese gut an.4. Bringen Sie die Verschlusseinrichtung (Padlock) wieder an und schließen Sie diese, um ein unerlaubtes Öffnen des Systems zu verhindern.5. Schließen Sie alle externen Kabel und den AC Stromanschlußstecker Ihres Systems wieder an.

fortsetzung

WARNUNG: Deutsch (fortsetzung)

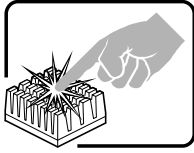
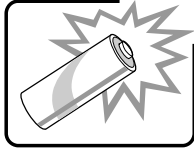
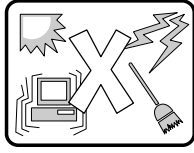
	<p>Der Mikroprozessor und der Kühler sind möglicherweise erhitzt, wenn das System in Betrieb ist. Außerdem können einige Platinen und Gehäuseteile scharfe Spitzen und Kanten aufweisen. Arbeiten an Platinen und Gehäuse sollten vorsichtig ausgeführt werden. Sie sollten Schutzhandschuhe tragen.</p>
	<p>Bei falschem Einsetzen einer neuen Batterie besteht Explosionsgefahr. Die Batterie darf nur durch denselben oder einen entsprechenden, vom Hersteller empfohlenen Batterietyp ersetzt werden. Entsorgen Sie verbrauchte Batterien den Anweisungen des Herstellers entsprechend.</p>
	<p>Das System wurde für den Betrieb in einer normalen Büroumgebung entwickelt. Der Standort sollte:</p> <ul style="list-style-type: none">• Sauber und staubfrei sein (Hausstaub ausgenommen);• gut gelüftet und keinen Heizquellen ausgesetzt sein (einschließlich direkter Sonneneinstrahlung);• keinen Erschütterungen ausgesetzt sein;• keine starken, von elektrischen Geräten erzeugten elektromagnetischen Felder aufweisen;• in Regionen, in denen elektrische Stürme auftreten, mit einem Überspannungsschutzgerät verbunden sein; während eines elektrischen Sturms sollte keine Verbindung der Telekommunikationsleitungen mit dem Modem bestehen;• mit einer geerdeten Wechselstromsteckdose ausgerüstet sein;• über ausreichend Platz verfügen, um Zugang zu den Netzkabeln zu gewährleisten, da der Stromanschluß des Produkts hauptsächlich über die Kabel unterbrochen wird.• versehen mit genügendem Platz, um das Server Spg.Versorgungsteilnetzkabel zuzugreifen, weil es.

AVVERTENZA: Italiano

	<p>Rivolgersi ad un tecnico specializzato per la riparazione dei componenti dell'alimentazione di questo prodotto. È possibile che il prodotto disponga di più fonti di alimentazione.</p>
	<p>Non modificare o utilizzare il cavo di alimentazione in c.a. fornito dal produttore, se non corrisponde esattamente al tipo richiesto. Ad ogni fonte di alimentazione corrisponde un cavo di alimentazione in c.a. separato.</p> <p>Non tentare di modificare o utilizzare il cavo di alimentazione in c.a. in dotazione, se non è esattamente del tipo richiesto.</p>
	<p>L'interruttore attivato/disattivato nel pannello anteriore non interrompe l'alimentazione in c.a. del sistema. Per interromperla, è necessario scollegare tutti i cavi di alimentazione in c.a. dalle prese a muro o dall'alimentazione di corrente.</p> <p>Il pulsante di Accensione/spengimento della corrente continua sul sistema non interrompe l'alimentazione in c.a. del sistema. Per scollegare anche l'alimentazione in c.a., è necessario disinserire il cavo di alimentazione in c.a. dalla presa a muro o dall'alimentatore.</p>
	<p>PASSI DI SICUREZZA: Qualora si rimuovano le coperture del telaio per accedere all'interno del sistema, seguire i seguenti passi:</p> <ol style="list-style-type: none">1. Spegner tutti i dispositivi periferici collegati al sistema.2. Spegner il sistema, usando il pulsante spento/acceso dell'interruttore del sistema.3. Togliere tutte le spine dei cavi del sistema dalle prese elettriche.4. Identificare e sconnettere tutti i cavi attaccati ai collegamenti I/O od alle prese installate sul retro del sistema.5. Qualora si tocchino i componenti, proteggersi dallo scarico elettrostatico (SES), portando un cinghia anti-statica da polso che è attaccata alla presa a terra del telaio del sistema – qualsiasi superficie non dipinta – .6. Non far operare il sistema quando il telaio è senza le coperture.
	<p>Dopo aver seguito i sei passi di SICUREZZA sopracitati, togliere le coperture del telaio del sistema come segue:</p> <ol style="list-style-type: none">1. Aprire e rimuovere il lucchetto dal retro del sistema qualora ve ne fosse uno installato.2. Togliere e mettere in un posto sicuro tutte le viti delle coperture.3. Togliere le coperture.
	<p>Per il giusto flusso dell'aria e raffreddamento del sistema, rimettere sempre le coperture del telaio prima di riaccendere il sistema. Operare il sistema senza le coperture al loro proprio posto potrebbe danneggiare i componenti del sistema. Per rimettere le coperture del telaio:</p> <ol style="list-style-type: none">1. Controllare prima che non si siano lasciati degli attrezzi o dei componenti dentro il sistema.2. Controllare che i cavi, dei supporti aggiuntivi ed altri componenti siano stati installati appropriatamente.3. Attaccare le coperture al telaio con le viti tolte in precedenza e avvitarle strettamente.4. Inserire e chiudere a chiave il lucchetto sul retro del sistema per impedire l'accesso non autorizzato al sistema.5. Ricollegare tutti i cavi esterni e le prolunghie AC del sistema.

continua

AVVERTENZA: Italiano (continua)

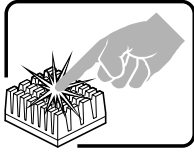
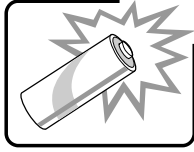
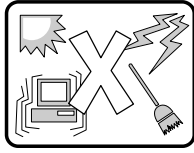
	<p>Se il sistema è stato a lungo in funzione, il microprocessore e il dissipatore di calore potrebbero essere surriscaldati. Fare attenzione alla presenza di piedini appuntiti e parti taglienti sulle schede e sul telaio. È consigliabile l'uso di guanti di protezione.</p>
	<p>Esiste il pericolo di un'esplosione se la pila non viene sostituita in modo corretto. Utilizzare solo pile uguali o di tipo equivalente a quelle consigliate dal produttore. Per disfarsi delle pile usate, seguire le istruzioni del produttore.</p>
	<p>Il sistema è progettato per funzionare in un ambiente di lavoro tipo. Scegliere una postazione che sia:</p> <ul style="list-style-type: none">• Pulita e libera da particelle in sospensione (a parte la normale polvere presente nell'ambiente).• Ben ventilata e lontana da fonti di calore, compresa la luce solare diretta.• Al riparo da urti e lontana da fonti di vibrazione.• Isolata dai forti campi magnetici prodotti da dispositivi elettrici.• In aree soggette a temporali, è consigliabile collegare il sistema ad un limitatore di corrente. In caso di temporali, scollegare le linee di comunicazione dal modem.• Dotata di una presa a muro correttamente installata.• Dotata di spazio sufficiente ad accedere ai cavi di alimentazione, i quali rappresentano il mezzo principale di scollegamento del sistema.• Fornito di uno spazio sufficiente ad accedere al cavo di alimentazione del server, poiché si tratta del modo principale per scollegare l'alimentazione del sistema.

ADVERTENCIAS: Español

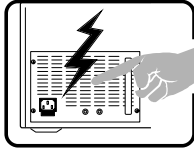
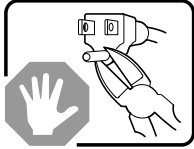
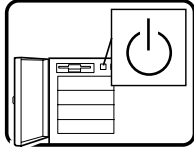
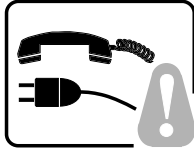
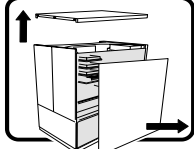
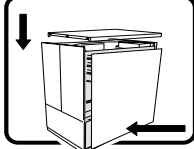
	<p>El usuario debe abstenerse de manipular los componentes de la fuente de alimentación de este producto, cuya reparación debe dejarse exclusivamente en manos de personal técnico especializado. Puede que este producto disponga de más de una fuente de alimentación.</p>
	<p>No intente modificar ni usar el cable de alimentación de corriente alterna, si no corresponde exactamente con el tipo requerido. El número de cables suministrados se corresponden con el número de fuentes de alimentación de corriente alterna que tenga el producto.</p>
	<p>Nótese que el interruptor activado/desactivado en el panel frontal no desconecta la corriente alterna del sistema. Para desconectarla, deberá desenchufar todos los cables de corriente alterna de la pared o desconectar la fuente de alimentación.</p>
	<p>INSTRUCCIONES DE SEGURIDAD: Cuando extraiga la tapa del chasis para acceder al interior del sistema, siga las siguientes instrucciones:</p> <ol style="list-style-type: none"> 1. Apague todos los dispositivos periféricos conectados al sistema. 2. Apague el sistema presionando el interruptor encendido/apagado. 3. Desconecte todos los cables de alimentación CA del sistema o de las tomas de corriente alterna. 4. Identifique y desconecte todos los cables enchufados a los conectores E/S o a los puertos situados en la parte posterior del sistema. 5. Cuando manipule los componentes, es importante protegerse contra la descarga electrostática (ESD). Puede hacerlo si utiliza una muñequera antiestática sujeta a la toma de tierra del chasis — o a cualquier tipo de superficie de metal sin pintar. 6. No ponga en marcha el sistema si se han extraído las tapas del chasis.
	<p>Después de completar las seis instrucciones de SEGURIDAD mencionadas, ya puede extraer las tapas del sistema. Para ello:</p> <ol style="list-style-type: none"> 1. Desbloquee y extraiga el bloqueo de seguridad de la parte posterior del sistema, si se ha instalado uno. 2. Extraiga y guarde todos los tornillos de las tapas. 3. Extraiga las tapas.
	<p>Para obtener un enfriamiento y un flujo de aire adecuados, reinstale siempre las tapas del chasis antes de poner en marcha el sistema. Si pone en funcionamiento el sistema sin las tapas bien colocadas puede dañar los componentes del sistema. Para instalar las tapas:</p> <ol style="list-style-type: none"> 1. Asegúrese primero de no haber dejado herramientas o componentes sueltos dentro del sistema. 2. Compruebe que los cables, las placas adicionales y otros componentes se hayan instalado correctamente. 3. Incorpore las tapas al chasis mediante los tornillos extraídos anteriormente, tensándolos firmemente. 4. Inserte el bloqueo de seguridad en el sistema y bloquéelo para impedir que pueda accederse al mismo sin autorización. 5. Conecte todos los cables externos y los cables de alimentación CA al sistema.

continúa

ADVERTENCIAS: Español (continúa)

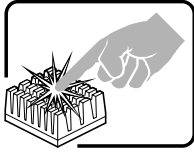
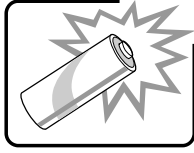
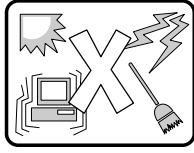
	<p>Si el sistema ha estado en funcionamiento, el microprocesador y el disipador de calor pueden estar aún calientes. También conviene tener en cuenta que en el chasis o en el tablero puede haber piezas cortantes o punzantes. Por ello, se recomienda precaución y el uso de guantes protectores.</p>
	<p>Existe peligro de explosión si la pila no se cambia de forma adecuada. Utilice solamente pilas iguales o del mismo tipo que las recomendadas por el fabricante del equipo. Para deshacerse de las pilas usadas, siga igualmente las instrucciones del fabricante.</p>
	<p>El sistema está diseñado para funcionar en un entorno de trabajo normal. Escoja un lugar:</p> <ul style="list-style-type: none">• Limpio y libre de partículas en suspensión (salvo el polvo normal).• Bien ventilado y alejado de fuentes de calor, incluida la luz solar directa.• Alejado de fuentes de vibración.• Aislado de campos electromagnéticos fuertes producidos por dispositivos eléctricos.• En regiones con frecuentes tormentas eléctricas, se recomienda conectar su sistema a un eliminador de sobrevoltage y desconectar el módem de las líneas de telecomunicación durante las tormentas.• Provisto de una toma de tierra correctamente instalada.• Provisto de espacio suficiente como para acceder a los cables de alimentación, ya que éstos hacen de medio principal de desconexión del sistema.

